

Compact Slide

ø6, ø10, ø16, ø20

New

RoHS

Allowable moment
Improved
by up to
240%

With new high rigidity
linear guide

Allowable moment improvement
illustrated below*

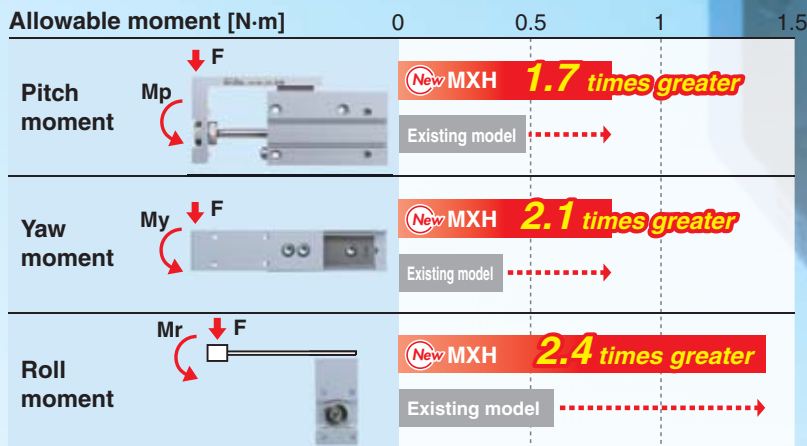

* Allowable moment caused by static load
(The above graph is a comparison between the new MXH and the existing MXH6.)



The weight has been reduced by incorporating
a new high rigidity linear guide and piston.



Series **MXH**



CAT.EUS20-218A-UK

High rigidity achieved with new circulating type linear guide

High allowable moment

Pitch Moment [N·m]

Bore size [mm]	New MXH	MXH existing model
6	0.81	0.47
10	1.69	0.96
16	3.49	1.88
20	5.86	3.14

Yaw Moment [N·m]

Bore size [mm]	New MXH	MXH existing model
6	0.81	0.39
10	1.69	0.82
16	3.49	1.59
20	5.86	2.75

Roll Moment [N·m]

Bore size [mm]	New MXH	MXH existing model
6	1.4	0.59
10	3.19	1.37
16	6.47	2.75
20	11.66	5.49

* Selection of a bore size cannot be made only with above allowable moment. Select a bore size in accordance with "Model Selection" on pages 2 and 3.

Traveling parallelism is the same as the existing model.

Deflection at the extended position of the table is the same as the existing model.

Traveling parallelism	Stroke [mm]	
	5 to 30	40 to 60
	0.05 mm or less	0.1 mm or less

* Values when no load and no pressure applied.

Small auto switches capable (D-M9□, D-A9□)

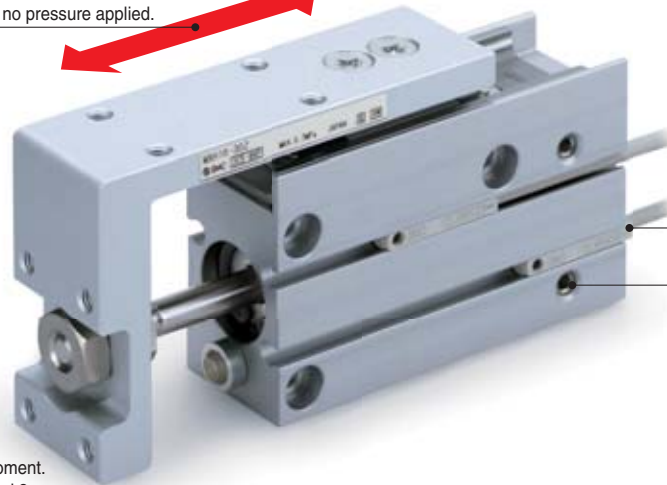

Mounting is completely interchangeable with existing model.

Dimensions including workpiece mounting dimensions and cylinder mounting dimensions are the same as the existing model.

Mounting is possible in 4 directions.

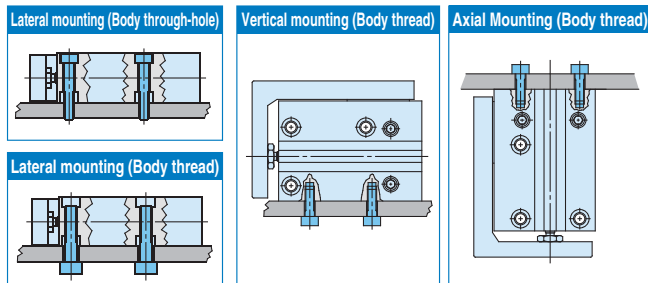

Piping is possible in 3 directions.

If changing the port location, "Made to Order" model (-XC3□) is available.

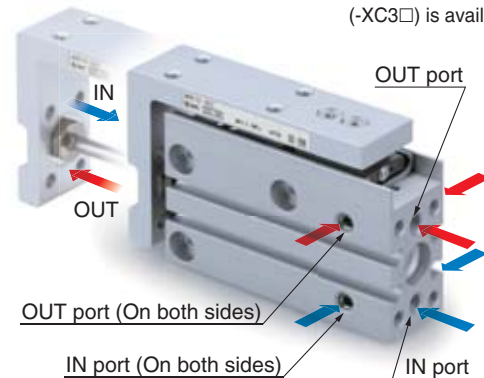

Application Example

Useful when there is a long distance to the work piece.

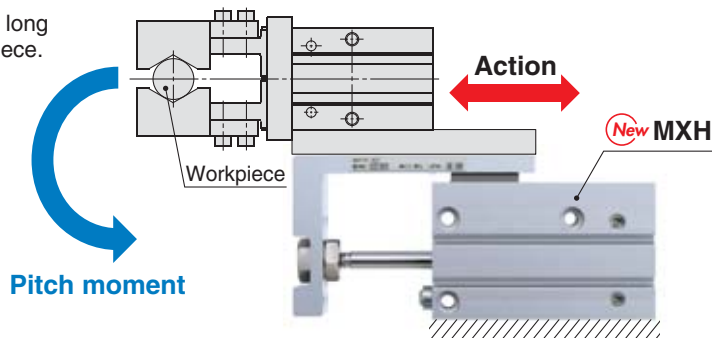

Series Variations

Model	Standard stroke [mm]										Made to Order
	5	10	15	20	25	30	40	50	60		
MXH6	●	●	●	●	●	●	●	●	●	●	-XC79 : Machining tapped hole, drilled hole and pin hole additionally -XB13 : Low speed cylinder (5 to 50 mm/s) -XC3□ : Special port location -XC19 : Intermediate stroke (Spacer type) -XC22 : Fluororubber seal
MXH10	●	●	●	●	●	●	●	●	●	●	
MXH16	●	●	●	●	●	●	●	●	●	●	
MXH20	●	●	●	●	●	●	●	●	●	●	

Series MXH Model Selection

⚠ Caution Confirmation of theoretical output is required separately. Refer to “Theoretical Output” on page 5.

Selection Conditions: Follow the tables below in order to determine selection conditions and choose one selection graph.

Mounting orientation	Vertical			Horizontal								
Maximum speed [mm/s]	Up to 100	Up to 300	Up to 500	Up to 100			Up to 300			Up to 500		
Load eccentricity L1 [mm]	—			50	100	200	50	100	200	50	100	200
Selection graph	1	2	3	4	5	6	7	8	9	10	11	12

* L: Overhang (the distance from the cylinder shaft centre to the load centre of gravity)
The direction of L can also be a diagonal direction. (Refer to the drawing at right.)
* H: Distance from the cylinder centre axis to the mounting surface for the table

	MXH6	MXH10	MXH16	MXH20
H dimension [mm]	24.5	30.5	34.5	41.5

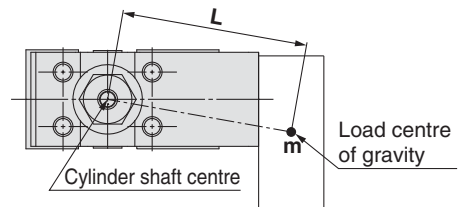

Selection Graph 1 to 3 (Vertical Mounting)

Graph 1 Maximum Speed 100 mm/s or Less

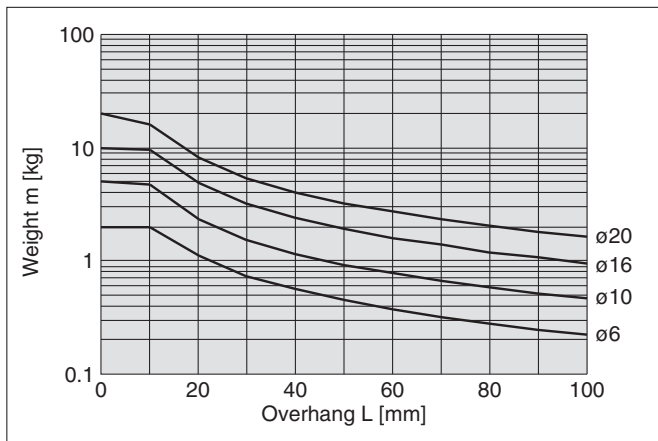

Graph 3 Maximum Speed 500 mm/s or Less

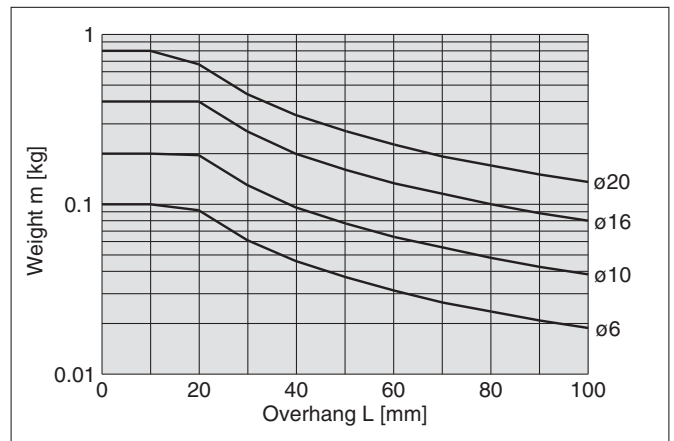

Graph 2 Maximum Speed 300 mm/s or Less

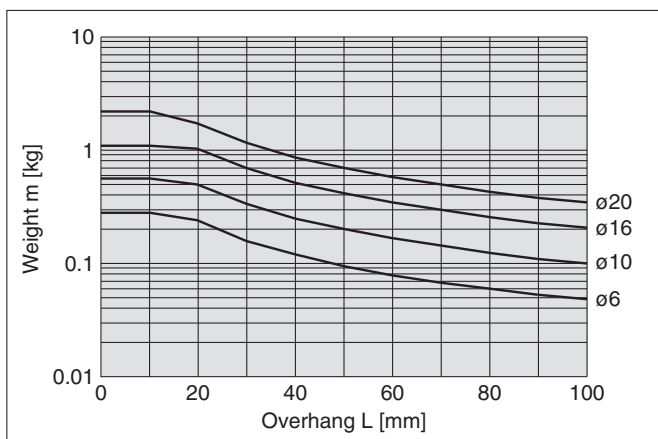

Selection Example (Vertical Mounting)

1. Selection conditions
- Mounting: Vertical
 - Maximum speed: 500 mm/s
 - Overhang L: 40 mm
 - Load weight m: 0.1 kg

Refer to Graph 3 based on vertical mounting and a speed of 500 mm/s.
In Graph 3, find the intersection of a 40 mm overhang L and load weight m of 0.1 kg, which results in a determination of ø16.

Series MXH

Selection Graph 4 to 12 (Horizontal Mounting)

Maximum Speed 100 mm/s or Less

Graph 4 Load Eccentricity 50 mm

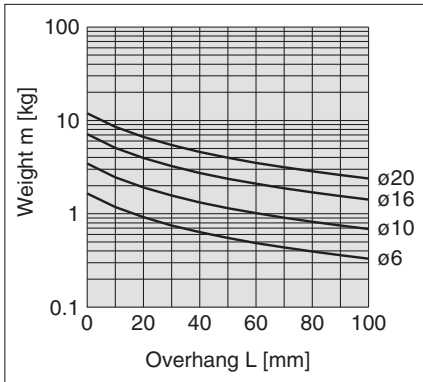

Maximum Speed 300 mm/s or Less

Graph 7 Load Eccentricity 50 mm

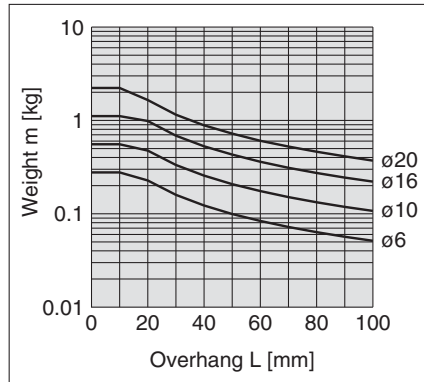

Maximum Speed 500 mm/s or Less

Graph 10 Load Eccentricity 50 mm

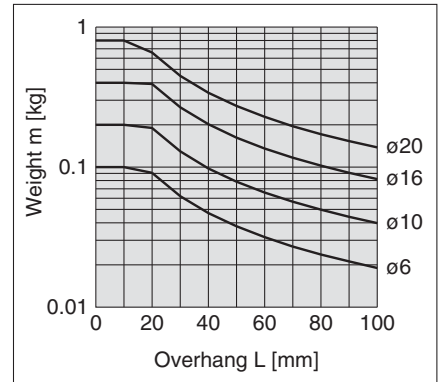

Graph 5 Load Eccentricity 100 mm

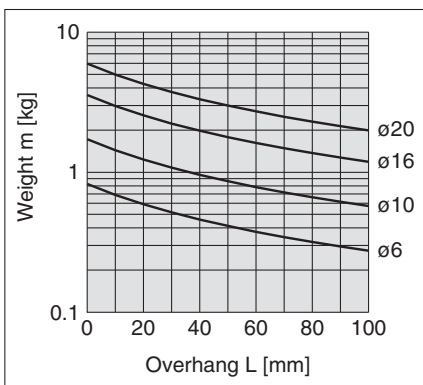

Graph 8 Load Eccentricity 100 mm

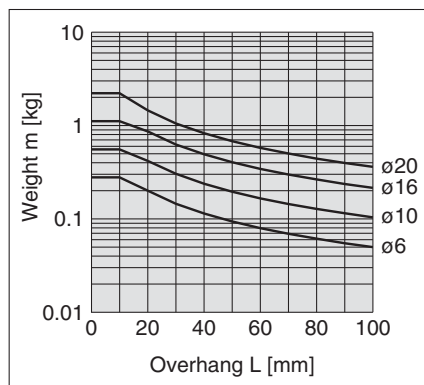

Graph 11 Load Eccentricity 100 mm

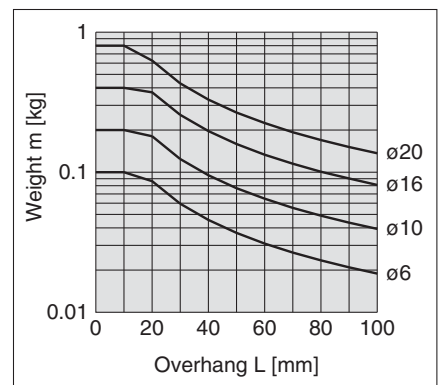

Graph 6 Load Eccentricity 200 mm

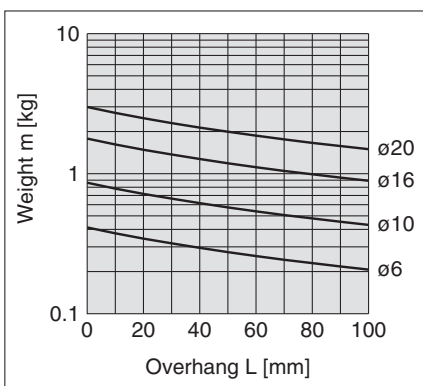

Graph 9 Load Eccentricity 200 mm

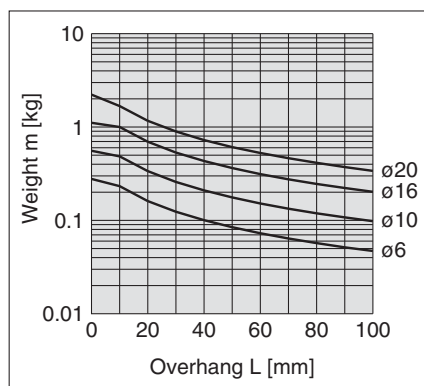

Graph 12 Load Eccentricity 200 mm

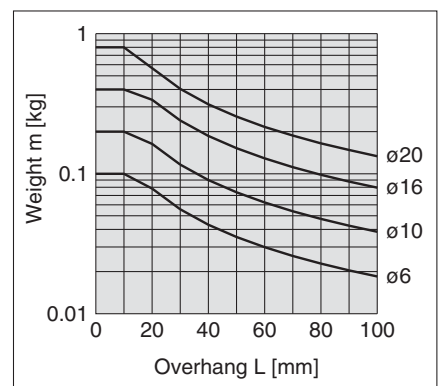

Selection Example (Horizontal Mounting)

2. Selection conditions
- Mounting: Horizontal
 - Maximum speed: 500 mm/s
 - Load eccentricity L_1 : 50 mm
 - Overhang L : 30 mm
 - Load weight m : 0.1 kg

Refer to Graph 10 based on horizontal mounting, a speed of 500 mm/s and load eccentricity L_1 of 50 mm.

In Graph 10, find the intersection of a 30 mm overhang L and load weight m of 0.1 kg, which results in a determination of ø10.

Compact Slide

Series *MXH*

∅6, ∅10, ∅16, ∅20



How to Order

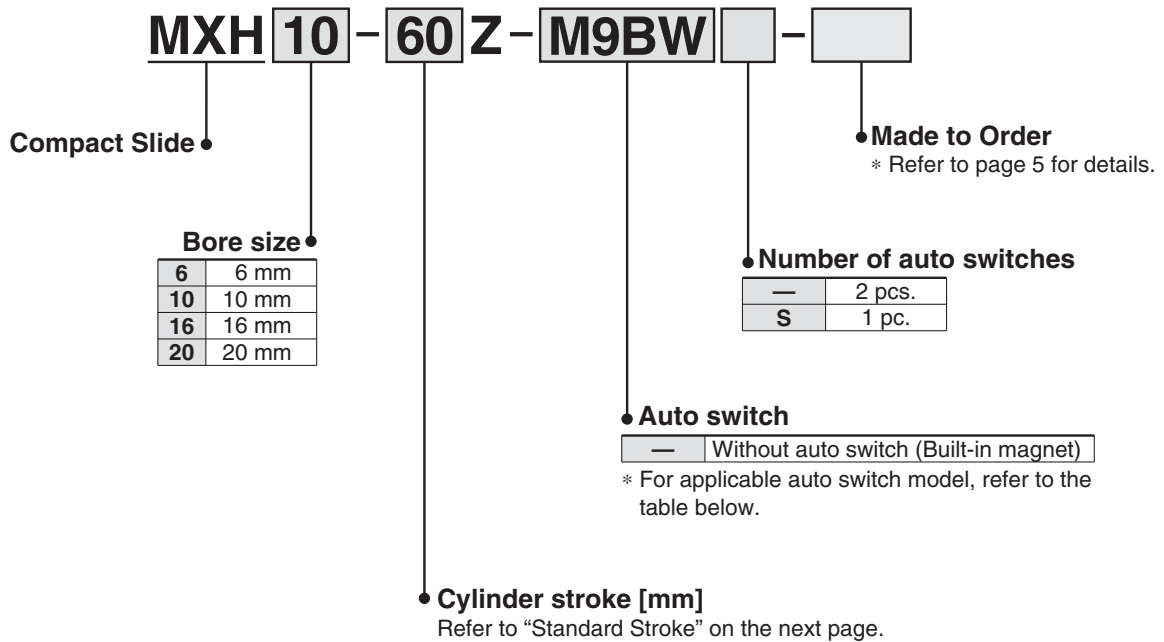

Applicable Auto Switches/Refer to the Auto Switch Guide for further information on auto switches.

Type	Special function	Electrical entry	Indicator light	Wiring (Output)	Load voltage		Auto switch model		Lead wire length [m]				Pre-wired connector	Applicable load			
					DC	AC	Perpendicular	In-line	0.5 (—)	1 (M)	3 (L)	5 (Z)					
Solid state auto switch	—	Grommet	Yes	3-wire (NPN)	24 V	5 V, 12 V	—	M9NV	M9N	●	●	●	○	○	IC circuit	Relay, PLC	
				3-wire (PNP)				M9PV	M9P	●	●	●	○	○			
				2-wire				M9BV	M9B	●	●	●	○	○			
	Diagnostic indication (2-colour indication)			3-wire (NPN)	24 V	5 V, 12 V	—	M9NWV	M9NW	●	●	●	○	○	○		IC circuit
				3-wire (PNP)				M9PWV	M9PW	●	●	●	○	○			
				2-wire				M9BWV	M9BW	●	●	●	○	○			
	Water resistant (2-colour indication)			3-wire (NPN)	24 V	5 V, 12 V	—	M9NAV**	M9NA**	○	○	●	○	○	○		IC circuit
				3-wire (PNP)				M9PAV**	M9PA**	○	○	●	○	○			
				2-wire		12 V		M9BAV**	M9BA**	○	○	●	○	○	—		
Reed auto switch	—	Grommet	Yes	3-wire (NPN equivalent)	24 V	5 V, 12 V	—	A96V	A96	●	—	●	—	—	IC circuit	—	
				2-wire				A93V	A93	●	—	●	●	—	—	—	Relay, PLC
								A90V	A90	●	—	●	—	—	—	—	IC circuit

** Water resistant type auto switches can be mounted on the above models, but in such case SMC cannot guarantee water resistance. Please consult with SMC regarding water resistant type with the above model numbers.

* Lead wire length symbols: 0.5 m — (Example) M9NW * Solid state auto switches marked with "○" are produced upon receipt of order.
 1 m M (Example) M9NWM
 3 m L (Example) M9NWL
 5 m Z (Example) M9NWZ

* Refer to page 13 for applicable auto switches other than listed above.

* For details about auto switches with pre-wired connector, refer to the Auto Switch Guide.

* Auto switches are shipped together, (but not assembled).

Specifications



Symbol
Rubber bumper

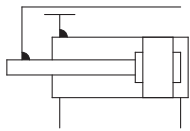

Made to Order
(Refer to pages 16 to 18 for details.)

Symbol	Specifications
-XC79	Machining tapped hole, drilled hole and pin hole additionally
-XB13	Low speed cylinder (5 to 50 mm/s)
-XC3	Special port location
-XC19	Intermediate stroke (Spacer type)
-XC22	Fluororubber seal

Bore size [mm]	6	10	16	20
Fluid	Air			
Action	Double acting			
Piping port size	M5 x 0.8			
Minimum operating pressure	0.15 MPa	0.06 MPa	0.05 MPa	
Maximum operating pressure	0.7 MPa			
Proof pressure	1.05 MPa			
Ambient and fluid temperature	Without auto switch: -10 to 70°C With auto switch: -10 to 60°C (No freezing)			
Piston speed	50 to 500 mm/s			
Allowable kinetic energy [J]	0.0125	0.025	0.05	0.1
Lubrication	Non-lube			
Cushion	Rubber bumper on both ends			
Stroke length tolerance	+1.0 0			
Auto switch (Option)	Solid state auto switch D-M9□, M9□W Reed auto switch D-A9□			

Standard Stroke

Bore size [mm]	Standard stroke [mm]
6, 10, 16, 20	5, 10, 15, 20, 25, 30, 40, 50, 60

Note) Intermediate strokes are available with "Made to Order" model (-XC19).
(For details, refer to page 18.)

Theoretical Output

Bore size [mm]	Rod size [mm]	Operating direction	Piston area [mm ²]	Operating pressure [MPa]		
				0.3	0.5	0.7
6	3	OUT	28	8	14	19
		IN	21	6	10	14
10	4	OUT	78	23	39	55
		IN	66	19	33	46
16	6	OUT	201	60	101	141
		IN	172	51	86	121
20	8	OUT	314	94	157	220
		IN	264	79	132	185

Weight

Model	Stroke [mm]								
	5	10	15	20	25	30	40	50	60
MXH6	61	66	75	80	88	93	107	120	134
MXH10	104	112	125	133	146	153	174	195	216
MXH16	194	204	222	232	250	260	288	316	343
MXH20	352	369	400	417	448	466	514	562	610

Table Displacement

Table Displacement due to Pitch Moment (Reference)

Table displacement (arrow) when a load acts upon the section marked with the arrow at the full stroke of the Compact Slide

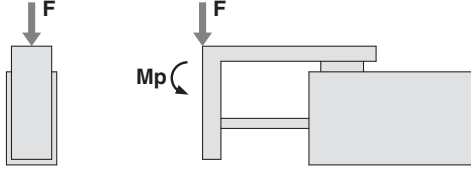

MXH6

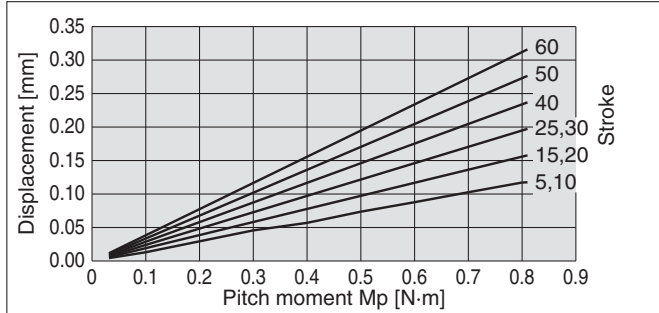

MXH10

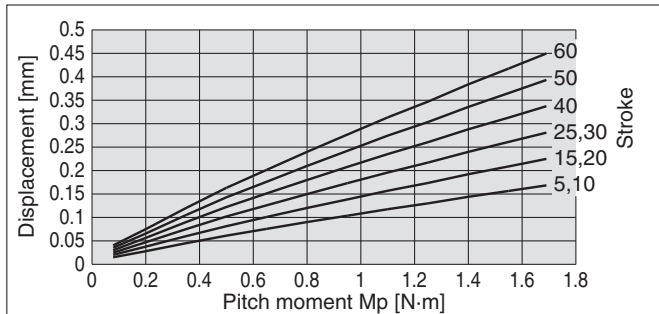

MXH16

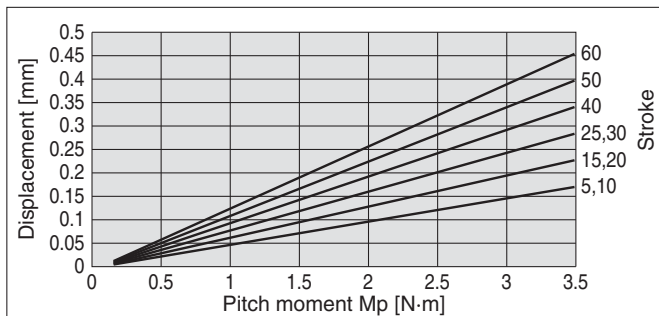

MXH20

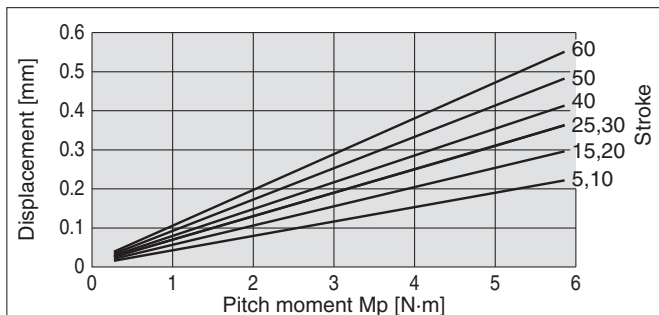
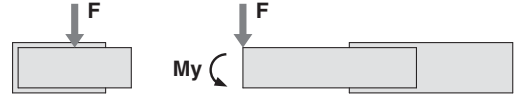
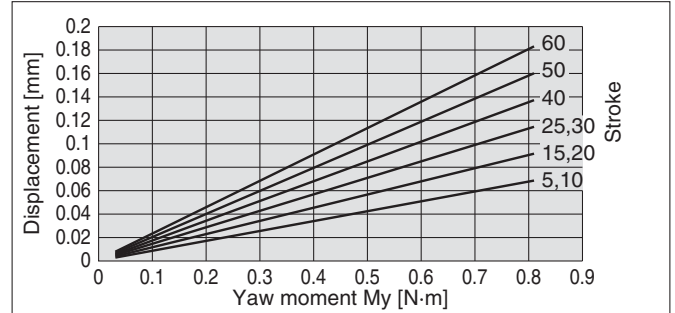

Table Displacement due to Yaw Moment (Reference)

Table displacement (arrow) when a load acts upon the section marked with the arrow at the full stroke of the Compact Slide



MXH6



MXH10

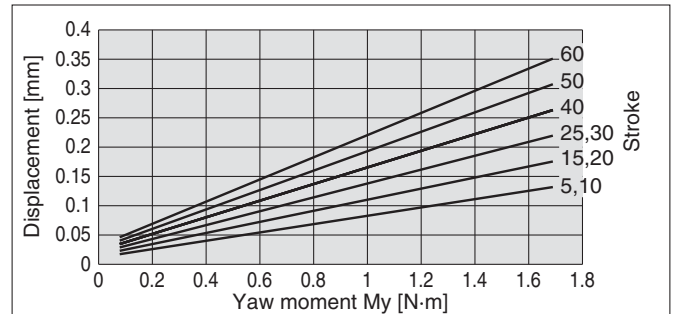

MXH16

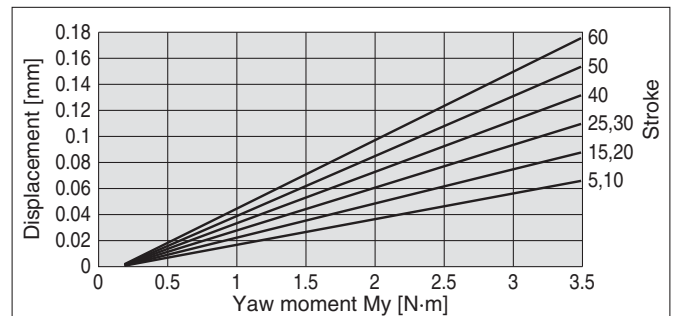

MXH20

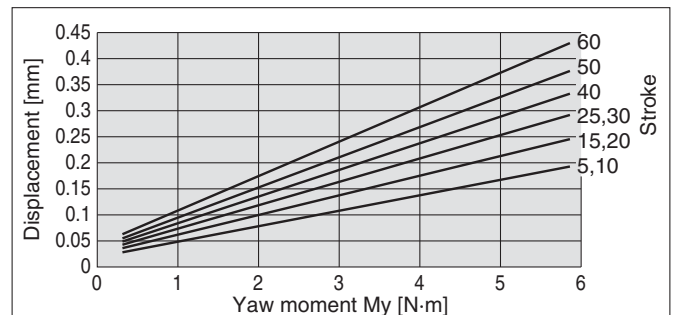

⚠ Caution Design

1. Selection of a bore size cannot be made only with above graphs. Select a bore size in accordance with "Model Selection" on page 2 and 3.
2. Displacement may increase after an impact load has been applied. When the table is subjected to an impact load, there may be permanent distortion of the guide unit and increased displacement.

Series MXH

Table Displacement

Table Displacement due to Roll Moment (Reference)

Table displacement (at A) when a load acts upon section F at the full stroke of the Compact Slide

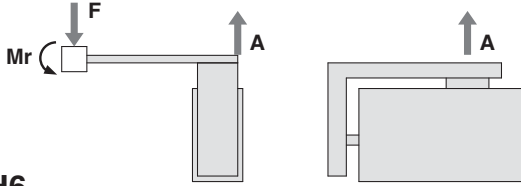

MXH6

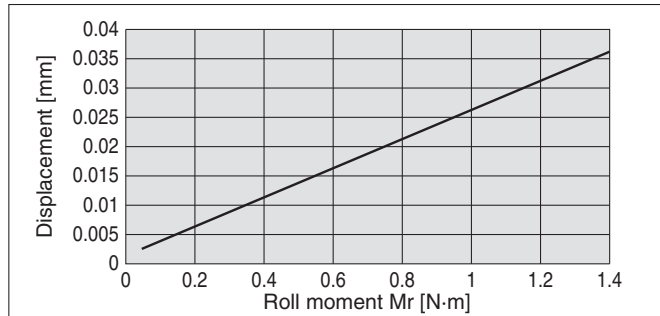

MXH10

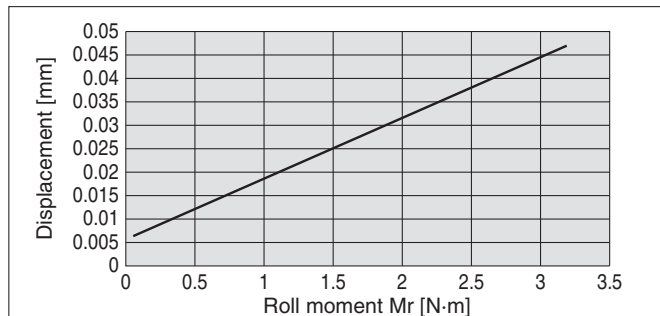

MXH16

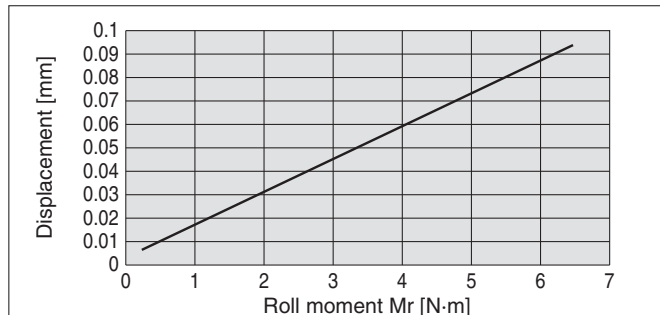

MXH20

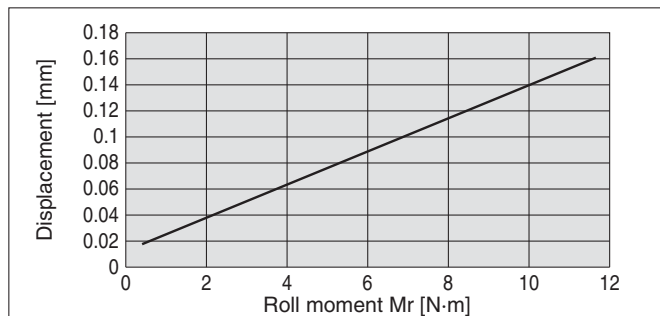

Table Accuracy

Traveling parallelism	Stroke [mm]	
	5 to 30	40 to 60
	0.05 mm or less	0.1 mm or less

* Values when no load and no pressure applied.

Allowable Moment

Model	Allowable moment [N·m]		
	Pitch moment	Yaw moment	Roll moment
	M_p	M_y	M_r
MXH6	0.81	0.81	1.40
MXH10	1.69	1.69	3.19
MXH16	3.49	3.49	6.47
MXH20	5.86	5.86	11.66

Design

⚠ Caution

Selection of a bore size cannot be made only with above allowable moment. Select a bore size in accordance with "Model Selection" on pages 2 and 3.

Construction

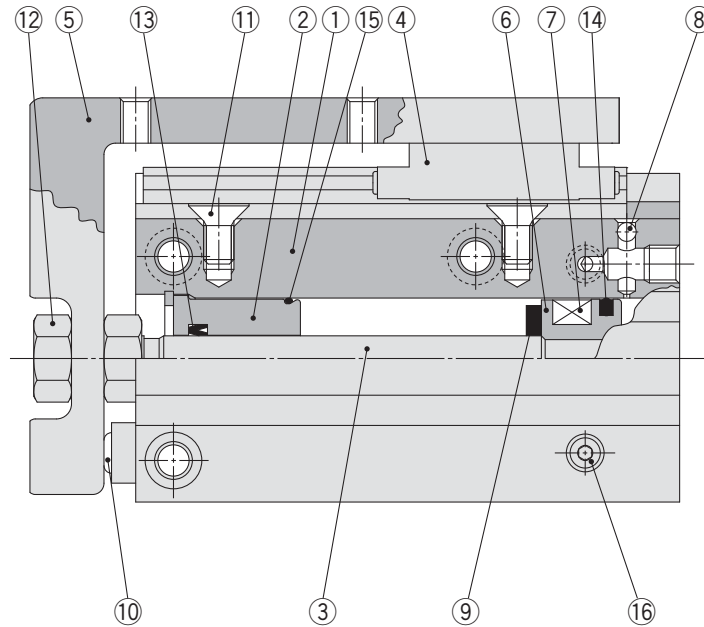

Component Parts

No.	Description	Material	Note
1	Cylinder tube	Aluminium alloy	Hard anodised
2	Rod cover	Aluminium alloy	Hard anodised
3	Piston rod	Stainless steel	
4	Guide	The main parts are made of stainless steel.	
5	Table	Aluminium alloy	Hard anodised
6	Piston	Aluminium alloy	Chromated
7	Magnet	Magnetic material	
8	Steel ball	Carbon steel	
9	Bumper	Urethane	
10	Bumper	Urethane	
11	Countersunk head screw	Carbon steel	Nickel plating
12	Nut	Brass	Nickel plating
13	Rod seal	NBR	
14	Piston seal	NBR	
15	Gasket	NBR	
16	Plug	Carbon steel	Zinc chromated

Note) The MXH series cannot be disassembled.

Series MXH

Dimensions: $\varnothing 6$

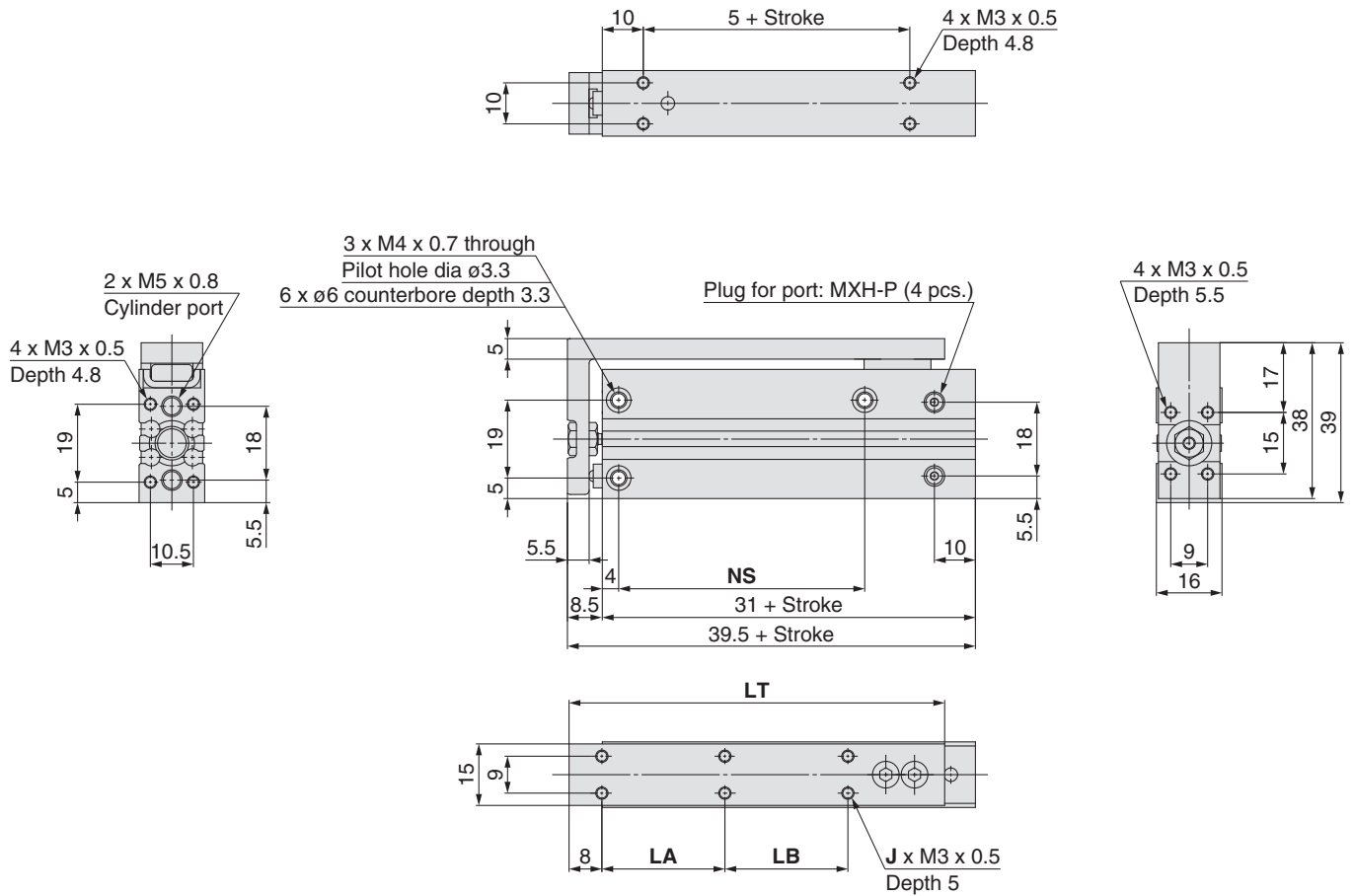

Note 1) Refer to "Specific Product Precautions" for mounting of the Compact Slide and a workpiece.
 Note 2) When changing the port location, please order a new port plug: MXH-P (2 pcs.)

Stroke [mm]	J	LA	LB	LT	NS
5	4	10	—	42	14
10	4	10	—	42	14
15	4	20	—	52	24
20	4	20	—	52	24
25	4	30	—	62	30
30	4	30	—	62	30
40	6	20	20	72	45
50	6	25	25	82	55
60	6	30	30	92	60

Dimensions: $\varnothing 10$

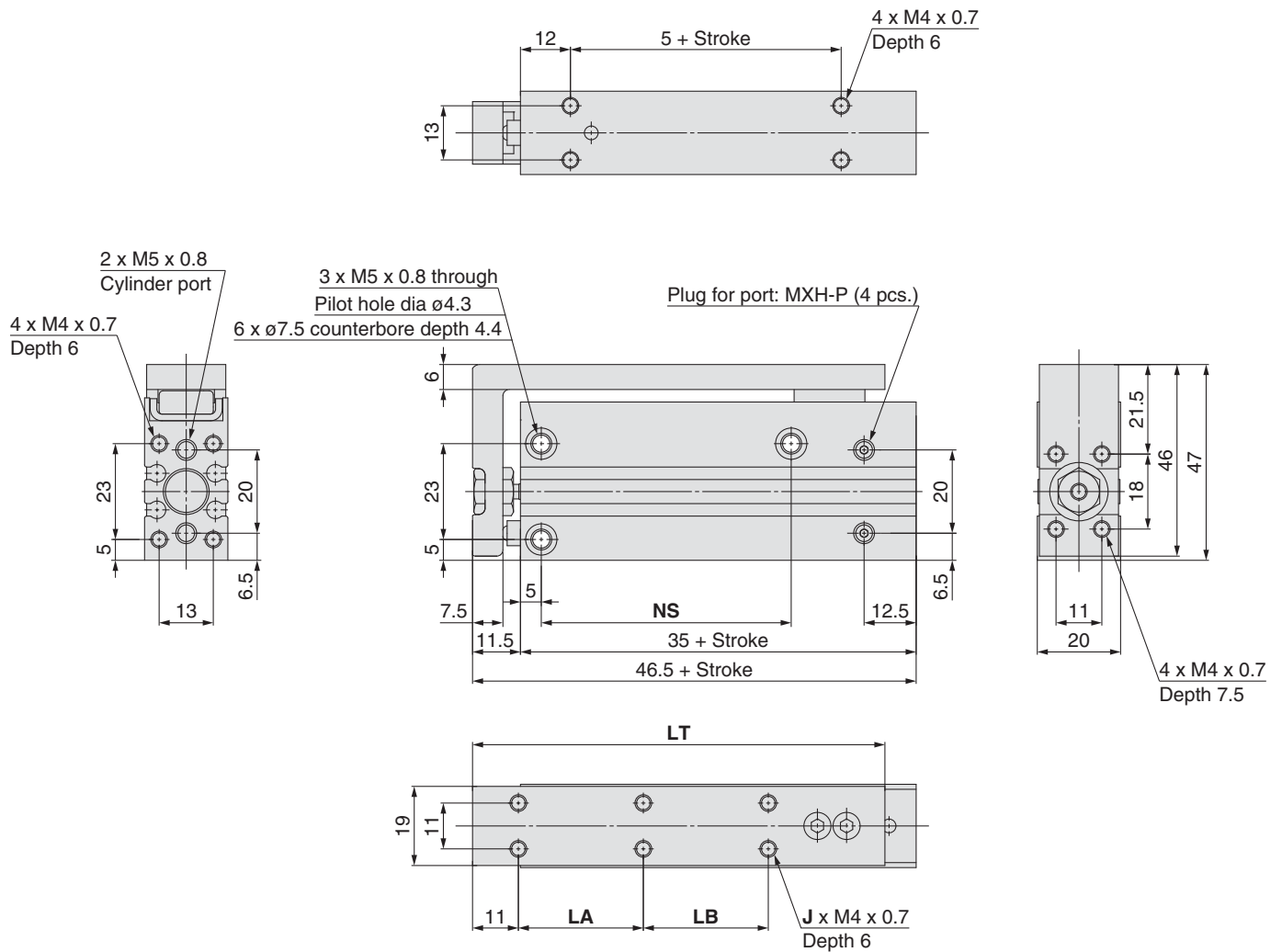

Note 1) Refer to "Specific Product Precautions" for mounting of the Compact Slide and a workpiece.
 Note 2) When changing the port location, please order a new port plug: MXH-P (2 pcs.)

Stroke [mm]	J	LA	LB	LT	NS
5	4	10	—	49	14
10	4	10	—	49	14
15	4	20	—	59	24
20	4	20	—	59	24
25	4	30	—	69	30
30	4	30	—	69	30
40	6	20	20	79	45
50	6	25	25	89	55
60	6	30	30	99	60

Series MXH

Dimensions: $\varnothing 16$

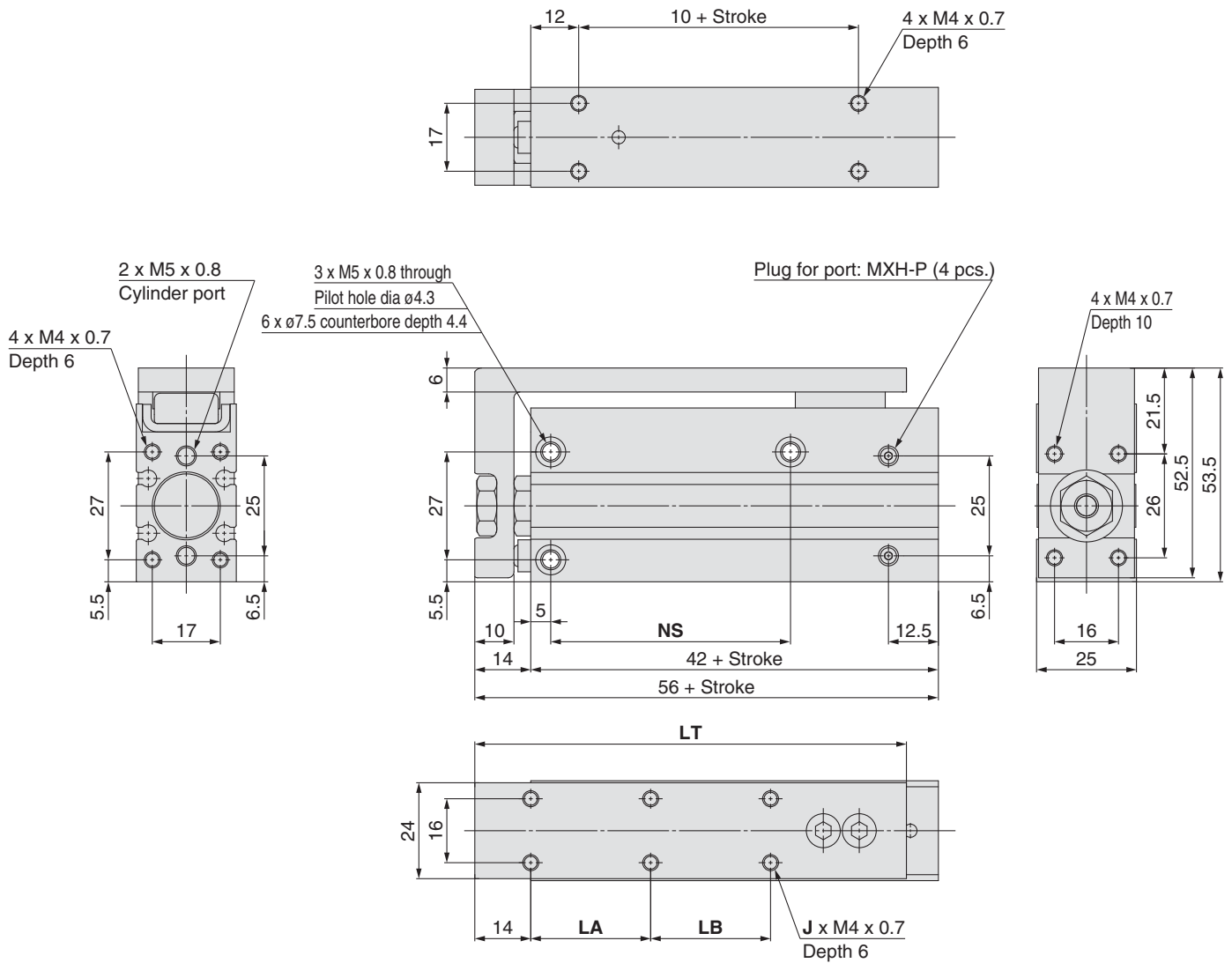

Note 1) Refer to "Specific Product Precautions" for mounting of the Compact Slide and a workpiece.
 Note 2) When changing the port location, please order a new port plug: MXH-P (2 pcs.)

Stroke [mm]	J	LA	LB	LT	NS
5	4	10	—	58	20
10	4	10	—	58	20
15	4	20	—	68	30
20	4	20	—	68	30
25	4	30	—	78	40
30	4	30	—	78	40
40	6	20	20	88	50
50	6	25	25	98	60
60	6	30	30	108	60

Dimensions: $\varnothing 20$

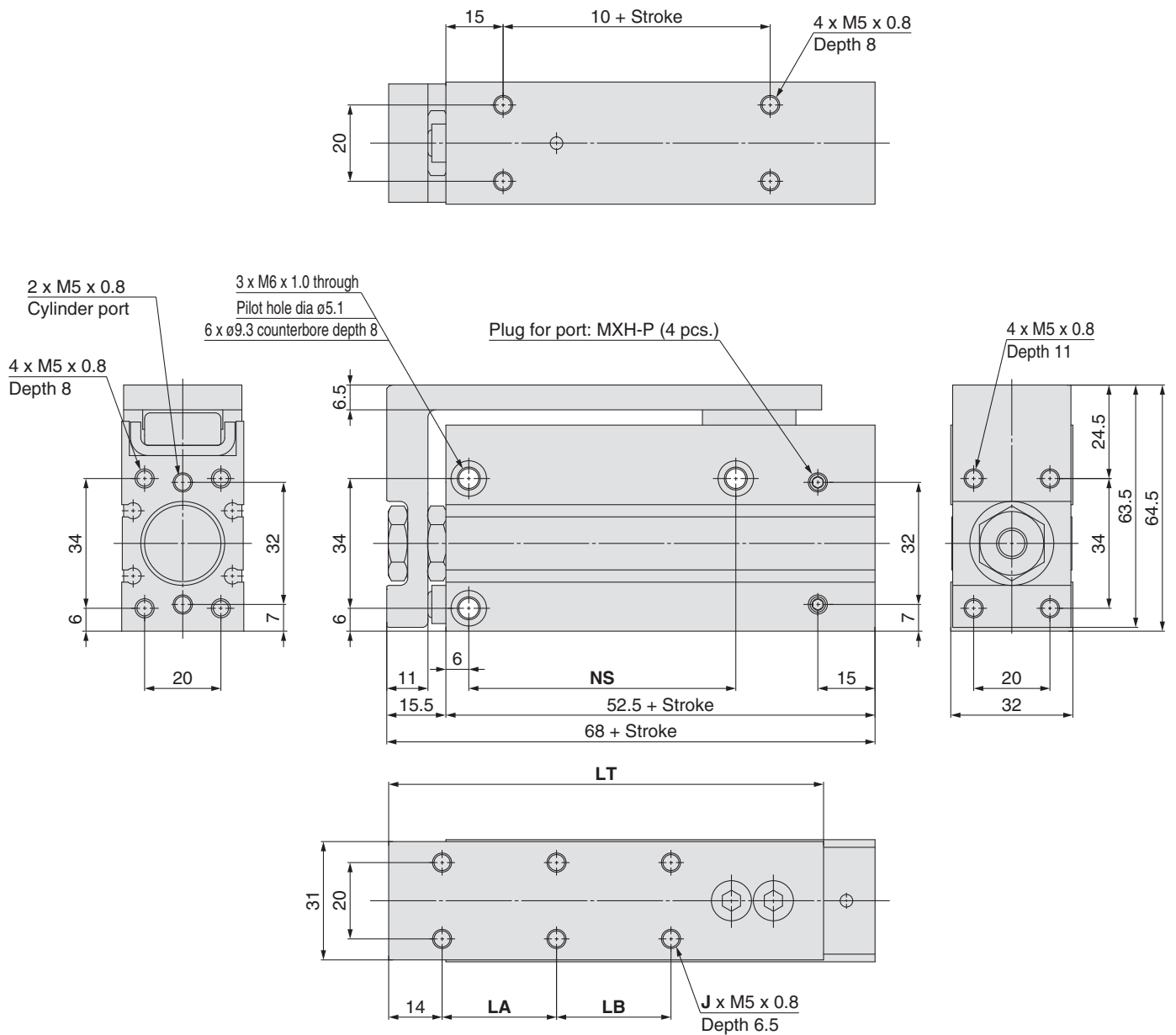

Note 1) Refer to "Specific Product Precautions" for mounting of the Compact Slide and a workpiece.
 Note 2) When changing the port location, please order a new port plug: MXH-P (2 pcs.)

Stroke [mm]	J	LA	LB	LT	NS
5	4	10	—	64	20
10	4	10	—	64	20
15	4	20	—	74	25
20	4	20	—	74	25
25	4	30	—	84	40
30	4	30	—	84	40
40	6	20	20	94	50
50	6	25	25	104	70
60	6	30	30	114	70

Series MXH Auto Switch Mounting

Minimum Stroke for Auto Switch Mounting

Number of auto switches mounted	Applicable auto switch model		
	D-M9□, M9□V	D-M9□W, M9□WV D-M9□A, M9□AV	D-A9□, A9□V
1 pc.	5	5	5
2 pcs.	5	10	10

Auto Switch Proper Mounting Position (Detection at Stroke End) and Its Mounting Height

D-M9□
D-M9□W
D-M9□A
D-A9□

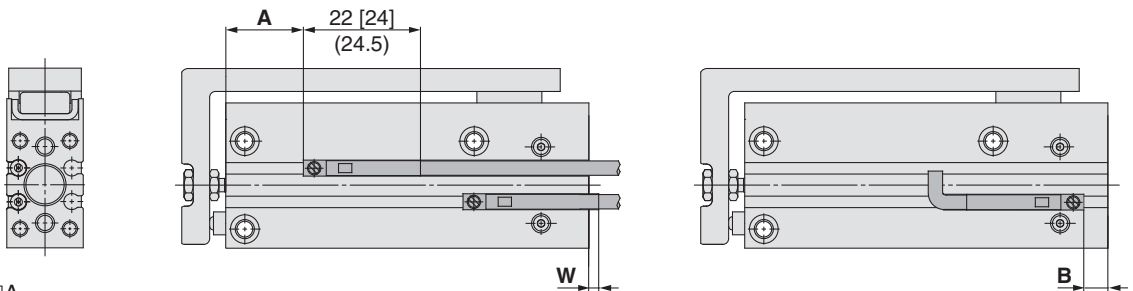

[]: Value of the D-M9□A
(): Value of the D-A90/A93

D-M9□V
D-M9□WV
D-M9□AV
D-A9□V

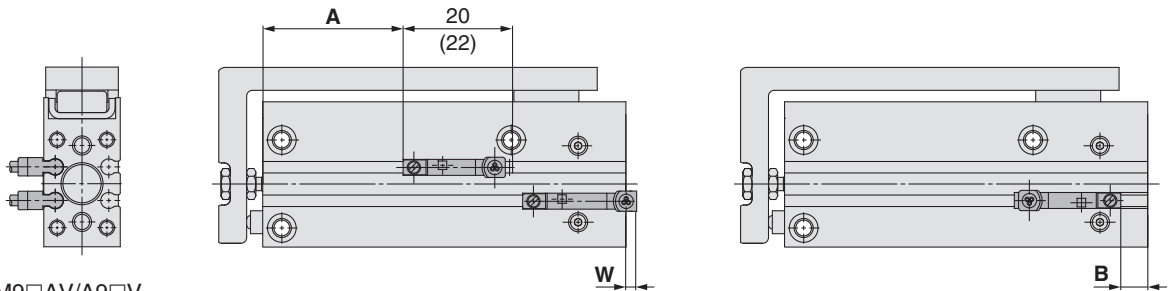

(): Value of the D-M9□AV/A9□V

Bore size [mm]	D-M9□W, D-M9□			D-M9□WV, D-M9□V			D-M9□A			D-M9□AV			D-A9□, D-A9□V		
	A	W	B	A	W	B	A	W	B	A	W	B	A	W	B
6	16.5	7.5	2.5	16.5	5.5	2.5	16.5	9.5	2.5	16.5	7.5	2.5	12.5	3.5 (6)	—
10	15.0	2.0	7.5	15.0	0	7.5	15.0	4.0	7.5	15.0	2.0	7.5	11.0	-2.0 (0.5)	3.5
16	22.0	2.0	8.0	22.0	0	8.0	22.0	4.0	8.0	22.0	2.0	8.0	18.0	-2.0 (0.5)	4.0
20	30.0	-0.5	10.5	30.0	-2.5	10.5	30.0	1.5	10.5	30.0	-0.5	10.5	26.0	-4.5 (-2)	6.5

Note 1) Negative figures in the table W indicate that an auto switch is mounted inward from the edge of the cylinder body.

Note 2) In the case of models with 5 and 10 strokes, the auto switch may not turn off due to operating range or two auto switches may turn on simultaneously. Fix auto switches outside 1 to 4 mm further than the values in the table above. (If one auto switch is used, make sure that it turns ON and OFF properly; If two auto switches are used, make sure that both auto switches turn ON.)

Note 3) () in column W denotes the D-A90/A93 dimensions.

Operating Range

Auto switch model	Bore size			
	6	10	16	20
D-M9□, M9□V D-M9□W, M9□WV D-M9□A, M9□AV	3	3.5	5	6
D-A9□, A9□V	5	6	9	11

* Values which include hysteresis are for guideline purposes only, they are not a guarantee (assuming approximately ±30% dispersion) and may change substantially depending on the ambient environment.

Other than the applicable auto switches listed in "How to Order", the following auto switches can be mounted.
* Normally closed (NC = b contact) solid state auto switches (D-F9G/F9H) are also available. Refer to the Auto Switch Guide.

Auto Switch Mounting

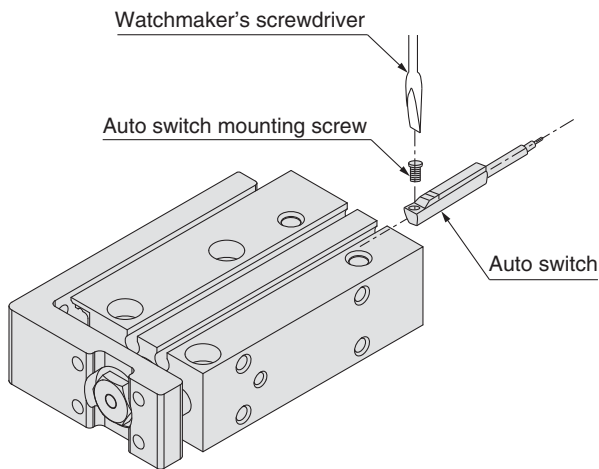

- When tightening the auto switch mounting screw, use a watchmaker's screwdriver with a handle 5 to 6 mm in diameter.

Tightening Torque of Auto Switch Mounting Screw [N·m]

Auto switch model	Tightening torque
D-A9□(V)	0.10 to 0.20
D-M9□(V) D-M9□W(V) D-M9□A(V)	0.05 to 0.15

Note) When used with side ported type, it is not possible to mount the D-A9□V/M9□V type on the side to which the piping is connected.

Prior to Use

Auto Switch Connection and Example

Sink Input Specifications

3-wire, NPN

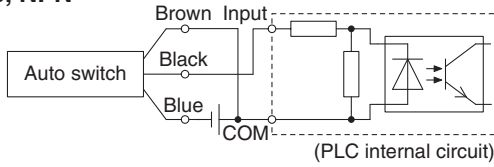

2-wire

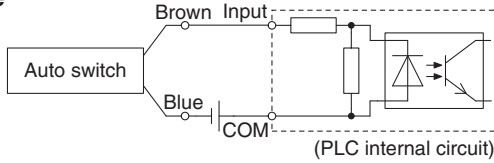

Source Input Specifications

3-wire, PNP

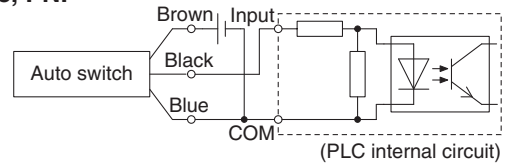

2-wire

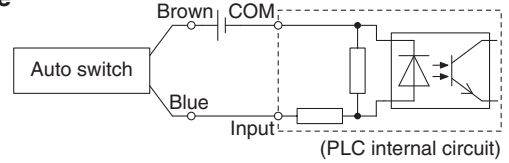

Connect according to the applicable PLC input specifications, as the connection method will vary depending on the PLC input specifications.

Example of AND (Series) and OR (Parallel) Connection

* When using solid state auto switches, ensure the application is setup so the signals for the first 50 ms are invalid.

3-wire AND connection for NPN output (Using relays)

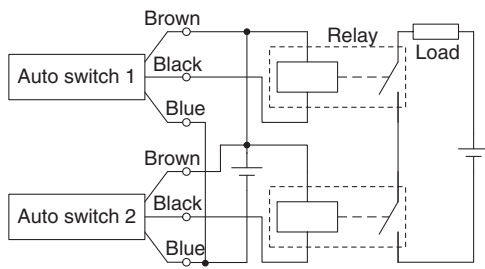

(Performed with auto switches only)

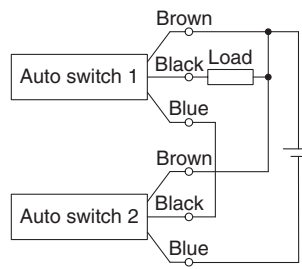

3-wire OR connection for NPN output

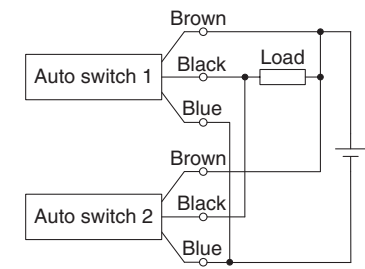

3-wire AND connection for PNP output (Using relays)

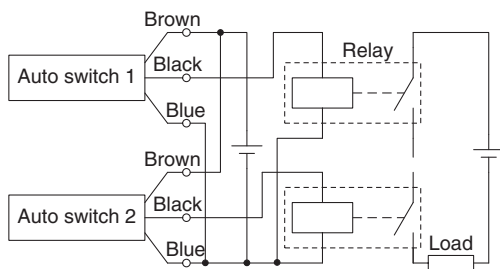

(Performed with auto switches only)

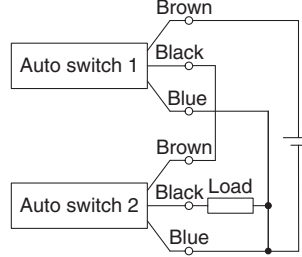

3-wire OR connection for PNP output

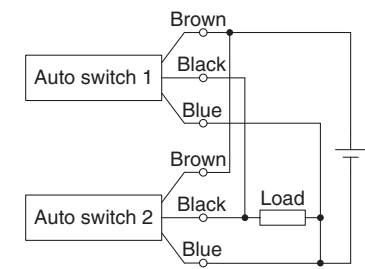

2-wire AND connection

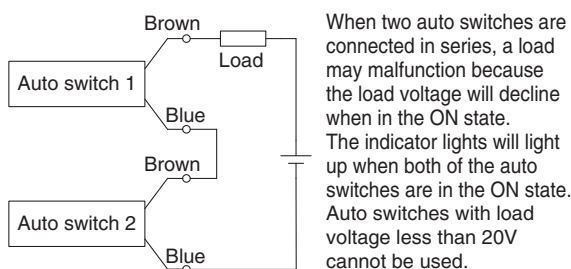

$$\begin{aligned} \text{Load voltage at ON} &= \text{Power supply voltage} - \\ &= \text{Residual voltage} \times 2 \text{ pcs.} \\ &= 24 \text{ V} - 4 \text{ V} \times 2 \text{ pcs.} \\ &= 16 \text{ V} \end{aligned}$$

Example: Power supply is 24 VDC
Internal voltage drop in auto switch is 4 V.

2-wire OR connection

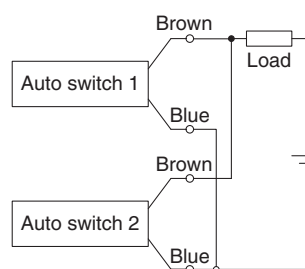

$$\begin{aligned} \text{Load voltage at OFF} &= \text{Leakage current} \times 2 \text{ pcs.} \times \\ &= \text{Load impedance} \\ &= 1 \text{ mA} \times 2 \text{ pcs.} \times 3 \text{ k}\Omega \\ &= 6 \text{ V} \end{aligned}$$

Example: Load impedance is 3 kΩ.
Leakage current from auto switch is 1 mA.

(Solid state)
When two auto switches are connected in parallel, malfunction may occur because the load voltage will increase when in the OFF state.

(Reed)
Because there is no current leakage, the load voltage will not increase when turned OFF. However, depending on the number of auto switches in the ON state, the indicator lights may sometimes grow dim or not light up, due to the dispersion and reduction of the current flowing to the auto switches.

Series MXH Simple Specials

These changes are dealt with Simple Specials System.

Symbol
-XC79

1 Machining tapped hole, drilled hole and pin hole additionally

This simple special is meant for machining additionally tapped hole, drilled hole and pin hole, as requested from users, on parts designed largely for mounting a workpiece etc., in the combined air cylinders. Note that there are some areas where additional machining is not allowed, so please refer to the additional machining restriction section below.

Applicable Series and Component Parts Applicable for Additional Machining

Series	Model	Type	Component parts applicable for additional machining
MXH	Compact Slide	MXH	Standard type
			Table

Precautions

- We cannot take any responsibility as for the intensity of holes machined additionally and the effects of decreased intensity for the product itself.
- Areas where additional machining was done will not be plated again.
- Be sure to fill in "through" for through-hole, and "effective depth" for blind hole.
- When using by machining through-hole additionally, ensure that the tip of the bolt etc., for mounting a workpiece should not stick into the cylinder side. It may result in an unexpected problem.
- Use caution not to interfere the existing mounting hole on the standard products with the hole to be machined additionally. But it is possible to drill additionally the larger size of hole at the same position as the existing hole.

Supplementary Explanation/Holes which can be additionally machined are the following 3 types.

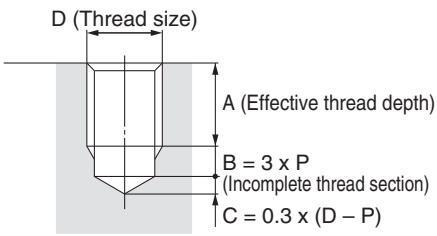
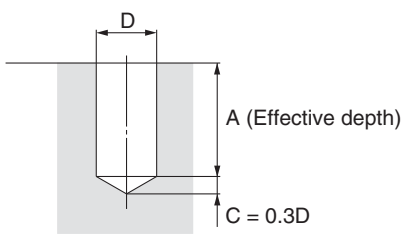
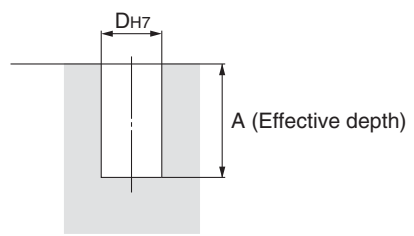
Tapped hole	Drilled hole	Pin hole												
<p>Designated nominal diameter and tapped hole of a pitch are machined additionally. (Maximum nominal thread diameter M20) Blind hole is deep into the bottom of prepared hole which sums up A to C in the figure below in contrast to the effective depth of tapped hole. When there is a condition which does not allow through-hole etc., leave sufficient thickness in the inner part of hole.</p>  <p>Note) P stands for thread pitch.</p>	<p>Drilled hole of a designated internal diameter is machined. (Maximum hole diameter 20 mm) If you wish for blind hole, instruct us with effective depth. (Refer to the figure below.) Besides, dimensional accuracy for internal diameter will be ± 0.2 mm.</p> 	<p>Pin hole of a designated diameter (reamer hole) is machined. (Maximum hole diameter 20 mm) Internal dimension tolerates H7 tolerance to the designated hole diameter. (Refer to the table below.)</p> <table border="1" data-bbox="1029 1310 1484 1377"> <thead> <tr> <th>Hole dia.</th> <th>3 or less</th> <th>Over 3 to 6</th> <th>Over 6 to 10</th> <th>Over 10 to 18</th> <th>Over 18 to 20</th> </tr> </thead> <tbody> <tr> <td>Tolerance</td> <td>+0.01 0</td> <td>+0.012 0</td> <td>+0.015 0</td> <td>+0.018 0</td> <td>+0.021 0</td> </tr> </tbody> </table> 	Hole dia.	3 or less	Over 3 to 6	Over 6 to 10	Over 10 to 18	Over 18 to 20	Tolerance	+0.01 0	+0.012 0	+0.015 0	+0.018 0	+0.021 0
Hole dia.	3 or less	Over 3 to 6	Over 6 to 10	Over 10 to 18	Over 18 to 20									
Tolerance	+0.01 0	+0.012 0	+0.015 0	+0.018 0	+0.021 0									

Additional Machining Restriction/Since the slant lines denote the additional machining restriction section, design the dimensions, referring to below.

Table material: Aluminium		Dimensions of areas where additional machining is not allowed [mm]				
Model	D1	D2	LY	LX	LZ	
MXH6	11	5.8	9	20	5.5	
MXH10	14	6	11	22	6.5	
MXH16	18	7.5	16	29	6.5	
MXH20	22	9.7	22	32	7	

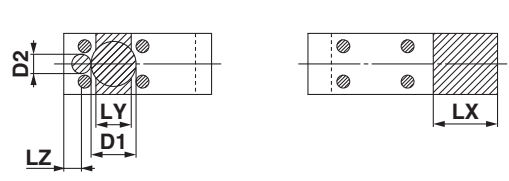

Series MXH Made to Order

Please contact SMC for detailed dimensions, specifications and lead times.



1 Low speed cylinder (5 to 50 mm/s)

Symbol
-XB13

Even if driving at lower speeds 5 to 50 mm/s, there would be no stick-slip phenomenon and it can run smoothly.

How to Order

MXH Standard model no. - XB13
↓
 Low speed cylinder

Note 1) Operate without lubrication from a pneumatic system lubricator.

Note 2) For speed adjustment, use speed controllers for controlling at lower speeds. (Series AS-FM/AS-M)

Specifications

Piston speed	5 to 50 mm/s
Additional specifications	Same as standard type
Dimensions	Same as standard type

Warning

Operating Precautions

Be aware that smoking cigarettes etc., after your hands have come into contact with the grease used in this cylinder can create a gas that is hazardous to humans.

2 Special port location

Symbol
-XC3

Change to the standard port location

How to Order

MXH Standard model no. - XC3□
↓
 Change of port location

Specifications: Same as standard type

The port location of a standard product is in the axial direction, and it is shipped as plugged on both sides. However, side ported type can be ordered. A shifting of plugs should not be done.

Relationship between Port Location and Plug Position

Standard	-XC3A	-XC3B

3 Intermediate stroke (Spacer type)

Symbol
-XC19

Dealing with the intermediate stroke by installing a spacer with the standard stroke cylinder

How to Order

MXH Standard model no. - XC19
Intermediate stroke (Spacer type) ●

Applicable Stroke [mm]

ø6, ø10, ø16, ø20	35, 45, 55
-------------------	------------

- Dealing with it by installing a 5 mm width spacer with the standard stroke cylinder
- Please contact SMC when stroke other than applicable stroke is required.

Specifications: Same as standard type

Dimensions: External dimensions are the same as standard stroke products added by 5 mm for the required stroke.

4 Fluororubber seal

Symbol
-XC22

How to Order

MXH Standard model no. - XC22
Fluororubber seal ●

Note 1) Please contact SMC, as the type of chemical and the operating temperature may not allow the use of this product.

Note 2) Cylinders with auto switches can also be produced; however, auto switch related parts (auto switch units, mounting brackets, built-in magnets) are the same as standard products.

Before using these, please contact SMC regarding their suitability for the operating environment.

Specifications

Seal material	Fluororubber
Ambient temperature range	Note) With auto switch: -10°C to 60°C (No freezing) Without auto switch: -10°C to 70°C
Additional specifications	Same as standard type
Dimensions	Same as standard type



Series MXH

Specific Product Precautions 1

Be sure to read this before handling. Refer to the back cover for Safety Instructions, "Handling Precautions for SMC Products" and the Operation Manual for Actuator and Auto Switch Precautions. <http://www.smcworld.com>

Auto Switch Mounting

When installing in close proximity to each other

Caution

1. When the Compact Slide with the D-A9□ or D-M9□ auto switch is used, the auto switches could activate unintentionally if the installed distance is less than the dimension shown in Table (1). Therefore, make sure to provide at least this much clearance. Due to unavoidable circumstances, if they must be used with less distance than the dimensions given in the table below, the cylinders must be shielded. Therefore, affix a steel plate or a magnetic shielding plate (MU-S025) to the area on the cylinder that corresponds to the adjacent auto switch. (Please contact SMC for details.) The auto switch could activate unintentionally if a shielding plate is not used.

Bore size [mm]	d [mm]	L [mm]
MXH6	5	21
MXH10	5	25
MXH16	10	35
MXH20	15	47

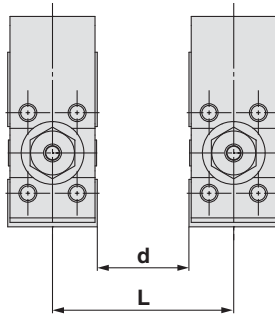

Dimensions of a shielding plate (MU-S025) that is sold separately are indicated as reference.

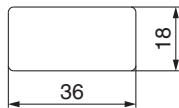

Material: Ferrite stainless steel, Thickness: 0.3 mm
Since the back side is treated with adhesive, it is possible to attach to the cylinder.

Operating Precautions

Warning

Be aware that smoking cigarettes etc., after your hands have come into contact with the grease used in this cylinder can create a gas that is hazardous to humans.

Caution

1. Do not place your fingers in the clearance between the non-rotating plate and the cylinder tube. Your fingers could get caught between the table and the cylinder tube when the piston rod retracts. If fingers are caught in a cylinder, there is a danger of injury due to the strong cylinder output, and therefore, caution must be exercised.
2. In terms of the work load and moment, operate the cylinder below the maximum work load and allowable moment.
3. If the output of the Compact Slide is applied directly to the table, make sure it is applied along the rod axial line. (Refer to the figure below.)

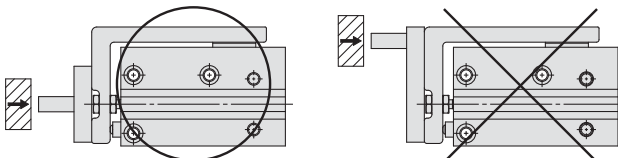

Operating Precautions

4. Make sure to connect a speed controller and adjust it to a speed of 500 mm/s or less to operate the cylinder.
5. If the vibration of the workpiece due to cylinder operation is clearly noticeable, recheck the operating conditions. Even when the moment applied to the product is under the allowable moment, the vibration width may be increased if a large amount of eccentric load is applied.

Operating Direction with Different Pressure Ports

Caution

1. The Compact Slide can be piped in 3 directions. Check the pressure port and the operating direction. (Refer to the figure below.) Change the plug location depending on the application. Confirm that there is no air leakage after changing the plug location. If there is slight leakage, remove the plug, check the seat surface and reassemble.

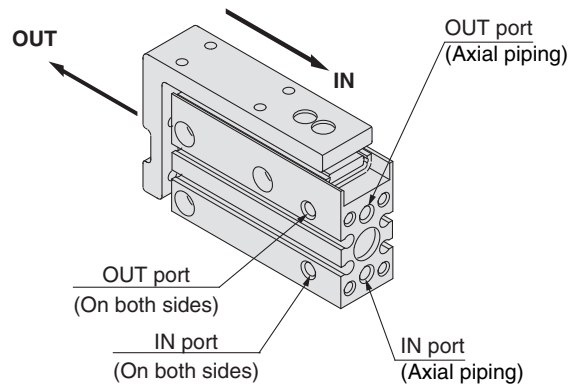

When changing the port location, please order the following plug. Replacement port plug part number: MXH-P (2 pcs.)

2. If the plug is tightened excessively when attaching it to the axial piping of MXH6, it may be in contact with the internal steel ball, causing air leakage. As for the plug tightening guide, make the adjustment so that the plug sunk dimension from the cylinder tube surface is 0 to less than 1 mm.

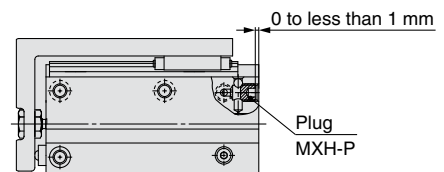

Backlash in the Stroke Direction

Caution

- Since the connection between the piston rod and table is a floating mechanism, the table has backlash of 0.15 mm or less in the stroke direction. (Refer to the figure on the right.)

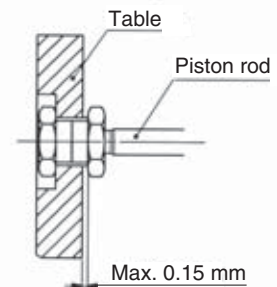

Connecting part of piston rod and table



Series MXH

Specific Product Precautions 2

Be sure to read this before handling. Refer to the back cover for Safety Instructions, "Handling Precautions for SMC Products" and the Operation Manual for Actuator and Auto Switch Precautions. <http://www.smcworld.com>

Mounting

Caution

1. When tightening threads for the Compact Slide, properly tighten within the specified torque.

How to Mount the Compact Slide

The Compact Slide can be mounted in 4 directions. Make a selection suitable for the applicable machinery and work pieces, etc.

Lateral Mounting (Body through-hole)

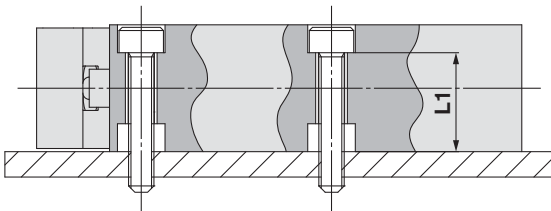

Model	Bolt	Maximum tightening torque [N·m]	L1
MXH6	M3 x 0.5	1.1	12.7
MXH10	M4 x 0.7	2.5	15.6
MXH16	M4 x 0.7	2.5	20.6
MXH20	M5 x 0.8	5.1	24.0

Lateral Mounting (Body thread)

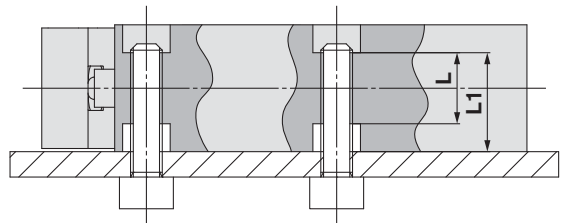

Model	Bolt	Maximum tightening torque [N·m]	L1	L
MXH6	M4 x 0.7	2.5	12.7	9.4
MXH10	M5 x 0.8	5.1	15.6	11.2
MXH16	M5 x 0.8	5.1	20.6	16.2
MXH20	M6 x 1	8.1	24.0	16.0

Vertical Mounting (Body thread)

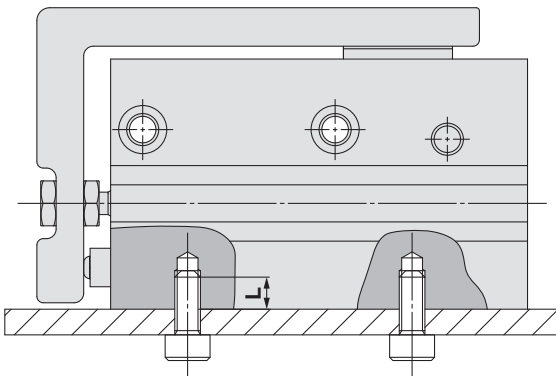

Model	Bolt	Maximum tightening torque [N·m]	L
MXH6	M3 x 0.5	1.1	4.8
MXH10	M4 x 0.7	2.5	6
MXH16	M4 x 0.7	2.5	6
MXH20	M5 x 0.8	5.1	8

Axial Mounting (Body thread)

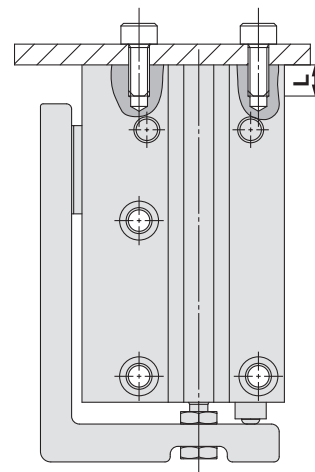

Model	Bolt	Maximum tightening torque [N·m]	L
MXH6	M3 x 0.5	1.1	4.8
MXH10	M4 x 0.7	2.5	6
MXH16	M4 x 0.7	2.5	6
MXH20	M5 x 0.8	5.1	8



Series MXH

Specific Product Precautions 3

Be sure to read this before handling. Refer to the back cover for Safety Instructions, "Handling Precautions for SMC Products" and the Operation Manual for Actuator and Auto Switch Precautions. <http://www.smcworld.com>

Mounting

Caution

1. When tightening threads for the Compact Slide, properly tighten within the specified torque.
2. When mounting a workpiece on the top of the table, do not screw a bolt in more deeper than the below table L dimension.
If screwing a bolt in more deeper than the L dimension, the edge of the bolt could reach the linear guide and might damage the linear guide.

How to Mount a Workpiece

Work pieces can be mounted on 2 surfaces of the Compact Slide.

Front Mounting

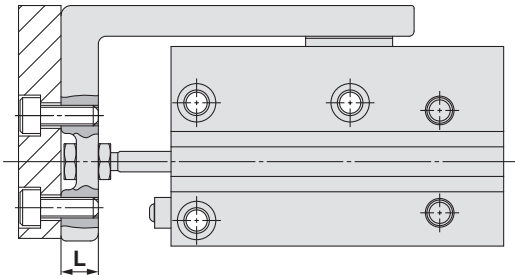

Model	Bolt	Maximum tightening torque [N·m]	L
MXH6	M3 x 0.5	1.1	5.5
MXH10	M4 x 0.7	2.5	7.5
MXH16	M4 x 0.7	2.5	10
MXH20	M5 x 0.8	5.1	11

Top Mounting

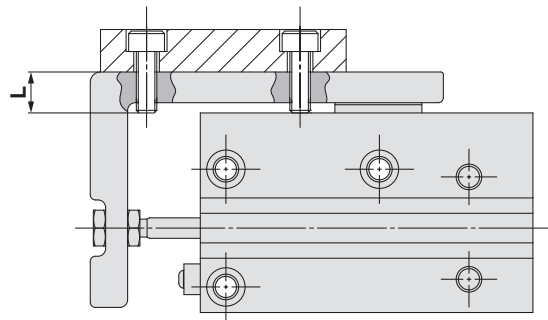

Model	Bolt	Maximum tightening torque [N·m]	L
MXH6	M3 x 0.5	1.1	6.5
MXH10	M4 x 0.7	2.5	8
MXH16	M4 x 0.7	2.5	9
MXH20	M5 x 0.8	5.1	9.5

How to Mount a Workpiece

Work pieces can be mounted on 2 surfaces of the Compact Slide.

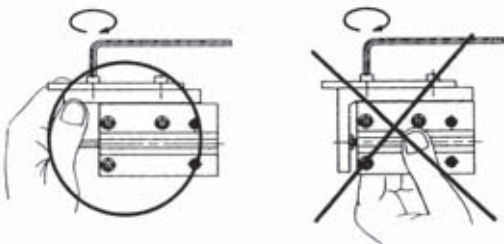

- Since the table is supported by the linear guide, take care not to apply strong impact or large moment, etc., when mounting work pieces.
- Hold the table when fastening work pieces to it with bolts etc. If the body is held while tightening bolts etc., the guide section will be subjected to a large moment, and there may be a loss of precision.



- For connection with a load having an external support/guide mechanism, select an appropriate connection method and perform careful alignment.
- Use caution, as scratches or nicks, etc., on the sliding parts of the piston rod can cause a malfunction and air leakage.

Safety Instructions

These safety instructions are intended to prevent hazardous situations and/or equipment damage. These instructions indicate the level of potential hazard with the labels of “Caution,” “Warning” or “Danger.” They are all important notes for safety and must be followed in addition to International Standards (ISO/IEC)*1), and other safety regulations.

-  **Caution:** Caution indicates a hazard with a low level of risk which, if not avoided, could result in minor or moderate injury.
-  **Warning:** Warning indicates a hazard with a medium level of risk which, if not avoided, could result in death or serious injury.
-  **Danger:** Danger indicates a hazard with a high level of risk which, if not avoided, will result in death or serious injury.

- *1) ISO 4414: Pneumatic fluid power – General rules relating to systems.
- ISO 4413: Hydraulic fluid power – General rules relating to systems.
- IEC 60204-1: Safety of machinery – Electrical equipment of machines. (Part 1: General requirements)
- ISO 10218-1: Manipulating industrial robots - Safety. etc.

Warning

- 1. The compatibility of the product is the responsibility of the person who designs the equipment or decides its specifications.**
Since the product specified here is used under various operating conditions, its compatibility with specific equipment must be decided by the person who designs the equipment or decides its specifications based on necessary analysis and test results. The expected performance and safety assurance of the equipment will be the responsibility of the person who has determined its compatibility with the product. This person should also continuously review all specifications of the product referring to its latest catalogue information, with a view to giving due consideration to any possibility of equipment failure when configuring the equipment.
- 2. Only personnel with appropriate training should operate machinery and equipment.**
The product specified here may become unsafe if handled incorrectly. The assembly, operation and maintenance of machines or equipment including our products must be performed by an operator who is appropriately trained and experienced.
- 3. Do not service or attempt to remove product and machinery/equipment until safety is confirmed.**
 1. The inspection and maintenance of machinery/equipment should only be performed after measures to prevent falling or runaway of the driven objects have been confirmed.
 2. When the product is to be removed, confirm that the safety measures as mentioned above are implemented and the power from any appropriate source is cut, and read and understand the specific product precautions of all relevant products carefully.
 3. Before machinery/equipment is restarted, take measures to prevent unexpected operation and malfunction.
- 4. Contact SMC beforehand and take special consideration of safety measures if the product is to be used in any of the following conditions.**
 1. Conditions and environments outside of the given specifications, or use outdoors or in a place exposed to direct sunlight.
 2. Installation on equipment in conjunction with atomic energy, railways, air navigation, space, shipping, vehicles, military, medical treatment, combustion and recreation, or equipment in contact with food and beverages, emergency stop circuits, clutch and brake circuits in press applications, safety equipment or other applications unsuitable for the standard specifications described in the product catalogue.
 3. An application which could have negative effects on people, property, or animals requiring special safety analysis.
 4. Use in an interlock circuit, which requires the provision of double interlock for possible failure by using a mechanical protective function, and periodical checks to confirm proper operation.

Limited warranty and Disclaimer/ Compliance Requirements

The product used is subject to the following “Limited warranty and Disclaimer” and “Compliance Requirements”.
Read and accept them before using the product.

Limited warranty and Disclaimer

1. The warranty period of the product is 1 year in service or 1.5 years after the product is delivered, whichever is first.*2)
Also, the product may have specified durability, running distance or replacement parts. Please consult your nearest sales branch.
2. For any failure or damage reported within the warranty period which is clearly our responsibility, a replacement product or necessary parts will be provided. This limited warranty applies only to our product independently, and not to any other damage incurred due to the failure of the product.
3. Prior to using SMC products, please read and understand the warranty terms and disclaimers noted in the specified catalogue for the particular products.

*2) Vacuum pads are excluded from this 1 year warranty.

A vacuum pad is a consumable part, so it is warranted for a year after it is delivered. Also, even within the warranty period, the wear of a product due to the use of the vacuum pad or failure due to the deterioration of rubber material are not covered by the limited warranty.

Compliance Requirements

1. The use of SMC products with production equipment for the manufacture of weapons of mass destruction (WMD) or any other weapon is strictly prohibited.
2. The exports of SMC products or technology from one country to another are governed by the relevant security laws and regulations of the countries involved in the transaction. Prior to the shipment of a SMC product to another country, assure that all local rules governing that export are known and followed.

Caution

- 1. The product is provided for use in manufacturing industries.**
The product herein described is basically provided for peaceful use in manufacturing industries.
If considering using the product in other industries, consult SMC beforehand and exchange specifications or a contract if necessary.
If anything is unclear, contact your nearest sales branch.

Caution

SMC products are not intended for use as instruments for legal metrology.
Measurement instruments that SMC manufactures or sells have not been qualified by type approval tests relevant to the metrology (measurement) laws of each country. Therefore, SMC products cannot be used for business or certification ordained by the metrology (measurement) laws of each country.

Safety Instructions

Be sure to read “Handling Precautions for SMC Products” (M-E03-3) before using.

SMC Corporation (Europe)

Austria	☎ +43 (0)2262622800	www.smc.at	office@smc.at	Lithuania	☎ +370 5 2308118	www.smclt.lt	info@smclt.lt
Belgium	☎ +32 (0)33551464	www.smcpnematics.be	info@smcpneumatics.be	Netherlands	☎ +31 (0)205318888	www.smcpnematics.nl	info@smcpneumatics.nl
Bulgaria	☎ +359 (0)2807670	www.smc.bg	office@smc.bg	Norway	☎ +47 67129020	www.smc-norge.no	post@smc-norge.no
Croatia	☎ +385 (0)13707288	www.smc.hr	office@smc.hr	Poland	☎ +48 (0)222119616	www.smc.pl	office@smc.pl
Czech Republic	☎ +420 541424611	www.smc.cz	office@smc.cz	Portugal	☎ +351 226166570	www.smc.eu	postpt@smc.smces.es
Denmark	☎ +45 70252900	www.smcdk.com	smc@smcdk.com	Romania	☎ +40 213205111	www.smcromania.ro	smcromania@smcromania.ro
Estonia	☎ +372 6510370	www.smcpnematics.ee	smc@smcpneumatics.ee	Russia	☎ +7 8127185445	www.smc-pneumatik.ru	info@smc-pneumatik.ru
Finland	☎ +358 207513513	www.smc.fi	smc@smc.fi	Slovakia	☎ +421 (0)413213212	www.smc.sk	office@smc.sk
France	☎ +33 (0)164761000	www.smc-france.fr	promotion@smc-france.fr	Slovenia	☎ +386 (0)73885412	www.smc.si	office@smc.si
Germany	☎ +49 (0)61034020	www.smc.de	info@smc.de	Spain	☎ +34 902184100	www.smc.eu	post@smc.smces.es
Greece	☎ +30 210 2717265	www.smchellas.gr	sales@smchellas.gr	Sweden	☎ +46 (0)86031200	www.smc.nu	post@smc.nu
Hungary	☎ +36 23511390	www.smc.hu	office@smc.hu	Switzerland	☎ +41 (0)523963131	www.smc.ch	info@smc.ch
Ireland	☎ +353 (0)14039000	www.smcpnematics.ie	sales@smcpneumatics.ie	Turkey	☎ +90 212 489 0 440	www.smcpnomatik.com.tr	info@smcpnomatik.com.tr
Italy	☎ +39 0292711	www.smcitalia.it	mailbox@smcitalia.it	UK	☎ +44 (0)845 121 5122	www.smcpnematics.co.uk	sales@smcpneumatics.co.uk
Latvia	☎ +371 67817700	www.smc.lv	info@smclv.lv				

SMC CORPORATION Akihbara UDX 15F, 4-14-1, Sotokanda, Chiyoda-ku, Tokyo 101-0021, JAPAN Phone: 03-5207-8249 FAX: 03-5298-5362