

	Photoelectric proximity switches, BGS
	Photoelectric reflex switches
	Through-beam photoelectric switches

W18-3: Incorporated application know-how, expanded functionality, high level of equipment availability



In Automation Technology, customers demand optical sensors, which can reliably solve complex applications, which are capable of operating at high processing speeds and which provide a high level of in-service availability under arduous operating conditions. The W18-3 Series is recommended. The W18-3 Series is the result of a vast amount of experience and many years of knowledge gathered from thousands of applications, from which the user can now benefit.

Depending upon the task required, the most appropriate sensor can be selected:

With precision background suppression, the WT18-3 Series is ideal for demanding applications.

The scanning distance can be simply and quickly adjusted, either via conventional potentiometer or via double Teach buttons, with fine adjustment option.

WL18-3, using an auto-collimation optical principle, are designed to optically focus upon the object in a reliable manner and utilising a visually defined small red spot of light.

WS/WE18-3 – ideal for applications where greater system reserve is required.

Further advantage:

- The series W18-3 sensors fulfil the test requirements of

ECOLAB®

The main target industries for the W18-3 Series are:

- Packaging industry,
- Food and confectionery industry,
- Storage and conveying,
- Wood processing.

▼ In a picking warehouse, the goods containers are reliably detected by WT18-3, thus ensuring correct goods throughput.



◀ WT18-3 detects the position of a load carrier in front of the shelf bay and optimises the flow of goods in a high-bay warehouse.



▼ From dark to light: WT18-3 reliably monitors the material supply in a spinning machine.



▶ WT18-3 safely detects the shiny coffee packets on a fully-automatic packaging line.



▲ WL18-3 detects the transport hanger and thus enables the smooth throughput of the garments to be washed in a fully-automatic laundry.

 **Scanning distance**
50 ... 600 mm

Photoelectric proximity switches

- Precise background suppression; suitable for high demanding applications
- Scanning range adjustable via potentiometer
- Insensitive to external light sources (HF lamps)
- Operation reliability with equipment facing each other
- Permissible ambient operating temperature $-40\text{ °C} \dots +60\text{ °C}$

Dimensional drawing

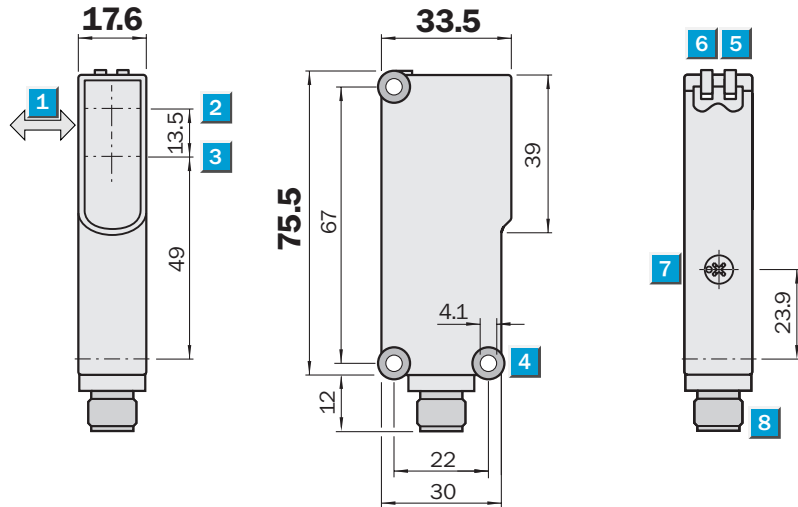

Adjustments possible

All types



- 1** Standard direction of the material being scanned
- 2** Optical axis sender
- 3** Optical axis receiver
- 4** Mounting hole \varnothing 4.1 mm
- 5** LED indicator, yellow; status of received light beam
- 6** LED indicator, green; power on
- 7** Scanning distance adjustment, Poti 4 turn
- 8** Plug M12, 4-pin or 2 m cable



Connection types

WT18-3P130	WT18-3P430
WT18-3N130	WT18-3N430

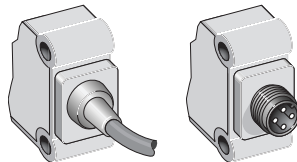

4 x 0.25 mm²

4-pin, M12

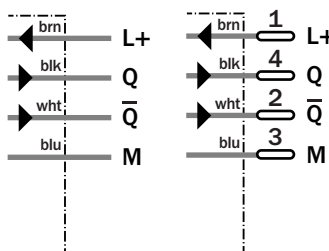

See chapter Accessories

Connectors
Mounting systems

Technical data		WT18-3	P130	P430	N130	N430							
Scanning distance , adjustable ¹⁾	50 ... 600 mm, 90 % remission												
Visible range ¹⁾	10 ... 600 mm												
Adjustment	Poti, 4 turn												
Light source ²⁾ , light type	LED, visible red light												
Light spot diameter	15 mm at 300 mm												
Supply voltage V _S	10 ... 30 V DC ³⁾												
Residual ripple ⁴⁾	< 5 V _{pp}												
Current consumption ⁵⁾	< 40 mA												
Output current I _A max.	< 100 mA												
Switching outputs	PNP, antivalent												
	NPN, antivalent												
Response time ⁶⁾	< 700 μs												
Switching frequency max. ⁷⁾	700/s												
Connection types	Cable ⁸⁾ , 2 m, 4 wire												
	M12 plug, 4-pin												
VDE protection class cable ⁹⁾	<input type="checkbox"/>												
Circuit protection ¹⁰⁾	A, B, C												
Enclosure rating	IP 67												
Ambient temperature	Operation -40 °C ... +60 °C												
	Storage -40 °C ... +75 °C												
Weight	With cable, 2 m, approx. 120 g												
	With M12 plug, approx. 40 g												
Housing material	ABS												

- 1) Object with 90 % remission (according to standard white DIN 5033)
- 2) Average service life 100,000 h at T_A = +25 °C
- 3) Limit values; Operation in short-circuit protected network max. 8 A
- 4) Must be within V_S tolerances
- 5) Without load
- 6) Signal transit time with resistive load
- 7) With light/dark ratio 1:1
- 8) Do not bend below 0 °C
- 9) Reference voltage 50 V DC
- 10) A = V_S connection reverse-polarity protected
B = Outputs short-circuit protected
C = Interference pulse suppression

Adjustment via Poti

1. Position the object in the path of the beam.
2. By rotating the potentiometer to the right until the yellow LED illuminates continuously = object is positively detected.
3. If necessary, fine adjustments to the scanning distance can be made to suit the conditions of the application: minimal rotation of the potentiometer to the right = scanning distance will be increased, minimal rotation of the potentiometer to the left = scanning distance will be decreased.

Scanning distance

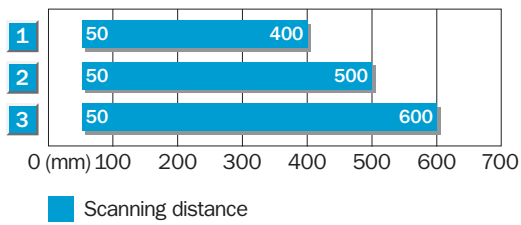

- 1 Scanning distance on black, 6 % remission
- 2 Scanning distance on grey, 18 % remission
- 3 Scanning distance on white, 90 % remission

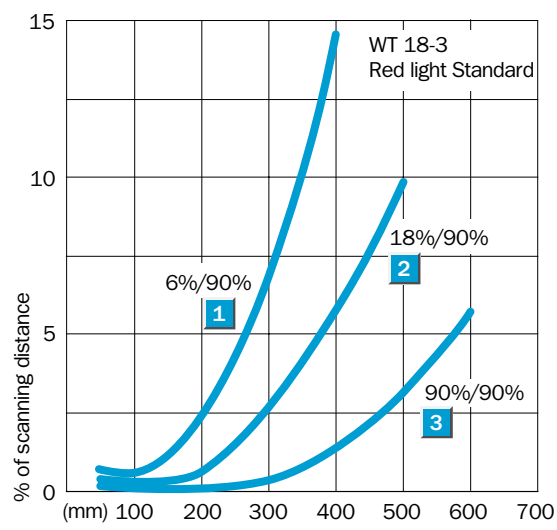

Order information

Type	Order no.
WT18-3P130	1025895
WT18-3P430	1025896
WT18-3N130	1025897
WT18-3N430	1025898

Scanning distance
50 ... 600 mm

Photoelectric proximity switches

- Precise background suppression; suitable for high demanding applications
- Scanning range adjustable by a Teach-in process using double Teach buttons
- Insensitive to external light sources (HF lamps)
- Operation reliability with equipment facing each other
- Permissible ambient operating temperature -40 °C ... +60 °C

Dimensional drawing

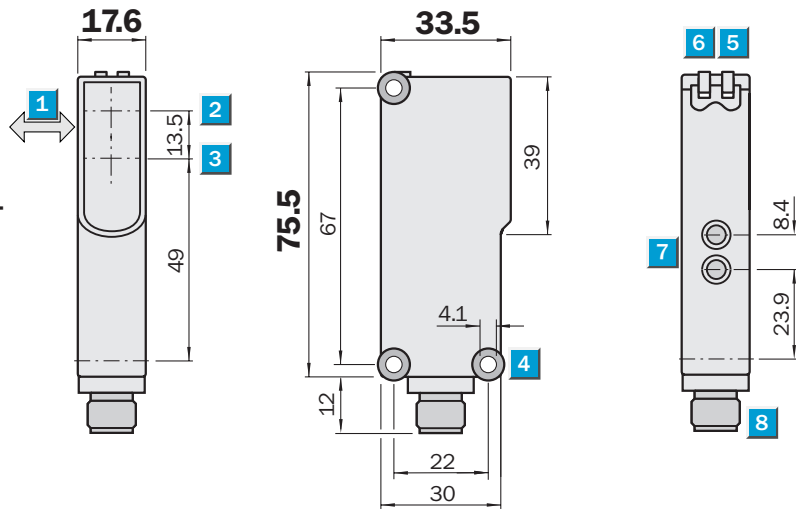

Adjustments possible

All types

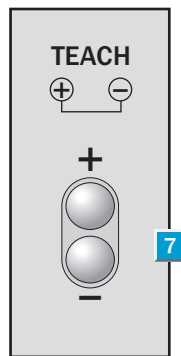

- 1 Standard direction of the material being scanned
- 2 Optical axis sender
- 3 Optical axis receiver
- 4 Mounting hole \varnothing 4.1 mm
- 5 LED indicator, yellow; status of received light beam
- 6 LED indicator, green; power on
- 7 Scanning distance adjustment, double Teach button
- 8 Plug M12, 4-pin or 2 m cable



Connection types

WT18-3P131	WT18-3P431
	WT18-3N431

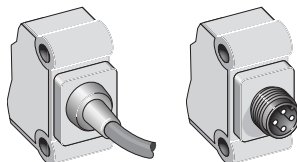

4 x 0.25 mm ²	4-pin, M12
--------------------------	------------

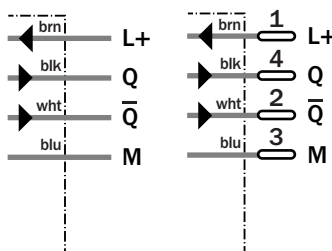

See chapter Accessories

Connectors
Mounting systems

Technical data		WT18-3	P131	P431	N431							
Scanning distance, adjustable ¹⁾	50 ... 600 mm, 90 % remission											
Visible range ¹⁾	10 ... 600 mm											
Adjustment	Teach-in, via double Teach buttons											
Fine adjustment	Manuel via „+“ and „-“ button											
Light source ²⁾ , light type	LED, visible red light											
Light spot diameter	15 mm at 300 mm											
Supply voltage V _S	10 ... 30 V DC ³⁾											
Residual ripple ⁴⁾	< 5 V _{PP}											
Current consumption ⁵⁾	< 40 mA											
Output current I _A max.	< 100 mA											
Switching outputs	PNP, antivalent											
	NPN, antivalent											
Response time ⁶⁾	< 700 μs											
Switching frequency max. ⁷⁾	700/s											
Connection types	Cable ⁸⁾ , 2 m, 4 wire											
	M12 plug, 4-pin											
VDE protection class cable ⁹⁾	<input type="checkbox"/>											
Circuit protection ¹⁰⁾	A, B, C											
Enclosure rating	IP 67											
Ambient temperature	Operation -40 °C ... +60 °C											
	Storage -40 °C ... +75 °C											
Weight	With cable, 2 m, approx. 120 g											
	With M12 plug, approx. 40 g											
Housing material	ABS											

- 1) Object with 90 % remission (according to standard white DIN 5033)
- 2) Average service life 100,000 h at T_A = +25 °C
- 3) Limit values; Operation in short-circuit protected network max. 8 A
- 4) Must be within V_S tolerances
- 5) Without load
- 6) Signal transit time with resistive load
- 7) With light/dark ratio 1:1
- 8) Do not bend below 0 °C
- 9) Reference voltage 50 V DC
- 10) A = V_S connection reverse-polarity protected
B = Outputs short-circuit protected
C = Interference pulse suppression

Teach-in procedure via the double Teach buttons

1. Position the object in the path of the beam.
2. Press both buttons simultaneously (**for approx. 2 seconds**) until the yellow LED flashes = object in focus.
In the event of button activation of less than 2 seconds, the Teach command is not effective, therefore providing no protection against further unwanted manipulation.
3. Release buttons; yellow LED illuminates continuously = object is positively detected.
4. Fine adjustments can be made to the scanning distance, when required by the application:
Pressing the „+“ button (**approx. 0.5 sec**) = scanning distance will be increased.
Pressing the „-“ button (**approx. 0.5 sec**) = scanning distance will be decreased.
In the event of button activation less than 0.5 sec, no change to the scanning distance is made.
Upon activation of the button, the yellow LED flashes.
5. The Teach-in scanning distance is stored in the memory.

Scanning distance

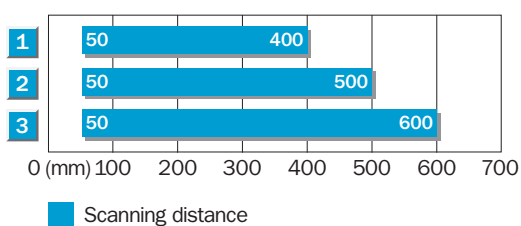

- 1 Scanning distance on black, 6 % remission
- 2 Scanning distance on grey, 18 % remission
- 3 Scanning distance on white, 90 % remission

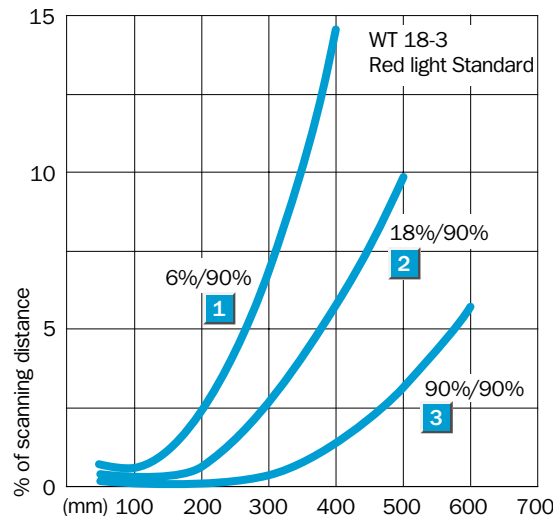

Order information	
Type	Order no.
WT18-3P131	1026034
WT18-3P431	1026032
WT18-3N431	1026035

 **Scanning distance**
50 ... 700 mm

Photoelectric proximity switches

- Precise background suppression; suitable for high demanding applications
- Scanning range adjustable via potentiometer
- Insensitive to external light sources (HF lamps)
- Operation reliability with equipment facing each other
- Permissible ambient operating temperature -40 °C ... +60 °C

Dimensional drawing

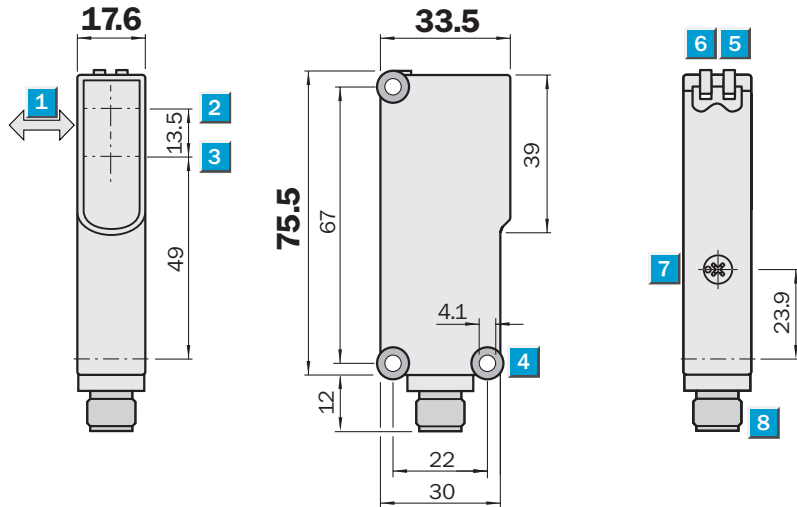

Adjustments possible

All types



- 1 Standard direction of the material being scanned
- 2 Optical axis sender
- 3 Optical axis receiver
- 4 Mounting hole Ø 4.1 mm
- 5 LED indicator, yellow; status of received light beam
- 6 LED indicator, green; power on
- 7 Scanning distance adjustment, Poti 4 turn
- 8 Plug M12, 4-pin or 2 m cable or cubic plug, 6-pin



Connection types

WT18-3P110	WT18-3P410	WT18-3P610
WT18-3N110	WT18-3N410	WT18-3N610

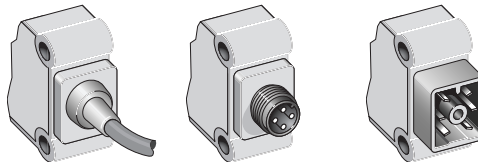

4 x 0.25 mm ²	4-pin, M12	6-pin
--------------------------	------------	-------

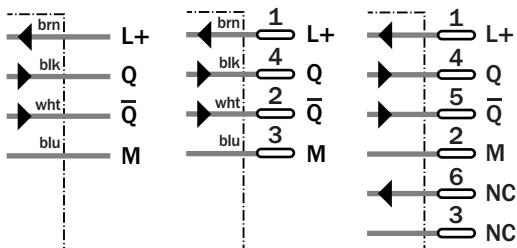

See chapter Accessories

Connectors
Mounting systems

Technical data		WT18-3	P110	P410	P610	N110	N410	N610				
Scanning distance, adjustable¹⁾	50 ... 700 mm, 90 % remission											
Visible range¹⁾	10 ... 700 mm											
Adjustment	Poti, 4 turn											
Light source²⁾, light type	LED, infrared light											
Light spot diameter	20 mm at 400 mm											
Supply voltage V_S	10 ... 30 V DC ³⁾											
Residual ripple ⁴⁾	< 5 V _{SS}											
Current consumption ⁵⁾	< 55 mA											
Output current I _A max.	< 100 mA											
Switching outputs	PNP, antivalent											
	NPN, antivalent											
Response time ⁶⁾	< 700 μs											
Switching frequency max. ⁷⁾	700/s											
Connection types	Cable ⁸⁾ , 2 m, 4 wire											
	M12 plug, 4-pin											
	Cubic plug, 6-pin											
VDE protection class cable⁹⁾	<input type="checkbox"/>											
Circuit protection¹⁰⁾	A, B, C											
Enclosure rating	IP 67											
	IP 65											
Ambient temperature	Operation -40 °C ... +60 °C											
	Storage -40 °C ... +75 °C											
Weight	With cable, 2 m, approx. 120 g											
	With M12 plug, approx. 40 g											
	With cubic plug, approx. 40 g											
Housing material	ABS											

1) Object with 90 % remission (according to standard white DIN 5033)
 2) Average service life 100,000 h at T_A = +25 °C

3) Limit values; Operation in short-circuit protected network max. 8 A
 4) Must be within V_S tolerances
 5) Without load

6) Signal transit time with resistive load
 7) With light/dark ratio 1:1
 8) Do not bend below 0 °C
 9) Reference voltage 50 V DC

10) A = V_S connection reverse-polarity protected
 B = Outputs short-circuit protected
 C = Interference pulse suppression

Adjustment via Poti

1. Position the object in the path of the beam.
2. By rotating the potentiometer to the right until the yellow LED illuminates continuously = object is positively detected.
3. If necessary, fine adjustments to the scanning distance can be made to suit the conditions of the application: minimal rotation of the potentiometer to the right = scanning distance will be increased, minimal rotation of the potentiometer to the left = scanning distance will be decreased.

Scanning distance

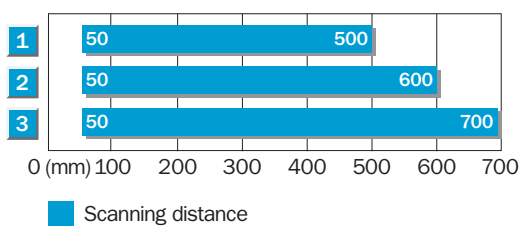

- 1 Scanning distance on black, 6 % remission
- 2 Scanning distance on grey, 18 % remission
- 3 Scanning distance on white, 90 % remission

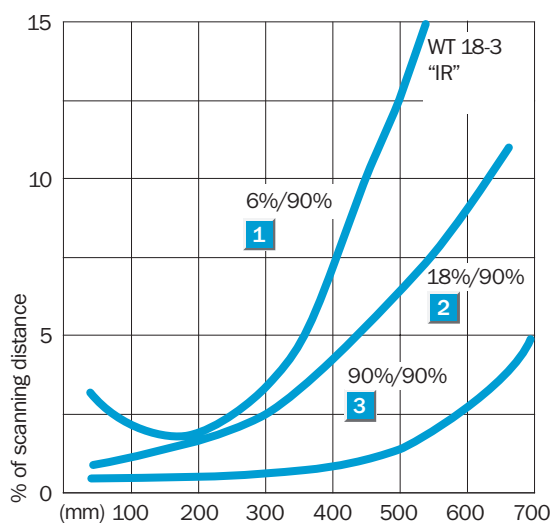

Order information

Type	Order no.
WT18-3P110	1025887
WT18-3P410	1025889
WT18-3P610	1025890
WT18-3N110	1025891
WT18-3N410	1025893
WT18-3N610	1025894

Scanning distance
 50 ... 700 mm
 Photoelectric proximity switches

- Precise background suppression; suitable for high demanding applications
- Scanning range adjustable by a Teach-in process using double Teach buttons
- Insensitive to external light sources (HF lamps)
- Operation reliability with equipment facing each other
- Permissible ambient operating temperature $-40\text{ }^{\circ}\text{C} \dots +60\text{ }^{\circ}\text{C}$

Dimensional drawing

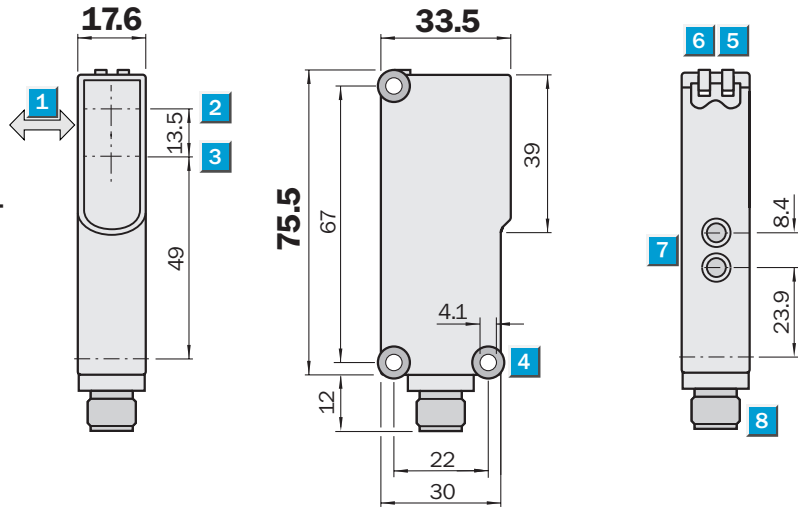

Adjustments possible

All types

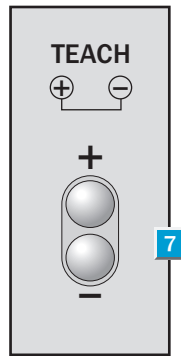

- 1 Standard direction of the material being scanned
- 2 Optical axis sender
- 3 Optical axis receiver
- 4 Mounting hole \varnothing 4.1 mm
- 5 LED indicator, yellow; status of received light beam
- 6 LED indicator, green; power on
- 7 Scanning distance adjustment, double Teach button
- 8 Plug M12, 4-pin or 2 m cable



Connection types

WT18-3P111

WT18-3P411

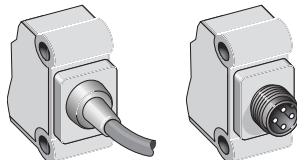

4 x 0.25 mm²

4-pin, M12

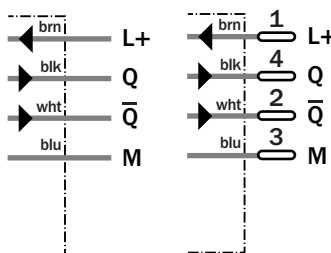

See chapter Accessories

Connectors

Mounting systems

Technical data		WT18-3	P111	P411							
Scanning distance , adjustable ¹⁾	50 ... 700 mm, 90 % remission										
Visible range ¹⁾	10 ... 700 mm										
Adjustment	Teach-in, via double Teach buttons										
Fine adjustment	Manuel via „+“ and „-“ button										
Light source ²⁾ , light type	LED, infrared light										
Light spot diameter	20 mm at 400 mm										
Supply voltage V _S	10 ... 30 V DC ³⁾										
Residual ripple ⁴⁾	< 5 V _{SS}										
Current consumption ⁵⁾	< 55 mA										
Output current I _A max.	< 100 mA										
Switching outputs	PNP, antivalent										
	NPN, antivalent										
Response time ⁶⁾	< 700 μs										
Switching frequency max. ⁷⁾	700/s										
Connection types	Cable ⁸⁾ , 2 m, 4 wire										
	M12 plug, 4-pin										
VDE protection class cable ⁹⁾	<input type="checkbox"/>										
Circuit protection ¹⁰⁾	A, B, C										
Enclosure rating	IP 67										
Ambient temperature	Operation -40 °C ... +60 °C										
	Storage -40 °C ... +75 °C										
Weight	With cable, 2 m, approx. 120 g										
	With M12 plug, approx. 40 g										
Housing material	ABS										

- 1) Object with 90 % remission (according to standard white DIN 5033)
- 2) Average service life 100,000 h at T_A = +25 °C
- 3) Limit values; Operation in short-circuit protected network max. 8 A
- 4) Must be within V_S tolerances
- 5) Without load
- 6) Signal transit time with resistive load
- 7) With light/dark ratio 1:1
- 8) Do not bend below 0 °C
- 9) Reference voltage 50 V DC
- 10) A = V_S connection reverse-polarity protected
B = Outputs short-circuit protected
C = Interference pulse suppression

Teach-in procedure via the double Teach buttons

1. Position the object in the path of the beam.
2. Press both buttons simultaneously (**for approx. 2 seconds**) until the yellow LED flashes = object in focus.
In the event of button activation of less than 2 seconds, the Teach command is not effective, therefore providing no protection against further unwanted manipulation.
3. Release buttons; yellow LED illuminates continuously = object is positively detected.
4. Fine adjustments can be made to the scanning distance, when required by the application:
Pressing the „+“ button (**approx. 0.5 sec**) = scanning distance will be increased.
Pressing the „-“ button (**approx. 0.5 sec**) = scanning distance will be decreased.
In the event of button activation less than 0.5 sec, no change to the scanning distance is made.
Upon activation of the button, the yellow LED flashes.
5. The Teach-in scanning distance is stored in the memory.

Scanning distance

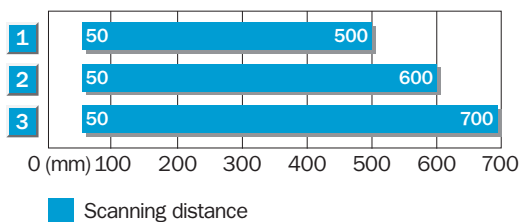

- 1 Scanning distance on black, 6 % remission
- 2 Scanning distance on grey, 18 % remission
- 3 Scanning distance on white, 90 % remission

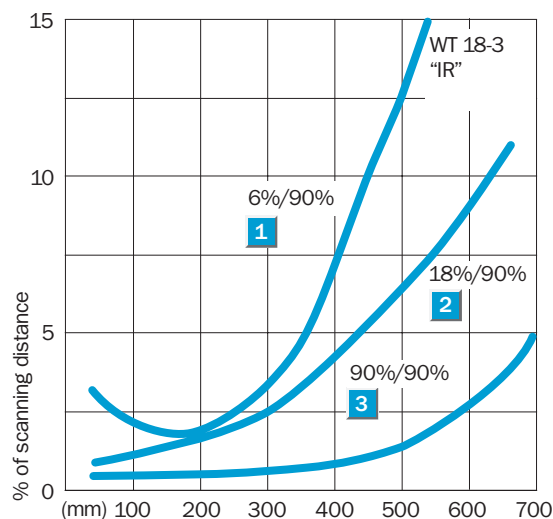

Order information	
Type	Order no.
WT18-3P111	1026033
WT18-3P411	1026031

Scanning distance
50 ... 1000 mm

Photoelectric proximity switches

- Precise background suppression; suitable for high demanding applications
- Scanning range adjustable via potentiometer
- Insensitive to external light sources (HF lamps)
- Operation reliability with equipment facing each other
- Permissible ambient operating temperature $-40\text{ °C} \dots +60\text{ °C}$

Dimensional drawing

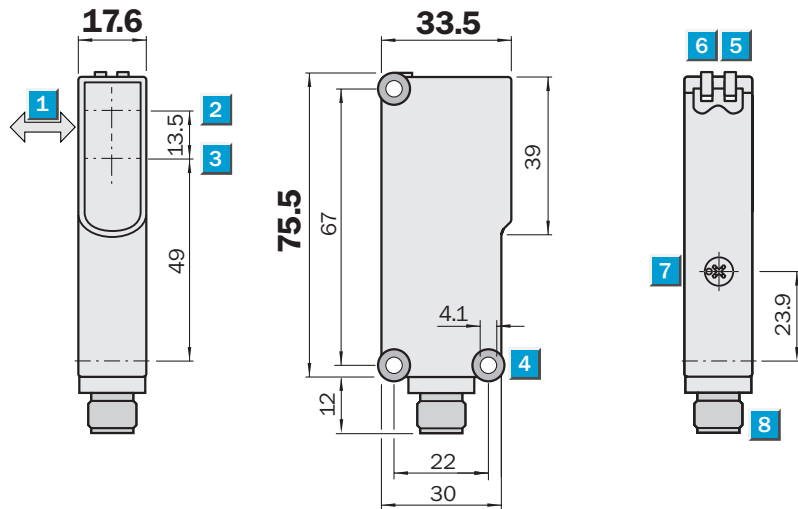

Adjustments possible

All types



- 1 Standard direction of the material being scanned
- 2 Optical axis sender
- 3 Optical axis receiver
- 4 Mounting hole \varnothing 4.1 mm
- 5 LED indicator, yellow; status of received light beam
- 6 LED indicator, green; power on
- 7 Scanning distance adjustment, Poti 4 turn
- 8 Plug M12, 4-pin or 2 m cable



Connection types

WT18-3P120

WT18-3P420

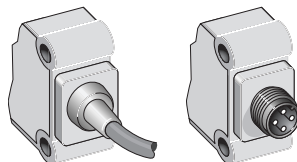

4 x 0.25 mm²

4-pin, M12

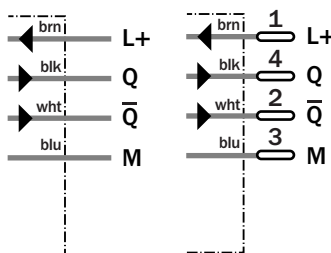

See chapter Accessories

Connectors

Mounting systems

Technical data		WT18-3	P120	P420								
Scanning distance, adjustable ¹⁾	50 ... 1000 mm, 90 % remission											
Visible range ¹⁾	10 ... 1000 mm											
Adjustment	Poti, 4 turn											
Light source ²⁾ , light type	LED, infrared light											
Light spot diameter	30 mm at 600 mm											
Supply voltage V_S	10 ... 30 V DC ³⁾											
Residual ripple ⁴⁾	< 5 V_{SS}											
Current consumption ⁵⁾	< 55 mA											
Output current I_A max.	< 100 mA											
Switching outputs	PNP, antivalent											
Response time ⁶⁾	< 700 μ s											
Switching frequency max. ⁷⁾	700/s											
Connection types	Cable ⁸⁾ , 2 m, 4 wire											
	M12 plug, 4-pin											
VDE protection class cable ⁹⁾	<input type="checkbox"/>											
Circuit protection ¹⁰⁾	A, B, C											
Enclosure rating	IP 67											
Ambient temperature	Operation -40 °C ... +60 °C											
	Storage -40 °C ... +75 °C											
Weight	With cable, 2 m, approx. 120 g											
	With M12 plug, approx. 40 g											
Housing material	ABS											

- 1) Object with 90 % remission (according to standard white DIN 5033)
- 2) Average service life 100,000 h at $T_A = +25$ °C
- 3) Limit values; Operation in short-circuit protected network max. 8 A
- 4) Must be within V_S tolerances
- 5) Without load
- 6) Signal transit time with resistive load
- 7) With light/dark ratio 1:1
- 8) Do not bend below 0 °C
- 9) Reference voltage 50 V DC
- 10) A = V_S connection reverse-polarity protected
B = Outputs short-circuit protected
C = Interference pulse suppression

Adjustment via Poti

1. Position the object in the path of the beam.
2. By rotating the potentiometer to the right until the yellow LED illuminates continuously = object is positively detected.
3. If necessary, fine adjustments to the scanning distance can be made to suit the conditions of the application: minimal rotation of the potentiometer to the right = scanning distance will be increased, minimal rotation of the potentiometer to the left = scanning distance will be decreased.

Scanning distance

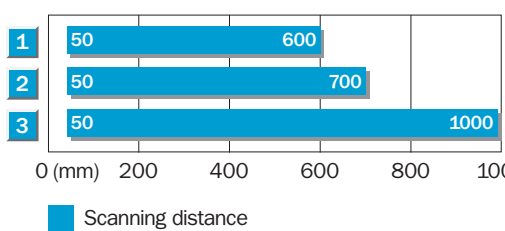

- 1 Scanning distance on black, 6 % remission
- 2 Scanning distance on grey, 18 % remission
- 3 Scanning distance on white, 90 % remission

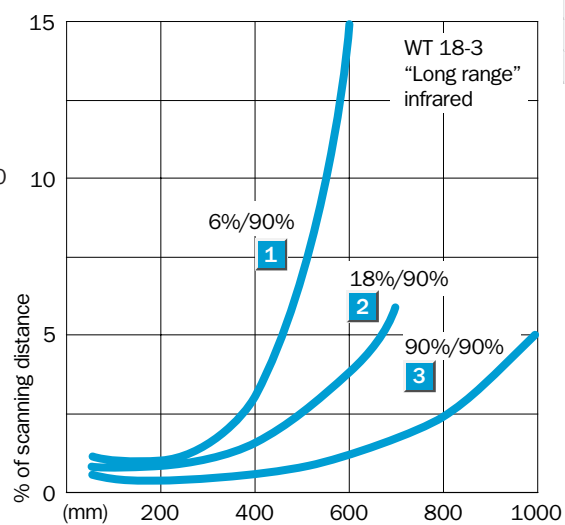

Order information	
Type	Order no.
WT18-3P120	1025904
WT18-3P420	1025905

Scanning range
7 m

Photoelectric reflex switches

- Autocollimation optics; reliable target detection
- Insensitive to external light sources (HF lamps)
- Operation reliability with equipment facing each other
- Permissible ambient operating temperature $-40\text{ °C} \dots +60\text{ °C}$
- Test input for system diagnosis (optional)

Dimensional drawing

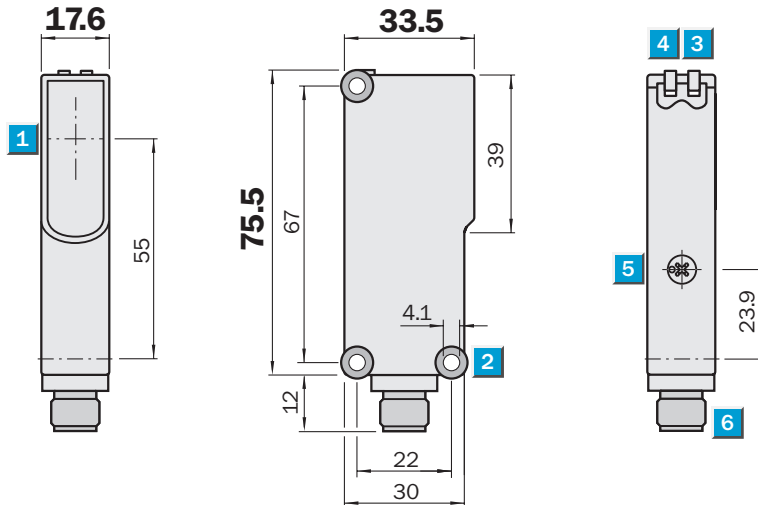

Adjustments possible

All types



- 1 Middle of optical axis
- 2 Mounting holes $\varnothing 4.1\text{ mm}$
- 3 Status indicator LED, yellow, status of received light beam
- 4 Status indicator LED, green; power on
- 5 Sensitivity control; Poti 270°
- 6 Plug M12, 4-pin or cable 2 m or cubic plug 6 pin



Connection types

WL18-3P130	WL18-3P430	WL18-3P630	WL18-3P730
WL18-3N130	WL18-3N430	WL18-3N630	WL18-3N730

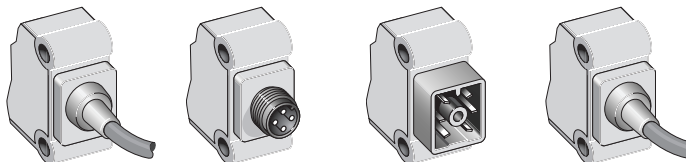

4 x 0.25 mm²

4-pin, M12

6-pin

5 x 0.25 mm²

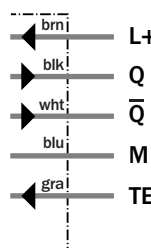
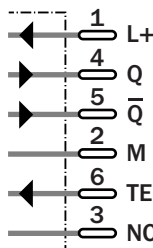
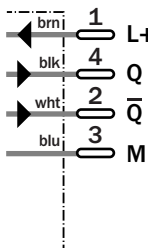
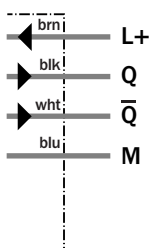

See chapter Accessories

- Connectors
- Reflectors
- Mounting systems

Technical data	WL18-3	P130	P430	P630	P730	N130	N430	N630	N730		
Scanning range , max. typ./on reflector	7 m/PL80A										
Sensitivity	Adjustable, via Poti, 270°										
Light source ¹⁾, light type	LED, visible red light										
Angle of dispersion	4°										
Light spot diameter	40 mm at 2 m										
Polarising filter	Yes										
Supply voltage V_S	10 ... 30 V DC ²⁾										
Residual ripple ⁴⁾	< 5 V _{pp}										
Current consumption ⁵⁾	< 40 mA										
Output current I_A max.	< 100 mA										
Switching outputs	PNP, antivalent										
	NPN, antivalent										
Response time ⁵⁾	500 µs										
Switching frequency max. ⁶⁾	1000/s										
Test input »TE«	PNP: Sender off; TE to 0 V										
	NPN: Sender off; TE to V+										
Connection types	Cable ⁷⁾ , 2 m, 4 wire										
	M12 plug, 4-pin										
	Cubic plug, 6-pin										
	Cable, 2 m, 5 wire										
VDE protection class cable ⁸⁾	<input type="checkbox"/>										
Circuit protection ⁹⁾	A, B, C										
Enclosure rating	IP 67										
	IP 65										
Ambient temperature	Operation -40 °C ... +60 °C										
	Storage -40 °C ... +75 °C										
Weight	With cable, 2 m, approx. 120 g										
	With M12 plug, approx. 40 g										
	With cubic plug, ca. 40 g										
Housing material	ABS										

1) Average service life 100,000 h at $T_A = +25 °C$
 2) Limit values; Operation in short-circuit protected network max. 8 A
 3) Must be within V_S tolerances
 4) Without load
 5) Signal transit time with resistive load
 6) With light/dark ratio 1:1
 7) Do not bend below 0 °C
 8) Reference voltage 50 V DC
 9) A = V_S connection reverse-polarity protected
 B = Outputs short-circuit protected
 C = Interference pulse suppression

Scanning range

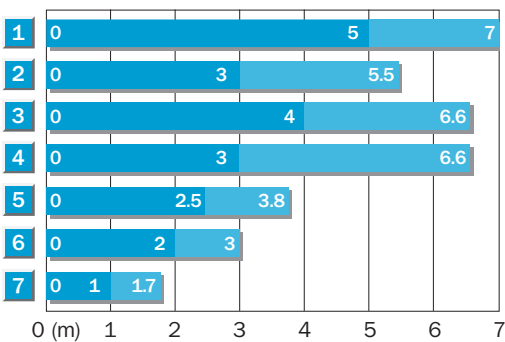

Reflector type	Operating range
1 PL 80 A	0 ... 5.0 m
2 C 110	0 ... 3.0 m
3 PL 50 A	0 ... 4.0 m
4 PL 40 A	0 ... 3.0 m
5 PL 30 A	0 ... 2.5 m
6 PL 20 A	0 ... 2.0 m
7 Reflective tape Diamond Grade	0 ... 1.0 m

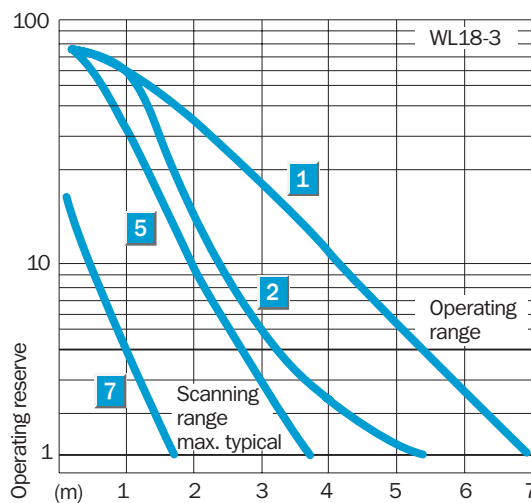

Order information

Type	Order no.
WL18-3P130	1025909
WL18-3P430	1025911
WL18-3P630	1025912
WL18-3P730	1026029
WL18-3N130	1025913
WL18-3N430	1025915
WL18-3N630	1025916
WL18-3N730	1026030

	Scanning range 7 m
Photoelectric reflex switches	

- Autocollimation optics; reliable target detection
- Insensitive to external light sources (HF lamps)
- Operation reliability with equipment facing each other
- Permissible ambient operating temperature $-40\text{ }^{\circ}\text{C} \dots +60\text{ }^{\circ}\text{C}$
- Test input for system diagnosis (optional)

Dimensional drawing

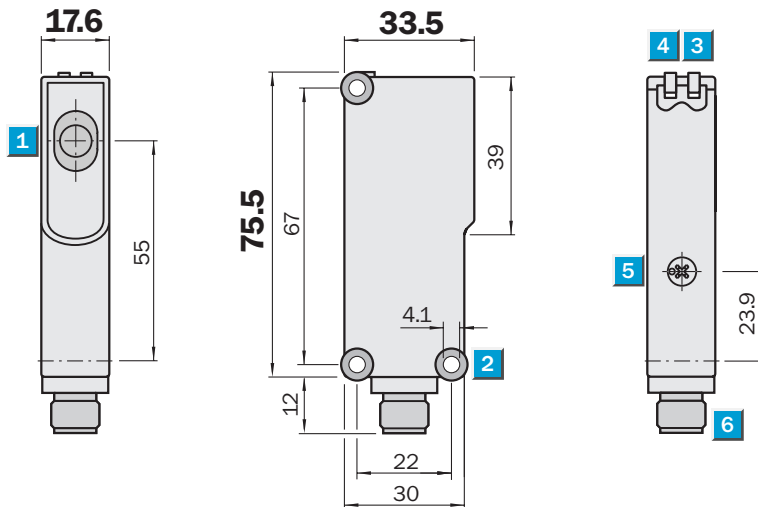

Adjustments possible

All types



- 1 Middle of optical axis
- 2 Mounting holes $\varnothing 4.1\text{ mm}$
- 3 Status indicator LED, yellow, status of received light beam
- 4 Status indicator LED, green; power on
- 5 Sensitivity control; Poti 270°
- 6 Plug M12, 4-pin or cubic plug 6-pin



Connection types

WL18-3P480

WL18-3P680

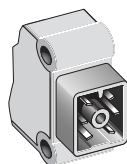
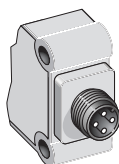

4-pin, M12

6-pin

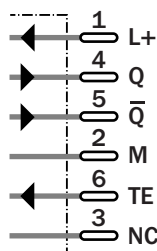
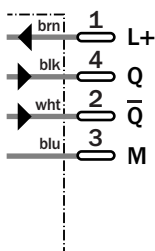

See chapter Accessories

Connectors

Reflectors

Mounting systems

Technical data		WL18-3	P480	P680								
Scanning range , max. typ./on reflector	7 m/PL80A											
Sensitivity	Adjustable, via Poti, 270°											
Light source ¹⁾, light type	LED, visible red light											
Angle of dispersion	1,8°											
Light spot diameter	40 mm at 2 m											
Polarising filter	No											
Supply voltage V_S	10 ... 30 V DC ²⁾											
Residual ripple ⁴⁾	< 5 V _{pp}											
Current consumption ⁵⁾	< 40 mA											
Output current I _A max.	< 100 mA											
Switching outputs	PNP, antivalent											
Response time ⁵⁾	500 μs											
Switching frequency max. ⁶⁾	1000/s											
Test input »TE«	PNP: Sender off; TE to 0 V											
Connection types	M12 plug, 4-pin											
	Cubic plug, 6-pin											
VDE protection class cable ⁷⁾	<input type="checkbox"/>											
Circuit protection ⁸⁾	A, B, C											
Enclosure rating	IP 67											
	IP 65											
Ambient temperature	Operation -40 °C ... +60 °C											
	Storage -40 °C ... +75 °C											
Weight	With M12 plug, approx. 40 g											
	With cubic plug, ca. 40 g											
Housing material	ABS											

1) Average service life 100,000 h at T_A = +25 °C

2) Limit values; Operation in short-circuit protected network max. 8 A

3) Must be within V_S tolerances

4) Without load

5) Signal transit time with resistive load

6) With light/dark ratio 1:1

7) Do not bend below 0 °C

8) Reference voltage 50 V DC

9) A = V_S connection reverse-polarity protected

B = Outputs short-circuit protected

C = Interference pulse suppression

Scanning range

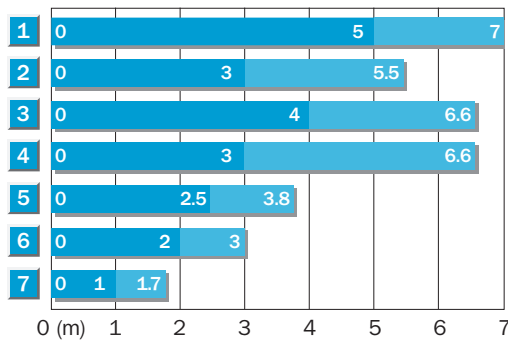

■ Operating range ■ Scanning range, max. typical

Reflector type	Operating range
1 PL 80 A	0 ... 5.0 m
2 C 110	0 ... 3.0 m
3 PL 50 A	0 ... 4.0 m
4 PL 40 A	0 ... 3.0 m
5 PL 30 A	0 ... 2.5 m
6 PL 20 A	0 ... 2.0 m
7 Reflective tape Diamond Grade	0 ... 1.0 m

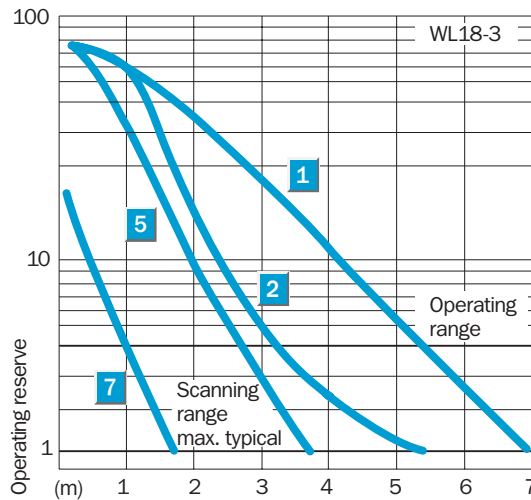

Order information

Type	Order no.
WL18-3P480	1025917
WL18-3P680	1025918

Scanning range
20 m

Through-beam photoelectric switches

- Insensitive to external light sources (HF lamps)
- Permissible ambient operating temperature -40 °C ... +60 °C
- Test input; for device diagnosis
- Rugged plastic housing

Dimensional drawing

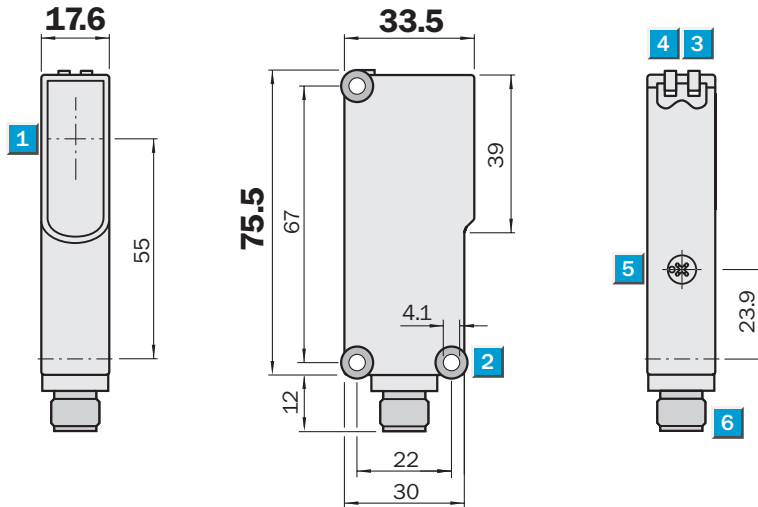

Adjustments possible

All types



- 1 Middle of optical axis
- 2 Mounting holes \varnothing 4.1 mm
- 3 Status indicator LED, yellow, status of received light beam
- 4 Status indicator LED, green; power on
- 5 Sensitivity control; Potentiometer 270° on WE
- 6 Plug M12, 4-pin or cable 2 m or cubic plug 6-pin



Connection types

WS/WE18-3P130

WS/WE18-3P430

WS/WE18-3P630

WS/WE18-3N130

WS/WE18-3N630

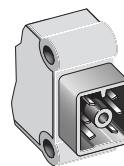
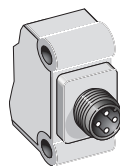
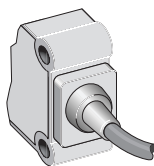

3 x 0.25 mm²

4-pin, M12

6-pin

Sender

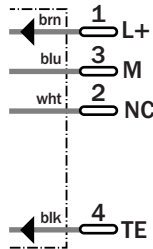
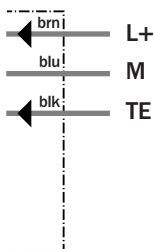

See chapter Accessories

Connectors

Mounting systems

Receiver

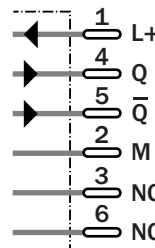
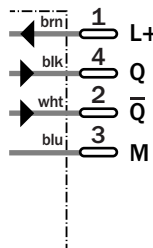
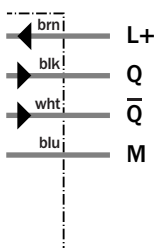

Technical data		WS/WE18-3	P130	P430	P630	N130	N630						
Scanning range , max. typ.	0 ... 20 m												
Sensitivity	Adjustable, via Poti, 270°												
Light source ¹⁾ , light type	LED, visible red light												
Light spot diameter	450 mm at 15 m												
Angle of dispersion	Approx. 1,5°												
Angle of reception	Approx. 2°												
Supply voltage V_S	10 ... 30 V DC ²⁾												
Residual ripple ⁴⁾	< 5 V_{pp}												
Current consumption ⁴⁾	Sender < 45 mA												
	Receiver < 35 mA												
Output current I_A max.	< 100 mA												
Switching outputs	PNP, antivalent												
	NPN, antivalent												
Response time ⁵⁾	500 μs												
Switching frequency max. ⁶⁾	1000/s												
Test input »TE« Sender off	TE to 0 V (WS)												
Connection types	Cable ⁷⁾ , 2 m, 4 wire												
	M12 plug, 4-pin												
	Cubic plug, 6-pin												
VDE protection class cable ⁸⁾	<input type="checkbox"/>												
Circuit protection ⁹⁾	A, B, C												
Enclosure rating	IP 67												
	IP 65												
Ambient temperature	Operation -40 °C ... +60 °C												
	Storage -40 °C ... +75 °C												
Weight	With cable, 2 m, approx. 120 g												
	With M12 plug, approx. 40 g												
	With cubic plug, ca. 40 g												
Housing material	ABS												

1) Average service life 100,000 h at $T_A = +25\text{ °C}$

2) Limit values; Operation in short-circuit protected network max. 8 A

3) Must be within V_S tolerances

4) Without load

5) Signal transit time with resistive load

6) With light/dark ratio 1:1

7) Do not bend below 0 °C

8) Reference voltage 50 V DC

9) A = V_S connection reverse-polarity protected

B = Outputs short-circuit protected

C = Interference pulse suppression

Scanning range and operating reserve

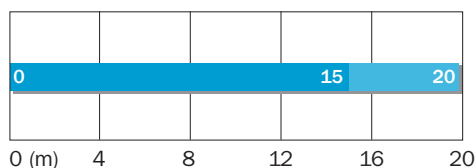

■ Operating range ■ Scanning range, max. typical

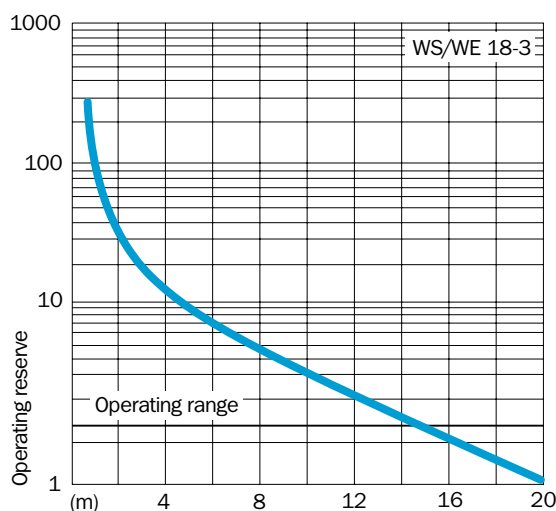

Order information

Type	Order no.
WS/WE18-3P130	1025922
WS/WE18-3P430	1025923
WS/WE18-3P630	1025924
WS/WE18-3N130	1025925
WS/WE18-3N630	1025926