

Remote Maintenance



EMF2180IB

EthernetCAN -----

Communication Manual

EN



13519946

Contents

1	About this documentation	4
1.1	Document history	5
1.2	Conventions used	6
1.3	Terminology used	7
1.4	Definition of the notes used	8
2	Safety instructions	9
2.1	General safety instructions and application notes	9
2.2	Device and application-specific safety instructions	10
2.3	Residual hazards	10
3	Product description	11
3.1	Application as directed	11
3.2	Identification	12
3.3	Connections and interfaces	12
4	Technical data	13
4.1	General data and operating conditions	13
4.2	Protective insulation	14
4.3	Dimensions	15
5	Installation	16
5.1	Mechanical installation	17
5.1.1	Mounting	17
5.1.2	Dismounting	18
5.2	Electrical installation	19
5.2.1	Communication via Ethernet and CAN	19
5.2.2	Connecting the CAN bus	20
5.2.2.1	Assignment of the 9-pin Sub-D plug connector	21
5.2.2.2	Specification of the CAN bus cable	21
5.2.3	Bus cable length (CAN)	22
5.2.3.1	Total cable length	22
5.2.3.2	Segment cable length	23
5.2.3.3	Checking the use of repeaters	24
5.2.4	Connecting the Ethernet cable	25
5.2.4.1	Ethernet cable specification	26
5.2.4.2	Pin assignment and use of the Ethernet cable	28
5.2.5	Voltage supply	29
6	Commissioning	31
6.1	Commissioning with the Lenze "System bus configurator"	31
6.1.1	Installing/updating software	31
6.1.2	Configuring the communication module	32
6.1.3	After completing the configuration	34
6.2	Commissioning with the web server	35
6.2.1	Assigning a fixed IP address	37
6.2.2	Assigning a dynamic IP address	38
6.2.3	Entering a user name and password	40
6.2.4	Firmware update ("FW update")	40
6.2.5	Displaying Ethernet states	41
6.2.6	Displaying alarms and events	42
6.3	Before initial switch-on	43
6.4	Initial switch-on	44
6.4.1	Signalling sequence of the LEDs	44
6.4.2	LED signalling in compliance with DR303-3	45

Contents

7	Data transfer	46
7.1	Access to the inverter codes	46
7.2	Data transfer via CAN	47
7.3	Data transfer via Ethernet	48
8	Diagnostics	49
8.1	Error: Cause and remedy	49
8.2	LED status displays for the communication module and for CAN communication	49
8.3	LED status displays for Ethernet communication	51
9	Parameter reference	52
10	CANopen objects implemented	65
	Index	67
	Your opinion is important to us	69

1 About this documentation

1 About this documentation

Contents

This documentation exclusively describes the EMF2180IB communication module (EthernetCAN).



Note!

This documentation supplements the **mounting instructions** supplied with the communication module.

The mounting instructions contain safety instructions which must be observed!

The features and functions of the communication module are described in detail.

Typical applications are illustrated by means of examples.

The theoretical context is only explained as far as it is required for understanding the function of the communication module.

This documentation does not describe any software provided by other manufacturers. No warranty can be given for corresponding data provided in this documentation. For information on how to use the software, please refer to the host (PLC, IO Controller) documents.

All product names mentioned in this documentation are trademarks of their corresponding owners.

Target group

This documentation is intended for all persons who plan, install, commission and maintain the networking and remote servicing of a machine.



Tip!

Current documentation and software updates with regard to Lenze products can be found in the download area at:

www.lenze.com

Validity

The information given in this documentation applies to the following devices:

Extension module	Type designation	From hardware version	From software version
EthernetCAN communication module	EMF2180IB	1x	1x

Screenshots/application examples

All screenshots in this documentation are application examples. Depending on the firmware version of the communication module and the software version of the engineering tools installed (e.g. »Engineer«), the screenshots in this documentation may differ from the actual screen representation.

1 About this documentation

1.1 Document history



1.1 Document history

Version			Description
5.1	09/2016	TD17	Updated: ▶ Application as directed (📖 11)
5.0	07/2014	TD17	<ul style="list-style-type: none">• New layout• General corrections
4.0	09/2012	TD06	Commissioning with the web server supplemented
3.0	04/2009	TD16	Publication as online help for the Lenze »Engineer«
2.0	03/2005	TD06	<ul style="list-style-type: none">• Update for the system bus configurator V1.2• Lenze codes supplemented
1.0	11/2004	TD06	First edition

1 About this documentation

1.2 Conventions used

This documentation uses the following conventions to distinguish between different types of information:

Type of information	Writing	Examples/notes
Notation of numbers		
Decimal	Standard notation	Example:1234
Decimal separator	Point	The decimal point is used throughout this documentation. for example: 1234.56
Hexadecimal	0x[0 ... 9, A ... F]	Example: 0x60F4
Binary • Nibble	In quotation marks Point	Example: '100' Example: '0110.0100'
Text		
Version information	Blue text colour	All information that applies to from a certain software version of the device onwards is marked accordingly in this documentation. Example: This function extension is available from software version V3.0 onwards!
Program name	" "	The Lenze PC software »Engineer«...
Control element	Bold	The OK button... / the Copy command... / the Characteristics tab... / the Name input field...
Sequence of menu commands		If several commands are required to execute one function, the single commands are separated by an arrow: Select the File → Open command to...
Hyperlink	<u>Underlined</u>	Optically highlighted reference to another topic. It is activated with a mouse-click in this online documentation.
Symbols		
Page reference	 8	Optically highlighted reference to another page. In this online documentation activated via mouse-click.
Step-by-step instructions		Step-by-step instructions are identified by a pictograph.

1 About this documentation

1.3 Terminology used

1.3 Terminology used

Term	Meaning
Code	Parameter which serves to parameterise and monitor the drive. In normal usage, the term is usually referred to as "index".
Subcode	If a code contains several parameters they are stored in so-called "subcodes". In the documentation, the slash "/" is used as a separator between the code and the subcode (e.g. "C00118/3"). In everyday language, the term is also referred to as "subindex".
Use DHCP	The "Dynamic Host Configuration Protocol" (DHCP) is a communication protocol providing for the assignment of the network configuration to clients by a server.
Engineering PC	The Engineering PC and the Engineering tools installed serve to configure and parameterise the system. The Engineering PC communicates with the controller via Ethernet.
Engineering tools	Lenze software solutions for the configuration and commissioning of Lenze devices. The EMF2180IB communication module is configured via the "System bus configurator", which is part of the following Engineering tools: <ul style="list-style-type: none">• »EASY Starter«• »Application Loader«• »Engineer«• »Drive Server«, from version 1.1 onwards• »Drive PLC Developer Studio« (DDS), from version 2.2 onwards• »Global Drive Control« (GDC), from version 4.7 onwards• »Global Drive Loader« (GDL), from version 2.2 onwards ▶ Commissioning (31)
Inverter	Generic term for Lenze frequency inverter, servo inverter
FW	Firmware
HW	Hardware
SW	Software

1 About this documentation

1.4 Definition of the notes used

1.4 Definition of the notes used

This documentation uses the following signal words and symbols to indicate dangers and important information:

Safety instructions

Structure of the safety instructions:



Danger!

(characterises the type and severity of danger)

Note

(describes the danger and gives information about how to prevent dangerous situations)

Pictograph	Signal word	Meaning
	Danger!	Danger of personal injury through dangerous electrical voltage Reference to an imminent danger that may result in death or serious personal injury if the corresponding measures are not taken.
	Danger!	Danger of personal injury through a general source of danger Reference to an imminent danger that may result in death or serious personal injury if the corresponding measures are not taken.
	Stop!	Danger of property damage Reference to a possible danger that may result in property damage if the corresponding measures are not taken.

Application notes

Pictograph	Signal word	Meaning
	Note!	Important note to ensure troublefree operation
	Tip!	Useful tip for simple handling
		Reference to another documentation

2 Safety instructions

2.1 General safety instructions and application notes

2 Safety instructions



Note!

It is absolutely vital that the stated safety measures are implemented in order to prevent serious injury to persons and damage to material assets.

Always keep this documentation to hand in the vicinity of the product during operation.

2.1 General safety instructions and application notes



Danger!

If the following basic safety measures are disregarded, severe injuries to persons and damage to material assets may result.

Lenze drive and automation components ...

- must only be used as directed.
 - ▶ [Application as directed](#) (11)
- must never be commissioned if they display any signs of damage.
- must never be technically modified.
- must never be commissioned if they are not fully mounted.
- must never be operated without the required covers.
- during and after operation can have live, moving and rotating parts, depending on their degree of protection. Surfaces can be hot.

For Lenze drive components ...

- only use the accessories approved.
- only use genuine spare parts supplied by the manufacturer of the product.

observe all specifications contained in the enclosed documentation and related documentation.

- These are the conditions for safe and troublefree operation and the achievement of the specified product features.
- The specifications, processes, and circuitry described in this document are for guidance only and must be adapted to your own specific application. Lenze does not take responsibility for the suitability of the process and circuit proposals.

All works on and with Lenze drive and automation components must only be carried out by qualified personnel. As specified by IEC 60364 or CENELEC HD 384 these are persons who ...

- are familiar with installing, commissioning and operating the product.
- have the qualifications necessary for their occupation.
- know and are able to apply all regulations for the prevention of accidents, directives and laws that apply to the location of use.

2.2 Device and application-specific safety instructions

- During operation, the communication module must be firmly connected to the inverter.
- Only use cables that meet the specifications listed.
 - ▶ [Specification of the CAN bus cable](#) (☞ 21)
 - ▶ [Ethernet cable specification](#) (☞ 26)
- Decouple your Ethernet home network from the system network for Ethernet-capable Lenze devices in order to prevent Ethernet communication faults.
 - ▶ [Connecting the Ethernet cable](#) (☞ 25)
- Before switching on the mains voltage, check ...
 - the entire wiring for completeness, short circuit and earth fault:
 - whether the bus system is terminated through a bus terminating resistor at the first and last physical bus station.
 - ▶ [Connecting the CAN bus](#) (☞ 20)



Documentation for the inverter, control system, system/machine

All the other measures prescribed in this documentation must also be implemented. Observe the safety instructions and application notes contained in this manual.

2.3 Residual hazards

Device protection

- The communication module contains electronic components which may be damaged or destroyed by electrostatic discharge.
 - ▶ [Installation](#) (☞ 16)
- To prevent the RJ45 socket from being damaged, insert or remove the Ethernet cable connector straight (at a right angle) into or from the socket.
 - ▶ [Connecting the Ethernet cable](#) (☞ 25)
- Observe the following to prevent any damage to the plug-on terminal strips and contacts:
 - Wire the plug-on terminal strips first, then plug them on.
 - Plug-on terminal strips that are not assigned must also be plugged on.
 - ▶ [Voltage supply](#) (☞ 29)

3 Product description

3.1 Application as directed

3 Product description

3.1 Application as directed

The communication module ...

- by remote maintenance is used for the parameterisation or programming, commissioning and diagnostics of the applicable Lenze devices;
- is suitable for the transmission of IEC61131 programs, application data (such as profile data) and parameter data;
- is a device intended for use in industrial power systems;
- should only be used under the operating conditions prescribed in this documentation.

Simultaneous access from 2 PCs on the EMF2180IB communication module is not allowed.

Any other use shall be deemed inappropriate!

Application range

The communication module can be used with the following Lenze devices:

- Inverter of the i-series which are supporting CAN
- Inverter Drives 8400, 8400 motec, 8400 protec
- Servo Drives 9400
- 9300 servo inverter
- 9300 vector
- 9300 Servo PLC
- ECS servo system
- 8200 motec motor inverter
- 8200 vector frequency inverter
- Drive PLC
- 82XX frequency inverter
- starttec motor starter
- Terminal extension 9374
- Control / display unit (EPM-HXXX)
- I/O system IP20 (EPM-TXXX)

3 Product description

3.2 Identification

3.2 Identification

The type designation, hardware version and software version of a communication module are indicated on its nameplate:

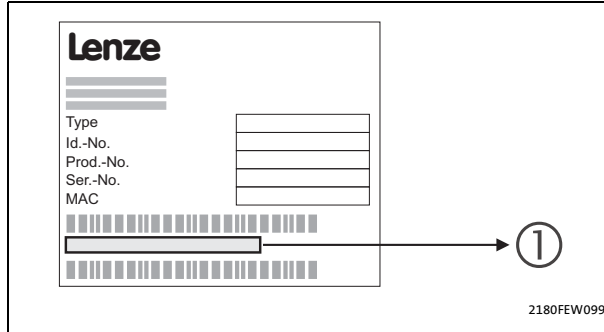

- 1 "33.2180Bxxyy" type designation:
- 33.2180B: device series
 - xx: hardware version
 - yy: software version

[3-1] Identification data

3.3 Connections and interfaces

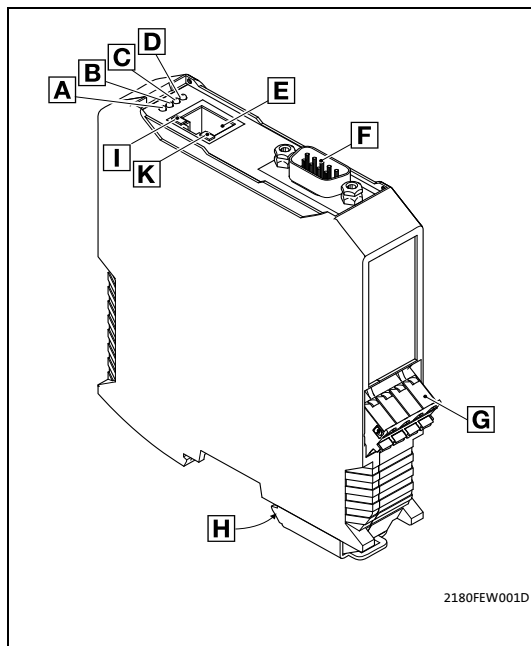

A ... D [LED status displays for the communication module and for CAN communication \(49\)](#)

E Ethernet connection
RJ45 socket with 2 LED status displays

F CAN connection
9-pole Sub-D plug connector

G Voltage supply
4-pole plug connector with spring connection

H PE connection
When it is plugged in, the communication module is automatically connected to the DIN rail.
The DIN rail must be connected to PE!

I, K [LED status displays for Ethernet communication \(51\)](#)

[3-2] EMF2180IB communication module (EthernetCAN)

4 Technical data

4.1 General data and operating conditions

4 Technical data

4.1 General data and operating conditions

Range	Values
Order designation	EMF2180IB
Communication media (system)	CAN (ISO 11898) Ethernet (100 Base TX, IEEE802.3u)
Number of nodes at the CAN bus	Max. 100
Baud rate	<ul style="list-style-type: none"> • For communication via CAN <ul style="list-style-type: none"> • 20 kbps • 50 kbps • 125 kbps • 250 kbps • 500 kbps • 1000 kbps • For communication via Ethernet <ul style="list-style-type: none"> • 10 Mbps • 100 Mbps
Voltage supply (external) via separate power supply unit	18 ... 30 V DC, max. 100 mA (in compliance with IEC/EN 61131-2)

Conformity and Approbation			
CE	See hardware manual of the used inverter.		
UL	See hardware manual of the used inverter.		
EAC	TP TC 020/2011 (TR ZU 020/2011)	Electromagnetic compatibility of technical means	Eurasian Conformity TR CU: Technical Regulation of Customs Union
	TP TC 004/2011 (TR ZU 004/2011)	On safety of low voltage equipment	

Operating conditions	Values	Deviations from standard
Climatic conditions		
Storage	1 K3 to IEC/EN 60721-3-1	- 10 °C ... + 60 °C
Transport	2 K3 to IEC/EN 60721-3-2	- 10 °C ... + 70 °C
Operation	3 K3 to IEC/EN 60721-3-3	- 0 °C ... + 60 °C
Enclosure of the plugged communication module	IP20	
Degree of pollution	2 to IEC/EN 61800-5-1	

4.2 Protective insulation

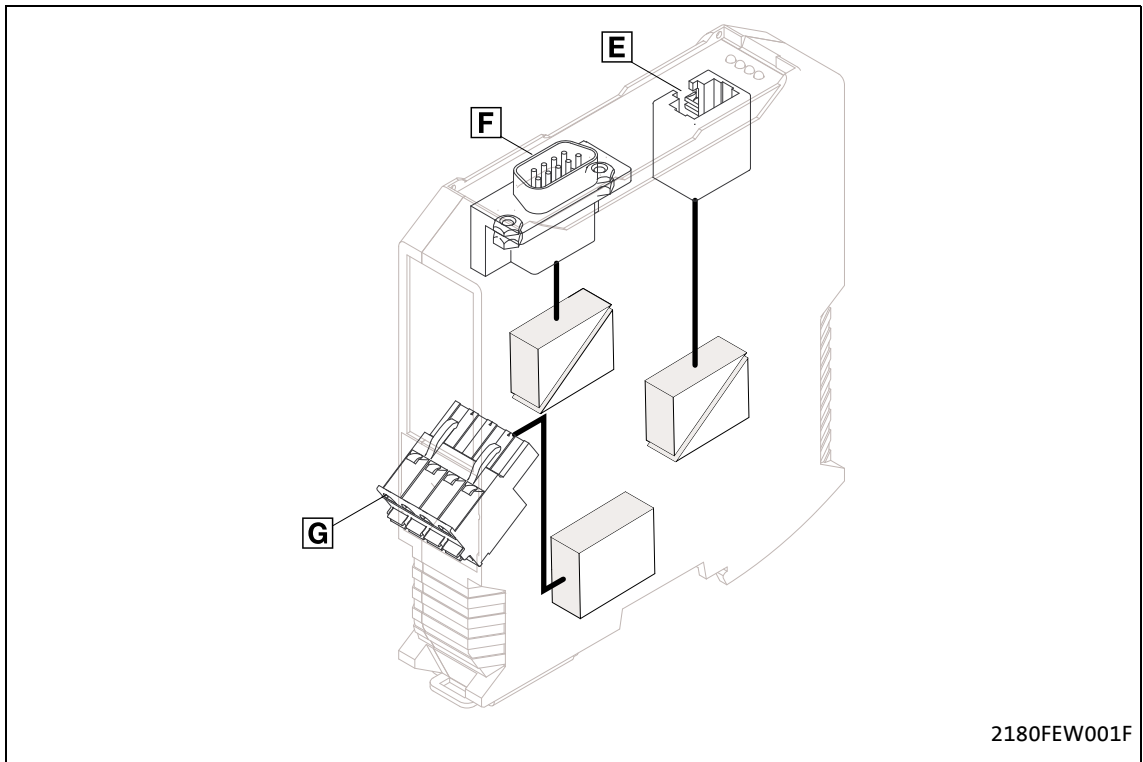

[4-1] Protective insulation according to EN 61800-5-1

Connection		Type of insulation
E	Ethernet	Functional insulation
F	CAN bus	Functional insulation
G	Voltage supply	No insulation

4 Technical data

4.3 Dimensions

4.3 Dimensions

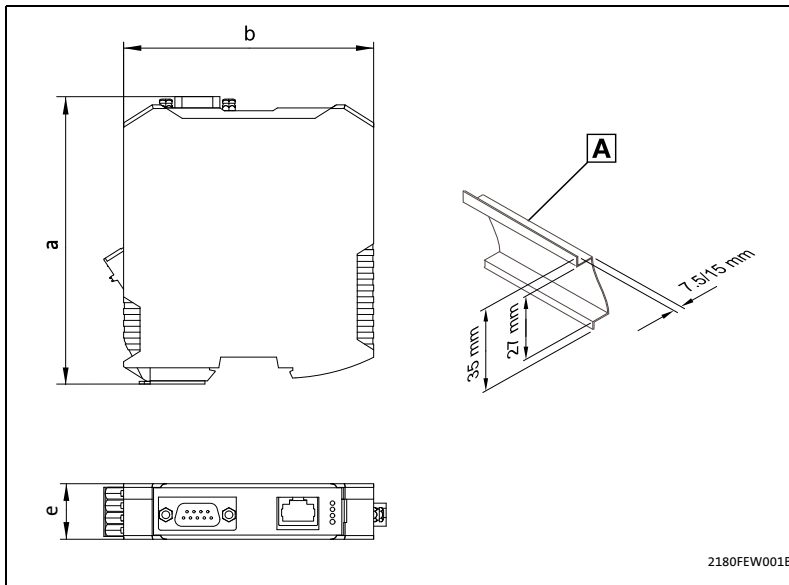

A Mounting rail

a 117 mm

b 103 mm

e 22.5 mm

[4-2] Dimensions

2180FEW001B

5 Installation



Stop!

Electrostatic discharge

Electronic components within the communication module can be damaged or destroyed by electrostatic discharge.

Possible consequences:

- The communication module is defective.
- Fieldbus communication is not possible or faulty.

Protective measures

Before touching the module, be sure that you are free of electrostatic charge.

5.1 Mechanical installation

5.1.1 Mounting

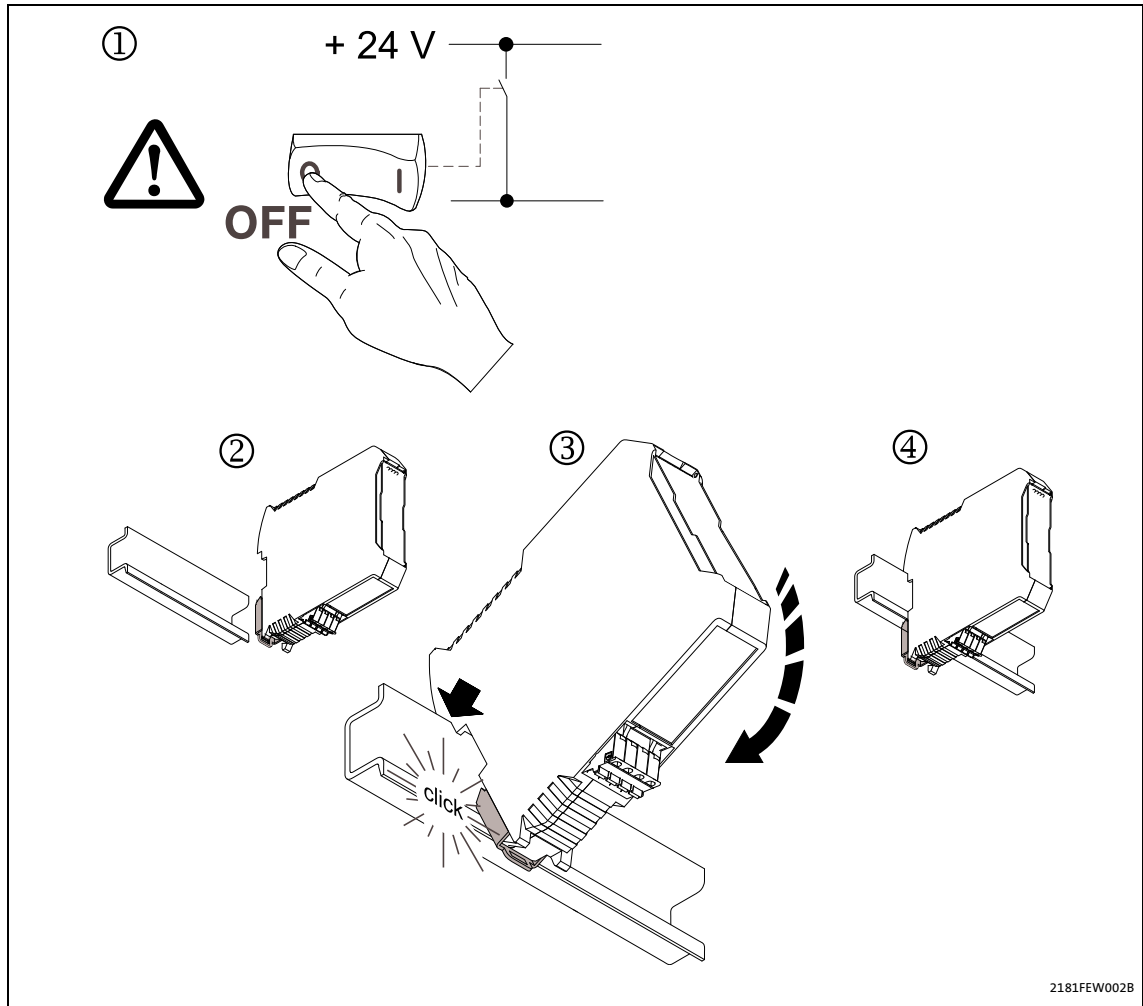

[5-1] Mounting

Switch off voltage supply (1) and attach communication module to DIN rail (2 ... 4).

5.1.2 Dismounting

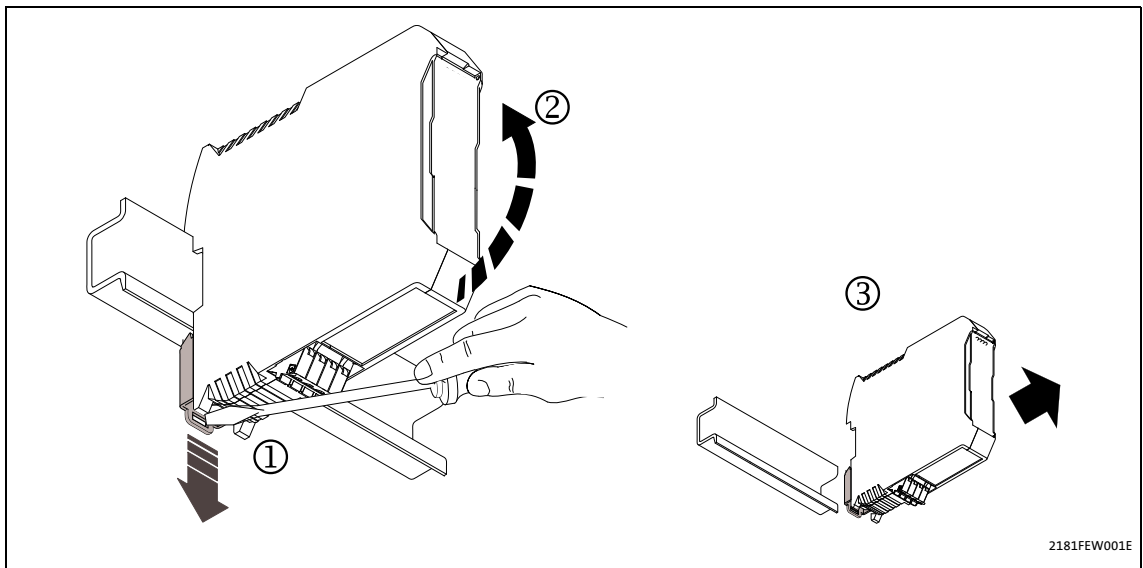

[5-2] Dismounting

Unlock communication module (1) and remove it from DIN rail (2, 3).

5.2

Electrical installation



Documentation for inverters, the control system, system/machine

Observe the notes and wiring instructions contained in this documentation.

5.2.1

Communication via Ethernet and CAN

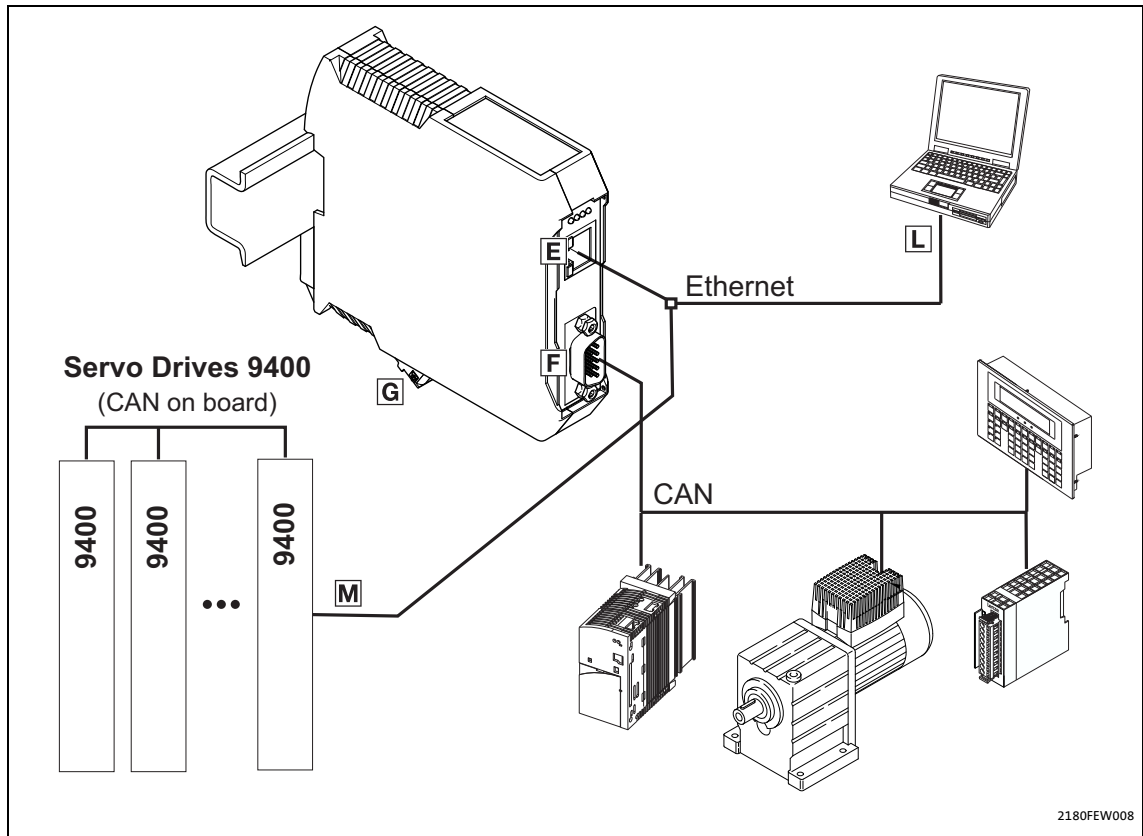

[5-3] Communication via Ethernet and CAN

Installation steps

Step		Position	Additional information
1st	Establish a connection to the CAN bus: Plug "EWZ0046" Sub-D plug (see accessories) into the communication module.	F	Connecting the CAN bus (20)
2nd	Connect the following components via Ethernet with each other: <ul style="list-style-type: none"> • Communication module • Engineering PC • Servo Drive 9400 • Other Ethernet nodes 	E L S	Connecting the Ethernet cable (25)
3.	Connect voltage supply to the plug connector.	G	Voltage supply (29)

5.2.2

Connecting the CAN bus

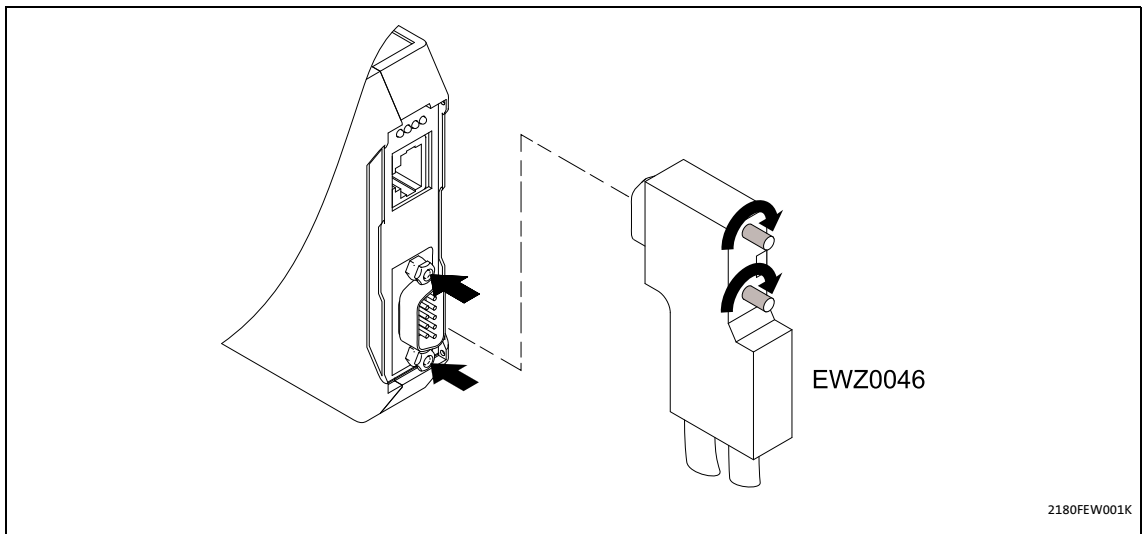

The CAN bus must be terminated with resistors ($120\ \Omega$) between CAN-low and CAN-high.

The **EWZ0046** Lenze system connector with an integrated terminating resistor complies with the DS102-1 recommendation of the CiA CAN user organisation. The system connector is not contained in the scope of supply of the communication module.

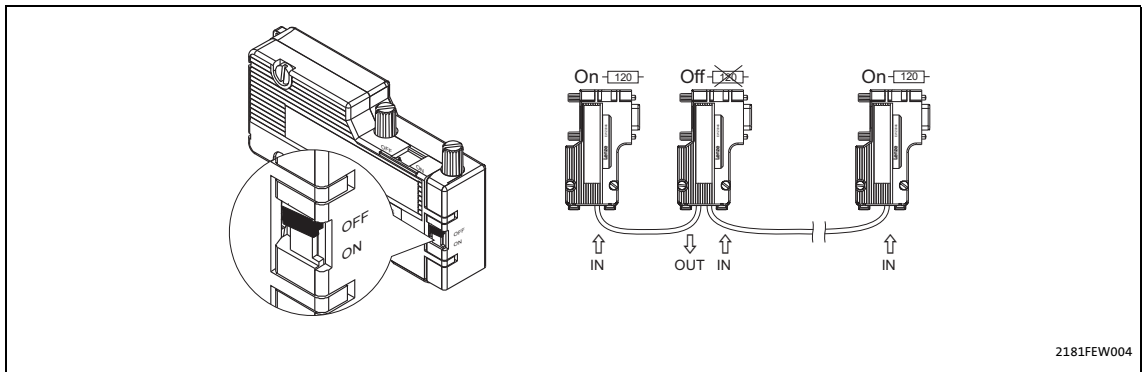

5.2.2.1 Assignment of the 9-pin Sub-D plug connector

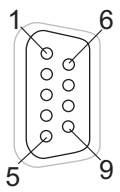
View	Pin	Assignment
	1	-
	2	CAN-LOW
	3	CAN-GND
	4	-
	5	-
	6	-
	7	CAN-HIGH
	8	-
	9	-

5.2.2.2 Specification of the CAN bus cable

We recommend the use of CAN cables complying with ISO 11898-2:

CAN cable complying with ISO 11898-2	
Cable type	Twisted in pairs with shield
Impedance	120 Ω (95 ... 140 Ω)
Cable resistance/cross-section	
Cable length \leq 300 m:	\leq 70 m Ω /m / 0.25 ... 0.34 mm ² (AWG22)
Cable length 301 ... 1000 m:	\leq 40 m Ω /m / 0.5 mm ² (AWG20)
Signal propagation delay	\leq 5 ns/m

5.2.3 Bus cable length (CAN)



Note!

- It is absolutely necessary to comply with the permissible cable lengths.
- If the total cable lengths of the CAN nodes differ for the same baud rate, the smaller value must be used to determine the max. cable length.
- Observe the reduction of the total cable length due to the signal delay of the repeater. ▶ [Checking the use of repeaters](#) (24)

5.2.3.1 Total cable length

The baud rate also determines the total cable length.

Baud rate [kbps]	Max. bus length [m]
10	8075
20	4012
50	1575
125	600
250	275
500	112
800	38
1000	12

5.2.3.2 Segment cable length

The segment cable length is determined by the cable cross-section used and by the number of nodes. Repeaters divide the total cable length into segments. If no repeaters are used, the segment cable length is identical to the total cable length.

Max. number of nodes per segment	Cable cross-section (can be interpolated)			
	0.25 mm ² (AWG 24)	0.50 mm ² (AWG 21)	0.75 mm ² (AWG 19)	1.00 mm ² (AWG 18)
2	240 m	430 m	650 m	940 m
5	230 m	420 m	640 m	920 m
10	230 m	410 m	620 m	900 m
20	210 m	390 m	580 m	850 m
32	200 m	360 m	550 m	800 m
63	170 m	310 m	470 m	690 m
100	150 m	270 m	410 m	600 m

Example: Selection help

Given	
Total cable length to be implemented	200 m
Number of nodes	63

Results	
Max. possible baud rate	250 kbit/s (derived from the table Total cable length (22))
Cable cross-section required (interpolated)	0.30 mm ² (AWG23) (derived from the table Segment cable length (23))
Cable cross-section of standard CAN cable	0.34 mm ² (AWG22) ▶ Specification of the CAN bus cable (21)

5.2.3.3 Checking the use of repeaters

Compare the values derived from tables [Total cable length \(□ 22\)](#) and [Segment cable length \(□ 23\)](#).

- If the sum of the segment cable lengths is smaller than the total cable length to be implemented, either repeaters must be used or the cable cross-section must be increased.
- If the use of repeaters reduces the max. possible total cable length so much that it is smaller than the total cable length to be implemented, the cable cross-section must be increased or fewer repeaters must be used, or the baud rate must be decreased.
- The use of a further repeater is recommended as ...
 - service interface
Advantage: trouble-free connection during bus operation is possible.
 - calibration interface
Advantage: the calibration/programming unit remains electrically isolated.

Example

Given	
Total cable length to be implemented	450 m
Number of nodes	32
Cable cross-section	0.50 mm ² (AWG 20)
Baud rate	125 kbit/s
Repeater used	Lenze repeater EMF2176IB
Reduction of the max. total cable length per repeater (EMF2176IB)	30 m

Results	
Max. possible total cable length	600 m (see table Total cable length (□ 22))
Max. segment cable length	360 m (see table Segment cable length (□ 23))
Comparison	The max. segment cable length is smaller than the total cable length to be implemented.
Conclusion	A repeater must be installed at the determined max. segment cable length of 360 m.

Results with 1 repeater	
Max. possible total cable length	570 m (Reduction of the Total cable length (□ 22) by 30 m)
Sum of the segment cable lengths	720 m
Comparison	Both the possible total cable length and the segment cable lengths are larger than the total cable length to be implemented.
Conclusion	1 repeater is sufficient to implement the total cable length of 450 m.

5.2.4 Connecting the Ethernet cable



Note!

- Decouple your Ethernet house network from the system network for Ethernet-capable Lenze devices in order to prevent EthernetCAN communication faults. Further information about this can be obtained from the "Ethernet in the industrial application" manual.
- To prevent the RJ45 socket from being damaged, insert or remove the Ethernet cable connector straight (at a right angle) into or from the socket.

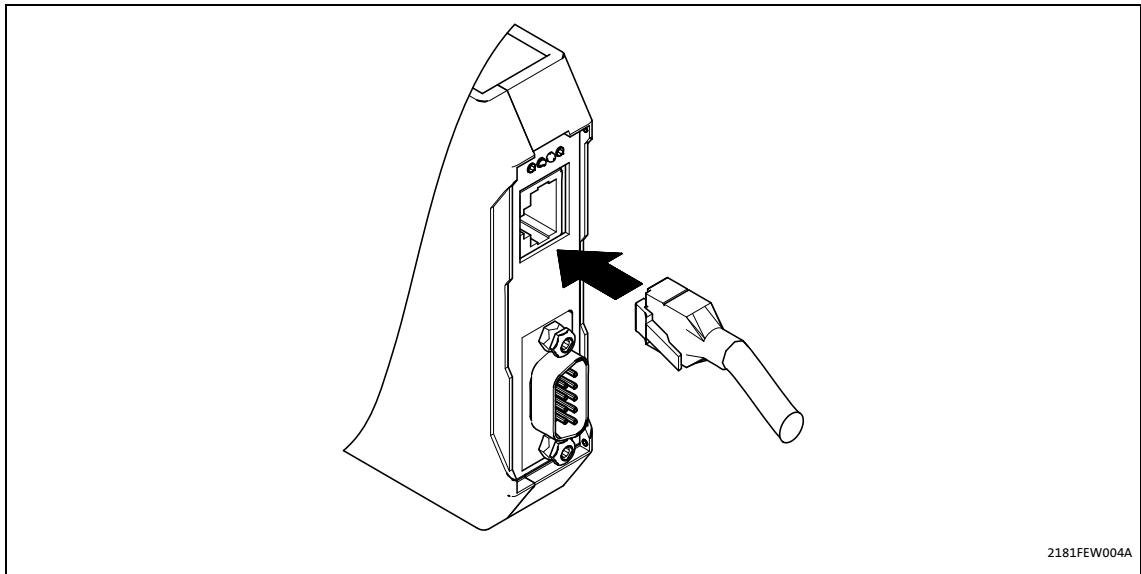

[5-4] Ethernet connection

5.2.4.1 Ethernet cable specification

Ethernet cable in compliance with IEEE 802.3	
Ethernet standard	Standard Ethernet (in accordance with IEEE 802.3), 100Base-TX (Fast Ethernet)
Cable type	S/FTP (Screened Foiled Twisted Pair), ISO/IEC 11801 or EN 50173, CAT 5e
Damping	23.2 dB (for 100 MHz and 100 m each)
Crosstalk damping	24 dB (for 100 MHz and 100 m each)
Return loss	10 dB (100 m each)
Surge impedance	100 Ω

Structure of the Ethernet cable

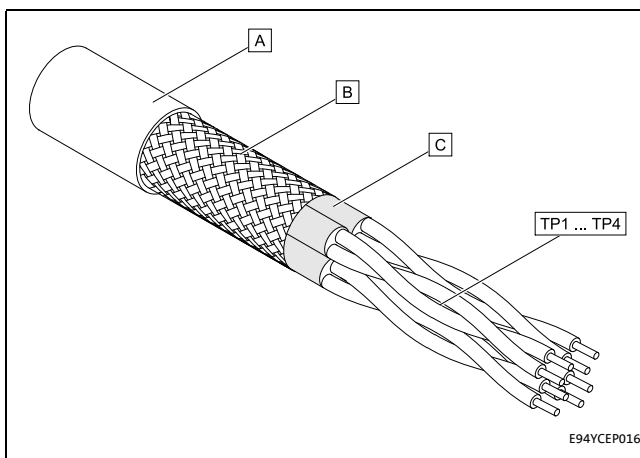

A Cable insulation

B Braid

C Foil shielding

TP1 Twisted core pairs 1 ... 4

... [▶ Colour code of the Ethernet cable](#)

TP4 [\(27\)](#)

[5-5] Structure of the Ethernet cable (S/FTP, CAT 5e)

Colour code of the Ethernet cable



Note!

Wiring and colour code are standardised in EIA/TIA 568A/568B.

In accordance with the industrial standard, the use of 4-pin Ethernet cables is permissible. The cable type only connects the assigned pins 1, 2, 3 and 6 to one another.

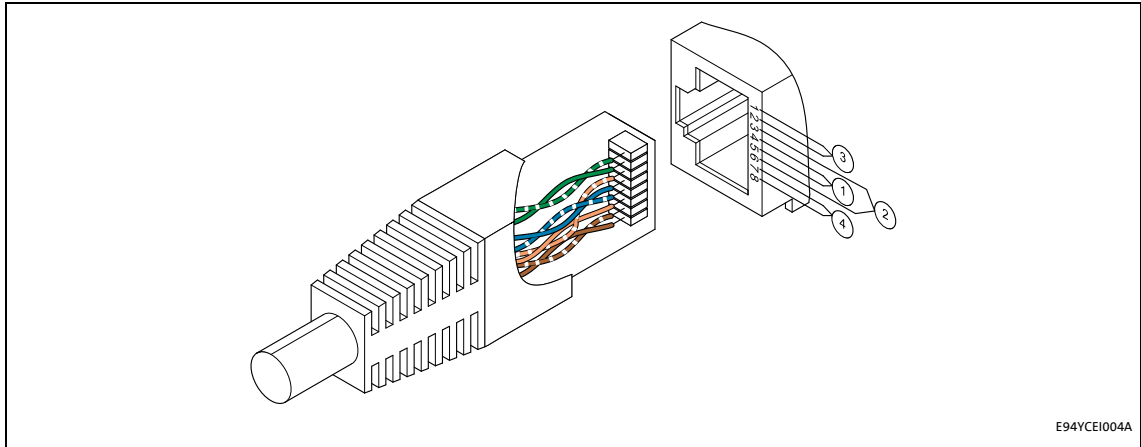

[5-6] Ethernet plug in accordance with EIA/TIA 568A/568B

Pair	Pin	Signal	EIA/TIA 568A	EIA/TIA 568B
3	1	Tx +	white / green	white / orange
	2	Tx -	green	orange
2	3	Rx +	white / orange	white / green
1	4		blue	blue
	5		white / blue	blue / white
2	6	Rx -	orange	green
4	7		white / brown	white / brown
	8		brown	brown

5.2.4.2 Pin assignment and use of the Ethernet cable

100BaseTX - CrossOver Cable	100BaseTX - Standard Patch Cable
<p> Tx+ 1 ← → 1 Tx+ Tx- 2 ← → 2 Tx- Rx+ 3 ← → 3 Rx+ 4 ← → 4 5 ← → 5 Rx- 6 ← → 6 Rx- 7 ← → 7 8 ← → 8 </p>	<p> Tx+ 1 ← → 1 Tx+ Tx- 2 ← → 2 Tx- Rx+ 3 ← → 3 Rx+ 4 ← → 4 5 ← → 5 Rx- 6 ← → 6 Rx- 7 ← → 7 8 ← → 8 </p>
<p>The "100BaseTX - CrossOver Cable" is used for direct coupling of the Engineering PC with the communication module.</p>	<p>The "100BaseTX - Standard Patch Cable" is used in conjunction with hubs and switches.</p>

5.2.5 Voltage supply

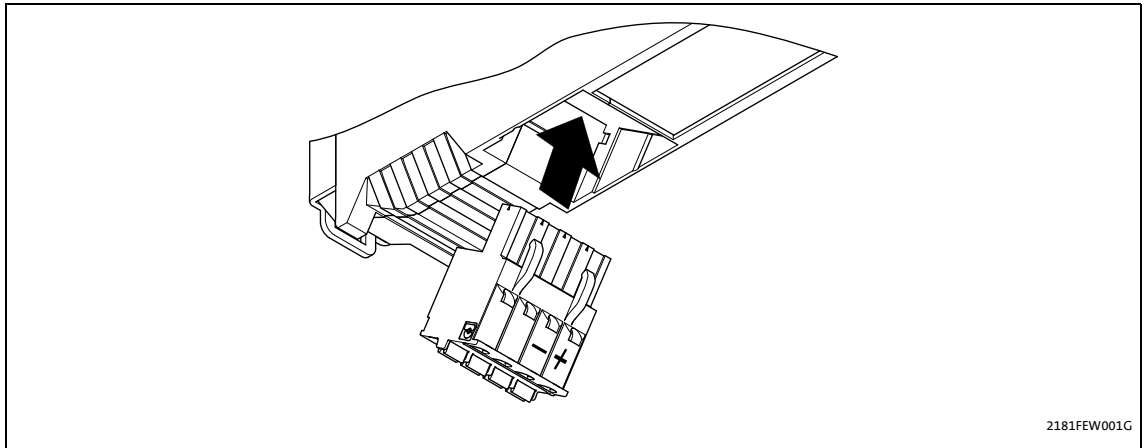

[5-7] Communication via the diagnostic interface (only for Servo Drives 9400)

Handling of pluggable terminal strips



Stop!

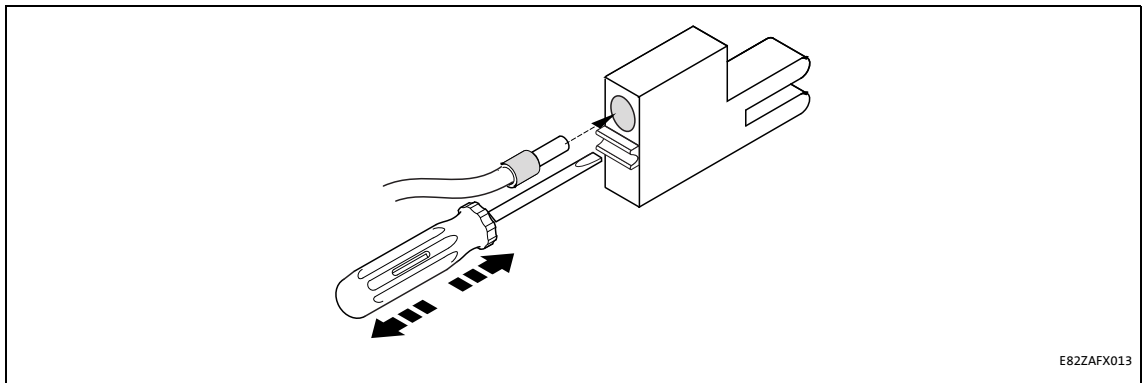

Observe the following to prevent any damage to the plug-on terminal strips and contacts:

- Wire the plug-on terminal strips first, then plug them on.
- Plug-on terminal strips that are not assigned must also be plugged on.

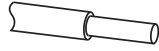
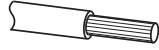
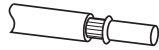

[5-8] Use of pluggable terminal strip with spring connection

Terminal data

Range	Values	
Electrical connection	Plug connector with spring connection	
Possible connections	rigid:	
		2.5 mm ² (AWG 12)
	flexible:	
		without wire end ferrule 2.5 mm ² (AWG 12)
		with wire end ferrule, without plastic sleeve 2.5 mm ² (AWG 12)
	with wire end ferrule, with plastic sleeve 2.5 mm ² (AWG 12)	
Bare end	10 mm	

6 Commissioning

6.1 Commissioning with the Lenze "System bus configurator"

6 Commissioning

6.1 Commissioning with the Lenze "System bus configurator"

Via the "System bus configurator", the EMF2180IB communication module is configured for communication with the fieldbus nodes and the Lenze Engineering tools.

The "System bus configurator" is part of the following Lenze Engineering tools:

- »EASY Starter«
- »Application Loader«
- »Engineer«
- »Drive Server«, from version 1.1 onwards
- »Drive PLC Developer Studio« (DDS), from version 2.2 onwards
- »Global Drive Control« (GDC), from version 4.7 onwards
- »Global Drive Loader« (GDL), from version 2.2 onwards



Note!

Some of the Engineering tools mentioned offer alternative communication paths for CAN. In this case, always select the "OPC" communication path.



Tip!

We recommend always using the most recent version of the Lenze Engineering tools.

Current software updates for the Engineering tools and information about the system requirements can be found in the "Download" area at:

www.lenze.com

6.1.1 Installing/updating software



How to install or update the Lenze Engineering tools:

1. Download the corresponding file from the Download area of the Lenze homepage to your Engineering PC.
2. Start the installation program by double-clicking the file downloaded.
3. Follow the further instructions of the installation program.

After having carried out the installation successfully, you can open the "System bus configurator" via the **MS Windows® start menu** under:

All Programs → Lenze → Communication → System bus configurator

6.1.2 Configuring the communication module

Before communication with the communication module can be established, you have to carry out settings for the following parameters:

- CAN parameters

The CAN parameters are saved in the communication module and contain specific data for the CAN bus such as the baud rate, parameter data channel, or time-out.

- Parameters for access to the communication module

The communication module is an Ethernet node. Each Ethernet node has 2 addresses: a MAC address and an IP address.

The MAC address serves to unambiguously identify a device worldwide. Observe the MAC address entry on the nameplate of the communication module. The MAC address is hard-coded in the device and cannot be changed. If an Ethernet connection to the communication module has already been established, the MAC address can be read out online.

The IP address is a logical address which must be adapted to the corresponding Ethernet network.



How to configure the communication module:

1. Open the "System bus configurator" via the **MS Windows®** start menu under:
All Programs → Lenze → Communication → System bus configurator
2. Click the **Add** button and select the "EMF2180IB" communication module from the list.
3. Click the **Settings** tab.
4. Enter the CAN parameters.

The following function is available from **version 1.7 onwards!**

Via code [C1216](#) or the web interface, you can assign an alphanumeric name to the communication module:

CAN/CANopen parameter		
C350	CANopen node ID:	62
C351	Baudrate Kbit/s:	500
C1200	Parameter channel:	1
C1201	SDO timeout in ms:	1500
C1202	Busscan timeout in ms:	1000
C1227	Busscan delay in ms:	15
C1203	Retries:	1
C1219	Device detection active:	1
C1217	Device detection cycle time in ms:	5000
C1215	Baudrate verification timeout in ms:	1000
C1216	User specific device name:	EthernetCAN2180IB (Valid characters: 'A-Z', 'a-z', '0-9', '.', '-')

2180FEW016

-
5. Enter the MAC address of the nameplate or identify it online.
 6. Enter the desired IP address and transfer it to the communication module online.
Afterwards an automatic reset is carried out by the communication module, which may take some seconds (observe LEDs).
 7. When the communication module is ready for operation again, change to the **General** tab.
 8. Click the **Diagnostics** tab.
An attempt is made to establish a connection to the communication module. First, a comparison is made, checking whether the CAN parameters configured are identical to those in the device. If this is not the case, an adjustment is carried out.
 9. Then search the CAN bus for nodes connected.
 10. Confirm the confirmation prompt with **Yes**, or select **No** to abort the diagnostics process.

6.1.3 After completing the configuration

Communication with Lenze Engineering tools

When the configuration of the communication module has been completed successfully, the Lenze Engineering tools can communicate via the communication module. The Lenze Engineering tools only carry out the selection of the bus system to be used.

All system bus-specific settings as well as the selection of the communication module are exclusively carried out via the "System bus configurator".



Note!

For some older program versions of the Lenze Engineering tools, settings for "Interrupt" and "I/O address" can still be made, which, for the EMF2180IB communication module, are irrelevant.

Communication with nodes

If the communication module can communicate successfully with the corresponding nodes, the CAN node addresses of the nodes found are listed in the **Device status** field.

The communication module itself answers with its CAN node address or with "0" if it doesn't have a CAN node address (depending on the setting in [C0350](#)). The data frames for communication with the communication module itself are not visible on the CAN bus.

Communication failed

If there is no communication with the nodes, a corresponding error message is output.

6.2 Commissioning with the web server

Commissioning via the integrated web server is an alternative to commissioning with the "System bus configurator".

The integrated web server makes it possible to configure the communication module by means of a simple web browser.

The following function is available **from version 1.7 onwards!**

When the DHCP function is activated, the DHCP server automatically assigns an IP address to the communication module.

If an invalid combination of IP address and subnet mask is detected, an error message is output via the web page:

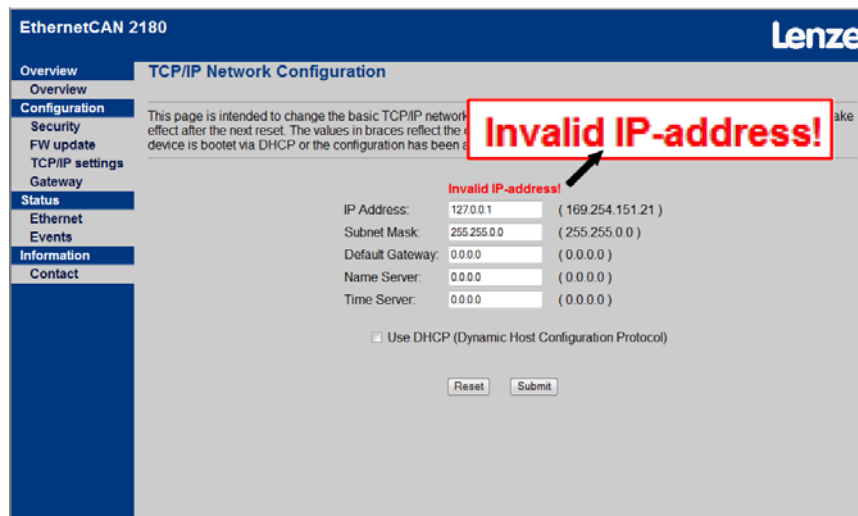

2180FEW019

In this case, the two values (IP address, subnet mask) will not be saved in the EEPROM of the communication module.

The gateway IP is only valid if it is inside the user's own network (exception: gateway IP '0.0.0.0').

The following function only applies to version <1.7!

Prerequisites for commissioning via web server:

- The IP address of the communication module must have been assigned by the "System bus configurator" before.
- The IP address must be within the range that can be addressed by the Engineering PC connected.

If one of the preconditions is not met, the IP address has to be changed using the "System bus configurator":

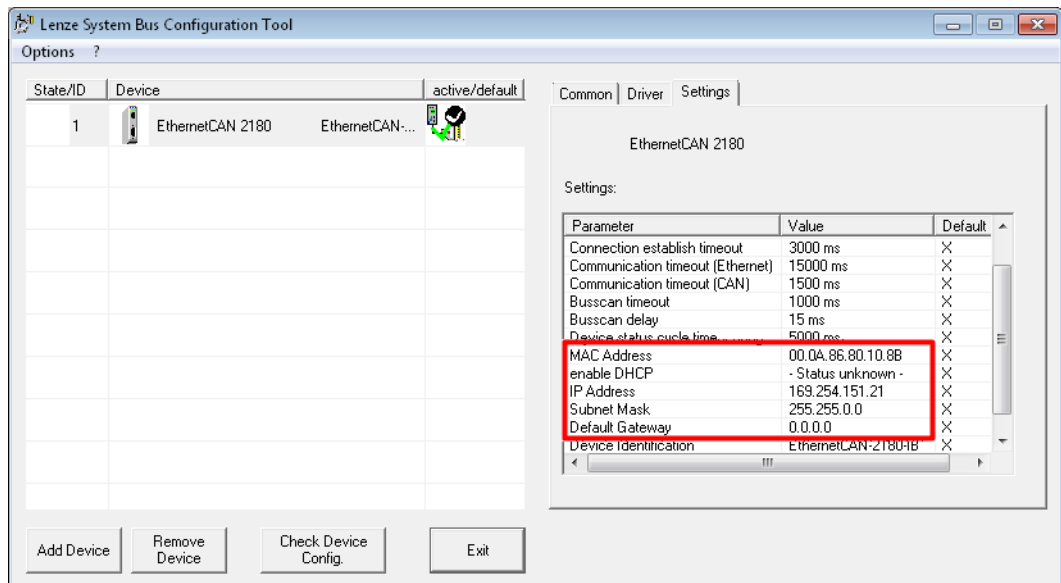

2180FEW017

6.2.1 Assigning a fixed IP address



Note!

The Lenze standard setting of the IP address is '0.0.0.0'. With this (invalid) IP address, the communication module at the start automatically finds its own IP address in the range of '169.254.xxx.xxx' on the basis of the standardised APIPA process.

Start your web browser and then enter the communication module's IP address that is known to you as URL (instead of "xxx.xxx.xxx.xxx"):

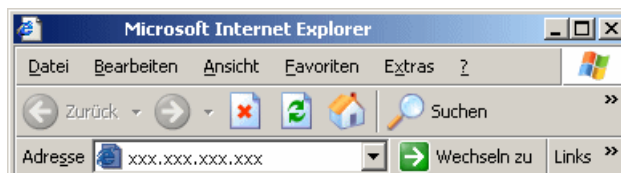

2180FEW010

The web interface of the communication module will appear. Here you can carry out all further settings.

EthernetCAN 2180
Lenze

Overview

Overview

Configuration

Security

FW update

TCP/IP settings

Gateway

Status

Ethernet

Events

Information

Contact

Gateway details

Order number	Serial number	Firmware revision	Hardware revision
EMF 2180B	0000001	0.8	0.A

Gateway status

Bus Status	Error status	Baudrate	Client connections
BUS-ON	OK	500 KBits/s	0

2180FEW011

6.2.2 Assigning a dynamic IP address

By corresponding configuration, the communication module can also dynamically obtain the IP address by the DHCP server.

For this, activate the "Use DHCP" checkbox under the TCP/IP settings:

The screenshot shows the web interface for the EthernetCAN 2180 module. The page title is "EthernetCAN 2180" and the Lenze logo is in the top right. The navigation menu on the left includes Overview, Configuration, Security, FW update, TCP/IP settings (highlighted), Gateway, Status, Ethernet, Events, Information, and Contact. The main content area is titled "TCP/IP Network Configuration" and contains the following text: "This page is intended to change the basic TCP/IP network parameter. They are stored in non volatile RAM and changes will take effect after the next reset. The values in braces reflect the current settings. These may differ from the configured values if the device is bootet via DHCP or the configuration has been already changed without resetting the device." Below this text are five input fields for network parameters, each with a current value and a default value in parentheses: IP Address (172.31.201.209 / 172.31.201.209), Subnet Mask (255.255.255.0 / 255.255.255.0), Default Gateway (0.0.0.0 / 0.0.0.0), Name Server (0.0.0.0 / 0.0.0.0), and Time Server (0.0.0.0 / 0.0.0.0). At the bottom, there is a checkbox labeled "Use DHCP (Dynamic Host Configuration Protocol)" which is currently unchecked and highlighted with a red box.

2180FEW013



Note!

Since the procedure for the dynamically assigned IP address is not found in industrial environments very often, its use is not recommended.



Ethernet communication manual

Here you'll find more information about the configuration of an Ethernet network.

The following function is available from version 1.7 onwards!

You can activate DHCP in the »Engineer« via code [C1228](#):

ID	Name	Value	U...
1223	User Name	Lenze	
1224	Default Gateway Preset 1	0	
1224	Default Gateway Preset 2	0	
1224	Default Gateway Preset 3	0	
1224	Default Gateway Preset 4	0	
1227	CAN Bus Scan Delay	15	ms
1228	DHCP Activation	0: Not Active	
1229	Activation of IP Settings, Device Reset	0: Not Active	
1230	DIS: IP Address 1 - active	1: Active	
1230	DIS: IP Address 2 - active	254	
1230	DIS: IP Address 3 - active	151	
1230	DIS: IP Address 4 - active	21	

C01228:000 DHCP Activation
 PC value: Not Active
 Device value: Not Active
 0 [Raw value decimal]
 0x0 [Raw value hexadecimal]
 Default setting: Not Active

2180FEW018

So far, this has only been possible via a checkbox on the "TCP/IP Settings" page of the web interface. A static IP configuration that has already been configured is maintained after the activation of DHCP and subsequent mains switching or reset, the static IP configuration is still valid.

6.2.3 Entering a user name and password

All settings that can be carried out under "Configuration" are protected by a combination of a user name and a password. The Lenze standard setting is:

- User name: Lenze
- Password: Lenze

The user name and password can be changed as often as desired. The entries are case-sensitive.

Via the **Submit** button, the data that have been altered are written to the EEPROM of the communication module. They are only active after the next restart.

The screenshot shows the web interface for the EthernetCAN 2180. The top header is blue with "EthernetCAN 2180" on the left and the "Lenze" logo on the right. A left-hand navigation menu is visible with categories: Overview, Configuration, Status, and Information. Under Configuration, the sub-items are Security, FW update, TCP/IP settings, and Gateway. Under Status, the sub-items are Ethernet and Events. Under Information, the sub-item is Contact. The main content area is titled "Gateway access" and contains a text box with the instruction: "This page is intended to configure a user name and a password to restrict the access to gateway configuration parameter." Below this, there are two input fields: "User Name:" with the value "Lenze" and "(Max. 11 characters)", and "Password:" with masked characters "•••••" and "(Max. 11 characters)". At the bottom of the form are two buttons: "Reset" and "Submit".

2180FEW012

6.2.4 Firmware update ("FW update")



Note!

This page is only used for Lenze-internal purposes and cannot be accessed freely.

6.2.5 Displaying Ethernet states

These states are displayed:

- Current transfer rate (10/100 Mbps)
- Transmission mode (half/full duplex)
- MAC ID of the EMF2180IB communication module
- Static parameters of the Ethernet connection

EthernetCAN 2180

Overview

Overview

Configuration

Security

FW update

TCP/IP settings

Gateway

Status

Ethernet

Events

Information

Contact

Ethernet parameter

MAC Address	Speed	Communication
00-0a-86-80-00-01	100 MBit/s	Half Duplex

Ethernet statistics

Receive Statistics		Transmit Statistics		Misc Errors	
Packets	303	Packets	191	Link down	0
Multicast Packets	72	Multicast Packets	0	Receiver resets	0
Packets Passed	303	Jumbo packets	0	Transmitter resets	0
Multicast Passed	72	Late Collisions	0		
Skipped Packets	0	Exces. Deferrals	0		
Overrun Errors	0	Exces. Collisions	0		
Align Errors	0	Buffer Underrun	0		
CRC Errors	0				
Coding Errors	0				
Buffer overflow	0				

2180FEW014

6.2.6 Displaying alarms and events

After the communication module has been started, alarms and events are recorded and displayed in a list.

Events are classified by severity into:

- Error
- Warning
- Information

The list also contains the time when the alarm or the event occurred.

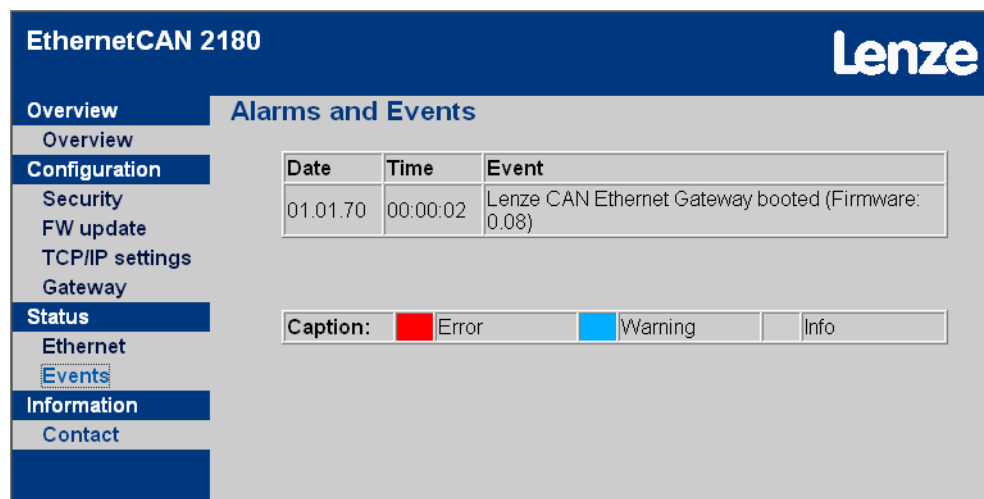

EthernetCAN 2180 **Lenze**

Overview **Alarms and Events**

Overview

Configuration

Security

FW update

TCP/IP settings

Gateway

Status

Ethernet

Events

Information

Contact

Date	Time	Event
01.01.70	00:00:02	Lenze CAN Ethernet Gateway booted (Firmware: 0.08)

Caption: ■ Error ■ Warning ■ Info

2180FEW015



Note!

The list is deleted every time the communication module is restarted.

Date and time are only correct if a "time server" is configured. Without configuration of the "time server", the computation of time always starts with the restart of the communication module on 01.01.1970 at 0:00 h.

6.3

Before initial switch-on

**Stop!**

Before switching on the mains voltage, check ...

- the entire wiring for completeness, short circuit and earth fault:
- whether the bus system is terminated by means of a bus terminating resistor at the first and last physical bus station.
▶ [Connecting the CAN bus](#) (□ 20)

Automatic address allocation and detection of the baud rate

The EMF2180IB communication module is provided with the following functions:

- Automatic address allocation
- Automatic detection of the baud rate

These functions are used to prevent failures due to an incorrectly set node address and baud rate.

**Note!**

In the Lenze standard setting, these functions are not activated.

For this, observe the information relating to codes ...

- [C0350](#) (CAN node address)
- [C0351](#) (CAN baud rate)

6 Commissioning

6.4 Initial switch-on

6.4 Initial switch-on

6.4.1 Signalling sequence of the LEDs

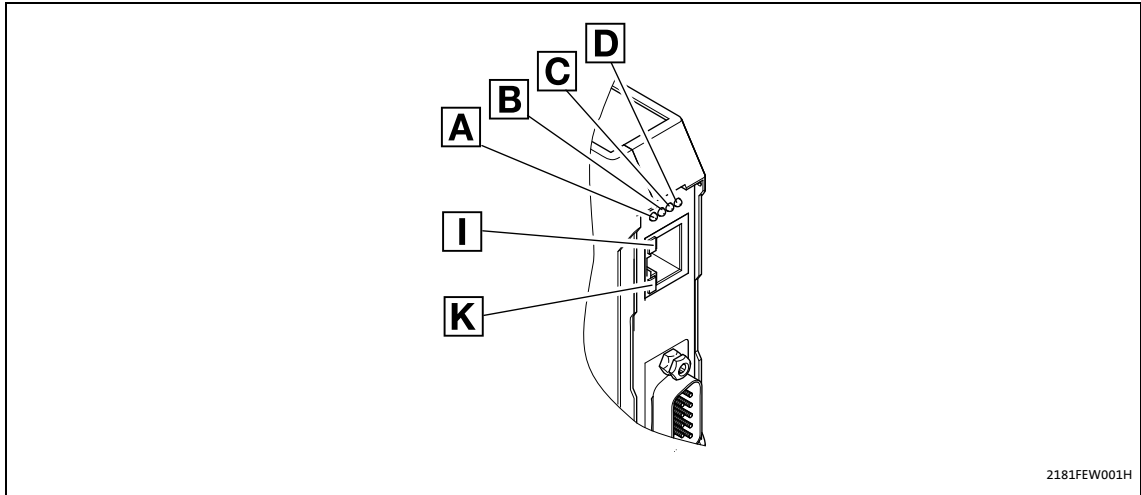

[6-1] LEDs on the front of the communication module

Signalling sequence after switch-on:

1. Initialisation phase of peripherals starts:
 - LED **D** (voltage supply, green) is lit.
2. After the CAN controller initialisation:
 - LED **C** (RUN-LED, green) is blinking.
3. Ethernet connection is established:
 - LED **I** is lit.
 - LED **A** shows the baud rate of the Ethernet connection (10 Mbps or 100Mbps).
 - When LED **A** is blinking, the communication module is currently determining the IP address. Communication via Ethernet is only possible when this process has been completed.

The device is ready for operation now.



6 Commissioning

6.4 Initial switch-on

6.4.2 LED signalling in compliance with DR303-3

Connection status to the CAN bus with the following signalling:

LEDs	Description
Off	Connection to the master is available.
Green	CANopen status ("Z")
Red	CANopen error ("F")

Status display (LED)	Explanation
Constantly red	F: Bus-off 
Flicker	Automatic baud rate detection is active. 
Blinking green every 0.2 s	Z: Pre-operational, F: No errors 
Blinking green every 0.2 s 1 x red blinking, 1 s OFF	Z: Pre-operational, F: Warning limit reached 
Green blinking every 0.2 s 2 x red blinking, 1 s OFF	Z: Pre-operational, F: Node guarding event 
Constantly green	Z: Operational, F: No errors 
Constantly green 1 x red blinking, 1 s OFF	Z: Operational, error: Warning limit reached 
Constantly green 2 x red blinking, 1 s OFF	Z: Operational, F: Node guarding event 
Constantly green 3 x red blinking, 1 s off	Z: Operational, F: Sync message error 
Green blinking every second	Z: Stopped, F: No errors 
Green blinking every second 1 x red blinking, 1 s OFF	Z: Stopped, F: Warning limit reached 
Green blinking every second 2 x red blinking, 1 s OFF	Z: Stopped, F: Node guarding event 

7 Data transfer

The master (e.g. a PLC) and inverter communicate with each other by exchanging data frames via the fieldbus. The user data area of the data frame either contains network management data, parameter data, or process data.

Different communication channels are assigned to parameter and process data in the inverter.

Parameters are for instance operating parameters, motor data, or diagnostic information, which are stored under a code in the Lenze inverters.

Normally, the transfer of parameters is not as time-critical as the transfer of process data.

7.1 Access to the inverter codes



Documentation for the inverter

Here you can find some detailed information on the codes and value ranges.

Via the communication module, a higher-level master (e.g. a PLC) can change the properties and the response of each inverter integrated in the network.

In Lenze inverters, parameters to be changed are listed under codes.

Inverter codes are addressed via indexes when accessing the code through the communication module.

The indexes for Lenze code numbers are between 16576 (0x40C0) and 24575 (0x5FFF).

Indexing of codes using the example of code C0001 (operating mode)

Decimal	Hexadecimal
Index = 24575 - Lenze code number	Index = 0x5FFF - Lenze code number [hex]
Index = 24575 - 1 = 24574	Index = 0x5FFF - 0x1 = 0x5FFE

7.2 Data transfer via CAN

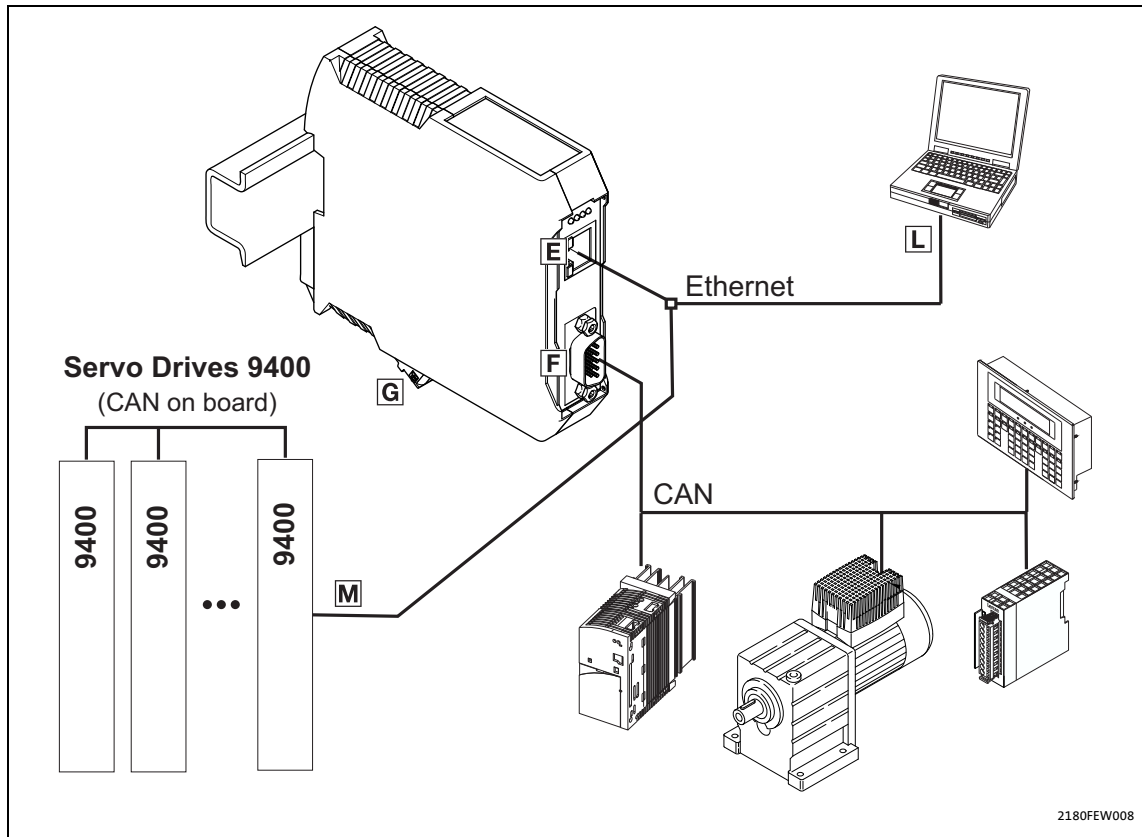

[7-1] Parameter data transfer via CAN

Parameter data are transmitted via the CAN bus as so-called "Service Data Objects (SDOs) and are acknowledged by the receiver. The SDO enables read and write access to the object directory.

Indexes (e.g. [I-1000](#)) provide for access to parameters and functions of the device, which are stored in the object directory. In order to be able to transfer SDOs, the information contained in the user data must comply with the CAN-SDO protocol.



CAN/CANopen communication manual

Here you'll find some detailed information relating to the CAN frame structure.

CANopen parameter channels

The communication module is provided with two parameter data channels.

In the Lenze standard setting, both channels are activated.



Note!

Compatibility with CANopen

Switch off the second parameter data channel via code **C1200** in order to establish compatibility with CANopen.

7.3 Data transfer via Ethernet

The Engineering PC and the communication module communicate via a proprietary protocol which is based on TCP/IP. The port number '22080' is used for the communication module.

The port number may have to be cleared if a firewall or something similar is used.

Port '3677' is used to search for fieldbus nodes.

Port '80' is required to operate the web server.

**Tip!**

The search via Ethernet is only possible within a network. The frames are not transmitted via routers.

**Ethernet communication manual**

Here you'll find some detailed information relating to the Ethernet data frame structure.

8 Diagnostics

8.1 Error: Cause and remedy

8 Diagnostics



8.1 Error: Cause and remedy









Diagnostics	Possible error cause	Remedy
Power LED (P) is not on.	The device is not switched on.	Check external voltage supply.
Error LED (E) is on or blinking.	CAN bus error	Check CAN wiring.
Link LED is not on.	Ethernet wiring error	Check Ethernet wiring.

8.2 LED status displays for the communication module and for CAN communication

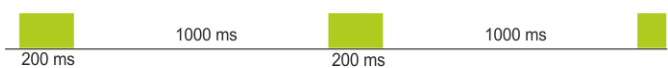

[8-1] LED status displays for the communication module and for CAN communication

LED	Colour	Status	Description
B	Yellow	off	Ethernet baud rate: 10 Mbps
		on	 Ethernet baud rate: 100 Mbps
		Blinking	 The IP address is not assigned yet; it is currently being identified.

LED	Colour	Status	Description
E (Error)	Red	off	No error; the device is ready for operation.
		on	 "Bus off" state The CAN controller is in the "Bus off" state. "Diagnostic interface" operating mode In this operating mode, the LED is lit if no device is connected.
		blinking once (single flash)	 Warning limit is reached At least one of the error counters of the CAN controller has reached or exceeded the warning level (too many error frames).
		blinking twice (double flash)	 Error control event A guard event (NMT slave or NMT master) or heartbeat event (heartbeat consumer) has occurred.
		blinking 3 times (triple flash)	 SYNC error The sync message has not been received within the time configured for the time monitoring of the communication cycle.
		flickering	 AutoBaud/LLS The automatic detection of the baud rate or LSS services is/are executed. (The LEDs E and R are flickering alternately red/green.)
R (Run)	Green	off	No communication
		on	 "Operational" state The communication module is in the "Operational" state.
		blinking	 "Pre-operational" state The communication module is in the "Pre-operational" state.
		blinking once (single flash)	 "Stopped" state The communication module is in the "Stopped" state.
		flickering	 AutoBaud/LLS The automatic detection of the baud rate or LSS services is/are executed. (The LEDs E and R are flickering alternately red/green.)

8

Diagnostics

8.3

LED status displays for Ethernet communication



LED	Colour	Status	Description
P (Power)	Green	off	The communication module is <u>not</u> supplied with voltage.
		on	 The communication module is supplied with voltage.

8.3

LED status displays for Ethernet communication



[8-2] LED status displays for Ethernet communication

LED	Colour	Status	Description
A (Link)	Green	off	No connection to Ethernet
		on	 Ethernet connection is available.
B (Activity)	Green	off	No data transfer
		on or flickering	  Data are transmitted or received.

9 Parameter reference

9 Parameter reference

This chapter lists all parameters of the communication module in numerically ascending order.

C0002

Parameter Name: C0002 Load default setting		Data type: INTEGER_32 Index: 24573 = 0x5FFD
C0002 shows the status of the device command executed last. C0150 can be used to enquire the current status of the device control.		
Selection list (Lenze setting printed in bold)		Info
0	Load Def.	Load Lenze standard setting • Only possible with controller inhibit and stopped user program.
1	Load PS	Load parameter set • The parameter set stored in the memory module is loaded. • Only possible with controller inhibit and stopped user program.
<input checked="" type="checkbox"/> Read access <input checked="" type="checkbox"/> Write access <input type="checkbox"/> CINH <input type="checkbox"/> PLC STOP <input checked="" type="checkbox"/> No transfer		

C0093

Parameter Name: C0093 Device type		Data type: INTEGER_32 Index: 24482 = 0x5FA2
The display for the EMF2180IB communication module is "2180 0000".		
Display range (min. value unit max. value)		
-214748		214748
<input checked="" type="checkbox"/> Read access <input type="checkbox"/> Write access <input type="checkbox"/> CINH <input type="checkbox"/> PLC STOP <input type="checkbox"/> No transfer Scaling factor: 10000		

C0099

Parameter Name: C0099 Software version		Data type: INTEGER_32 Index: 24476 = 0x5F9C
Display "x.y" (x: major version, y: index)		
Display range (min. value unit max. value)		
0.0		100.0
<input checked="" type="checkbox"/> Read access <input type="checkbox"/> Write access <input type="checkbox"/> CINH <input type="checkbox"/> PLC STOP <input type="checkbox"/> No transfer Scaling factor: 10000		

9 Parameter reference

C0150

Parameter Name: C0150 Status word		Data type: UNSIGNED_16 Index: 24425 = 0x5F69
The binary interpretation of the displayed decimal value reflects the bit statuses of the status word: <ul style="list-style-type: none"> • Bit 0: Ready for operation • Bit 1: Dial-up connection is available • Bit 2: Internal error 		
Value is bit-coded:		
Bit 0	Ready for operation	
Bit 1	Reserved	
...	...	
Bit 15	Reserved	
<input checked="" type="checkbox"/> Read access <input type="checkbox"/> Write access <input type="checkbox"/> CINH <input type="checkbox"/> PLC-STOP <input type="checkbox"/> No transfer		

C0200

Parameter Name: C0200 Software ID		Data type: VISIBLE_STRING Index: 24375 = 0x5F37
During initialisation, the manufacturer's product code is used to determine which device is connected as node. The display for the EMF2180IB communication module is "33S2180F_10000".		
<input checked="" type="checkbox"/> Read access <input type="checkbox"/> Write access <input type="checkbox"/> CINH <input type="checkbox"/> PLC-STOP <input type="checkbox"/> No transfer		

C0202

Parameter Name: C0202 Software ID (octet)		Data type: INTEGER_32 Index: 24373 = 0x5F35
In subcodes 1 ... 4, the corresponding octet of the manufacturer's product code is shown.		
Display range (min. value unit max. value)		
-2147483647		2147483647
Subcodes		Info
C0202/1		1st octet
C0202/2		2nd octet
C0202/3		3rd octet
C0202/4		4th octet
<input checked="" type="checkbox"/> Read access <input type="checkbox"/> Write access <input type="checkbox"/> CINH <input type="checkbox"/> PLC-STOP <input type="checkbox"/> No transfer		

9 Parameter reference

C0350

Parameter Name: C0350 CAN node address		Data type: INTEGER_32 Index: 24225 = 0x5EA1	
<p>The node address can be set via the CAN bus using the code C0350.</p> <p>If zero is used as address, the communication module does not have a node address of its own. It can then not be addressed from the CAN bus (no parameter setting, node guarding, etc.), but only serves as a dial-in option for reading parameters via the CAN bus.</p> <p>If the communication module is to have an address, after determination of the baud rate, check whether this address is still free. Then an attempt is made to read the implemented CANopen object -1000. If this address is already assigned to another node, another free address is selected automatically.</p> <p>Note: Node addresses in the range of 64 ... 127 can only be assigned if code C1200 is set to the value "0" (CANopen conformity)</p> <p>Changes that are made to the settings will be accepted after ...</p> <ul style="list-style-type: none"> • reconnection to the mains; • a "Reset node" or "Reset communication" via the bus system; • a "Reset node" via code C0358. 			
Setting range (min. value unit max. value)		Lenze setting	
0		127 63	
<input checked="" type="checkbox"/> Read access <input checked="" type="checkbox"/> Write access <input type="checkbox"/> CINH <input type="checkbox"/> PLC STOP <input type="checkbox"/> No transfer			

C0351

Parameter Name: C0351 CAN baud rate		Data type: INTEGER_32 Index: 24224 = 0x5EA0	
<p>The baud rate over the CAN bus can be set using this code.</p> <p>Prior to accessing the CAN bus, the baud rate used is determined by the communication module and is compared with the baud rate configured.</p> <p>If there is a difference between the two values, the baud rate determined is used. Code C1209 can be used to read out the baud rate detected by the communication module.</p> <p>If there is no data exchange on the CAN bus, the baud rate cannot be determined. The subsequent response of the communication module depends on the selection configured in code C0351:</p> <p>Selection 0 ... 5 After a time-out that can be configured using code C1215, the CAN bus is accessed with the baud rate configured.</p> <p>Selection 16 (automatic detection of the baud rate) The communication module is not accessed by the bus until a baud rate has been detected.</p> <p>Changes that are made to the settings will be accepted after ...</p> <ul style="list-style-type: none"> • reconnection to the mains; • a "Reset node" command via the bus system; • a "Reset node" via code C0358. 			
Selection list (Lenze setting printed in bold)			
	0	500 kbit/s	
	1	250 kbit/s	
	2	125 kbit/s	
	3	50 kbit/s	
	4	1000 kbps	
	5	20 kbit/s	
	16	Autom. baud rate detection	
<input checked="" type="checkbox"/> Read access <input checked="" type="checkbox"/> Write access <input type="checkbox"/> CINH <input type="checkbox"/> PLC STOP <input type="checkbox"/> No transfer			

9 Parameter reference

C0358

Parameter Name: C0358 CAN reset node		Data type: INTEGER_32 Index: 24217 = 5E99
After a reset any changes to communication parameters such as baud rate or node address are applied. A "Reset node" can be activated by:...		
<ul style="list-style-type: none">• reconnection of the mains;• a "Reset node" via the bus system;• a "Reset node" via code C0358.		
Selection list (Lenze setting printed in bold)		
0	No function	
1	CAN reset	
<input checked="" type="checkbox"/> Read access <input checked="" type="checkbox"/> Write access <input type="checkbox"/> CINH <input type="checkbox"/> PLC STOP <input checked="" type="checkbox"/> No transfer		

C0359

Parameter Name: C0359 CAN bus status		Data type: INTEGER_32 Index: 24216 = 0x5E98
<p>This code displays the current operating status of the CAN controller. Here, the following states are distinguished:</p> <p>Selection 0: "Operational" In this state the bus system is fully functional.</p> <p>Selection 1: "Pre-operational" In this state only parameter data (codes) can be transferred via the bus system. It is not possible to exchange process data. To change to the "Operational" state, a network management frame must be output on the bus. A state change from "Pre-operational" to "Operational" can be made with the following actions:</p> <ul style="list-style-type: none"> • A drive is defined as master using the inverter code C0352. During mains connection, an automatic state change for the whole drive system is performed after the boot-up time defined in C0356/1 • "Reset node" via code C0358 (precondition: C0352 = 1). • With the "Reset node" binary input signal which can, for instance, be set via a terminal if inverter code C0364 is configured accordingly (precondition: C0352 = 1). • A network management message from a CAN master. <p>Selection 2: "Warning" Incorrect frames have been received if the state is "Warning". The CAN node is now only involved in a passive way; no more data are sent from the inverter. The reason for this situation can be:</p> <ul style="list-style-type: none"> • A missing bus terminator • Inadequate shielding • Potential differences at the ground connection for the control electronics • An excessively high bus load • CAN node is not connected to the bus <p>Selection 3: "Bus Off" The frequency of the erroneous frames has caused the CAN node to decouple from the bus. A change-over to "Pre-Operational" can be effected by ...</p> <ul style="list-style-type: none"> • a "TRIP reset"; • a "Reset node"; • reconnection to the mains. <p>Selection 4: "Stopped" Only NMT frames can be received. The state can be changed to "Pre-operational" by ...</p> <ul style="list-style-type: none"> • a "Reset node" via code C0358; • a "Reset node" via the bus system; • reconnection to the mains. 		
Selection list (read only)		
0	Operational	
1	Preoperational	
2	Warning	
3	Bus Off	
4	Stopped	
<input checked="" type="checkbox"/> Read access <input type="checkbox"/> Write access <input type="checkbox"/> CINH <input type="checkbox"/> PLC-STOP <input type="checkbox"/> No transfer		

9 Parameter reference

C0360

Parameter Name: C0360 CAN frame counter		Data type: INTEGER_32 Index: 24215 = 0x5E97
All CAN frames of the CAN node that have been transmitted and received are counted. The counters have 32 bits, i. e. when a value of 4294967295 is exceeded, the counting process starts again at 0.		
Display range (min. value unit max. value)		
-2147483647		2147483647
Subcodes		Info
C0360/1		Number of frames transmitted
C0360/2		Number of frames received
<input checked="" type="checkbox"/> Read access <input type="checkbox"/> Write access <input type="checkbox"/> CINH <input type="checkbox"/> PLC-STOP <input type="checkbox"/> No transfer		

C0361

Parameter Name: C0361 CAN bus load		Data type: INTEGER_32 Index: 24214 = 0x5E96
Using this code the percentage total bus load can be determined. Erroneous messages are not taken into account here. Note:		
<ul style="list-style-type: none"> • The bus load for all devices involved should not exceed 80 %. • If other devices, e. g. decentralised inputs and outputs are connected, these messages are also to be taken into account. 		
Display range (min. value unit max. value)		
0	%	100
<input checked="" type="checkbox"/> Read access <input type="checkbox"/> Write access <input type="checkbox"/> CINH <input type="checkbox"/> PLC-STOP <input type="checkbox"/> No transfer		

C1200

Parameter Name: C1200 Parameter data channel		Data type: INTEGER_32 Index: 23375 = 0x5B4F
This code indicates which of the two parameter data channels is used to communicate with other nodes. The unused parameter data channels can be switched off, if required. All Lenze inverters are provided with two parameter data channels featuring different addresses. The address of parameter data channel 2 is calculated as follows: Address of parameter data channel 2 = address of parameter data channel 1 + offset 64		
Note: The selection 0 means that the bus is operating in compliance with CANopen and there is no limitation on the address space. In this case, the parameter data channel SDO2 is inactive.		
Selection list (Lenze setting printed in bold)		
0	CANopen	
1	1	
2	2	
<input checked="" type="checkbox"/> Read access <input checked="" type="checkbox"/> Write access <input type="checkbox"/> CINH <input type="checkbox"/> PLC STOP <input type="checkbox"/> No transfer		

Address ranges

Selection	Accessible address range	Active parameter data channels
0	1...127	SDO 1
1	1 ... 63	SDO 1 / SDO 2
2	65 ... 127	SDO 1 / SDO 2

9 Parameter reference

C1201

Parameter Name: C1201 CAN communication time-out			Data type: INTEGER_32 Index: 23374 = 0x5B4E
The time set defines the time frame within which a CAN node must respond to a request. If there is no response by the node, the requesting communication module assumes that the node is not available.			
Setting range (min. value unit max. value)			Lenze setting
500	MS	100000	1500 ms
<input checked="" type="checkbox"/> Read access <input checked="" type="checkbox"/> Write access <input type="checkbox"/> CINH <input type="checkbox"/> PLC STOP <input type="checkbox"/> No transfer			

C1202

Parameter Name: C1202 Time limit for finding nodes			Data type: INTEGER_32 Index: 23373 = 0x5B4D
For node search, the time set is regularly maintained. It must be selected high enough to enable the nodes to have enough time to respond. Otherwise, a too high value delays the search.			
Note: If required, the settings in C1202 must be adapted if the delay time for search frames is increased using code C1227 .			
Setting range (min. value unit max. value)			Lenze setting
500	MS	3500	1000 ms
<input checked="" type="checkbox"/> Read access <input checked="" type="checkbox"/> Write access <input type="checkbox"/> CINH <input type="checkbox"/> PLC STOP <input type="checkbox"/> No transfer			

C1203

Parameter Name: C1203 Retries			Data type: INTEGER_32 Index: 23372 = 0x5B4C
The value to be set in code C1203 indicates the number of repetitions of those CAN frames which have not reached the receiver. The precondition for using this functionality is the activation of the device identification via code C1219 .			
Setting range (min. value unit max. value)			Lenze setting
0		10	1
			The following setting applies from version 1.7 onwards! 0 The Lenze setting of the repeat tests was changed to "0" in order to obtain a corresponding return value from the communication module as soon as possible if a bus node is not available ("DEVICE_NOT_PRESENT").
<input checked="" type="checkbox"/> Read access <input checked="" type="checkbox"/> Write access <input type="checkbox"/> CINH <input type="checkbox"/> PLC STOP <input type="checkbox"/> No transfer			

9 Parameter reference

C1209

Parameter Name: C1209 Read out CAN baud rate		Data type: INTEGER_32 Index: 23366 = 0x5B46
Code C1209 can be used to determine which baud rate was detected on the CAN bus. When "16" is displayed, no data are exchanged on the CAN bus.		
Selection list (read only)		
0	500 kbit/s	
1	250 kbit/s	
2	125 kbit/s	
3	50 kbit/s	
4	1000 kbps	
5	20 kbit/s	
16	not detected	
<input checked="" type="checkbox"/> Read access <input type="checkbox"/> Write access <input type="checkbox"/> CINH <input type="checkbox"/> PLC-STOP <input type="checkbox"/> No transfer		

C1210

Parameter Name: C1210 IP address		Data type: UNSIGNED_32 Index: 23365 = 0x5B45
<p>The IP address is the identification number of a device in the network. Each network node receives a unique address in the network. Compared to the MAC-ID, the IP address is a logic address that can be changed via software.</p> <p>By default, the address 0.0.0.0 is set. Since this is not a valid IP address, the device searches for a free address in the subnetwork 169.254.xxx.xxx at the start, as specified by the APIPA process.</p> <p>The IP addresses always consist of 4 octets (subcodes 1 ... 4). In order to improve readability, the octets are separated from each other by points (e.g. 128.133.10.123).</p> <p>The first octet determines the network class. The network class specifies the number of available hosts in a network.</p> <p>Note: The data are only accepted when the mains has been switched the next time.</p> <p>The following function is available from version 1.7 onwards!</p> <p>After the code has been changed, the IP address and subnet mask combination is checked with regard to its validity. If the IP address and subnet mask combination is invalid, the gateway is set to the IP address 0.0.0.0, and DHCP is set to dynamic assignment of the IP address (code C1228).</p>		
Setting range (min. value unit max. value)		
0		255
Subcodes	Lenze setting	Info
C1210/1	0	IP address 1
C1210/2	0	IP address 2
C1210/3	0	IP address 3
C1210/4	0	IP address 4
<input checked="" type="checkbox"/> Read access <input checked="" type="checkbox"/> Write access <input type="checkbox"/> CINH <input type="checkbox"/> PLC STOP <input type="checkbox"/> No transfer		

The IP addresses are divided into 3 classes:

Class	IP address classes	Maximum number of hosts
a	01.x.x.x - 126.x.x.x	16.777.214
B	128.x.x.x - 191.x.x.x	65.534
C	192.x.x.x - 223.x.x.x	254

x: complete octet

9 Parameter reference

C1211

Parameter Name: C1211 Subnet mask		Data type: UNSIGNED_32 Index: 23364 = 0x5B44
<p>The IP address (C1210) is superimposed by the subnet mask. The subnet mask serves to identify which part of the IP address indicates the network and which part represents the device part in the network. All bits of the network part of the subnetwork mask are set to the value "1", and all bits of the device part are set to the value "0".</p> <p>A logic AND operation of both binary codes provides information on ...</p> <ul style="list-style-type: none"> • the network ID, • the corresponding network, • the computer ID. <p>The TCP/IP protocol is used to determine the path of the message:</p> <ul style="list-style-type: none"> • Same network: communication via broadcast • Other network: communication via router <p>The standard subnet masks are divided into 3 classes:</p> <ul style="list-style-type: none"> • Class A: 255.0.0.0 • Class B: 255.255.0.0 • Class C: 255.255.255.0 <p>Note: The data are only accepted when the mains has been switched the next time. The following function is available from version 1.7 onwards! After the code has been changed, the IP address and subnet mask combination is checked with regard to its validity. If the IP address and subnet mask combination is invalid, the gateway is set to the IP address 0.0.0.0, and DHCP is set to dynamic assignment of the IP address (code C1228).</p>		
Setting range (min. value unit max. value)		
0		255
Subcodes	Lenze setting	Info
C1211/1	0	Subnet mask 1
C1211/2	0	Subnet mask 2
C1211/3	0	Subnet mask 3
C1211/4	0	Subnet mask 4
<input checked="" type="checkbox"/> Read access <input checked="" type="checkbox"/> Write access <input type="checkbox"/> CINH <input type="checkbox"/> PLC STOP <input type="checkbox"/> No transfer		

C1214

Parameter Name: C1214 MAC address		Data type: VISIBLE_STRING Index: 23361 = 0x5B41
<p>Each communication module has a 48-bit identification, the so-called MAC-ID (Media Access Control). The MAC-ID is stored non-volatilely in the EEPROM of the communication module.</p> <p>Basically, the identification of the communication module is allocated by the IEEE (Institute of Electrical and Electrical Engineers). The IEEE assigns a so-called OUI (Organizationally Unique Identifier) to each manufacturer. The OUI represents the first 24 bits of the card address. The remaining bits of the address are assigned by the manufacturer for each card. The numbering of each card must be unique.</p>		
<input checked="" type="checkbox"/> Read access <input type="checkbox"/> Write access <input type="checkbox"/> CINH <input type="checkbox"/> PLC-STOP <input type="checkbox"/> No transfer		

C1215

Parameter Name: C1215 CAN time-out		Data type: INTEGER_32 Index: 23360 = 0x5B40
<p>By defining a time-out in code C1215, the baud rate (display with code C1209) on the CAN bus can be determined. The baud rate is not checked if the value configured in code C1215 is set to zero.</p> <p>When the time-out configured in code C1215 elapses, the CAN bus is accessed (for further information and restriction: see description of code C0351).</p>		
Setting range (min. value unit max. value)		Lenze setting
0	MS	60000
		1000 ms
<input checked="" type="checkbox"/> Read access <input checked="" type="checkbox"/> Write access <input type="checkbox"/> CINH <input type="checkbox"/> PLC STOP <input type="checkbox"/> No transfer		

9 Parameter reference

C1216

Parameter Name: C1216 User-specific device name	Data type: VISIBLE_STRING Index: 23359 = 0x5B3F
<p>The device name can be defined with maximally 25 characters by the user. The following characters can be used for creating or changing the name:</p> <ul style="list-style-type: none"> • Letters: A ... Z, a ... z • Numbers: 0 ... 9 • Special characters: "." and "-" <p>Characters deviating from this are replaced by a point. The device name can also be entered on the gateway configuration web page.</p> <p>Notes:</p> <ul style="list-style-type: none"> • The device name is saved in the communication module with mains failure protection. • The automatic transfer of the device name to a DNS server does not take place. • By loading the Lenze standard setting (via code C0002) the device name is neither reset nor changed. 	
<input checked="" type="checkbox"/> Read access <input checked="" type="checkbox"/> Write access <input type="checkbox"/> CINH <input type="checkbox"/> PLC STOP <input type="checkbox"/> No transfer	

C1217

Parameter Name: C1217 Cycle time for CAN device monitoring	Data type: UNSIGNED_32 Index: 23358 = 0x5B3E
<p>This code serves to set the cycle time for CAN device monitoring (C1220). The cycle time can also be set via the gateway configuration web page.</p>	
Setting range (min. value unit max. value)	Lenze setting
1000 MS 30000	5000 ms
<input checked="" type="checkbox"/> Read access <input checked="" type="checkbox"/> Write access <input type="checkbox"/> CINH <input type="checkbox"/> PLC STOP <input type="checkbox"/> No transfer	

C1219

Parameter Name: C1219 Activation of CAN device monitoring	Data type: UNSIGNED_32 Index: 23356 = 0x5B3C
<p>The activated device monitoring enables the detection of bus nodes with disturbed bus communication. The device monitoring function can also be activated via code C1220/0 or the gateway configuration web page.</p>	
Selection list (Lenze setting printed in bold)	
0	Not activated
1	activated
<input checked="" type="checkbox"/> Read access <input checked="" type="checkbox"/> Write access <input type="checkbox"/> CINH <input type="checkbox"/> PLC STOP <input type="checkbox"/> No transfer	

9 Parameter reference

C1220

Parameter Name: C1220 CAN device monitoring		Data type: UNSIGNED_8 Index: 23355 = 0x5B3B
<p>This code serves to ...</p> <ul style="list-style-type: none"> • activate the CAN device monitoring function (subcode 0); • detect interrupted CAN communication for each node and record it in a bit mask (subcodes 1 ... 4) when the CAN device monitoring function is activated. <p>Recording of interrupted nodes</p> <p>Subcodes 1 ... 4 contain a bit mask in which each node (a maximum of 127) with interrupted bus communication or with an in-existent physical presence is recorded with the value "1".</p> <p>The status bit immediately adopts the value "0" when communication of the node has been re-established.</p> <p>For testing purposes, the bit mask can be written to by the user. The values written are accepted at the end of the CAN device monitoring cycle time in each case (C1217).</p> <p>In the »Engineer«, a change-over to the hexadecimal representation is recommended.</p>		
Setting range (min. value unit max. value)		
0		60000
Subcodes	Lenze setting	Info
C1211/0	0	0: device monitoring not activated 1: device monitoring activated (Activation can also be carried out via C1219 or the gateway configuration web page.)
C1211/1	0	Bits: 31 (MSB) ... 0 (LSB)
C1211/2	0	Bits: 63 (MSB) ... 32 (LSB)
C1211/3	0	Bits: 95 (MSB) ... 64 (LSB)
C1211/4	0	Bits: 127 (MSB) ... 96 (LSB)
<input checked="" type="checkbox"/> Read access <input checked="" type="checkbox"/> Write access <input type="checkbox"/> CINH <input type="checkbox"/> PLC STOP <input type="checkbox"/> No transfer		

C1224

Parameter Name: C1224 Gateway address		Data type: UNSIGNED_32 Index: 23351 = 0x5B37
<p>If the communication module is in another subnetwork than the Engineering PC, the IP address of the corresponding router must be entered into this code</p> <p>The data are only accepted when the mains has been switched the next time.</p>		
Setting range (min. value unit max. value)		
0		255
Subcodes	Lenze setting	Info
C1224/1	0	Gateway Address 1
C1224/2	0	Gateway Address 2
C1224/3	0	Gateway Address 3
C1224/4	0	Gateway Address 4
<input checked="" type="checkbox"/> Read access <input checked="" type="checkbox"/> Write access <input type="checkbox"/> CINH <input type="checkbox"/> PLC STOP <input type="checkbox"/> No transfer		

9 Parameter reference

C1227

Parameter Name: C1227 Delay time for search frames		Data type: INTEGER_32 Index: 23348 = 0x5B34
Searching the CAN bus during the start of a PC program can lead to faults if a bus is heavily loaded. In order to prevent this, a delay time between the transmission frames can be set. This, however, leads to an increase of the total search time. If required, the time limit for the node search (C1202) has to be adapted.		
Setting range (min. value unit max. value)		Lenze setting
0	MS	100 0 ms
<input checked="" type="checkbox"/> Read access <input checked="" type="checkbox"/> Write access <input type="checkbox"/> CINH <input type="checkbox"/> PLC STOP <input type="checkbox"/> No transfer		
Setting	Meaning	
0	Quickest possible search	
1 ... 10	Delay time 1 ms	
11 ... 19	Delay time 10 ms	
20 ... 29	Delay time 20 ms	
...	...	
90...100	Delay time 90 ms	

C1228

Parameter Name: C1228 DHCP activation		Data type: UNSIGNED_32 Index: 23347 = 0x5B33
This code enables access to the CAN bus system via the "Dynamic Host Configuration Protocol" (DHCP). Changes that are made to the settings will be accepted after ... <ul style="list-style-type: none"> • reconnection to the mains; • a device reset via code C1229 (with the value "2" or "3"). The parameterisation of this code is then stored with mains failure protection in the communication module immediately.		
Selection list (Lenze setting printed in bold)		
0	Not activated	
1	activated	
<input checked="" type="checkbox"/> Read access <input checked="" type="checkbox"/> Write access <input type="checkbox"/> CINH <input type="checkbox"/> PLC STOP <input type="checkbox"/> No transfer		

C1229

Parameter Name: C1229 Activation of IP settings, device reset		Data type: UNSIGNED_32 Index: 23346 = 0x5B32
This code ... <ul style="list-style-type: none"> • stores the IP adress, the network mask, and the gateway address with mains failure protection; • executes a device reset; • enables the combination of the two actions mentioned first. 		
Selection list (Lenze setting printed in bold)		Info
0	No function	
1	Save IP settings	The IP adress, the network mask, and the gateway address are saved in the communication module with mains failure protection.
2	Device reset	Reset of the communication module
3	Saving IP settings and device reset	Storage of the IP address, network mask, and gateway address with a subsequent device reset.
<input checked="" type="checkbox"/> Read access <input checked="" type="checkbox"/> Write access <input type="checkbox"/> CINH <input type="checkbox"/> PLC STOP <input type="checkbox"/> No transfer		

9 Parameter reference

C1230

Parameter Name: C1230 Current IP address (display)		Data type: UNSIGNED_32 Index: 23345 = 0x5B31
<p>This code shows the currently active IP address. An IP address that is altered using code C1210 will only become active after the next mains switching process. Until then, the currently active IP address differs from the IP address set in C1210.</p>		
Display range (min. value unit max. value)		
0		60000
<input checked="" type="checkbox"/> Read access <input type="checkbox"/> Write access <input type="checkbox"/> CINH <input type="checkbox"/> PLC-STOP <input type="checkbox"/> No transfer		

C1231

Parameter Name: C1231 Current subnet mask (display)		Data type: UNSIGNED_32 Index: 23344 = 0x5B30
<p>This code shows the currently active subnet mask. A subnet mask that is altered using code C1211 will only become active after the next mains switching process. Until then, the currently active subnet mask differs from the subnet mask set in C1211.</p>		
Display range (min. value unit max. value)		
0		60000
<input checked="" type="checkbox"/> Read access <input type="checkbox"/> Write access <input type="checkbox"/> CINH <input type="checkbox"/> PLC-STOP <input type="checkbox"/> No transfer		

C1232

Parameter Name: C1232 Current gateway address (display)		Data type: UNSIGNED_32 Index: 23343 = 0x5B2F
<p>This code shows the currently active gateway address. A gateway address that is altered using code C1224 will only become active after the next mains switching process. Until then, the currently active gateway address differs from the gateway address set in C1224.</p>		
Display range (min. value unit max. value)		
0		60000
<input checked="" type="checkbox"/> Read access <input type="checkbox"/> Write access <input type="checkbox"/> CINH <input type="checkbox"/> PLC-STOP <input type="checkbox"/> No transfer		

10 CANopen objects implemented

Lenze devices can be parameterised with both Lenze codes and manufacturer-independent "CANopen objects". Fully CANopen-compliant communication can only be achieved by exclusively using CANopen objects for the parameterisation. The CANopen objects described in this chapter are defined in the DS301 V4.02 CAN specification.



Note!

Some of the terms used here derive from the CANopen protocol.

This chapter lists the implemented CANopen objects of the communication module in numerically ascending order.

I-1000 - Device type

Index I-1000	Name: Device type					
Subindex	Lenze setting	Display range (min. value unit max. value)			Access	Data type
0: Device type	0	0		4294967295	ro	U32

The I-1000 CANopen index shows the profile for this device. Furthermore, additional information defined in the device profile itself can be shown here.

If you are not working according to a specific device profile, the content is "0x0000".

Data frame assignment

Byte 8	Byte 7	Byte 6	Byte 5
U32			
Device profile number		Additional information	

I-1001 - Error register

Index: I-1001	Name: Error register					
Subindex	Lenze setting	Display range (min. value unit max. value)			Access	Data type
0: Error register	-	0		255	ro	U8

The error register displays the error status in data bytes (U8) in a bit-coded form:

Bit 7	Bit 6	Bit 5	Bit 4	Bit 3	Bit 2	Bit 1	Bit 0	Error status
0	0	0	0	0	0	0	0	No error
0	0	0	0	0	0	0	1	Error of the communication module
0	0	0	1	0	0	0	1	Communication error

10 CANopen objects implemented

I-1017 - Producer heartbeat time

Index: I-1017		Name: Producer heartbeat time				
Subindex	Lenze setting	Input area (min. value unit max. value)			Access	Data type
0: Producer heartbeat time	0	0	MS	65535	rw	U16

The "heartbeat producer" cyclically sends a heartbeat message to one or several "heartbeat consumers".

After configuration of the producer heartbeat time, the heartbeat message is automatically transmitted at the transition from the NMT "Initialisation" state to the NMT "Pre-Operational" state when a time > 0 ms is set.



Note!

In contrast to "Node/Life guarding" monitoring, the heartbeat message does not contain a "Remote Transmit Request" (RTR).

Therefore a response by the receiver (consumer) upon receipt of a heartbeat message is not required.

I-1018 - Identity object

Index: I-1018		Name: Identity object				
Subindex	Lenze setting	Display range (min. value unit max. value)			Access	Data type
0: Highest subindex supported	see below	0		4294967295	ro	U32
1: Vendor ID						
2: Product code						
3: Revision number						
4: Serial number						

Subindex	Meaning
0	Highest subindex
1	Manufacturer's identification number The identification number allocated to Lenze by the "CAN in Automation e. V." organisation is "0x0000003B".
2	Product code
3	Revision number
4	Serial number

A

Access to the inverter codes [46](#)
Activation of CAN device monitoring (C1219) [61](#)
Activation of IP settings, device reset (C1229) [63](#)
Application as directed [11](#)
Application notes [8](#)
Application range [11](#)
Assigning a dynamic IP address [38](#)
Assigning a fixed IP address [37](#)
Assignment of the 9-pin Sub-D plug connector [21](#)
Automatic address allocation [43](#)
Automatic detection of the baud rate [43](#)

B

Baud rate [13](#)
Baud rate (CAN) [54](#)
Before initial switch-on [43](#)
Bus cable length [22](#)

C

C0002 | Load default setting [52](#)
C0093 | Device type [52](#)
C0099 | Software version [52](#)
C0150 | Status word [53](#)
C0200 | Software ID [53](#)
C0202 | Software ID (octet) [53](#)
C0350 | CAN node address [54](#)
C0351 | CAN baud rate [54](#)
C0358 | CAN reset node [55](#)
C0359 | CAN bus status [56](#)
C0361 | CAN bus load [57](#)
C1200 | Parameter data channel [57](#)
C1201 | CAN communication time-out [58](#)
C1202 | Time limit for finding nodes [58](#)
C1203 | Retries [58](#)
C1209 | Read out CAN baud rate [59](#)
C1210 | IP address [59](#)
C1211 | Subnet mask [60](#)
C1214 | MAC address [60](#)
C1215 | CAN time-out [60](#)
C1216 | User-specific device name [61](#)
C1217 | Cycle time for CAN device monitoring [61](#)
C1219 | Activation of CAN device monitoring [61](#)
C1220 | CAN device monitoring [62](#)
C1224 | Gateway address [62](#)
C1227 | Delay time for search frames [63](#)
C1228 | DHCP activation [63](#)
C1229 | Activation of IP settings, device reset [63](#)
C1230 | Current IP address (display) [64](#)
C1231 | Current subnet mask (display) [64](#)
C1232 | Current gateway address (display) [64](#)
CAN baud rate (C0351) [54](#)

CAN bus cable (specification) [21](#)
CAN bus load (C0361) [57](#)
CAN bus status (C0359) [56](#)
CAN communication time-out (C1201) [58](#)
CAN device monitoring (C1220) [62](#)
CAN frame counter [57](#)
CAN frame counter (C0360) [57](#)
CAN node address [54](#)
CAN reset node (C0358) [55](#)
CAN time-out (C1215) [60](#)
CANopen objects implemented [65](#)
CANopen parameter channels [47](#)
Codes [52](#)
Codes of the inverter (access) [46](#)
Colour code of the Ethernet cable [27](#)
Commissioning [31](#)
Commissioning with the Lenze "System bus configurator" [31](#)
Commissioning with the web server [35](#)
Communication media [13](#)
Compatibility with CANopen [47](#)
Completion of the configuration [34](#)
Configuration completed [34](#)
Configuring the communication module [32](#)
Connecting the CAN bus [20](#)
Connecting the Ethernet cable [25](#)
Connection of Ethernet [25](#)
Connection of the CAN bus [20](#)
Connections [12](#)
Conventions [6](#)
Conventions used [6](#)
Current gateway address (display) (C1232) [64](#)
Current IP address (display) (C1230) [64](#)
Current subnet mask (display) (C1231) [64](#)
Cycle time for CAN device monitoring (C1217) [61](#)

D

Data transfer [46](#)
Data transfer via CAN [47](#)
Data transfer via Ethernet [48](#)
Delay time for search frames (C1227) [63](#)
Detection of the baud rate [43](#)
Device and application-specific safety instructions [10](#)
Device protection [10](#)
Device type (C0093) [52](#)
Device type (I-1000) [65](#)
DHCP activation (C1228) [63](#)
Diagnostics [49](#)
Dimensions [15](#)
Dismounting [18](#)
Displaying alarms and events [42](#)
Document history [5](#)

Index

E

Electrical installation [19](#)
E-mail to Lenze [69](#)
Error: Cause and remedy [49](#)
Error register (I-1001) [65](#)
Ethernet cable (specification) [26](#)
Ethernet cable specification [26](#)
Ethernet cable, colour code [27](#)
Ethernet cable, structure [26](#)
Ethernet states [41](#)

F

Feedback to Lenze [69](#)

G

Gateway address (C1224) [62](#)
General data [13](#)
General safety instructions and application notes [9](#)

I

I-1000 (device type) [65](#)
I-1001 (error register) [65](#)
I-1017 (producer heartbeat time) [66](#)
I-1018 (identity object) [66](#)
Identification [12](#)
Identity object (I-1018) [66](#)
Indexing of codes [46](#)
Initial switch-on [44](#)
Installation [16](#)
Installing/updating software [31](#)
Interfaces [12](#)
IP address (C1210) [59](#)

L

Layout of the safety instructions [8](#)
LED signalling at initial switch-on [44](#)
LED signalling in compliance with DR303-3 [45](#)
LED status displays for Ethernet communication [51](#)
LED status displays for the communication module and for CAN communication [49](#)
Load default setting (C0002) [52](#)

M

MAC address (C1214) [60](#)
Mechanical installation [17](#)

N

Nameplate [12](#)
Number of nodes [13](#)

O

Operating conditions [13](#)

P

Parameter data channel (C1200) [57](#)
Parameter reference [52](#)
Pin assignment [28](#)
Producer heartbeat time (I-1017) [66](#)
Product description [11](#)
Protective insulation [14](#)

R

Read out CAN baud rate (C1209) [59](#)
Residual hazards [10](#)
Retries (C1203) [58](#)

S

Safety instructions [8](#), [9](#)
Screenshots/application examples [4](#)
Segment cable length [23](#)
Signalling in compliance with DR303-3 [45](#)
Signalling of the LEDs at initial switch-on [44](#)
Software ID (C0200) [53](#)
Software ID (octet) (C0202) [53](#)
Software version (C0099) [52](#)
Specification of the CAN bus cable [21](#)
Status displays for Ethernet communication [51](#)
Status displays for the communication module and for CAN communication [49](#)
Status word (C0150) [53](#)
Structure of the Ethernet cable [26](#)
Structure of the safety instructions [8](#)
Sub-D-plug connector (assignment) [21](#)
Subnet mask (C1211) [60](#)
System bus configurator [31](#)

T

Target group [4](#)
Technical data [13](#)
Terminals [30](#)
Terminology used [7](#)
Time limit for finding nodes (C1202) [58](#)
Total cable length [22](#)

U

Use of repeaters [24](#)
User-specific device name (C1216) [61](#)
Using the communication module [11](#)

V

Validity [4](#)
Voltage supply [13](#), [29](#)

FEEDBACK



Your opinion is important to us

These instructions were created to the best of our knowledge and belief to give you the best possible support for handling our product.

Perhaps we have not succeeded in achieving this objective in every respect. If you have suggestions for improvement, please e-mail us to:

feedback-docu@lenze.com

Thank you very much for your support.

Your Lenze documentation team

Lenze Automation GmbH
Postfach 10 13 52, 31763 Hameln
Hans-Lenze-Straße 1, 31855 Aerzen
GERMANY
HR Hannover B 205381
☎ +49 5154 82-0
📠 +49 5154 82-2800
✉ lenze@lenze.com
🌐 www.lenze.com

Service

Lenze Service GmbH
Breslauer Straße 3, 32699 Extertal
GERMANY
☎ 008000 24 46877 (24 h helpline)
📠 +49 5154 82-1112
✉ service@lenze.com