

ATM60-D4H13x13

ATM60 DeviceNet

ABSOLUTE ENCODERS

SICK
Sensor Intelligence.

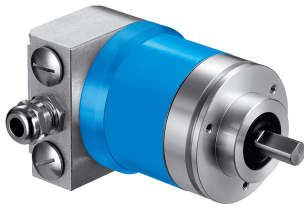
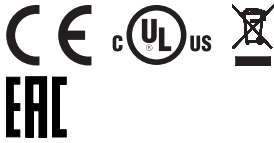

Illustration may differ



Ordering information

Type	Part no.
ATM60-D4H13x13	1030017

Other models and accessories → www.sick.com/ATM60_DeviceNet

Detailed technical data

Performance

Max. resolution (number of steps per revolution x number of revolutions)	13 bit x 13 bit (8,192 x 8,192)
Error limits G	0.25° ¹⁾
Repeatability standard deviation σ_r	0.1° ²⁾

¹⁾ In accordance with DIN ISO 1319-1, position of the upper and lower error limit depends on the installation situation, specified value refers to a symmetrical position, i.e. deviation in upper and lower direction is the same.

²⁾ In accordance with DIN ISO 55350-13; 68.3% of the measured values are inside the specified area.

Interfaces

Communication interface	DeviceNet™
Data protocol	DeviceNet Specification Release 2.0
Address setting	0 ... 63, DIP switches or protocol
Data transmission rate (baud rate)	DIP switches or protocol, 125 kBaud 250 kBaud 500 kBaud
Status information	Network status LED, 2-colours
Bus termination	DIP switch ¹⁾
Initialization time	1,250 ms ²⁾
Position forming time	+ 0.25 ms
SSI	
Set (electronic adjustment)	Via PRESET push button or protocol

¹⁾ Should only be connected in the final device.

²⁾ Valid positional data can be read once this time has elapsed.

Electrical data

Connection type	Connection adapter for DeviceNet ¹⁾
Supply voltage	10 ... 32 V

¹⁾ Please order the bus adaptor separately.

²⁾ This product is a standard product and does not constitute a safety component as defined in the Machinery Directive. Calculation based on nominal load of components, average ambient temperature 40°C, frequency of use 8760 h/a. All electronic failures are considered hazardous. For more information, see document no. 8015532.

Reverse polarity protection	✓
MTTFd: mean time to dangerous failure	150 years (EN ISO 13849-1) ²⁾

¹⁾ Please order the bus adaptor separately.

²⁾ This product is a standard product and does not constitute a safety component as defined in the Machinery Directive. Calculation based on nominal load of components, average ambient temperature 40 °C, frequency of use 8760 h/a. All electronic failures are considered hazardous. For more information, see document no. 8015532.

Mechanical data

Mechanical design	Solid shaft, face mount flange
Shaft diameter	10 mm
Wavelength	19 mm
Weight	0.59 kg
Shaft material	Stainless steel
Flange material	Aluminum
Housing material	Aluminum die cast
Start up torque	2.5 Ncm, with shaft seal 0.5 Ncm, without shaft seal
Operating torque	1.8 Ncm, with shaft seal 0.3 Ncm, if the shaft seal has been removed by the customer
Permissible Load capacity of shaft	300 N / radial 50 N / axial
Moment of inertia of the rotor	35 gcm ²
Bearing lifetime	3.6 x 10 ⁹ revolutions
Angular acceleration	≤ 500,000 rad/s ²
Operating speed	≤ 6,000 min ⁻¹

Ambient data

EMC	According to EN 61000-6-2 and EN 61000-6-3
Enclosure rating	IP67, with shaft seal (according to IEC 60529) IP43, without shaft seal, on encoder flange not sealed (according to IEC 60529) IP66, without shaft seal, on encoder flange sealed (according to IEC 60529)
Permissible relative humidity	98 %
Operating temperature range	-20 °C ... +85 °C
Storage temperature range	-40 °C ... +125 °C, without package
Resistance to shocks	100 g, 6 ms (according to EN 60068-2-27)
Resistance to vibration	20 g, 10 Hz ... 2,000 Hz (according to EN 60068-2-6)

Classifications

ECl@ss 5.0	27270502
ECl@ss 5.1.4	27270502
ECl@ss 6.0	27270590
ECl@ss 6.2	27270590
ECl@ss 7.0	27270502
ECl@ss 8.0	27270502
ECl@ss 8.1	27270502
ECl@ss 9.0	27270502
ECl@ss 10.0	27270502

ECl@ss 11.0	27270502
ETIM 5.0	EC001486
ETIM 6.0	EC001486
ETIM 7.0	EC001486
UNSPSC 16.0901	41112113

Dimensional drawing (Dimensions in mm (inch))

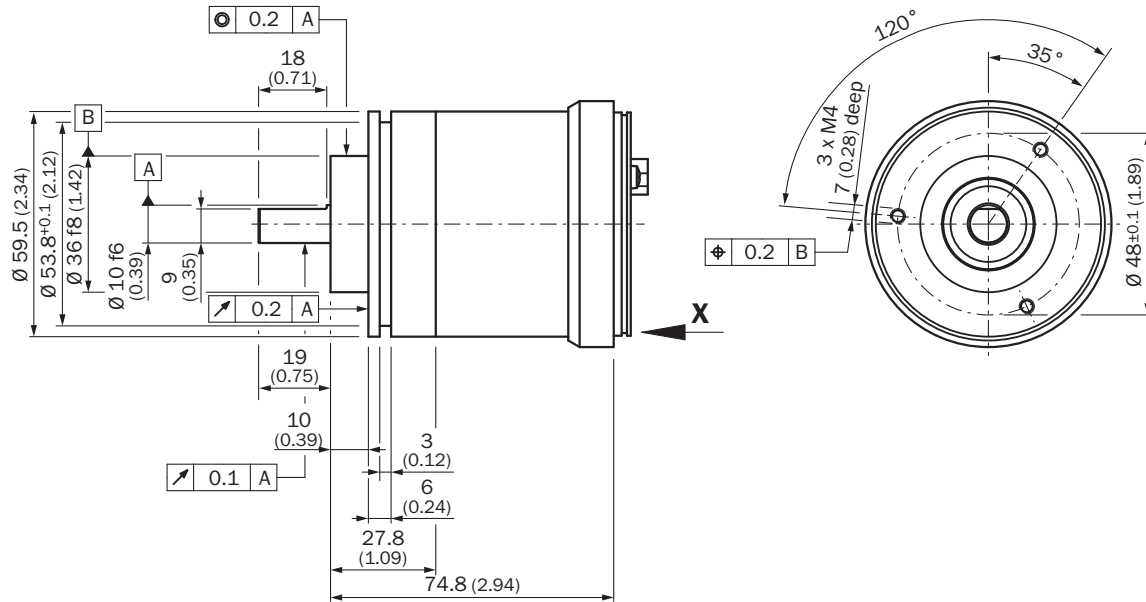



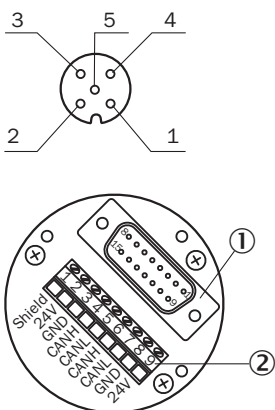

PIN assignment



Recommended accessories

Other models and accessories → www.sick.com/ATM60_DeviceNet

	Brief description	Type	Part no.
Flanges			
	Flange adapter, adaptation of face mount flange with 36 mm centering hub to 50 mm servo flange, aluminum, including 3 flat head screws M4 x 10, Aluminum, including 3 countersunk screws M4 x 10	BEF-FA-036-050	2029160
	Flange adapter, adaptation of face mount flange with 36 mm centering hub to 60 mm square mounting plate, aluminum, including 3 flat head screws M4 x 8, Aluminum, including 3 countersunk screws M4 x 8	BEF-FA-036-060REC	2029162
	Flange adapter, adaptation of face mount flange with 36 mm centering hub to 58 mm square mounting plate with shock absorbers, aluminum, Aluminum	BEF-FA-036-060RSA	2029163
	Flange adapter, adaptation of face mount flange with 36 mm centering hub to 100 mm servo flange with 60 mm centering hub, aluminum, Aluminum	BEF-FA-036-100	2029161
Mounting brackets and plates			
	Mounting bracket for encoder with spigot 36 mm for face mount flange, mounting kit included	BEF-WF-36	2029164
Shaft adaptation			
	Bellows coupling, shaft diameter 6 mm / 10 mm, maximum shaft offset: radial ± 0.25 mm, axial ± 0.4 mm, angular +/- 4°; max. speed 10,000 rpm, -30 °C to +120 °C, max. torque 80 Ncm; material: stainless steel bellows, aluminum hub	KUP-0610-B	5312982
	Spring washer coupling, shaft diameter 6 mm / 10 mm, Maximum shaft offset: radial +/- 0.3 mm, axial +/- 0.4 mm, angular +/- 2.5°; max. speed 12,000 rpm, -10° to +80 °C, max. torque 60 Ncm; material: aluminum flange, glass fiber-reinforced polyamide membrane and hardened steel coupling pin	KUP-0610-F	5312985
	Bellows coupling, shaft diameter 10 mm/10 mm; maximum shaft offset: radial +/- 0.25 mm, axial +/- 0.4 mm, angular +/- 4°; max. revolutions 10,000 rpm, -30° to +120 °C, max. torque 80 Ncm; material: stainless steel bellows, aluminum clamping hubs	KUP-1010-B	5312983
	Spring washer coupling, shaft diameter 10 mm / 10 mm, maximum shaft offset, radial ± 0.3 mm, axial ± 0.4 mm, angle ± 2.5°, torsion spring stiffness 30 Nm/rad; material: aluminum flange, glass-fiber reinforced polyamide membrane and hardened steel coupling pin	KUP-1010-F	5312986
	10 mm / 12 mm; maximum shaft offset: radial +/- 0.25 mm, axial +/- 0.4 mm, angular +/- 4°; max. revolutions 10,000 rpm, -30° to +120 °C, max. torque 80 Ncm; material: stainless steel bellows, aluminum clamping hubs	KUP-1012-B	5312984
Adapters and distributors			
	Bus adaptor KR1, 1 x PG	AD-ATM60-KR1DN	2029228
	Bus adaptor KR2, 2 x PG	AD-ATM60-KR2DN	2029229
	Bus adaptor SR1, 1 x M12, 5-pin	AD-ATM60-SR1DN	2029226
	Bus adaptor SR2, 2 x M12, 5-pin	AD-ATM60-SR2DN	2029227
Plug connectors and cables			
	Head A: Flying leads Head B: Flying leads Cable: CANopen, DeviceNet™, shielded Wire shield Al-Pt film, overall shield C-screen tin-plated	LTG-2804-MW	6028328

	Brief description	Type	Part no.
	Head A: female connector, M12, 5-pin, straight Head B: male connector, M12, 5-pin, straight Cable: CANopen, DeviceNet™, PUR, halogen-free, unshielded, 6 m	DSL-1205-G06MK	6028327
	Head A: female connector, M12, 5-pin, straight Cable: CANopen, DeviceNet™, shielded	DOS-1205-GA	6027534
	Head A: male connector, M12, 5-pin, straight, A-coded Cable: CANopen, DeviceNet™, shielded	STE-1205-GA	6027533

SICK AT A GLANCE

SICK is one of the leading manufacturers of intelligent sensors and sensor solutions for industrial applications. A unique range of products and services creates the perfect basis for controlling processes securely and efficiently, protecting individuals from accidents and preventing damage to the environment.

We have extensive experience in a wide range of industries and understand their processes and requirements. With intelligent sensors, we can deliver exactly what our customers need. In application centers in Europe, Asia and North America, system solutions are tested and optimized in accordance with customer specifications. All this makes us a reliable supplier and development partner.

Comprehensive services complete our offering: SICK LifeTime Services provide support throughout the machine life cycle and ensure safety and productivity.

For us, that is “Sensor Intelligence.”

WORLDWIDE PRESENCE:

Contacts and other locations –www.sick.com