



 **cabur**[®]
CONNECTING ENERGY
SINCE 1952

Automation and control solutions

2020 EDITION

Automation and control solutions

WARNING If not specified, the technical data in this catalogue are typical and measured at 25°C (77°F), 230 Vac, Unom, Vdc and rated current; ripple is measured at 20 MHz with probe connected to 0.1 µF. The technical data in this catalogue are typical and are not binding for Cabur and may be modified without prior notice, simply for production or improvement and/or evolution reason. Please contact our technical-commercial offices for any relevant confirmation or updates. For more informations visit our web site www.cabur.eu.

The Company

Founded in Italy in 1952, Cabur quickly conquered the role of leader amongst the national manufacturers of terminal blocks for electrical panels, always paying particular attention to the needs of installers and to cutting-edge technological solutions.

Today the company develops and manufactures a wide range of products for the electrotechnical and electronic industry which are renowned for their reliability even in extreme conditions of use.

The current production is the result of the many years of experience gained by Cabur as a partner of the main national bodies and companies, perfected through actions and collaborations abroad and includes:

- Connections for electrical panels
- Automation and control solutions
- Industrial marking systems
- Solutions for renewable energy

The wide and diversified offer guarantees a level of flexibility and unique ability to find solutions tailored to specific needs, which enables us to respond to the most varied and complex installation needs.

Always oriented towards the improvement of its products, in recent years Cabur has responded to the Industry 4.0 project with the expansion of production facilities and important product innovations.

In pursuing a corporate culture based on Total Quality, Cabur has adopted the main European directives of the reference market and collaborates with the most prestigious national and foreign Institutes and Laboratories.

Its products are the result of qualitative choices of particular relevance in the field of raw materials used that, in addition to providing an ample guarantee of functionality and reliability over time, also work in full compliance with all the Norms, Regulations, Laws and applicable requirements, binding and self-adopted, with full satisfaction of all compliance obligations.

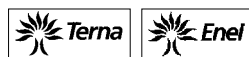

INDUSTRIAL CONNECTIVITY SOLUTIONS



AUTOMATION AND CONTROL SOLUTIONS



INDUSTRIAL MARKING SOLUTIONS



SOLUTIONS FOR RENEWABLE ENERGY

POWER SUPPLIES

INTRODUCTION	8	DC/DC CONVERTERS - CSA SERIES	55
QUICK SELECTION TABLE	10	LINEAR POWER SUPPLIES - AL SERIES.....	58
SINGLE PHASE POWER SUPPLIES - CSD SERIES	12	FILTERED POWER SUPPLIES - AR SERIES.....	59
SINGLE PHASE POWER SUPPLIES - CSF SERIES	17	UNINTERRUPTIBLE POWER SUPPLIES	60
SINGLE PHASE POWER SUPPLIES - CSL1 SERIES	26	REDUNDANCY MODULES	65
3-PHASE POWER SUPPLIES - CSL3 SERIES	36	COMMUNICATION INTERFACE	67
1-2-3-PHASE POWER SUPPLIES - CSW SERIES.....	43		
3-PHASE POWER SUPPLIES - CSG SERIES.....	49		

PROTECTION

MOTOR BRAKE CONTROLLER.....	70
ELECTRONIC OVERCURRENT PROTECTION.....	72
SURGE PROTECTION DEVICE.....	74

EMI FILTERS

3-PHASE WITHOUT NEUTRAL POLE - TDV SERIES.....	76
3-PHASE WITHOUT NEUTRAL POLE - TDS SERIES	79
3-PHASE WITH NEUTRAL POLE - TYT SERIES	81
3-PHASE WITH NEUTRAL POLE - TY SERIES	80
SINGLE PHASE SINGLE CELL FILTER - DK SERIES	82
SINGLE PHASE DOUBLE CELL FILTER - DP SERIES	84

SIGNAL CONDITIONERS

INTRODUCTION	88	FREQUENCY CONVERTERS	104
QUICK SELECTION TABLE	90	THRESHOLD MONITOR MODULES.....	105
GALVANIC ISOLATORS.....	92	AUXILIARY POTENTIOMETER FEEDER.....	108
PASSIVE GALVANIC ISOLATOR.....	98	NPN AND PNP SIGNAL INVERTER	109
SIGNAL DUPLICATOR.....	99	CONVERTER WITH MODBUS COMMUNICATON.....	110
TEMPERATURE CONVERTERS	100	BRIDGE	113
CURRENT CONVERTERS	103	DIN RAIL ETHERNET SWITCH	114

ELECTROMECHANICAL RELAY MODULES

QUICK SELECTION TABLE	117
SINGLE CHANNEL MODULES - R SERIES.....	118
SINGLE CHANNEL MODULES - CM SERIES.....	120
SINGLE CHANNEL MODULES - CKR SERIES.....	129
SINGLE CHANNEL MODULES - CWR SERIES.....	130
MULTI-CHANNEL MODULES - R SERIES	132
SUPER CHANNEL MODULES - CR SERIES	138

SOLID STATE RELAY MODULES

QUICK SELECTION TABLE	148
SINGLE CHANNEL MODULES	144
SINGLE CHANNEL MODULES - CKS SERIES	147
SIGNAL OPTOISOLATOR.....	150
MULTI-CHANNEL MODULES	152

INTERFACE MODULES

QUICK SELECTION TABLE	155
D-SUB CONNECTOR MODULES	156
IDC CONNECTOR MODULES.....	163
COMPONENTS HOLDER MODULES.....	173
DIODES HOLDER MODULES.....	175
LED TESTING MODULES.....	178
LAMP TESTING MODULES.....	180

ACCESSORIES

PLASTIC ENCLOSURES FOR ELECTRONIC BOARDS	182
JUMPER BRIDGES.....	186
DIN RAIL CLAMPS	188
MARKING TAGS AND LABELS	189
DIN MOUNTING RAILS	190
INDEX BY CODE	193
INDEX BY TYPE	194

POWER

PROTECTIONS

FILTERS

CONVERTERS

RELAY

SSR

INTERFACE

ACCESSORIES

POWER

DIN rail power supplies

Uninterruptible
power supplies

Cabur continues to renew and expand its range of power supplies for use in industrial automation and control of processes and systems, improving product performance and technology to meet the needs created by the continuing changes in applications and regulations.

QUALITY AND SAFETY: Cabur was the first Italian company to obtain UL508 Industrial Control Equipment certification for industrial automation processes and Hazardous Location Class 1 Div. 2 for processes in dangerous areas, as well as to have been certified as conforming to the Directives on Electric Safety. It also has been EMC certified by an accredited laboratory. All of these are indispensable for the CE certified label.

INNOVATION AND RESEARCH:

- 1997 - Cabur is the first Italian company to produce switching power supplies for DIN-rails with 90-264Vac/110-340Vdc universal input.
- 2001 - Cabur is the first Italian company to produce high efficiency power supplies with resonant technology (the 20A 3-phase dissipates only 36W compared to over 75W for our competitors at the time).
- 2009 - With the new generation of power supplies in the catalogue, Cabur has further improved performance using "Synchronous Rectifier" technology, which reduces power dissipation and operating temperature to the minimum, an indispensable factor in minimising the size of the power supplies, which are the smallest on the market.

The lifespan of a power supply is halved by every +10°C increase in operating temperature. Hence, reducing operating temperature is fundamental to endurance and reliability, two objectives that can be achieved only by using circuit technology and next generation components. Thanks to this combination, Cabur has achieved output of over 94% (the new 20A 3-phase dissipates only 28W, compared to the 50-75W in heat dissipation found in other products currently on the market).

HIGH OVERLOAD CAPACITY: the new power supplies have an overload capacity of over +50% for 5 seconds or for several minutes (please see the technical data), while maintaining stable output voltage even under these conditions.

SYSTEM COMMUNICATIONS: all the CSF, CSG, and CSW Series models are provided with "intelligent" alarm contacts that commutate when the output voltage drops below -10% of the nominal value. This allows the controls to activate automated or emergency procedures to reduce machine stoppage, production losses, and the risk to safety.

TOTAL PROTECTION: all models are provided with output protection against overload short circuiting, overtemperature, and overvoltage, both for input and output. Input for the 3-phase models includes the Active Surge Suppressor - Inrush Current Limiter, which avoids malfunctioning in the case of overvoltage generated by commutation of loads or malfunctions on industrial networks, where the value can reach 3-4 times the network voltage, with a duration of 1.3ms (Regulation VDE-0160), which can be destructive for the input components. This increases reliability, especially in networks subject to power surges and power malfunctions.

SHORT CIRCUIT AND OVERLOAD PROTECTION: this serves to protect the power supply from malfunctions due to overloading and overheating of the components. This function can be designed by starting with different application needs, with varying practical results and costs. In automated applications, the operating conditions and the nature of the loads can vary greatly and are only partially known to the power supply designer. Power supplies for automated processes need to meet a number of requirements: they need to be protected from overcurrent, but at the same time they need to be able to supply loads which call for a high peak current, working at temperatures of at least 45° C, according to regulations, and sometimes higher, in critical ventilation situations and guaranteeing high reliability and acceptable costs.

The overcurrent protection must support the high peak currents required by loads such as filament lamps (cold, they make a short circuit), capacitive loads such as dc/dc converters and filter condensators (when these switch on they are seen as a short-circuit for a few tenths of a ms) or inductive loads (engines in dc, electromagnets, etc.) which at peak require currents from 5 - 30 times their nominal power. Frequently, all these loads must be started up at the same time. The breakaway starting current must be provided for a sufficient duration to "start" the load, which can go from a few tenths of a ms up to 5s.

With high-power power supplies, which power various loads protected from overcurrent, the capacity to provide overcurrent is indispensable to guarantee selectivity in protection interventions. This is because it allows the fuse of the malfunctioning load to be "burned" before the electronic protection of the power supply intervenes, disconnecting the output and hence the entire system.

ELECTRONIC OVERLOAD POWER SUPPLY PROTECTION CAN BE OBTAINED USING VARIOUS TECHNIQUES:

- switch off the output as soon as possible: this is cost effective but doesn't allow for either start up of heavy loads nor for protection selectivity for various loads.
- constant power protection: if the allowed overload is sufficiently high, it is possible to start up heavy loads. However, if the condition continues, the power supply will continue to operate in overload and with a high thermal stress level. Hiccup protection: combines the advantages of the techniques described above, while limiting the disadvantages because it allows over +50-100% of the overload for at least 5 seconds, and then switches off output for a longer break. In this way, the peak power necessary for heavy load peaks is obtained while component heating is decreased, as they can cool off during the break. Hiccup protection with high overcurrent output, for durations from 200 ms to over 5 sec., has been proven to satisfy the new requirements established by the Machinery Directive EN 60204-1.

REAL OPERATING TEMPERATURE: the operating temperature range for all Cabur models is between -20 and +50°C at full load without derating (see technical data), certified in accordance with the rigorous UL508 standard.

The project takes into consideration the ambient temperature, allowed overcurrent, and overcurrent duration when determining component size, and is always more than the 45°C required by the standards for electrical panels. Ambient temperature is a fundamental reference parameter, because this influences not only performance, but also component operating temperature and power supply duration.

HOLD UP TIME: this is the time in which the power supply output supplies nominal voltage at nominal load. This performance is important because it limits the cases in which machine/system stoppage can occur due to voltage "holes" in the network. EMC standards establish that Hold Up time must be at least 10ms. For all Cabur power supplies, Hold Up time is greater than that required by the official standards, which ensures better operational consistency in networks with frequent voltage holes.

MTBF: this figure should be taken with care, because it is the result of theoretical calculations that are easy to manipulate. For example, if we know that the mortality rate for 25 year old men is 0.1%/year, the resultant MTBF, calculated in accordance with SN29500 - IEC 61709, would be 800 years. Obviously, this result is highly unrealistic. The significant piece of information is the "life expectancy," which for men averages about 75 years - less spectacular but more realistic. The same reasoning can be applied to electronic products for which, in accordance with the calculation methods, we can use an MTBF of 750,000 hours (85 years), or a life expectancy of about 70,000 hours (7.9 years, on average). The second estimate is less optimistic, but is without doubt closer to reality. As a consequence, data published regarding MTBF must be interpreted based on the credibility of the calculation methods used. In addition to the values according to SN 29500, Cabur has also chosen to declare those according to the MIL HDBK217F standards, which are much stricter.

CUSTOM POWER SUPPLIES: Cabur designs and produces "custom" power supplies on request to meet the requirements of regulations and the high demanding applications. Furthermore our laboratory offers technical documentation and the measures which prove the conformity of the products with the directives on Electric Safety and Electromagnetic Compatibility, besides the necessary technical support to define the product characteristics on the basis of the client's needs and our own experience.

THE ENVIRONMENT AND ROHS CONFORMANCE:

Cabur was one of the first Italian companies to obtain the International Environmental Certificate UNI EN ISO 14001, certified by CSQ for ecologically compatible treatment of all the materials used in our production. Since 2007, all Cabur products have been manufactured in conformity with the Rohs Wee directives.

General notes

PARALLEL AND REDUNDANT PARALLEL CONNECTION: all Cabur power supplies can be connected in parallel to combine the power of two or more power supplies. In addition, models that already include an output separation diode (ORing diode) are available for use with redundant parallels (please see the related item in the catalogue).

We recommend adjusting the outputs of all the power supply units to the same voltage (tolerance ± 50 mV), applying the same calibration load, before connecting them in parallel. We also recommend using power supply units of the same model. If it is necessary to connect two power supplies without internal diodes in redundant parallel, the connection must be completed as in fig. 1.

CONNECTION IN SERIES: all Cabur power supplies can have their outputs connected in series to double the voltage (see fig. 2) or to obtain dual voltage output, for example with ± 12 V or ± 24 V (see fig. 3).

We recommend that you use power supplies of the same model and an anti-parallel diode, of an appropriate size to resist the maximum current of the power supply.

POWER SIGNAL OK: this is found on all CSF, CSG, and CWS models. The 1A / 30Vdc contact commutates when output voltage falls below the threshold of -10% of nominal voltage, in the case of a short circuit on the output line or an overload that exceeds the specifications, or due to network failure.

100-340VDC POWER SUPPLY: available for certain models (please see technical data), which respect the following:

- power supply of 110...127 Vdc, reduces output current by 25%
- min. voltage allowed 100 Vdc, max 340 for single phase, 280...775 Vdc for single/2-phase, 564... 775Vdc for 3-phase (please see technical data)
- respect input polarity as indicated in the instructions.

Note for power supplies with secondary input from a transformer

ISOLATION: this series of power supply units is not insulated.

TYPE OF USE: they are suitable for use in PELV (Protective Extra Low Voltage, one pole grounded) and SELV (Safety Extra Low Voltage, no pole grounded).

The transformer used must have double or reinforced isolation in accordance with CEI 14.6 / EN 60742.

In the case of use in PELV circuits, only ground one pole of the 24 Vdc of the power supply unit. In the case of use in SELV circuits, do not ground the input grounding terminal.

Grounding one pole of the secondary of the transformer and the 24Vdc of the power supply would damage the power supply.

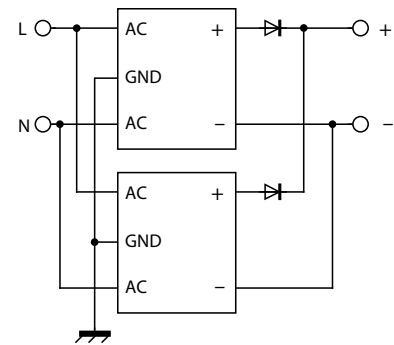

Figure 1

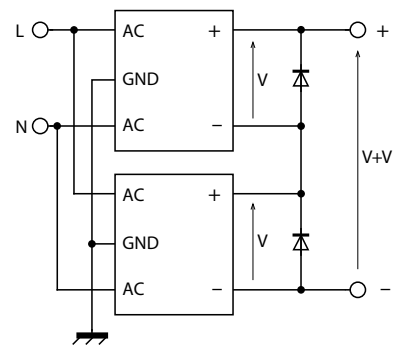

Figure 2

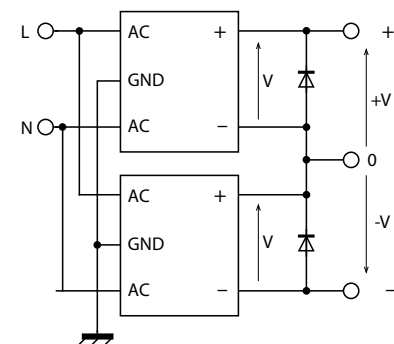

Figure 3

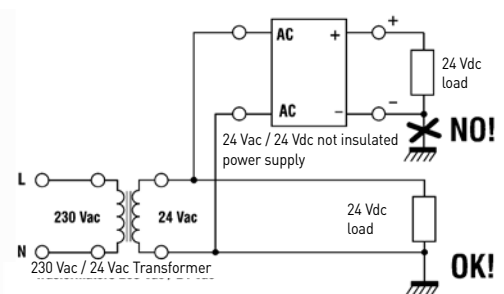

Figure 4

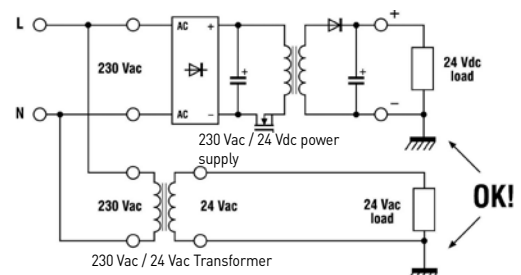

Figure 5

POWER SUPPLIES - QUICK SELECTION TABLE



POWER

PHASE	INPUT RATED VOLTAGE(AC)	INPUT VOLTAGE AC	INPUT VOLTAGE DC	OUTPUT RATED VOLTAGE (DC)	OUTPUT ADJUSTABLE RANGE	CONTINUOUS CURRENT (A)	ALARM CONTACT	REDUNDANT VERSION	TYPE	CODE	PAGE
1	12-24	10...26	-	1.2...24	—	0.3...1.5	—	—	CL1R	XCL1R	58
1	12-24	10...26	-	1.2...24	—	0.8...5	—	—	CL5R	XCL5R	58
1	12-24	6...20	-	U _{out} = (U _{in} x 1.41) - 2 V (full load)	-	6	—	—	AR6	XAR6	59
1	120-230	85...264	100...370	12	—	1.2	—	—	CSD1-015W/012V/AA	XCSD1015W012VAA	13
1	120-230	85...264	100...370	12	5...15	4...2.0	—	—	CSD1-030W/012V/AA	XCSD1030W012VAA	14
1	120-230	85...264	100...370	12	12...15	5...4	—	—	CSD1-072W/012V/AA	XCSD1072W012VAA	16
1	120-230	90...264	100...345	12	12...15	6	•	—	CSF85B	XCSF85B	20
1	120-230	90...264	100...345	±12...±15	±12...±15	2x 0.6	—	—	CSD30F	XCSD30F	15
1	120-230	85...264	100...370	24	—	0.6	—	—	CSD1-015W/024V/AA	XCSD1015W024VAA	13
1	120-230	85...264	100...370	24	—	1.25	—	—	CSD1-030W/024V/AA	XCSD1030W024VAA	14
1	120-230	85...264	100...370	24	23.5...27.5	3	—	—	CSD1-072W/024V/AA	XCSD1072W024VAA	16
1	120-230	90...264	100...320	24	—	1.2	—	—	CSF30C	XCSF30C	18
1	120-230	90...264	100...345	24	23...27.5	3.5	•	—	CSF85C	XCSF85C	19
1	120-230	90...264	100...345	24	23...27.5	3.5	•	•	CSF85CP	XCSF85CP	19
1	120-230	90...264	100...345	24	23...27.5	5	•	—	CSF120C	XCSF120C	21
1	120-230	90...264	100...345	24	23...27.5	5	•	•	CSF120CP	XCSF120CP	21
1	120-230	90...132 / 185...264	100...345	24	23...27.5	10	•	—	CSF240C	XCSF240C	23
1	120-230	90...132 / 185...264	100...345	24	23...27.5	10	•	•	CSF240CP	XCSF240CP	23
1	120-230	90...132 / 185...264	259-370	24	24...28	20	•	•	CSF500C	XCSF500C	25
1	120-230	85...264	100...370	24	16 ... 28	3	•	—	CSL1-072W/024V/AA	XCSL1072W024VAA	27
1	120-230	85...264	100...370	24	16 ... 28	5	•	—	CSL1-120W/024V/AA	XCSL1120W024VAA	27
1	120-230	90...264	—	24	23...27.5	3.5	—	—	CSL85C	XCSL85C	28
1	120-230	90...264	—	24	23...27.5	5	—	—	CSL120C	XCSL120C	28
1	120-230	90...132 / 185...264	—	24	23...27.5	10	—	—	CSL240C	XCSL240C	29
1	120-230	85...264	100...370	24	20 ... 28	20	•	—	CSL1-480W/024V/AA	XCSL1480W024VAA	30
1	120-230	85...264	100...370	24	20 ... 28	20	•	—	CSL1-480W/024V/GA	XCSL1480W024VGA	30
1	120-230	85...264	100...370	24	20 ... 28	20	•	—	CSL1-480W/024V/AB	XCSL1480W024VAB	31
1	230	187...264	—	24	23...27.5	20	•	—	CSL481C	XCSL481C	29
1	120-230	90...264	100...345	48	45...55	2.5	•	•	CSF120DP	XCSF120DP	22
1	120-230	90...132 / 185...264	100...345	48	45...55	5	•	•	CSF240DP	XCSF240DP	24
1	120-230	90...132 / 185...264	259-370	48	45...55	10	•	•	CSF500D	XCSF500D	25
1	120-230	85...264	100...370	48	40.5 ... 55.5	10	•	—	CSL1-480W/048V/AA	XCSL1480W048VAA	32
1	120-230	85...264	100...370	48	40.5 ... 55.5	10	•	—	CSL1-480W/048V/GA	XCSL1480W048VGA	32
1	120-230	85...264	100...370	48	40.5 ... 55.5	10	•	—	CSL1-480W/048V/AB	XCSL1480W048VAB	33
1	120-230	85...264	100...370	72	62.5 ... 81	6.6	•	—	CSL1-480W/072V/AA	XCSL1480W072VAA	34
1	120-230	85...264	100...370	72	62.5 ... 81	6.6	•	—	CSL1-480W/072V/GA	XCSL1480W072VGA	34
1	120-230	85...264	100...370	72	62.5 ... 81	6.6	•	—	CSL1-480W/072V/AB	XCSL1480W072VAB	35

- INFORMATION AVAILABLE
- INFORMATION NOT AVAILABLE

POWER SUPPLIES - QUICK SELECTION TABLE



PHASE	INPUT RATED VOLTAGE (AC)	INPUT VOLTAGE AC	INPUT VOLTAGE DC	OUTPUT RATED VOLTAGE (DC)	OUTPUT ADJUSTABLE RANGE	CONTINUOUS CURRENT (A)	ALARM CONTACT	REDUNDANT VERSION	TYPE	CODE	PAGE
1-2	230-400-500	187...550	270...725	12	12...15	8 - 7	•	—	CSW121B	XCSW121B	44
1-2	230-400-500	187...550	270...725	24	24...27.5	5	•	—	CSW121C	XCSW121C	44
1-2	230 / 400-500	180...264 / 360...550	550...775	24	23...27.5	40	•	•	CSW960CP	XCSW960CP	48
1-2-3	230-400-500	185...550	270...770	12	12...15	16 - 17	•	—	CSW241B	XCSW241B	45
1-2-3	230-400-500	185...550	270...770	24	24...27.5	10	•	—	CSW241C	XCSW241C	45
1-2-3	230-400-500	187...550	250...725	24	23.3...27.5	20	•	—	CSW481C	XCSW481C	47
1-2-3	230-400-500	185...550	270...770	48	45...55	5	•	•	CSW241DP	XCSW241DP	46
1-2-3	230-400-500	187...550	250...725	48	45...55	10	•	—	CSW481D	XCSW481D	47
1-2-3	230-400-500	187...550	250...725	72	72...85	6	•	—	CSW481G	XCSW481G	48
2-3	400-500	340...550	—	24	23.3...27.5	20	•	—	CSG481C	XCSG481C	50
2-3	400-500	340...550	—	24	24...28	20	•	—	CSG500C	XCSG500C	50
2-3	400-500	340...550	—	24	24...28	30	•	—	CSG720C	XCSG720C	51
2-3	400-500	340...550	—	24	24...28	40	•	—	CSG960C	XCSG960C	51
2-3	400-500	340...550	—	48	45...55	20	•	•	CSG960D	XCSG960D	52
2-3	400-500	340...550	—	72	72...85	13.3	•	•	CSG960G	XCSG960G	52
3	400-500	340...550	—	12-24	11.5 ... 29	100	•	•	CSG2401C	XCSG2401C	53
3	400-500	340...550	—	24	20 ... 28	20	•	—	CSL3-480W/024V/AA	XCSL3480W024VAA	36
3	400-500	340...550	—	24	20 ... 28	20	•	—	CSL3-480W/024V/GA	XCSL3480W024VGA	36
3	400-500	340...550	—	24	20 ... 28	20	•	—	CSL3-480W/024V/AB	XCSL3480W024VAB	37
3	400-500	340...550	—	24-48	23 ... 56	50	•	•	CSG2401D	XCSG2401D	53
3	400-500	340...550	—	48	40.5 ... 55.5	10	•	—	CSL3-480W/048V/AA	XCSL3480W048VAA	38
3	400-500	340...550	—	48	40.5 ... 55.5	10	•	—	CSL3-480W/048V/GA	XCSL3480W048VGA	38
3	400-500	340...550	—	48	40.5 ... 55.5	10	•	—	CSL3-480W/048V/AB	XCSL3480W048VAB	39
3	400-500	340...550	—	72	50 ... 87	33	•	•	CSG2401G	XCSG2401G	54
3	400-500	340...550	—	72	60 ... 81	6.6	•	—	CSL3-480W/072V/AA	XCSL3480W072VAA	40
3	400-500	340...550	—	72	60 ... 81	6.6	•	—	CSL3-480W/072V/GA	XCSL3480W072VGA	40
3	400-500	340...550	—	72	60 ... 81	6.6	•	—	CSL3-480W/072V/AB	XCSL3480W072VAB	41
3	400-500	340...550	—	100-110-170	88...175	14	•	•	CSG2401R	XCSG2401R	54
—	—	—	10.5...18	24	22.5...27.5	5	—	—	CSA120BC	XCSA120BC	55
—	—	—	18...36	12...15	12...15	7	—	—	CSA120CB	XCSA120CB	55
—	—	—	18...36	24	22.5...27.5	5	—	—	CSA120CC	XCSA120CC	56
—	—	—	36...72	24	22.5...27.5	5	—	—	CSA120DC	XCSA120DC	56
—	—	—	100...130	24	23...27	10	—	•	CSA240FC	XCSA240FC	57

- CARATTERISTICA DISPONIBILE
- CARATTERISTICA / INFORMAZIONE NON DISPONIBILE

Single-phase switching power supply with power up to 70W for use in civil and industrial automation applications. The technical and design characteristics of the housing, with standard modular DIN measurements for installation in control units **were planned to optimise use in home automation**. The performance level and compact size also make it an excellent solution for electrical panels and shallow containers.

High output and a contained working temperature support energy savings and longer component life.

Suggested uses

- Industrial automation applications
- Civil automation applications
- General applications in systems installed using small remote panels

Main features

- The 90...264 Vac and 110...370 Vdc inputs, make it suitable for use on all power supply networks.
- These are Isolation Class 2 power supplies that do not require a grounding connection, which reduces the times and costs of installation in remote panels and surveillance and monitoring systems.
- Their high efficiency reduces energy consumption and operating temperature and allows for use in small housings.
- The large power reserve allows continuous current to be supplied up to at least +50% higher than the rated value, ensuring safety and reliability.
- Short-circuit and overload protection designed to deliver peak currents more than 150% higher than the rated value required by heavy loads.
- Thermal protection prevents failure in cases of prolonged overload at high ambient temperatures.
- Thanks to the high performance and excellent ventilation of internal components, they are greatly reduced in size and have a degree of protection from accidental contacts of IP20 per IEC529.

DOMOTIC POWER



Compact size

Ideal for modular control units and shallow containers

Short-circuit and overload protection

Designed to deliver the typical peak currents required by medium loads

Power boost

The output power supplied reaches up to 130% of the rated value.

High efficiency

Designed to save energy and reduce operating temperature

Input 90...264 Vac and 110...370 Vdc

Appropriate for use on all power supply networks



- Single phase and DC input
- Short circuit, overload, input and output overvoltage protections
- Over temperature protection
- Suitable for standard applications
- Isolation Class 2, no grounding needed



NOTE

Please refer to the datasheet for more details
Above overcurrent limit, the protection starts cycling in ON/OFF mode(hiccup autoreset), the maximum current supplied depends by the line resistance

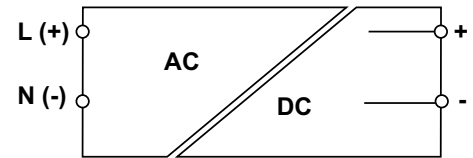
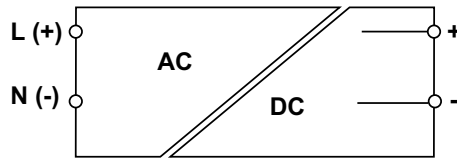

CODE	XCS	DC
TYPE	CSD1-015W/024V/AA	XCS
INPUT TECHNICAL DATA		
Input rated voltage	120–230 Vac	120–230 Vac
Input voltage AC	85...264 Vac	85...264 Vac
Input voltage DC	100...370 Vdc (derating U _{in} <130 Vdc)	100...370 Vdc (derating U _{in} <130 Vdc)
Frequency	47...63 Hz	47...63 Hz
Current consumption	0.29 A (120 Vac) / 0.18 A (230 Vac)	0.29 A (120 Vac) / 0.18 A (230 Vac)
Inrush peak current	5 A	5 A
Power factor	> 0.6	> 0.6
Internal protection fuse	T 1 A	T 1 A
External protection on AC line	MCB: C-2 A / Fuse: T-2 A	MCB: C-2 A / Fuse: T-2 A
OUTPUT TECHNICAL DATA		
Output rated voltage	24 Vdc ±1%	12 Vdc ±1%
Output adjustable range	—	—
Continuous current	0.6 A at 60°C	1.2 A at 60°C
Overload limiting	0.81 A	1.6 A
Short circuit peak current	—	—
Ripple @ nominal ratings	50 mVpp	50 mVpp
Hold up time	12 ms (120 Vac) / 20 ms (230 Vac)	12 ms (120 Vac) / 20 ms (230 Vac)
Status indication	LED "DC OK"	LED "DC OK"
Alarm contact	—	—
Parallel connection	possible	possible
Redundant parallel connection	possible with external ORing diode	possible with external ORing diode
GENERAL TECHNICAL DATA		
Efficiency	86% (120 Vac) / 86% (230 Vac)	84% (120 Vac) / 85% (230 Vac)
Dissipated power	2.2 W (120 Vac) / 2.2 W (230 Vac)	2.7 W (120 Vac) / 2.6 W (230 Vac)
Operating temperature range	-20...+70°C (derating -0.9 W >60°C)	-20...+70°C (derating -0.9 W >60°C)
Input / output isolation	3 kVac / 60 s (SELV output)	3 kVac / 60 s (SELV output)
Input / ground isolation	class 2 without PE connection	class 2 without PE connection
Output / ground isolation	class 2 without PE connection	class 2 without PE connection
Standard / approvals	EN 60950-1, EN 62368-1	EN 60950-1, EN 62368-1
EMC Standards	EN 61000-6-1, EN 61000-6-2, EN 61000-6-3, EN 61000-6-4	EN 61000-6-1, EN 61000-6-2, EN 61000-6-3, EN 61000-6-4
Overvoltage category / Pollution degree	II / 2	II / 2
Protection degree	IP 20	IP 20
Connection terminal IN/OUT	2.5 mm ² / 2.5 mm ²	2.5 mm ² / 2.5 mm ²
Housing material	UL94V-0 plastic material	UL94V-0 plastic material
Dimension	35x62x90 mm	35x62x90 mm
Approximate weight	91 g	91 g
Mounting information	vertical on a rail, 10 mm from adjacent components	vertical on a rail, 10 mm from adjacent components
APPROVALS		
ACCESSORIES		
Mounting rail (IEC60715/TH35-7.5)	PR/3/AC, PR/3/AC/ZB, PR/3/AS, PR/3/AS/ZB	PR/3/AC, PR/3/AC/ZB, PR/3/AS, PR/3/AS/ZB
Mounting rail (IEC60715/TH35-15)	PR/3/PP, PR/3/PP/ZB, PR/3/PA, PR/3/PA/ZB	PR/3/PP, PR/3/PP/ZB, PR/3/PA, PR/3/PA/ZB
Marking tag	—	—

- Single phase and DC input
- Short circuit, overload, input and output overvoltage protections
- Over temperature protection
- Suitable for standard applications
- Isolation Class 2, no grounding needed



NOTE

Please refer to the datasheet for more details
Above overcurrent limit, the protection starts cycling in ON/OFF mode(hiccup autoreset), the maximum current supplied depends by the line resistance

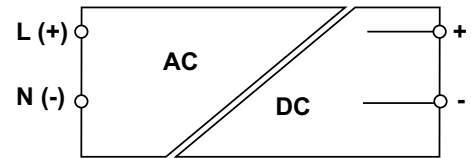
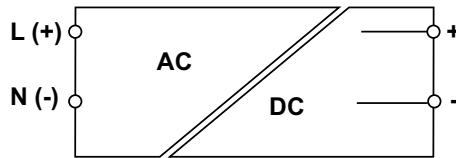

CODE	XCS1030W024VAA	XCS1030W012VAA
TYPE	CSD1-030W/024V/AA	CSD1-030W/012V/AA
INPUT TECHNICAL DATA		
Input rated voltage	120-230 Vac	120-230 Vac
Input voltage AC	85...264 Vac	85...264 Vac
Input voltage DC	100...370 Vdc (derating Uin<130 Vdc)	100...370 Vdc (derating Uin<130 Vdc)
Frequency	47...63 Hz	47...63 Hz
Current consumption	0.56 A (120 Vac) / 0.34 A (230 Vac)	0.56 A (120 Vac) / 0.34 A (230 Vac)
Inrush peak current	5 A	5 A
Power factor	> 0.6	> 0.6
Internal protection fuse	T 2 A	T 2 A
External protection on AC line	MCB: C-3 A / Fuse: T-3 A	MCB: C-3 A / Fuse: T-3 A
OUTPUT TECHNICAL DATA		
Output rated voltage	24 Vdc ±1%	12 Vdc ±1%
Output adjustable range	—	5...15 Vdc
Continuous current	1.25 A at 50°C	4A (5V), 2.9A (10V), 2.5A (12V), 2.0A (15V) at 55°C
Overload limiting	2.0 A	6.9...3.0 A
Short circuit peak current	—	—
Ripple @ nominal ratings	50 mVpp	50 mVpp
Hold up time	12 ms (120 Vac) / 20 ms (230 Vac)	12 ms (120 Vac) / 20 ms (230 Vac)
Status indication	LED "DC OK"	LED "DC OK"
Alarm contact	—	—
Parallel connection	possible	possible
Redundant parallel connection	possible with external ORing diode	possible with external ORing diode
GENERAL TECHNICAL DATA		
Efficiency	88% (120 Vac) / 87% (230 Vac)	87% (120 Vac) / 86% (230 Vac)
Dissipated power	4 W (120 Vac) / 3.9 W (230 Vac)	4.1 W (120 Vac) / 4 W (230 Vac)
Operating temperature range	-20...+70°C (derating -1.2 W >50°C)	-20...+70°C (derating -1.2 W >55°C)
Input / output isolation	3 kVac / 60 s (SELV output)	3 kVac / 60 s (SELV output)
Input / ground isolation	class 2 without PE connection	class 2 without PE connection
Output / ground isolation	class 2 without PE connection	class 2 without PE connection
Standard / approvals	EN 60950-1, EN 62368-1	EN 60950-1, EN 62368-1
EMC Standards	EN 61000-6-1, EN 61000-6-2, EN 61000-6-3, EN 61000-6-4	EN 61000-6-1, EN 61000-6-2, EN 61000-6-3, EN 61000-6-4
Overvoltage category / Pollution degree	II / 2	II / 2
Protection degree	IP 20	IP 20
Connection terminal IN/OUT	2.5 mm ² / 2.5 mm ²	2.5 mm ² / 2.5 mm ²
Housing material	UL94V-0 plastic material	UL94V-0 plastic material
Dimension	53x62x90 mm	53x62x90 mm
Approximate weight	148 g	148 g
Mounting information	vertical on a rail, 10 mm from adjacent components	vertical on a rail, 10 mm from adjacent components
APPROVALS		
ACCESSORIES		
Mounting rail (IEC60715/TH35-7.5)	PR/3/AC, PR/3/AC/ZB, PR/3/AS, PR/3/AS/ZB	PR/3/AC, PR/3/AC/ZB, PR/3/AS, PR/3/AS/ZB
Mounting rail (IEC60715/TH35-15)	PR/3/PP, PR/3/PP/ZB, PR/3/PA, PR/3/PA/ZB	PR/3/PP, PR/3/PP/ZB, PR/3/PA, PR/3/PA/ZB
Marking tag	—	—



- Single phase and DC input
- Short circuit, overload and input overvoltage protection
- Over temperature protection
- Suitable for standard applications
- Isolation Class 2, no grounding needed

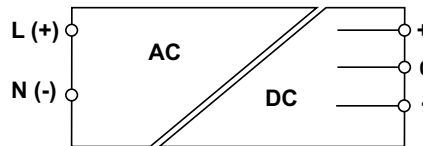

NOTE

Please refer to the datasheet for more details
Above overcurrent limit, the protection starts cycling in ON/OFF mode(hiccup autoreset), the maximum current supplied depends by the line resistance



CODE	XCS30F
TYPE	CSD30F
INPUT TECHNICAL DATA	
Input rated voltage	120–230 Vac
Input voltage AC	90...264 Vac
Input voltage DC	100...345 Vdc (derating Uin<130 Vdc)
Frequency	47...63 Hz
Current consumption	0.4 A (120 Vac) / 0.2 A (230 Vac)
Inrush peak current	13 A
Power factor	> 0.6
Internal protection fuse	T 2 A
External protection on AC line	MCB: C-3 A / Fuse: T-3.15 A
OUTPUT TECHNICAL DATA	
Output rated voltage	±12...±15 Vdc ±1%
Output adjustable range	±12...±15 Vdc
Continuous current	2x 0.6 A at 50°C
Overload limiting	>2x0.8 A
Short circuit peak current	—
Ripple @ nominal ratings	50 mVpp
Hold up time	50 ms (120 Vac) / 100 ms (230 Vac)
Status indication	LED "DC OK"
Alarm contact	—
Parallel connection	possible
Redundant parallel connection	possible with external ORing diode
GENERAL TECHNICAL DATA	
Efficiency	87% (120 Vac) / 89% (230 Vac)
Dissipated power	1.6 W (120 Vac) / 1.3 W (230 Vac)
Operating temperature range	-20...+60°C (derating -0.4 W >55°C)
Input / output isolation	3 kVac / 60 s (SELV output)
Input / ground isolation	class 2 without PE connection
Output / ground isolation	class 2 without PE connection
Standard / approvals	EN 60950-1
EMC Standards	EN 61000-6-1, EN 61000-6-2, EN 61000-6-3, EN 61000-6-4
Overvoltage category / Pollution degree	II / 2
Protection degree	IP 20
Connection terminal IN/OUT	2.5 mm ² / 2.5 mm ²
Housing material	UL94V-0 plastic material
Dimension	71x62x90 mm
Approximate weight	200 g
Mounting information	vertical on a rail, 10 mm from adjacent components
APPROVALS	 
ACCESSORIES	
Mounting rail (IEC60715/TH35-7.5)	PR/3/AC, PR/3/AC/ZB, PR/3/AS, PR/3/AS/ZB
Mounting rail (IEC60715/TH35-15)	PR/3/PP, PR/3/PP/ZB, PR/3/PA, PR/3/PA/ZB
Marking tag	—

- Single phase and DC input
- Short circuit, overload, input and output overvoltage protections
- Over temperature protection
- Suitable for standard applications
- Isolation Class 2, no grounding needed



NOTE

Please refer to the datasheet for more details
Above overcurrent limit, the protection starts cycling in ON/OFF mode(hiccup autoreset), the maximum current supplied depends by the line resistance

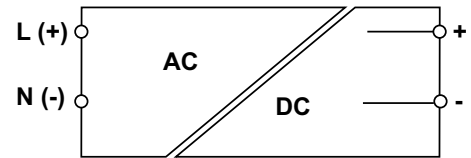
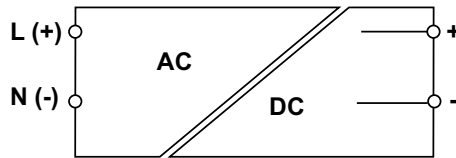

CODE	XCS1072W024VAA	XCS1072W012VAA
TYPE	CSD1-072W/024V/AA	CSD1-072W/012V/AA
INPUT TECHNICAL DATA		
Input rated voltage	120–230 Vac	120–230 Vac
Input voltage AC	85...264 Vac	85...264 Vac
Input voltage DC	100...370 Vdc (derating Uin<130 Vdc)	100...370 Vdc (derating Uin<130 Vdc)
Frequency	47...63 Hz	47...63 Hz
Current consumption	1.17 A (120 Vac) / 0.71 A (230 Vac)	1.17 A (120 Vac) / 0.71 A (230 Vac)
Inrush peak current	15 A	15 A
Power factor	> 0.6	> 0.6
Internal protection fuse	T 2 A	T 2 A
External protection on AC line	MCB: C-3 A / Fuse: T-3 A	MCB: C-3 A / Fuse: T-3 A
OUTPUT TECHNICAL DATA		
Output rated voltage	24 Vdc ±1%	12 Vdc ±1%
Output adjustable range	23.5... 27.5 Vdc	12...15 Vdc
Continuous current	3 A at 55°C	5...4 A at 55°C
Overload limiting	4.5 A	8.0 A
Short circuit peak current	—	—
Ripple @ nominal ratings	50 mVpp	50 mVpp
Hold up time	12 ms (120 Vac) / 20 ms (230 Vac)	12 ms (120 Vac) / 20 ms (230 Vac)
Status indication	LED "DC OK"	LED "DC OK"
Alarm contact	—	—
Parallel connection	possible	possible
Redundant parallel connection	possible with external ORing diode	possible with external ORing diode
GENERAL TECHNICAL DATA		
Efficiency	89% (230 Vac)	89% (230 Vac)
Dissipated power	9.6 W (120 Vac) / 7.9 W (230 Vac)	10 W (120 Vac) / 8.5 W (230 Vac)
Operating temperature range	-20...+70°C (derating -2.6 W >55°C)	-20...+70°C (derating -1.8 W >50°C)
Input / output isolation	3 kVac / 60 s (SELV output)	3 kVac / 60 s (SELV output)
Input / ground isolation	class 2 without PE connection	class 2 without PE connection
Output / ground isolation	class 2 without PE connection	class 2 without PE connection
Standard / approvals	EN 60950-1, EN 62368-1	EN 60950-1, EN 62368-1
EMC Standards	EN 61000-6-1, EN 61000-6-2, EN 61000-6-3, EN 61000-6-4	EN 61000-6-1, EN 61000-6-2, EN 61000-6-3, EN 61000-6-4
Overvoltage category / Pollution degree	II / 2	II / 2
Protection degree	IP 20	IP 20
Connection terminal IN/OUT	2.5 mm ² / 2.5 mm ²	2.5 mm ² / 2.5 mm ²
Housing material	UL94V-0 plastic material	UL94V-0 plastic material
Dimension	71x62x90 mm	71x62x90 mm
Approximate weight	229 g	229 g
Mounting information	vertical on a rail, 10 mm from adjacent components	vertical on a rail, 10 mm from adjacent components
APPROVALS		
ACCESSORIES		
Mounting rail (IEC60715/TH35-7.5)	PR/3/AC, PR/3/AC/ZB, PR/3/AS, PR/3/AS/ZB	PR/3/AC, PR/3/AC/ZB, PR/3/AS, PR/3/AS/ZB
Mounting rail (IEC60715/TH35-15)	PR/3/PP, PR/3/PP/ZB, PR/3/PA, PR/3/PA/ZB	PR/3/PP, PR/3/PP/ZB, PR/3/PA, PR/3/PA/ZB
Marking tag	—	—

Single-phase switching power supply with DIN-rail, designed specifically for applications in command and control panels for industrial automation and process control. Capable of delivering +60% to +80% nominal current for a prolonged period of time while maintaining a constant output voltage and equipped with a voltage threshold-controlled failure contact which is triggered when the voltage drops below 90% of the rated value. **With these features and numerous international certifications, this range of power supplies enables designers to meet the requirements of the Machinery Directive EN 60204-1**, allowing the protection devices connected to the output to trigger quickly, safely and selectively, thus ensuring continuity of service to the other parts of the system.

Suggested uses

- Applications in industrial automation with high performance and reliability requirements.
- Applications which require selectable overcurrent protections on DC lines
- Applications in machine automation with high command and control voltage reliability and safety requirements
- Applications in process control
- Uses with heavy loads
- Civil automation applications

Main features

- The 90...264 Vac and 110...370 Vdc inputs, make it suitable for use on all power supply networks.
- Threshold failure contact which is triggered when the voltage falls below 90% of the rated value.
- Versions with integrated ORing diode for redundant parallel connection, preventing the need for external devices and reducing bulk and installation costs.
- High efficiency reduces energy consumption and the operating temperature of components and allows use in small panels and severe environmental conditions.
- Large power reserve allows for delivery of at least +60-80% nominal current and voltage for several minutes, ensuring safety and reliability.
- Output voltage is adjustable and the output is protected against input surge from the DC line generated from inductive loads.
- The output is equipped with dual electronic protection which prevents dangerous voltages for powered components in the event of an internal fault.
- Thermal protection prevents faults in case of prolonged overload with high ambient temperatures.
- Construction ensures excellent ventilation capacity of internal components, with reduced sizes and a degree of protection from accidental contacts of IP20 per IEC529.
- Thanks to their high performance and excellent ventilation capacity, they are among the smallest on the market.

COOL POWER

48Vdc and 72-85Vdc models have been introduced, designed to reliably power engines in DC. They:

- supply peak power equal to even 4-5 times the nominal current, which is required by the engine during the peak phase
- have an output stage protected from overvoltage generated by the engines and drives during braking, which could otherwise cause malfunctions or cause the power supply to lose control over output voltage stability.

Extremely compact dimensions

Among the smallest on the market, optimising the use of space in the panel without compromising performance

Power boost

The output power reaches 120% of the nominal value for several minutes, up to 160% in the event of overload, and up to 300% during a short-circuit, to enable the protection devices connected to the output to trigger quickly, safely and selectively, without the use of additional modules.

Short-circuit and overload protection

Designed to deliver the strong peak currents required by heavy loads

High efficiency

Designed to save energy and reduce operating temperature

Input 90...264 Vac and 110...370 Vdc

Appropriate for use on all single-phase power supply networks

Intelligent failure contact

Notifies when the output voltage falls below 90% of the rated value once a threshold is surpassed

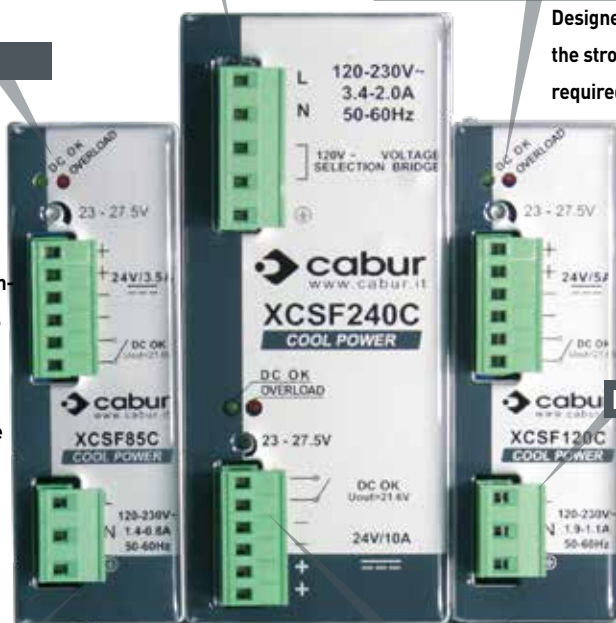





- Single phase and DC input
- Short circuit, overload and input overvoltage protection
- Compact dimension
- Suitable for standard applications
- Isolation Class 2, no grounding needed

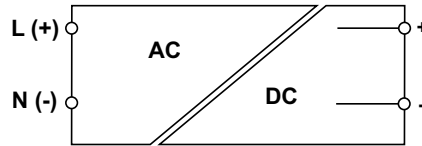

NOTE

Please refer to the datasheet for more details
Above overcurrent limit, the protection starts cycling in ON/OFF mode(hiccup autoreset), the maximum current supplied depends by the line resistance
Produced on demand, contact our sales office for availability



CODE	XCSF30C
TYPE	CSF30C
INPUT TECHNICAL DATA	
Input rated voltage	120–230 Vac
Input voltage AC	90...264 Vac
Input voltage DC	100...320 Vdc (derating Uin<130 Vdc)
Frequency	47...63 Hz
Current consumption	0.55 A (120 Vac) / 0.3 A (230 Vac)
Inrush peak current	25 A
Power factor	> 0.6
Internal protection fuse	T 1.25 A
External protection on AC line	MCB: C-2 A / Fuse: T-2 A
OUTPUT TECHNICAL DATA	
Output rated voltage	24 Vdc ±1%
Output adjustable range	—
Continuous current	1.2 A at 50°C
Overload limiting	1.4 A
Short circuit peak current	—
Ripple @ nominal ratings	50 mVpp
Hold up time	10 ms (120 Vac) / 30 ms (230 Vac)
Status indication	LED "DC OK"
Alarm contact	—
Parallel connection	possible
Redundant parallel connection	possible with external ORing diode
GENERAL TECHNICAL DATA	
Efficiency	86% (120 Vac) / 87% (230 Vac)
Dissipated power	4.7 W (120 Vac) / 4.3 W (230 Vac)
Operating temperature range	-20...+60°C (derating -0.75 W >50°C)
Input / output isolation	3 kVac / 60 s (SELV output)
Input / ground isolation	class 2 without PE connection
Output / ground isolation	class 2 without PE connection
Standard / approvals	EN 60950-1
EMC Standards	EN 61000-6-2, EN 61000-6-4
Overvoltage category / Pollution degree	II / 2
Protection degree	IP 20
Connection terminal IN/OUT	2.5 mm ² / 2.5 mm ²
Housing material	UL94V-0 plastic material
Dimension	23x99x82 mm
Approximate weight	140 g
Mounting information	vertical on a rail, 10 mm from adjacent components
APPROVALS	   
ACCESSORIES	
Mounting rail (IEC60715/TH35-7.5)	PR/3/AC, PR/3/AC/ZB, PR/3/AS, PR/3/AS/ZB
Mounting rail (IEC60715/TH35-15)	—
Marking tag	—

- Single phase and DC input
- Short circuit, overload, input and output overvoltage protections
- Over temperature protection
- Suitable for applications that require high reliability and performance
- Smart alarm contact, signals when output voltage drops more than 10%
- High overload capability to ensure the protections selectivity and start-up of heavy loads



NOTE
Please refer to the datasheet for more details
Above overcurrent limit, the protection starts cycling in ON/OFF mode(hiccup autoreset), the maximum current supplied depends by the line resistance

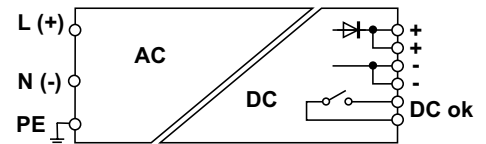
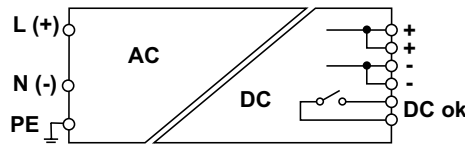

CODE	XCSF85C	XCSF85CP
TYPE	CSF85C	CSF85CP
INPUT TECHNICAL DATA		
Input rated voltage	120–230 Vac	120–230 Vac
Input voltage AC	90...264 Vac	90...264 Vac
Input voltage DC	100...345 Vdc [derating Uin<130 Vdc]	100...345 Vdc [derating Uin<130 Vdc]
Frequency	47...63 Hz	47...63 Hz
Current consumption	1.6 A (120 Vac) / 0.9 A (230 Vac)	1.6 A (120 Vac) / 0.9 A (230 Vac)
Inrush peak current	20 A	20 A
Power factor	> 0.65	> 0.65
Internal protection fuse	T 2 A	T 2 A
External protection on AC line	MCB: C-4 A / Fuse: T 4 A	MCB: C-4 A / Fuse: T 4 A
OUTPUT TECHNICAL DATA		
Output rated voltage	24 Vdc ±1%	24 Vdc ±1%
Output adjustable range	23...27.5 Vdc	23...27.5 Vdc
Continuous current	3.5 A at 50°C	3.5 A at 50°C
Overload limiting	6 A for >30 s	6 A for >30 s
Short circuit peak current	10 A for 50 ms	10 A for 50 ms
Ripple @ nominal ratings	70 mVpp	70 mVpp
Hold up time	20 ms (120 Vac) / 70 ms (230 Vac)	20 ms (120 Vac) / 70 ms (230 Vac)
Status indication	LED "DC OK" / LED "Alarm"	LED "DC OK" / LED "Alarm"
Alarm contact	dry contact, max. 1A @ 24 Vdc (Uout >21.6 Vdc)	dry contact, max. 1A @ 24 Vdc (Uout >21.6 Vdc)
Parallel connection	possible	possible
Redundant parallel connection	possible with external ORing diode	already fitted with internal ORing diode
GENERAL TECHNICAL DATA		
Efficiency	86% (120 Vac) / 90% (230 Vac)	86% (120 Vac) / 90% (230 Vac)
Dissipated power	14 W (120 Vac) / 10 W (230 Vac)	14 W (120 Vac) / 10 W (230 Vac)
Operating temperature range	-20...+60°C (derating -1.45 W >45°C)	-20...+60°C (derating -1.45 W >45°C)
Input / output isolation	3 kVac / 60 s (SELV output)	3 kVac / 60 s (SELV output)
Input / ground isolation	1.5 kVac / 60 s	1.5 kVac / 60 s
Output / ground isolation	0.5 kVac / 60 s	0.5 kVac / 60 s
Standard / approvals	EN 60950-1	EN 60950-1
EMC Standards	EN 61000-6-1, EN 61000-6-2, EN 61000-6-3, EN 61000-6-4	EN 61000-6-1, EN 61000-6-2, EN 61000-6-3, EN 61000-6-4
Overvoltage category / Pollution degree	II / 2	II / 2
Protection degree	IP 20	IP 20
Connection terminal IN/OUT	2.5 mm ² / 2.5 mm ²	2.5 mm ² / 2.5 mm ²
Housing material	aluminium	aluminium
Dimension	40x130x115 mm	40x130x115 mm
Approximate weight	400 g	400 g
Mounting information	vertical on a rail, 10 mm from adjacent components	vertical on a rail, 10 mm from adjacent components
APPROVALS		
ACCESSORIES		
Mounting rail (IEC60715/TH35-7.5)	PR/3/AC, PR/3/AC/ZB, PR/3/AS, PR/3/AS/ZB	PR/3/AC, PR/3/AC/ZB, PR/3/AS, PR/3/AS/ZB
Mounting rail (IEC60715/TH35-15)	PR/3/PP, PR/3/PP/ZB, PR/3/PA, PR/3/PA/ZB	PR/3/PP, PR/3/PP/ZB, PR/3/PA, PR/3/PA/ZB
Marking tag	–	–





- Single phase and DC input
- Short circuit, overload, input and output overvoltage protections
- Over temperature protection
- Suitable for applications that require high reliability and performance
- Smart alarm contact, signals when output voltage drops more than 10%
- High overload capability to ensure the protections selectivity and start-up of heavy loads

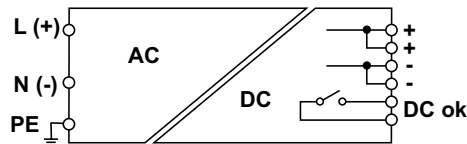

NOTE

Please refer to the datasheet for more details
Above overcurrent limit, the protection starts cycling in ON/OFF mode(hiccup autoreset), the maximum current supplied depends by the line resistance



CODE	XCSF85B
TYPE	CSF85B
INPUT TECHNICAL DATA	
Input rated voltage	120–230 Vac
Input voltage AC	90...264 Vac
Input voltage DC	100...345 Vdc (derating U _{in} <130 Vdc)
Frequency	47...63 Hz
Current consumption	1.6 A (120 Vac) / 0.9 A (230 Vac)
Inrush peak current	20 A
Power factor	> 0.65
Internal protection fuse	T 2 A
External protection on AC line	MCB: C-4 A / Fuse: T 4 A
OUTPUT TECHNICAL DATA	
Output rated voltage	12 Vdc ±1%
Output adjustable range	12...15 Vdc
Continuous current	6 A at 50°C
Overload limiting	9A for >30 s
Short circuit peak current	10 A for 50 ms
Ripple @ nominal ratings	30 mVpp
Hold up time	15 ms (120 Vac) / 60 ms (230 Vac)
Status indication	LED "DC OK" / LED "Alarm"
Alarm contact	dry contact, max. 1A @ 24 Vdc (U _{out} > 10.8 Vdc)
Parallel connection	possible
Redundant parallel connection	possible with external ORing diode
GENERAL TECHNICAL DATA	
Efficiency	83% (120 Vac) / 87% (230 Vac)
Dissipated power	17 W (120 Vac) / 13 W (230 Vac)
Operating temperature range	-20...+60°C (derating -1.45 W >45°C)
Input / output isolation	3 kVac / 60 s (SELV output)
Input / ground isolation	1.5 kVac / 60 s
Output / ground isolation	0.5 kVac / 60 s
Standard / approvals	EN 60950-1
EMC Standards	EN 61000-6-1, EN 61000-6-2, EN 61000-6-3, EN 61000-6-4
Overvoltage category / Pollution degree	II / 2
Protection degree	IP 20
Connection terminal IN/OUT	2.5 mm ² / 2.5 mm ²
Housing material	aluminium
Dimension	40x130x115 mm
Approximate weight	400 g
Mounting information	vertical on a rail, 10 mm from adjacent components
APPROVALS	   
ACCESSORIES	
Mounting rail (IEC60715/TH35-7.5)	PR/3/AC, PR/3/AC/ZB, PR/3/AS, PR/3/AS/ZB
Mounting rail (IEC60715/TH35-15)	PR/3/PP, PR/3/PP/ZB, PR/3/PA, PR/3/PA/ZB
Marking tag	–

- Single phase and DC input
- Short circuit, overload, input and output overvoltage protections
- Over temperature protection
- Suitable for applications that require high reliability and performance
- Smart alarm contact, signals when output voltage drops more than 10%
- High overload capability to ensure the protections selectivity and start-up of heavy loads



NOTE

Please refer to the datasheet for more details
Above overcurrent limit, the protection starts cycling in ON/OFF mode(hiccup autoreset), the maximum current supplied depends by the line resistance

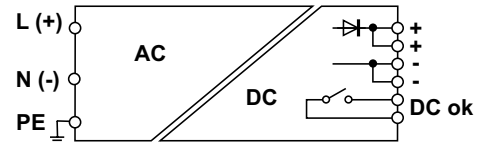
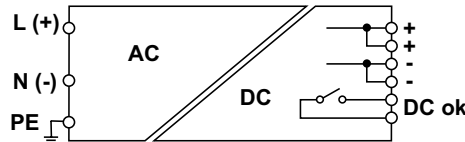

CODE	XCSF120C	XCSF120CP
TYPE	CSF120C	CSF120CP
INPUT TECHNICAL DATA		
Input rated voltage	120–230 Vac	120–230 Vac
Input voltage AC	90...264 Vac	90...264 Vac
Input voltage DC	100...345 Vdc [derating Uin<130 Vdc]	100...345 Vdc [derating Uin<130 Vdc]
Frequency	47...63 Hz	47...63 Hz
Current consumption	1.9 A (120 Vac) / 1.1 A (230 Vac)	1.9 A (120 Vac) / 1.1 A (230 Vac)
Inrush peak current	20 A	20 A
Power factor	> 0.65	> 0.65
Internal protection fuse	T 3.15 A	T 3.15 A
External protection on AC line	MCB: C-4 A / Fuse: T 4 A	MCB: C-4 A / Fuse: T 4 A
OUTPUT TECHNICAL DATA		
Output rated voltage	24 Vdc ±1%	24 Vdc ±1%
Output adjustable range	23...27.5 Vdc	23...27.5 Vdc
Continuous current	5 A at 45°C	5 A at 45°C
Overload limiting	8 A for >30 s	8 A for >30 s
Short circuit peak current	15 A for 50 ms	15 A for 50 ms
Ripple @ nominal ratings	30 mVpp	30 mVpp
Hold up time	17 ms (120 Vac) / 72 ms (230 Vac)	17 ms (120 Vac) / 72 ms (230 Vac)
Status indication	LED "DC OK" / LED "Alarm"	LED "DC OK" / LED "Alarm"
Alarm contact	dry contact, max. 1A @ 24 Vdc (Uout >21.6 Vdc)	dry contact, max. 1A @ 24 Vdc (Uout >21.6 Vdc)
Parallel connection	possible	possible
Redundant parallel connection	possible with external ORing diode	already fitted with internal ORing diode
GENERAL TECHNICAL DATA		
Efficiency	86% (120 Vac) / 90% (230 Vac)	86% (120 Vac) / 90% (230 Vac)
Dissipated power	19 W (120 Vac) / 13 W (230 Vac)	19 W (120 Vac) / 13 W (230 Vac)
Operating temperature range	-20...+60°C (derating -1.9 W >45°C)	-20...+60°C (derating -1.9 W >45°C)
Input / output isolation	3 kVac / 60 s (SELV output)	3 kVac / 60 s (SELV output)
Input / ground isolation	1.5 kVac / 60 s	1.5 kVac / 60 s
Output / ground isolation	0.5 kVac / 60 s	0.5 kVac / 60 s
Standard / approvals	EN 60950-1	EN 60950-1
EMC Standards	EN 61000-6-1, EN 61000-6-2, EN 61000-6-3, EN 61000-6-4	EN 61000-6-1, EN 61000-6-2, EN 61000-6-3, EN 61000-6-4
Overvoltage category / Pollution degree	II / 2	II / 2
Protection degree	IP 20	IP 20
Connection terminal IN/OUT	2.5 mm ² / 2.5 mm ²	2.5 mm ² / 2.5 mm ²
Housing material	aluminium	aluminium
Dimension	40x130x115 mm	40x130x115 mm
Approximate weight	400 g	400 g
Mounting information	vertical on a rail, 10 mm from adjacent components	vertical on a rail, 10 mm from adjacent components
APPROVALS		
ACCESSORIES		
Mounting rail (IEC60715/TH35-7.5)	PR/3/AC, PR/3/AC/ZB, PR/3/AS, PR/3/AS/ZB	PR/3/AC, PR/3/AC/ZB, PR/3/AS, PR/3/AS/ZB
Mounting rail (IEC60715/TH35-15)	PR/3/PP, PR/3/PP/ZB, PR/3/PA, PR/3/PA/ZB	PR/3/PP, PR/3/PP/ZB, PR/3/PA, PR/3/PA/ZB
Marking tag	–	–

- Single phase and DC input
- Short circuit, overload, input and output overvoltage protections
- Over temperature protection
- Suitable for applications that require high reliability and performance
- Smart alarm contact, signals when output voltage drops more than 10%
- High overload capability to ensure the protections selectivity and start-up of heavy loads



NOTE

Please refer to the datasheet for more details
Above overcurrent limit, the protection starts cycling in ON/OFF mode(hiccup autoreset), the maximum current supplied depends by the line resistance

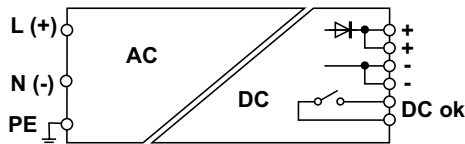

CODE	XCSF120DP
TYPE	CSF120DP
INPUT TECHNICAL DATA	
Input rated voltage	120–230 Vac
Input voltage AC	90...264 Vac
Input voltage DC	100...345 Vdc (derating Uin<130 Vdc)
Frequency	47...63 Hz
Current consumption	1.9 A (120 Vac) / 1.1 A (230 Vac)
Inrush peak current	20 A
Power factor	> 0.65
Internal protection fuse	T 3.15 A
External protection on AC line	MCB: C-4 A / Fuse: T 4 A
OUTPUT TECHNICAL DATA	
Output rated voltage	48 Vdc ±1%
Output adjustable range	45...55 Vdc
Continuous current	2.5 A at 45°C
Overload limiting	8 A for >30 s
Short circuit peak current	7.5 A for 50 ms
Ripple @ nominal ratings	30 mVpp
Hold up time	16 ms (120 Vac) / 81 ms (230 Vac)
Status indication	LED "DC OK" / LED "Alarm"
Alarm contact	dry contact, max. 1A @ 24 Vdc (Uout >43.2 Vdc)
Parallel connection	possible
Redundant parallel connection	already fitted with internal ORing diode
GENERAL TECHNICAL DATA	
Efficiency	86% (120 Vac) / 90% (230 Vac)
Dissipated power	20 W (120 Vac) / 13 W (230 Vac)
Operating temperature range	-20...+60°C (derating -2.4 W >45°C)
Input / output isolation	3 kVac / 60 s (SELV output)
Input / ground isolation	1.5 kVac / 60 s
Output / ground isolation	0.5 kVac / 60 s
Standard / approvals	EN 60950-1
EMC Standards	EN 61000-6-1, EN 61000-6-2, EN 61000-6-3, EN 61000-6-4
Overvoltage category / Pollution degree	II / 2
Protection degree	IP 20
Connection terminal IN/OUT	2.5 mm ² / 2.5 mm ²
Housing material	aluminium
Dimension	40x130x115 mm
Approximate weight	400 g
Mounting information	vertical on a rail, 10 mm from adjacent components
APPROVALS	
ACCESSORIES	
Mounting rail (IEC60715/TH35-7.5)	PR/3/AC, PR/3/AC/ZB, PR/3/AS, PR/3/AS/ZB
Mounting rail (IEC60715/TH35-15)	PR/3/PP, PR/3/PP/ZB, PR/3/PA, PR/3/PA/ZB
Marking tag	–

- Single phase input
- Short circuit, overload, input and output overvoltage protections
- Over temperature protection
- Suitable for applications that require high reliability and performance
- Smart alarm contact, signals when output voltage drops more than 10%
- High overload capability to ensure the protections selectivity and start-up of heavy loads



POWER

NOTE
Please refer to the datasheet for more details
Above overcurrent limit, the protection starts cycling in ON/OFF mode(hiccup autoreset), the maximum current supplied depends by the line resistance
(1) Dual voltage with selection through external jumper

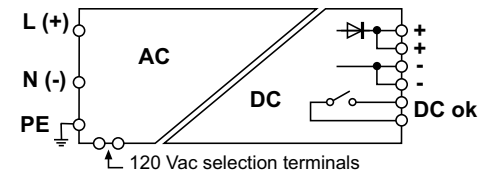
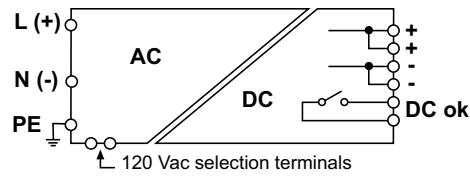

CODE	XCSF240C	XCSF240CP
TYPE	CSF240C	CSF240CP
INPUT TECHNICAL DATA		
Input rated voltage	120–230 Vac	120–230 Vac
Input voltage AC	90...132 Vac / 185...264 Vac (1)	90...132 Vac / 185...264 Vac (1)
Input voltage DC	300...345 Vdc	300...345 Vdc
Frequency	47...63 Hz	47...63 Hz
Current consumption	3.5 A (120 Vac) / 1.8 A (230 Vac)	3.5 A (120 Vac) / 1.8 A (230 Vac)
Inrush peak current	35 A	35 A
Power factor	> 0.6	> 0.6
Internal protection fuse	T 6.3 A	T 6.3 A
External protection on AC line	MCB: C-10 A / Fuse: T 10 A	MCB: C-10 A / Fuse: T 10 A
OUTPUT TECHNICAL DATA		
Output rated voltage	24 Vdc ±1%	24 Vdc ±1%
Output adjustable range	23...27.5 Vdc	23...27.5 Vdc
Continuous current	10 A at 45°C	10 A at 45°C
Overload limiting	15 A for >30 s	15 A for >30 s
Short circuit peak current	25 A for 400 ms	25 A for 400 ms
Ripple @ nominal ratings	50 mVpp	50 mVpp
Hold up time	30 ms (120 Vac) / 60 ms (230 Vac)	30 ms (120 Vac) / 60 ms (230 Vac)
Status indication	LED "DC OK" / LED "Alarm"	LED "DC OK" / LED "Alarm"
Alarm contact	dry contact, max. 1A @ 24 Vdc (Uout >21.6 Vdc)	dry contact, max. 1A @ 24 Vdc (Uout >21.6 Vdc)
Parallel connection	possible	possible
Redundant parallel connection	possible with external ORing diode	already fitted with internal ORing diode
GENERAL TECHNICAL DATA		
Efficiency	88% (120 Vac) / 90% (230 Vac)	88% (120 Vac) / 90% (230 Vac)
Dissipated power	32 W (120 Vac) / 27 W (230 Vac)	32 W (120 Vac) / 27 W (230 Vac)
Operating temperature range	-20...+60°C (derating -4 W >45°C)	-20...+60°C (derating -4 W >45°C)
Input / output isolation	3 kVac / 60 s (SELV output)	3 kVac / 60 s (SELV output)
Input / ground isolation	1.5 kVac / 60 s	1.5 kVac / 60 s
Output / ground isolation	0.5 kVac / 60 s	0.5 kVac / 60 s
Standard / approvals	EN 60950-1	EN 60950-1
EMC Standards	EN 61000-6-1, EN 61000-6-2, EN 61000-6-3, EN 61000-6-4	EN 61000-6-1, EN 61000-6-2, EN 61000-6-3, EN 61000-6-4
Overvoltage category / Pollution degree	II / 2	II / 2
Protection degree	IP 20	IP 20
Connection terminal IN/OUT	2.5 mm ² / 2.5 mm ²	2.5 mm ² / 2.5 mm ²
Housing material	aluminium	aluminium
Dimension	63.5x135x140 mm	63.5x135x140 mm
Approximate weight	920 g	920 g
Mounting information	vertical on a rail, 10 mm from adjacent components	vertical on a rail, 10 mm from adjacent components
APPROVALS		
ACCESSORIES		
Mounting rail (IEC60715/TH35-7.5)	PR/3/AC, PR/3/AC/ZB, PR/3/AS, PR/3/AS/ZB	PR/3/AC, PR/3/AC/ZB, PR/3/AS, PR/3/AS/ZB
Mounting rail (IEC60715/TH35-15)	PR/3/PP, PR/3/PP/ZB, PR/3/PA, PR/3/PA/ZB	PR/3/PP, PR/3/PP/ZB, PR/3/PA, PR/3/PA/ZB
Marking tag	–	–

- Single phase input
- Short circuit, overload, input and output overvoltage protections
- Over temperature protection
- Suitable for applications that require high reliability and performance
- Smart alarm contact, signals when output voltage drops more than 10%
- High overload capability to ensure the protections selectivity and start-up of heavy loads



NOTE
Please refer to the datasheet for more details
Above overcurrent limit, the protection starts cycling in ON/OFF mode(hiccup autoreset), the maximum current supplied depends by the line resistance
(1) Dual voltage with selection through external jumper

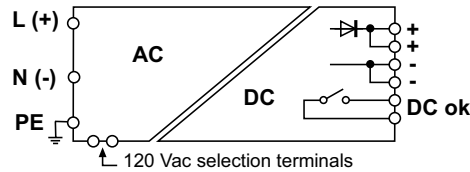

CODE	XCSF240DP
TYPE	CSF240DP
INPUT TECHNICAL DATA	
Input rated voltage	120–230 Vac
Input voltage AC	90...132 Vac / 185...264 Vac (1)
Input voltage DC	300...345 Vdc
Frequency	47...63 Hz
Current consumption	3.5 A (120 Vac) / 1.8 A (230 Vac)
Inrush peak current	35 A
Power factor	> 0.6
Internal protection fuse	T 6.3 A
External protection on AC line	MCB: C-10 A / Fuse: T 10 A
OUTPUT TECHNICAL DATA	
Output rated voltage	48 Vdc ±1%
Output adjustable range	45...55 Vdc
Continuous current	5 A at 45°C
Overload limiting	7.5 A for >30 s
Short circuit peak current	25 A for 400 ms
Ripple @ nominal ratings	50 mVpp
Hold up time	30 ms (120 Vac) / 60 ms (230 Vac)
Status indication	LED "DC OK" / LED "Alarm"
Alarm contact	dry contact, max. 1A @ 24 Vdc (Uout >43.2 Vdc)
Parallel connection	possible
Redundant parallel connection	already fitted with internal ORing diode
GENERAL TECHNICAL DATA	
Efficiency	89% (120 Vac) / 89% (230 Vac)
Dissipated power	28 W (120 Vac) / 28 W (230 Vac)
Operating temperature range	-20...+60°C (derating -4 W >45°C)
Input / output isolation	3 kVac / 60 s (SELV output)
Input / ground isolation	1.5 kVac / 60 s
Output / ground isolation	0.5 kVac / 60 s
Standard / approvals	EN 60950-1
EMC Standards	EN 61000-6-1, EN 61000-6-2, EN 61000-6-3, EN 61000-6-4
Overvoltage category / Pollution degree	II / 2
Protection degree	IP 20
Connection terminal IN/OUT	2.5 mm ² / 2.5 mm ²
Housing material	aluminium
Dimension	63.5x135x140 mm
Approximate weight	920 g
Mounting information	vertical on a rail, 10 mm from adjacent components
APPROVALS	
ACCESSORIES	
Mounting rail (IEC60715/TH35-7.5)	PR/3/AC, PR/3/AC/ZB, PR/3/AS, PR/3/AS/ZB
Mounting rail (IEC60715/TH35-15)	PR/3/PP, PR/3/PP/ZB, PR/3/PA, PR/3/PA/ZB
Marking tag	–

- Single phase input
- Short circuit, overload, input and output overvoltage protections
- Over temperature protection
- Suitable for applications that require high reliability and performance
- Smart alarm contact, signals when output voltage drops more than 10%
- High overload capability to ensure the protections selectivity and start-up of heavy loads



NOTE

Please refer to the datasheet for more details
Above overcurrent limit, the protection starts cycling in ON/OFF mode(hiccup autoreset), the maximum current supplied depends by the line resistance
(1) Dual voltage with selection through external jumper

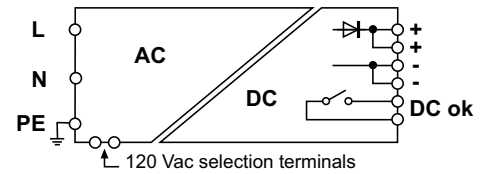
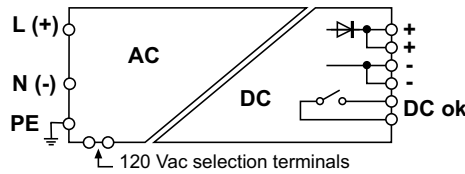

CODE	XCSF500C	XCSF500D
TYPE	CSF500C	CSF500D
INPUT TECHNICAL DATA		
Input rated voltage	120-230 Vac	120-230 Vac
Input voltage AC	90...132 Vac / 185...264 Vac (1)	90...132 Vac / 185...264 Vac (1)
Input voltage DC	259-370 Vdc (derating Uin<130 Vdc)	259-370 Vdc (derating Uin<130 Vdc)
Frequency	47...63 Hz	47...63 Hz
Current consumption	8.4 A (120Vac) / 4.4 A (230Vac)	8.4 A (120Vac) / 4.4 A (230Vac)
Inrush peak current	25 A with electronic limiter	25 A with electronic limiter
Power factor	> 0.75	> 0.75
Internal protection fuse	—	—
External protection on AC line	MCB: C-16 A / Fuse: T 15 A	MCB: C-16 A / Fuse: T 15 A
OUTPUT TECHNICAL DATA		
Output rated voltage	24 Vdc ±1%	48 Vdc ±1%
Output adjustable range	24...28 Vdc	45...55 Vdc
Continuous current	20 A at 45°C	10 A at 45°C
Overload limiting	22 A for >5 s	12 A for >5 s
Short circuit peak current	35 A for 5 s	20 A for 5 s
Ripple @ nominal ratings	50 mVpp	50 mVpp
Hold up time	12 ms (120 Vac) / 20 ms (230 Vac)	12 ms (120 Vac) / 20 ms (230 Vac)
Status indication	LED "DC OK" / LED "Alarm"	LED "DC OK" / LED "Alarm"
Alarm contact	dry contact, max. 1A @ 24 Vdc (Uout >21.6 Vdc)	dry contact, max. 1A @ 24 Vdc (Uout >43.2 Vdc)
Parallel connection	possible	possible
Redundant parallel connection	already fitted with internal ORing diode	already fitted with internal ORing diode
GENERAL TECHNICAL DATA		
Efficiency	92% (120 Vac) / 92% (230 Vac)	92% (120 Vac) / 92% (230 Vac)
Dissipated power	44 W (120 Vac) / 44 W (230 Vac)	44 W (120 Vac) / 44 W (230 Vac)
Operating temperature range	-20...+60°C (derating -8.2 W >45°C)	-20...+60°C (derating -8.2 W >45°C)
Input / output isolation	3 kVac / 60 s (SELV output)	3 kVac / 60 s (SELV output)
Input / ground isolation	1.5 kVac / 60 s	1.5 kVac / 60 s
Output / ground isolation	0.5 kVac / 60 s	0.5 kVac / 60 s
Standard / approvals	EN 60950-1	EN 60950-1
EMC Standards	EN 61000-6-1, EN 61000-6-2, EN 61000-6-3, EN 61000-6-4	EN 61000-6-1, EN 61000-6-2, EN 61000-6-3, EN 61000-6-4
Overvoltage category / Pollution degree	II / 2	II / 2
Protection degree	IP 20	IP 20
Connection terminal IN/OUT	4 mm ² / 4 mm ²	4 mm ² / 4 mm ²
Housing material	aluminium	aluminium
Dimension	80x139x127 mm	80x139x127 mm
Approximate weight	1.3 kg	1.3 kg
Mounting information	vertical on a rail, 10 mm from adjacent components	vertical on a rail, 10 mm from adjacent components
APPROVALS		
ACCESSORIES		
Mounting rail (IEC60715/TH35-7.5)	PR/3/AC, PR/3/AC/ZB, PR/3/AS, PR/3/AS/ZB	PR/3/AC, PR/3/AC/ZB, PR/3/AS, PR/3/AS/ZB
Mounting rail (IEC60715/TH35-15)	PR/3/PP, PR/3/PP/ZB, PR/3/PA, PR/3/PA/ZB	PR/3/PP, PR/3/PP/ZB, PR/3/PA, PR/3/PA/ZB
Marking tag	TAP207A, TAP128A, TAP178A, TAP209A	TAP207A, TAP128A, TAP178A, TAP209A

Switching power supply for DIN-rail, for general applications in automation and installation. Offering excellent value for money, these offer a perfect and convenient solution for uses in which the powered loads do not require strong peak currents. They can deliver over +30% of nominal current for a sustained period, keeping the output voltage stable and ensuring continuity of supply to the system. **With these features, this range of power supplies enables designers to meet the requirements of the Machinery Directive EN 60204-1**, allowing the protection devices connected to the output to trigger quickly, safely and selectively, thus ensuring continuity of service to the other parts of the system.

Suggested uses

- Civil automation applications
- General applications in plant installations

Main features

- High efficiency reduces energy consumption and the operating temperature of components and allows use in small panels and severe environmental conditions.
- Power reserve +20-30% of nominal current, ensuring safety and reliability.
- Output voltage is adjustable and protected against incoming surge generated by inductive loads on the DC line, and is equipped with a double electronic protection that prevents the powered device from failing in case of an internal malfunction.
- Short-circuit, overload and thermal protection prevents faults in case of prolonged overload with high ambient temperatures.
- Construction ensures optimal capacity of ventilation of internal components, extremely reduced overall dimensions and degree of protection IP20 by accidental contact according to IEC529.
- Offer superior performance, features and reliability compared to other products of a similar power and cost.

EASY POWER



Short-circuit, overload and thermal protection
Prevents faults in case of prolonged overload with high ambient temperatures

Adjustable output voltage Protected
against incoming surge generated by inductive loads on the DC line

Power boost
The output power reaches 130% in the event of overload, and up to 150% during a short-circuit



Extremely compact dimensions
Among the smallest on the market, optimising the use of space in the panel without compromising performance

High performance
Reduces the energy consumption and operating temperature of components and allows for use in small panels and in severe ambient conditions

- Single phase and DC input
- Short circuit, overload, input and output overvoltage protections
- Over temperature protection
- Suitable for standard applications
- Alarm contact



NOTE

Please refer to the datasheet for more details
Above overcurrent limit, the protection starts cycling in ON/OFF mode(hiccup autoreset), the maximum current supplied depends by the line resistance

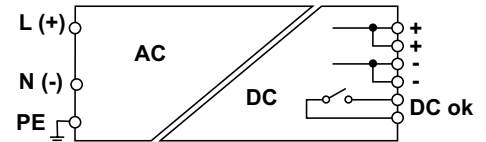
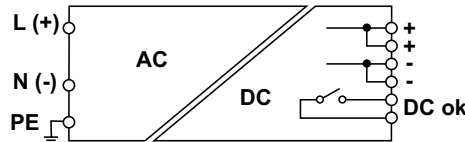

CODE	XCSL1072W024VAA	XCSL1120W024VAA
TYPE	CSL1-072W/024V/AA	CSL1-120W/024V/AA
INPUT TECHNICAL DATA		
Input rated voltage	120–230 Vac	120–230 Vac
Input voltage AC	85...264 Vac	85...264 Vac
Input voltage DC	100...370 Vdc (derating Uin<130 Vdc)	100...370 Vdc (derating Uin<130 Vdc)
Frequency	47...63 Hz	47...63 Hz
Current consumption	0.7 A (120 Vac) / 0.4 A (230 Vac)	1.8 A (120 Vac) / 1.1 A (230 Vac)
Inrush peak current	20 A	20 A
Power factor	> 0.65	> 0.65
Internal protection fuse	T 2 A	T 3.15 A
External protection on AC line	MCB: C-4 A / Fuse: T-4 A	MCB: C-4 A / Fuse: T-4 A
OUTPUT TECHNICAL DATA		
Output rated voltage	24 Vdc ±1%	24 Vdc ±1%
Output adjustable range	16 ... 28 Vdc	16 ... 28 Vdc
Continuous current	3 A at 50°C	5 A
Overload limiting	> 6 A per > 30 s	>6.2 A for >30 s
Short circuit peak current	15 A for 50 ms	15 A for 50 ms
Ripple @ nominal ratings	40 mVpp	50 mVpp
Hold up time	20 ms (120 Vac) / 70 ms (230 Vac)	20 ms (120 Vac) / 20 ms (230 Vac)
Status indication	LED "DC OK"	LED "DC OK"
Alarm contact	dry contact, max. 1A @ 24 Vdc (Uout >22.0 Vdc)	dry contact, max. 1A @ 24 Vdc (Uout >22.0 Vdc)
Parallel connection	possible	possible
Redundant parallel connection	possible with external ORing diode	possible with external ORing diode
GENERAL TECHNICAL DATA		
Efficiency	87% (120 Vac) / 87% (230 Vac)	85% (120 Vac) / 85% (230 Vac)
Dissipated power	10.8 W (120 Vac) / 10.8 W (230 Vac)	21.2 W (120 Vac) / 21.2 W (230 Vac)
Operating temperature range	-20...+70°C (derating -3 W/°C >50°C)	-20...+70°C (derating -3 W/°C >50°C)
Input / output isolation	3 kVac / 60 s (SELV output)	3 kVac / 60 s (SELV output)
Input / ground isolation	1.5 kVac / 60 s	1.5 kVac / 60 s
Output / ground isolation	0.5 kVac / 60 s	0.5 kVac / 60 s
Standard / approvals	EN 60950-1	EN 60950-1, EN 62368-1
EMC Standards	EN 61000-6-1, EN 61000-6-2, EN 61000-6-3, EN 61000-6-4	EN 61000-6-2, EN 61000-6-4
Overvoltage category / Pollution degree	II / 2	II / 2
Protection degree	IP 20	IP 20
Connection terminal IN/OUT	2.5 mm ² / 2.5 mm ²	2.5 mm ² / 2.5 mm ²
Housing material	aluminium	aluminium
Dimension	40x115x115 mm	40x115x115 mm
Approximate weight	400 g	400 g
Mounting information	vertical on a rail, 20 mm from adjacent components	vertical on a rail, 20 mm from adjacent components
APPROVALS	UL PENDING	UL PENDING
ACCESSORIES		
Mounting rail (IEC60715/TH35-7.5)	PR/3/AC, PR/3/AC/ZB, PR/3/AS, PR/3/AS/ZB	PR/3/AC, PR/3/AC/ZB, PR/3/AS, PR/3/AS/ZB
Mounting rail (IEC60715/TH35-15)	–	–
Marking tag	–	–





- Single phase input
- Short circuit, overload, input and output overvoltage protections
- Over temperature protection
- Suitable for standard applications

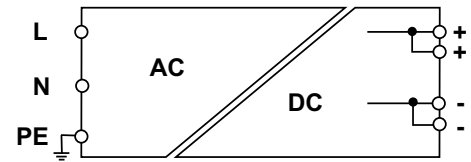
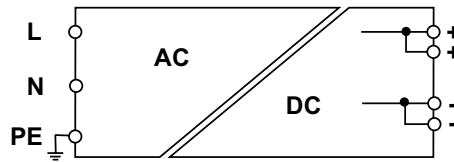

NOTE

Please refer to the datasheet for more details
Above overcurrent limit, the protection starts cycling in ON/OFF mode(hiccup autoreset), the maximum current supplied depends by the line resistance







CODE	XCSL85C	XCSL120C
TYPE	CSL85C	CSL120C
INPUT TECHNICAL DATA		
Input rated voltage	120–230 Vac	120–230 Vac
Input voltage AC	90...264 Vac	90...264 Vac
Input voltage DC	—	—
Frequency	47...63 Hz	47...63 Hz
Current consumption	1.6A (120 Vac) / 0.9 A (230 Vac)	1.9 A (120 Vac) / 1.1 A (230 Vac)
Inrush peak current	20 A	20 A
Power factor	> 0.65	> 0.65
Internal protection fuse	T 2 A	T 3.15 A
External protection on AC line	MCB: C-4 A / Fuse: T-4 A	MCB: C-4 A / Fuse: T-4 A
OUTPUT TECHNICAL DATA		
Output rated voltage	24 Vdc ±1%	24 Vdc ±1%
Output adjustable range	23...27.5 Vdc	23...27.5 Vdc
Continuous current	3.5 A at 45°C	5 A
Overload limiting	>5.5 A per >30 s	8 A for > 30 s
Short circuit peak current	9 A for 50 ms	13 A for 50 ms
Ripple @ nominal ratings	40 mVpp	30 mVpp
Hold up time	20 ms (120 Vac) / 70 ms (230 Vac)	17 ms (120 Vac) / 72 ms (230 Vac)
Status indication	LED "DC OK"	LED "DC OK"
Alarm contact	—	—
Parallel connection	possible	possible
Redundant parallel connection	possible with external ORing diode	possible with external ORing diode
GENERAL TECHNICAL DATA		
Efficiency	86% (120 Vac) / 90% (230 Vac)	86% (120 Vac) / 90% (230 Vac)
Dissipated power	14 W (120 Vac) / 10 W (230 Vac)	19 W (120 Vac) / 13 W (230 Vac)
Operating temperature range	-20...+60°C (derating -1.45 W >45°C)	-20...+60°C (derating -1.9 W >45°C)
Input / output isolation	3 kVac / 60 s (SELV output)	3 kVac / 60 s (SELV output)
Input / ground isolation	1.5 kVac / 60 s	1.5 kVac / 60 s
Output / ground isolation	0.5 kVac / 60 s	0.5 kVac / 60 s
Standard / approvals	EN 60950-1	EN 60950-1
EMC Standards	EN 61000-6-1, EN 61000-6-2, EN 61000-6-3, EN 61000-6-4	EN 61000-6-2, EN 61000-6-4
Overvoltage category / Pollution degree	II / 2	II / 2
Protection degree	IP 20	IP 20
Connection terminal IN/OUT	2.5 mm ² / 2.5 mm ²	2.5 mm ² / 2.5 mm ²
Housing material	aluminium	aluminium
Dimension	40x130x115 mm	40x130x115 mm
Approximate weight	400 g	400 g
Mounting information	vertical on a rail, 10 mm from adjacent components	vertical on a rail, 10 mm from adjacent components
APPROVALS	 	 
ACCESSORIES		
Mounting rail (IEC60715/TH35-7.5)	PR/3/AC, PR/3/AC/ZB, PR/3/AS, PR/3/AS/ZB	PR/3/AC, PR/3/AC/ZB, PR/3/AS, PR/3/AS/ZB
Mounting rail (IEC60715/TH35-15)	PR/3/PP, PR/3/PP/ZB, PR/3/PA, PR/3/PA/ZB	PR/3/PP, PR/3/PP/ZB, PR/3/PA, PR/3/PA/ZB
Marking tag	—	—

- Single phase input
- Short circuit, overload, input and output overvoltage protections
- Over temperature protection
- Suitable for standard applications

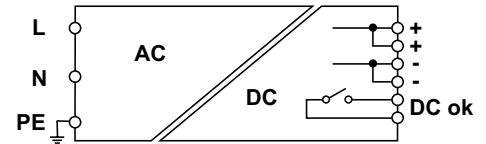
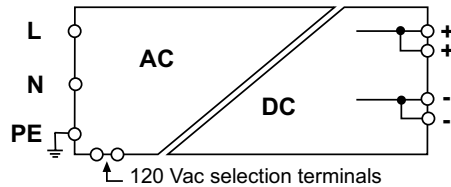
NOTE

Please refer to the datasheet for more details
Above overcurrent limit, the protection starts cycling in ON/OFF mode(hiccup autoreset), the maximum current supplied depends by the line resistance
(1) Dual voltage with selection through external jumper



CODE	XCSL240C	XCSL481C
TYPE	CSL240C	CSL481C
INPUT TECHNICAL DATA		
Input rated voltage	120–230 Vac	230 Vac
Input voltage AC	90...132 Vac / 185...264 Vac (1)	187...264 Vac
Input voltage DC	–	–
Frequency	47...63 Hz	47...63 Hz
Current consumption	3.5A (120 Vac) / 1.8 A (230 Vac)	2 A (230 Vac)
Inrush peak current	35 A	20 A
Power factor	> 0.6 / >0.85	> 0.95
Internal protection fuse	T 6.3 A	–
External protection on AC line	MCB: C-10 A / Fuse: T-10 A	MCB: C-6 A / Fuse: T-6.3 A
OUTPUT TECHNICAL DATA		
Output rated voltage	24 Vdc ±1%	24 Vdc ±1%
Output adjustable range	23...27.5 Vdc	23...27.5 Vdc
Continuous current	10 A at 45°C	20 A at 45°C
Overload limiting	15 A for >30 s	28 A
Short circuit peak current	25 A for 400 ms	50 A for 0.3 s
Ripple @ nominal ratings	50 mVpp	100 mVpp
Hold up time	30 ms (120 Vac) / 60 ms (230 Vac)	20 ms (230 Vac)
Status indication	LED "DC OK"	LED "DC OK"
Alarm contact	–	dry contact, max. 1A @ 24 Vdc (Uout >21.6 Vdc)
Parallel connection	possible	possible
Redundant parallel connection	possible with external ORing diode	possible with external ORing diode
GENERAL TECHNICAL DATA		
Efficiency	88% (120 Vac) / 90% (230 Vac)	92% (230 Vac)
Dissipated power	32 W (120 Vac) / 27 W (230 Vac)	42 W (230 Vac)
Operating temperature range	–20...+60°C (derating –4 W >45°C)	–20...+60°C (derating –16 W >45°C)
Input / output isolation	3 kVac / 60 s (SELV output)	3 kVac / 60 s (SELV output)
Input / ground isolation	1.5 kVac / 60 s	1.5 kVac / 60 s
Output / ground isolation	0.5 kVac / 60 s	0.5 kVac / 60 s
Standard / approvals	EN 60950-1	EN 60950-1
EMC Standards	EN 61000-6-1, EN 61000-6-2, EN 61000-6-3, EN 61000-6-4	EN 61000-6-2, EN 61000-6-4
Overvoltage category / Pollution degree	II / 2	II / 2
Protection degree	IP 20	IP 20
Connection terminal IN/OUT	2.5 mm ² / 2.5 mm ²	2.5 mm ² / 2.5 mm ²
Housing material	aluminium	aluminium
Dimension	63.5x135x140 mm	73x137x140 mm
Approximate weight	920 g	1 kg
Mounting information	vertical on a rail, 10 mm from adjacent components	vertical on a rail, 10 mm from adjacent components
APPROVALS	 	 
ACCESSORIES		
Mounting rail (IEC60715/TH35-7.5)	PR/3/AC, PR/3/AC/ZB, PR/3/AS, PR/3/AS/ZB	PR/3/AC, PR/3/AC/ZB, PR/3/AS, PR/3/AS/ZB
Mounting rail (IEC60715/TH35-15)	PR/3/PP, PR/3/PP/ZB, PR/3/PA, PR/3/PA/ZB	PR/3/PP, PR/3/PP/ZB, PR/3/PA, PR/3/PA/ZB
Marking tag	–	–

- Single phase and DC input
- Short circuit, overload, input and output overvoltage protections
- Over temperature protection
- Alarm contact
- High overload capability to ensure the protections selectivity and start-up of heavy loads



NOTE

(1) Standard version (product after September 2019)
 (2) With protective coating that allow installation in environment with extreme conditions (product on demand)
 Please refer to the datasheet for more details

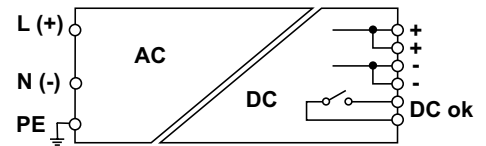
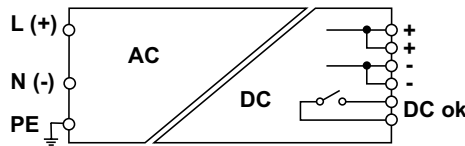

CODE	XCSL1480W024VAA	XCSL1480W024VGA
TYPE	CSL1-480W/024V/AA (1)	CSL1-480W/024V/GA (2)
INPUT TECHNICAL DATA		
Input rated voltage	120-230 Vac	120-230 Vac
Input voltage AC	85...264 Vac	85...264 Vac
Input voltage DC	100...370 Vdc (derating Uin<130 Vdc)	100...370 Vdc (derating Uin<130 Vdc)
Frequency	47...63 Hz	47...63 Hz
Current consumption	4.9 A (120 Vac) / 2.4 A (230 Vac)	4.9 A (120 Vac) / 2.4 A (230 Vac)
Inrush peak current	36 A	36 A
Power factor	> 0.99	> 0.99
Internal protection fuse	Yes 8 A	Yes 8 A
External protection on AC line	MCB: C-6 A / Fuse: T-6.3 A	MCB: C-6 A / Fuse: T-6.3 A
OUTPUT TECHNICAL DATA		
Output rated voltage	24 Vdc ±1%	24 Vdc ±1%
Output adjustable range	20 ... 28 Vdc	20 ... 28 Vdc
Continuous current	20 A at 50°C	20 A at 50°C
Overload limiting	22.5 A (max. 25 A constant current)	22.5 A (max. 25 A constant current)
Short circuit peak current	35A 300 ms On / 800 ms Off (HICcup mode)	35A 300 ms On / 800 ms Off (HICcup mode)
Ripple @ nominal ratings	200 mVpp	200 mVpp
Hold up time	18 ms (120 Vac) / 18 ms (230 Vac)	18 ms (120 Vac) / 18 ms (230 Vac)
Status indication	LED "DC OK", LED "Stand-by"	LED "DC OK", LED "Stand-by"
Alarm contact	dry contact, max. 1A @ 24 Vdc (Uout > 21.6 Vdc)	dry contact, max. 1A @ 24 Vdc (Uout > 21.6 Vdc)
Parallel connection	possible	possible
Redundant parallel connection	possible with external ORing diode	possible with external ORing diode
GENERAL TECHNICAL DATA		
Efficiency	90.7 %	90.7 %
Dissipated power	53 W	53 W
Operating temperature range	-20...+70°C (derating -14 W/°C >50°C)	-20...+70°C (derating -14 W/°C >50°C)
Input / output isolation	3 kVac / 60 s (SELV output)	3 kVac / 60 s (SELV output)
Input / ground isolation	1.5 kVac / 60 s	1.5 kVac / 60 s
Output / ground isolation	0.5 kVac / 60 s	0.5 kVac / 60 s
Standard / approvals	EN 60950-1	EN 60950-1
EMC Standards	EN 61000-6-1, EN 61000-6-2, EN 61000-6-3, EN 61000-6-4	EN 61000-6-1, EN 61000-6-2, EN 61000-6-3, EN 61000-6-4
Overvoltage category / Pollution degree	II / 2	II / 2
Protection degree	IP 20	IP 20
Connection terminal IN/OUT	4 mm ² / 4 mm ²	4 mm ² / 4 mm ²
Housing material	aluminium	aluminium
Dimension	80x170x127 mm	80x170x127 mm
Approximate weight	1.5 kg	1.5 kg
Mounting information	vertical on a rail, 20 mm from adjacent components	vertical on a rail, 20 mm from adjacent components
APPROVALS	CE UL PENDING	CE UL PENDING
ACCESSORIES		
Mounting rail (IEC60715/TH35-7.5)	PR/3/AC, PR/3/AC/ZB, PR/3/AS, PR/3/AS/ZB	PR/3/AC, PR/3/AC/ZB, PR/3/AS, PR/3/AS/ZB
Mounting rail (IEC60715/TH35-15)	—	—
Marking tag	—	—

- Single phase and DC input
- Short circuit, overload, input and output overvoltage protections
- Over temperature protection
- Alarm contact
- High overload capability to ensure the protections selectivity and start-up of heavy loads



NOTE

[3] With communication port that allow the connection to the net through the external interface XCCI001MB (product on demand)

Please refer to the datasheet for more details

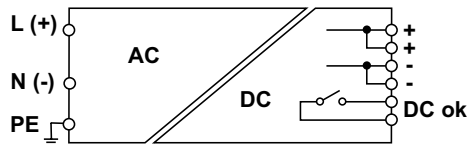

COMMUNICATION

XCCI001MB is a microprocessor-controlled communication interface that allow the connection to the net and the remote monitoring of the CSL1-480...AB/CSL3-480...AB power supply, by using the ModBus RTU protocol.

The communication Interface can be directly powered by the monitored PSU by the AUX2 port or can be powered by an auxiliary PSU (10 - 30 Vdc). This option allows the remote control of the PSU ON/OFF.

The connection to the ModBus net take place by 2 equivalent RJ-45 port.

CODE	XCSL1480W024VAB
TYPE	CSL1-480W/024V/AB (3)
INPUT TECHNICAL DATA	
Input rated voltage	120-230 Vac
Input voltage AC	85...264 Vac
Input voltage DC	100...370 Vdc [derating Uin<130 Vdc]
Frequency	47...63 Hz
Current consumption	4.9 A (120 Vac) / 2.4 A (230 Vac)
Inrush peak current	36 A
Power factor	> 0.99
Internal protection fuse	Yes 8 A
External protection on AC line	MCB: C-6 A / Fuse: T-6.3 A
OUTPUT TECHNICAL DATA	
Output rated voltage	24 Vdc ±1%
Output adjustable range	20 ... 28 Vdc
Continuous current	20 A at 50°C
Overload limiting	22.5 A (max. 25 A constant current)
Short circuit peak current	35A 300 ms On /800 ms Off (HICCUP mode)
Ripple @ nominal ratings	200 mVpp
Hold up time	18 ms (120 Vac) / 18 ms (230 Vac)
Status indication	LED "DC OK", LED "Stand-by"
Alarm contact	dry contact, max. 1A @ 24 Vdc (Uout >21.6 Vdc)
Parallel connection	possible
Redundant parallel connection	possible with external ORing diode
GENERAL TECHNICAL DATA	
Efficiency	90.7 %
Dissipated power	53 W
Operating temperature range	-20...+70°C (derating -14 W/°C >50°C)
Input / output isolation	3 kVac / 60 s (SELV output)
Input / ground isolation	1.5 kVac / 60 s
Output / ground isolation	0.5 kVac / 60 s
Standard / approvals	EN 60950-1
EMC Standards	EN 61000-6-1, EN 61000-6-2, EN 61000-6-3, EN 61000-6-4
Overvoltage category / Pollution degree	II / 2
Protection degree	IP 20
Connection terminal IN/OUT	4 mm ² / 4 mm ²
Housing material	aluminium
Dimension	80x170x127 mm
Approximate weight	1.5 kg
Mounting information	vertical on a rail, 20 mm from adjacent components
APPROVALS	UL PENDING
ACCESSORIES	
Mounting rail (IEC60715/TH35-7.5)	PR/3/AC, PR/3/AC/ZB, PR/3/AS, PR/3/AS/ZB
Mounting rail (IEC60715/TH35-15)	—
Marking tag	—

- Single phase and DC input
- Short circuit, overload, input and output overvoltage protections
- Over temperature protection
- Alarm contact
- High overload capability to ensure the protections selectivity and start-up of heavy loads
- —



NOTE

(1) Standard version (product after September 2019)
 (2) With protective coating that allow installation in environment with extreme conditions (product on demand)
 Please refer to the datasheet for more details

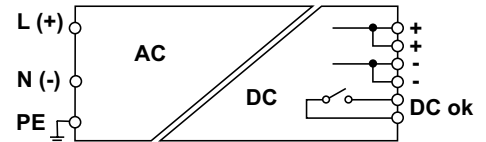
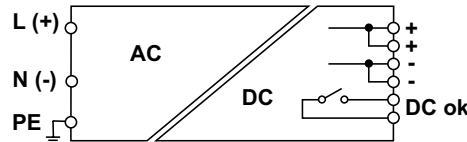

CODE	XCSL1480W048VAA	XCSL1480W048VGA
TYPE	CSL1-480W/048V/AA (1)	CSL1-480W/048V/GA (2)
INPUT TECHNICAL DATA		
Input rated voltage	120-230 Vac	120-230 Vac
Input voltage AC	85...264 Vac	85...264 Vac
Input voltage DC	100...370 Vdc (derating Uin<130 Vdc)	100...370 Vdc (derating Uin<130 Vdc)
Frequency	47...63 Hz	47...63 Hz
Current consumption	4.9 A (120 Vac) / 2.4 A (230 Vac)	4.9 A (120 Vac) / 2.4 A (230 Vac)
Inrush peak current	36 A	36 A
Power factor	> 0.99	> 0.99
Internal protection fuse	Yes 8 A	Yes 8 A
External protection on AC line	MCB: C-6 A / Fuse: T-6.3 A	MCB: C-6 A / Fuse: T-6.3 A
OUTPUT TECHNICAL DATA		
Output rated voltage	48 Vdc ±1%	48 Vdc ±1%
Output adjustable range	40.5 ... 55.5 Vdc	40.5 ... 55.5 Vdc
Continuous current	10 A at 50°C	10 A at 50°C
Overload limiting	11 A (max. 15 A constant current)	11 A (max. 15 A constant current)
Short circuit peak current	25A 100 ms On /800 ms Off (HICCUP mode)	25A 100 ms On /800 ms Off (HICCUP mode)
Ripple @ nominal ratings	200 mVpp	200 mVpp
Hold up time	18 ms (120 Vac) / 18 ms (230 Vac)	18 ms (120 Vac) / 18 ms (230 Vac)
Status indication	LED "DC OK", LED "Stand-by"	LED "DC OK", LED "Stand-by"
Alarm contact	dry contact, max. 1A @ 24 Vdc (Uout >43.2 Vdc)	dry contact, max. 1A @ 24 Vdc (Uout >43.2 Vdc)
Parallel connection	possible	possible
Redundant parallel connection	possible with external ORing diode	possible with external ORing diode
GENERAL TECHNICAL DATA		
Efficiency	90.9 %	90.9 %
Dissipated power	48 W	48 W
Operating temperature range	-20...+70°C (derating -14 W/°C >50°C)	-20...+70°C (derating -14 W/°C >50°C)
Input / output isolation	3 kVac / 60 s (SELV output)	3 kVac / 60 s (SELV output)
Input / ground isolation	1.5 kVac / 60 s	1.5 kVac / 60 s
Output / ground isolation	0.5 kVac / 60 s	0.5 kVac / 60 s
Standard / approvals	EN 60950-1	EN 60950-1
EMC Standards	EN 61000-6-1, EN 61000-6-2, EN 61000-6-3, EN 61000-6-4	EN 61000-6-1, EN 61000-6-2, EN 61000-6-3, EN 61000-6-4
Overvoltage category / Pollution degree	II / 2	II / 2
Protection degree	IP 20	IP 20
Connection terminal IN/OUT	4 mm ² / 4 mm ²	4 mm ² / 4 mm ²
Housing material	aluminium	aluminium
Dimension	80x170x127 mm	80x170x127 mm
Approximate weight	1.5 kg	1.5 kg
Mounting information	vertical on a rail, 20 mm from adjacent components	vertical on a rail, 20 mm from adjacent components
APPROVALS	UL PENDING	UL PENDING
ACCESSORIES		
Mounting rail (IEC60715/TH35-7.5)	PR/3/AC, PR/3/AC/ZB, PR/3/AS, PR/3/AS/ZB	PR/3/AC, PR/3/AC/ZB, PR/3/AS, PR/3/AS/ZB
Mounting rail (IEC60715/TH35-15)	—	—
Marking tag	—	—

- Single phase and DC input
- Short circuit, overload, input and output overvoltage protections
- Over temperature protection
- Alarm contact
- High overload capability to ensure the protections selectivity and start-up of heavy loads
- —



NOTE

[3] With communication port that allow the connection to the net through the external interface XCCI001MB (product on demand)

Please refer to the datasheet for more details

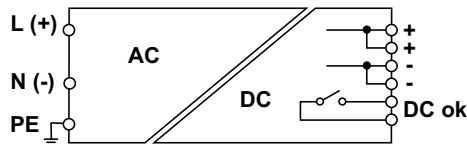

CODE	XCSL1480W048VAB
TYPE	CSL1-480W/048V/AB (3)
INPUT TECHNICAL DATA	
Input rated voltage	120-230 Vac
Input voltage AC	85...264 Vac
Input voltage DC	100...370 Vdc [derating Uin<130 Vdc]
Frequency	47...63 Hz
Current consumption	4.9 A (120 Vac) / 2.4 A (230 Vac)
Inrush peak current	36 A
Power factor	> 0.99
Internal protection fuse	Yes 8 A
External protection on AC line	MCB: C-6 A / Fuse: T-6.3 A
OUTPUT TECHNICAL DATA	
Output rated voltage	48 Vdc ±1%
Output adjustable range	40.5 ... 55.5 Vdc
Continuous current	10 A at 50°C
Overload limiting	11 A (max. 15 A constant current)
Short circuit peak current	25A 100 ms On /800 ms Off (HICCUP mode)
Ripple @ nominal ratings	200 mVpp
Hold up time	18 ms (120 Vac) / 18 ms (230 Vac)
Status indication	LED "DC OK", LED "Stand-by"
Alarm contact	dry contact, max. 1A @ 24 Vdc (Uout >43.2 Vdc)
Parallel connection	possible
Redundant parallel connection	possible with external ORing diode
GENERAL TECHNICAL DATA	
Efficiency	90.9 %
Dissipated power	48 W
Operating temperature range	-20...+70°C (derating -14 W/°C >50°C)
Input / output isolation	3 kVac / 60 s (SELV output)
Input / ground isolation	1.5 kVac / 60 s
Output / ground isolation	0.5 kVac / 60 s
Standard / approvals	EN 60950-1
EMC Standards	EN 61000-6-1, EN 61000-6-2, EN 61000-6-3, EN 61000-6-4
Overvoltage category / Pollution degree	II / 2
Protection degree	IP 20
Connection terminal IN/OUT	4 mm ² / 4 mm ²
Housing material	aluminium
Dimension	80x170x127 mm
Approximate weight	1.5 kg
Mounting information	vertical on a rail, 20 mm from adjacent components
APPROVALS	CE UL PENDING
ACCESSORIES	
Mounting rail (IEC60715/TH35-7.5)	PR/3/AC, PR/3/AC/ZB, PR/3/AS, PR/3/AS/ZB
Mounting rail (IEC60715/TH35-15)	—
Marking tag	—

COMUNICAZIONE

XCI001MB è un'interfaccia di comunicazione controllata da un microprocessore che permette il monitoraggio e la connessione alla rete e degli alimentatori serie CSL1-480...AB / CSL3-480...AB tramite protocollo ModBus RTU.

L'interfaccia ha la possibilità di essere alimentata direttamente dall'alimentatore monitorato tramite la porta AUX2 oppure può essere alimentata da una fonte ausiliaria 10...30 Vdc, questa seconda opzione permette di gestire l'accensione e lo spegnimento remoto dell'alimentatore.

La comunicazione tramite protocollo ModBus RTU avviene tramite porte RJ-45.

Per ulteriori dettagli far riferimento alla pagina di prodotto.

- Single phase and DC input
- Short circuit, overload, input and output overvoltage protections
- Over temperature protection
- Alarm contact
- High overload capability to ensure the protections selectivity and start-up of heavy loads
- —



NOTE

(1) Standard version (product after September 2019)
 (2) With protective coating that allow installation in environment with extreme conditions (product on demand)
 Please refer to the datasheet for more details

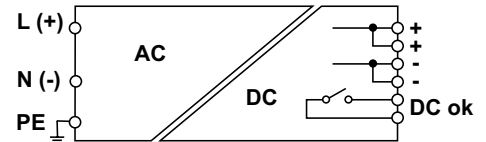
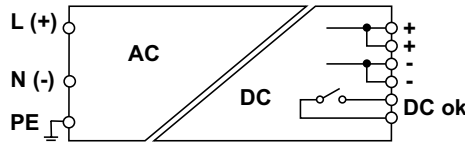

CODE	XCSL1480W072VAA	XCSL1480W072VGA
TYPE	CSL1-480W/072V/AA (1)	CSL1-480W/072V/GA (2)
INPUT TECHNICAL DATA		
Input rated voltage	120-230 Vac	120-230 Vac
Input voltage AC	85...264 Vac	85...264 Vac
Input voltage DC	100...370 Vdc (derating Uin<130 Vdc)	100...370 Vdc (derating Uin<130 Vdc)
Frequency	47...63 Hz	47...63 Hz
Current consumption	4.9 A (120 Vac) / 2.4 A (230 Vac)	4.9 A (120 Vac) / 2.4 A (230 Vac)
Inrush peak current	36 A	36 A
Power factor	> 0.99	> 0.99
Internal protection fuse	Yes 8 A	Yes 8 A
External protection on AC line	MCB: C-6 A / Fuse: T-6.3 A	MCB: C-6 A / Fuse: T-6.3 A
OUTPUT TECHNICAL DATA		
Output rated voltage	72 Vdc ±1%	72 Vdc ±1%
Output adjustable range	62.5 ... 81 Vdc	62.5 ... 81 Vdc
Continuous current	6.6 A at 50°C	6.6 A at 50°C
Overload limiting	7.5 A (max. 9 A constant current)	7.5 A (max. 9 A constant current)
Short circuit peak current	18A 100 ms On /800 ms Off (HICCUP mode)	18A 100 ms On /800 ms Off (HICCUP mode)
Ripple @ nominal ratings	200 mVpp	200 mVpp
Hold up time	18 ms (120 Vac) / 18 ms (230 Vac)	18 ms (120 Vac) / 18 ms (230 Vac)
Status indication	LED "DC OK", LED "Stand-by"	LED "DC OK", LED "Stand-by"
Alarm contact	dry contact, max. 1A @ 24 Vdc (Uout >68.4 Vdc)	dry contact, max. 1A @ 24 Vdc (Uout >68.4 Vdc)
Parallel connection	possible	possible
Redundant parallel connection	possible with external ORing diode	possible with external ORing diode
GENERAL TECHNICAL DATA		
Efficiency	91.5 %	91.5 %
Dissipated power	44 W	44 W
Operating temperature range	-20...+70°C (derating -14 W/°C >50°C)	-20...+70°C (derating -14 W/°C >50°C)
Input / output isolation	3 kVac / 60 s (no SELV output)	3 kVac / 60 s (no SELV output)
Input / ground isolation	1.5 kVac / 60 s	1.5 kVac / 60 s
Output / ground isolation	0.5 kVac / 60 s	0.5 kVac / 60 s
Standard / approvals	EN 60950-1	EN 60950-1
EMC Standards	EN 61000-6-1, EN 61000-6-2, EN 61000-6-3, EN 61000-6-4	EN 61000-6-1, EN 61000-6-2, EN 61000-6-3, EN 61000-6-4
Overvoltage category / Pollution degree	II / 2	II / 2
Protection degree	IP 20	IP 20
Connection terminal IN/OUT	4 mm ² / 4 mm ²	4 mm ² / 4 mm ²
Housing material	aluminium	aluminium
Dimension	80x170x127 mm	80x170x127 mm
Approximate weight	1.5 kg	1.5 kg
Mounting information	vertical on a rail, 20 mm from adjacent components	vertical on a rail, 20 mm from adjacent components
APPROVALS	UL PENDING	UL PENDING
ACCESSORIES		
Mounting rail (IEC60715/TH35-7.5)	PR/3/AC, PR/3/AC/ZB, PR/3/AS, PR/3/AS/ZB	PR/3/AC, PR/3/AC/ZB, PR/3/AS, PR/3/AS/ZB
Mounting rail (IEC60715/TH35-15)	—	—
Marking tag	—	—

- Single phase and DC input
- Short circuit, overload, input and output overvoltage protections
- Over temperature protection
- Alarm contact
- High overload capability to ensure the protections selectivity and start-up of heavy loads
- —



NOTE

[3] With communication port that allow the connection to the net through the external interface XCCI001MB (product on demand)

Please refer to the datasheet for more details

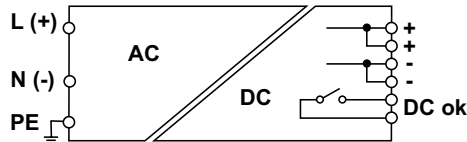

CODE	XCSL1480W072VAB
TYPE	CSL1-480W/072V/AB (3)
INPUT TECHNICAL DATA	
Input rated voltage	120-230 Vac
Input voltage AC	85...264 Vac
Input voltage DC	100...370 Vdc [derating Uin<130 Vdc]
Frequency	47...63 Hz
Current consumption	4.9 A (120 Vac) / 2.4 A (230 Vac)
Inrush peak current	36 A
Power factor	> 0.99
Internal protection fuse	Yes 8 A
External protection on AC line	MCB: C-6 A / Fuse: T-6.3 A
OUTPUT TECHNICAL DATA	
Output rated voltage	72 Vdc ±1%
Output adjustable range	62.5 ... 81 Vdc
Continuous current	6.6 A at 50°C
Overload limiting	7.5 A (max. 9 A constant current)
Short circuit peak current	18A 100 ms On /800 ms Off (HICCUP mode)
Ripple @ nominal ratings	200 mVpp
Hold up time	18 ms (120 Vac) / 18 ms (230 Vac)
Status indication	LED "DC OK", LED "Stand-by"
Alarm contact	dry contact, max. 1A @ 24 Vdc (Uout >68.4 Vdc)
Parallel connection	possible
Redundant parallel connection	possible with external ORing diode
GENERAL TECHNICAL DATA	
Efficiency	91.5 %
Dissipated power	44 W
Operating temperature range	-20...+70°C (derating -14 W/°C >50°C)
Input / output isolation	3 kVac / 60 s (no SELV output)
Input / ground isolation	1.5 kVac / 60 s
Output / ground isolation	0.5 kVac / 60 s
Standard / approvals	EN 60950-1
EMC Standards	EN 61000-6-1, EN 61000-6-2, EN 61000-6-3, EN 61000-6-4
Overvoltage category / Pollution degree	II / 2
Protection degree	IP 20
Connection terminal IN/OUT	4 mm ² / 4 mm ²
Housing material	aluminium
Dimension	80x170x127 mm
Approximate weight	1.5 kg
Mounting information	vertical on a rail, 20 mm from adjacent components
APPROVALS	UL PENDING
ACCESSORIES	
Mounting rail (IEC60715/TH35-7.5)	PR/3/AC, PR/3/AC/ZB, PR/3/AS, PR/3/AS/ZB
Mounting rail (IEC60715/TH35-15)	—
Marking tag	—

COMUNICAZIONE

XCI001MB è un'interfaccia di comunicazione controllata da un microprocessore che permette il monitoraggio e la connessione alla rete e degli alimentatori serie CSL1-480...AB / CSL3-480...AB tramite protocollo ModBus RTU.

L'interfaccia ha la possibilità di essere alimentata direttamente dall'alimentatore monitorato tramite la porta AUX2 oppure può essere alimentata da una fonte ausiliaria 10...30 Vdc, questa seconda opzione permette di gestire l'accensione e lo spegnimento remoto dell'alimentatore.

La comunicazione tramite protocollo ModBus RTU avviene tramite porte RJ-45.

Per ulteriori dettagli far riferimento alla pagina di prodotto.

- 3-phase 400-500 Vac input
- Short circuit, overload, input and output overvoltage protections
- Over temperature protection
- Alarm contact
- High overload capability to ensure the protections selectivity and start-up of heavy loads
- —



NOTE

- (1) Standard version
 (2) With protective coating that allow installation in environment with extreme conditions (product on demand)
 Please refer to the datasheet for more details

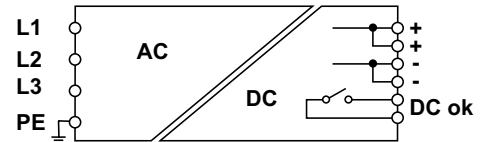
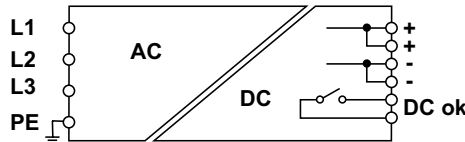

CODE	XCSL3480W024VAA	XCSL3480W024VGA
TYPE	CSL3-480W/024V/AA (1)	CSL3-480W/024V/GA (2)
INPUT TECHNICAL DATA		
Input rated voltage	3x 400-500 Vac	3x 400-500 Vac
Input voltage AC	340...550 Vac	340...550 Vac
Input voltage DC	500 - 600 Vdc	500 - 600 Vdc
Frequency	47...63 Hz	47...63 Hz
Current consumption	1.31 A (400 Vac)	1.31 A (400 Vac)
Inrush peak current	22 A	22 A
Power factor	0.76	0.76
Internal protection fuse	—	—
External protection on AC line	MCB: C-4 A / Fuse: T-3.15 A	MCB: C-4 A / Fuse: T-3.15 A
OUTPUT TECHNICAL DATA		
Output rated voltage	24 Vdc ±1%	24 Vdc ±1%
Output adjustable range	20 ... 28 Vdc	20 ... 28 Vdc
Continuous current	20 A at 50°C	20 A at 50°C
Overload limiting	23 A (max. 27 A constant current)	23A (max. 27 A constant current)
Short circuit peak current	35A 400 ms On /800 ms Off (HICCUP mode)	35A 400 ms On /800 ms Off (HICCUP mode)
Ripple @ nominal ratings	200 mVpp	200 mVpp
Hold up time	10 ms (400 Vac)	10 ms (400 Vac)
Status indication	LED "DC OK", LED "Stand-by"	LED "DC OK", LED "Stand-by"
Alarm contact	dry contact, max. 1A @ 24 Vdc (Uout >21.6 Vdc)	dry contact, max. 1A @ 24 Vdc (Uout >21.6 Vdc)
Parallel connection	possible	possible
Redundant parallel connection	possible with external ORing diode	possible with external ORing diode
GENERAL TECHNICAL DATA		
Efficiency	90.5% (400 Vac)	90.5% (400 Vac)
Dissipated power	48 W (400 Vac)	48 W (400 Vac)
Operating temperature range	-20...+70°C (derating -14 W/°C >50°C)	-20...+70°C (derating -14 W/°C >50°C)
Input / output isolation	3 kVac / 60 s (SELV output)	3 kVac / 60 s (SELV output)
Input / ground isolation	1.5 kVac / 60 s	1.5 kVac / 60 s
Output / ground isolation	0.5 kVac / 60 s	0.5 kVac / 60 s
Standard / approvals	EN 60950-1	EN 60950-1
EMC Standards	EN 61000-6-1, EN 61000-6-2, EN 61000-6-3, EN 61000-6-4	EN 61000-6-1, EN 61000-6-2, EN 61000-6-3, EN 61000-6-4
Overvoltage category / Pollution degree	II / 2	II / 2
Protection degree	IP 20	IP 20
Connection terminal IN/OUT	4 mm ² / 4 mm ²	4 mm ² / 4 mm ²
Housing material	aluminium	aluminium
Dimension	80x170x127 mm	80x170x127 mm
Approximate weight	1.5 kg	1.5 kg
Mounting information	vertical on a rail, 20 mm from adjacent components	vertical on a rail, 20 mm from adjacent components
APPROVALS	UL PENDING	UL PENDING
ACCESSORIES		
Mounting rail (IEC60715/TH35-7.5)	PR/3/AC, PR/3/AC/ZB, PR/3/AS, PR/3/AS/ZB	PR/3/AC, PR/3/AC/ZB, PR/3/AS, PR/3/AS/ZB
Mounting rail (IEC60715/TH35-15)	—	—
Marking tag	—	—

- 3-phase 400-500 Vac input
- Short circuit, overload, input and output overvoltage protections
- Over temperature protection
- Alarm contact
- High overload capability to ensure the protections selectivity and start-up of heavy loads
- —



NOTE

[3] With communication port that allow the connection to the net through the external interface XCCI001MB (product on demand)

Please refer to the datasheet for more details

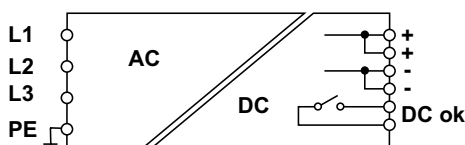

CODE	XCSL3480W024VAB
TYPE	CSL3-480W/024V/AB (3)
INPUT TECHNICAL DATA	
Input rated voltage	3x 400-500 Vac
Input voltage AC	340...550 Vac
Input voltage DC	500 - 600 Vdc
Frequency	47...63 Hz
Current consumption	1.31 A (400 Vac)
Inrush peak current	22 A
Power factor	0.76
Internal protection fuse	—
External protection on AC line	MCB: C-4 A / Fuse: T-3.15 A
OUTPUT TECHNICAL DATA	
Output rated voltage	24 Vdc ±1%
Output adjustable range	20 ... 28 Vdc
Continuous current	20 A at 50°C
Overload limiting	23 A (max. 27 A constant current)
Short circuit peak current	35A 400 ms On /800 ms Off (HICCUP mode)
Ripple @ nominal ratings	200 mVpp
Hold up time	10 ms (400 Vac)
Status indication	LED "DC OK", LED "Stand-by"
Alarm contact	dry contact, max. 1A @ 24 Vdc (Uout >21.6 Vdc)
Parallel connection	possible
Redundant parallel connection	possible with external ORing diode
GENERAL TECHNICAL DATA	
Efficiency	90.5% (400 Vac)
Dissipated power	48 W (400 Vac)
Operating temperature range	-20...+70°C (derating -14 W/°C >50°C)
Input / output isolation	3 kVac / 60 s (SELV output)
Input / ground isolation	1.5 kVac / 60 s
Output / ground isolation	0.5 kVac / 60 s
Standard / approvals	EN 60950-1
EMC Standards	EN 61000-6-1, EN 61000-6-2, EN 61000-6-3, EN 61000-6-4
Overvoltage category / Pollution degree	II / 2
Protection degree	IP 20
Connection terminal IN/OUT	4 mm ² / 4 mm ²
Housing material	aluminium
Dimension	80x170x127 mm
Approximate weight	1.5 kg
Mounting information	vertical on a rail, 20 mm from adjacent components
APPROVALS	UL PENDING
ACCESSORIES	
Mounting rail (IEC60715/TH35-7.5)	PR/3/AC, PR/3/AC/ZB, PR/3/AS, PR/3/AS/ZB
Mounting rail (IEC60715/TH35-15)	—
Marking tag	—

COMUNICAZIONE

XCCI001MB è un'interfaccia di comunicazione controllata da un microprocessore che permette il monitoraggio e la connessione alla rete e degli alimentatori serie CSL1-480...AB / CSL3-480...AB tramite protocollo ModBus RTU.

L'interfaccia ha la possibilità di essere alimentata direttamente dall'alimentatore monitorato tramite la porta AUX2 oppure può essere alimentata da una fonte ausiliaria 10...30 Vdc, questa seconda opzione permette di gestire l'accensione e lo spegnimento remoto dell'alimentatore.

La comunicazione tramite protocollo ModBus RTU avviene tramite porte RJ-45.

Per ulteriori dettagli far riferimento alla pagina di prodotto.

- 3-phase 400-500 Vac input
- Short circuit, overload, input and output overvoltage protections
- Over temperature protection
- Alarm contact
- High overload capability to ensure the protections selectivity and start-up of heavy loads
- —



NOTE

(1) Standard version (product after September 2019)
 (2) With protective coating that allow installation in environment with extreme conditions (product on demand)
 Please refer to the datasheet for more details

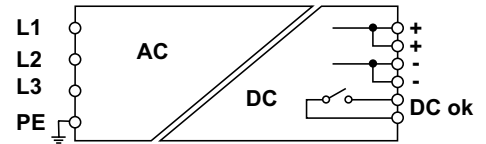
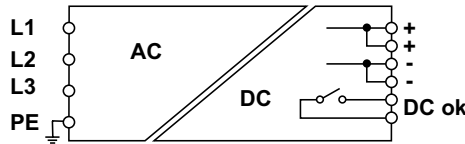

CODE	XCSL3480W048VAA	XCSL3480W048VGA
TYPE	CSL3-480W/048V/AA (1)	CSL3-480W/048V/GA (2)
INPUT TECHNICAL DATA		
Input rated voltage	3x 400-500 Vac	3x 400-500 Vac
Input voltage AC	340...550 Vac	340...550 Vac
Input voltage DC	500 - 600 Vdc	500 - 600 Vdc
Frequency	47...63 Hz	47...63 Hz
Current consumption	1.31 A (400 Vac)	1.31 A (400 Vac)
Inrush peak current	22 A	22 A
Power factor	0.76	0.76
Internal protection fuse	—	—
External protection on AC line	MCB: C-4 A / Fuse: T-3.15 A	MCB: C-4 A / Fuse: T-3.15 A
OUTPUT TECHNICAL DATA		
Output rated voltage	48 Vdc ±1%	48 Vdc ±1%
Output adjustable range	40.5 ... 55.5 Vdc	40.5 ... 55.5 Vdc
Continuous current	10 A at 50°C	10 A at 50°C
Overload limiting	14 A (max. 20 A constant current)	14 A (max. 20 A constant current)
Short circuit peak current	30A 400 ms On /800 ms Off (HICCUP mode)	30A 400 ms On /800 ms Off (HICCUP mode)
Ripple @ nominal ratings	200 mVpp	200 mVpp
Hold up time	10 ms (400 Vac)	10 ms (400 Vac)
Status indication	LED "DC OK", LED "Stand-by"	LED "DC OK", LED "Stand-by"
Alarm contact	dry contact, max. 1A @ 24 Vdc (Uout >43.2 Vdc)	dry contact, max. 1A @ 24 Vdc (Uout >43.2 Vdc)
Parallel connection	possible	possible
Redundant parallel connection	possible with external ORing diode	possible with external ORing diode
GENERAL TECHNICAL DATA		
Efficiency	91% (400 Vac)	91% (400 Vac)
Dissipated power	47.5 W (400 Vac)	47.5 W (400 Vac)
Operating temperature range	-20...+70°C (derating -14 W/°C >50°C)	-20...+70°C (derating -14 W/°C >50°C)
Input / output isolation	3 kVac / 60 s (SELV output)	3 kVac / 60 s (SELV output)
Input / ground isolation	1.5 kVac / 60 s	1.5 kVac / 60 s
Output / ground isolation	0.5 kVac / 60 s	0.5 kVac / 60 s
Standard / approvals	EN 60950-1	EN 60950-1
EMC Standards	EN 61000-6-1, EN 61000-6-2, EN 61000-6-3, EN 61000-6-4	EN 61000-6-1, EN 61000-6-2, EN 61000-6-3, EN 61000-6-4
Overvoltage category / Pollution degree	II / 2	II / 2
Protection degree	IP 20	IP 20
Connection terminal IN/OUT	4 mm ² / 4 mm ²	4 mm ² / 4 mm ²
Housing material	aluminium	aluminium
Dimension	80x170x127 mm	80x170x127 mm
Approximate weight	1.5 kg	1.5 kg
Mounting information	vertical on a rail, 20 mm from adjacent components	vertical on a rail, 20 mm from adjacent components
APPROVALS	UL PENDING	UL PENDING
ACCESSORIES		
Mounting rail (IEC60715/TH35-7.5)	PR/3/AC, PR/3/AC/ZB, PR/3/AS, PR/3/AS/ZB	PR/3/AC, PR/3/AC/ZB, PR/3/AS, PR/3/AS/ZB
Mounting rail (IEC60715/TH35-15)	—	—
Marking tag	—	—

- 3-phase 400-500 Vac input
- Short circuit, overload, input and output overvoltage protections
- Over temperature protection
- Alarm contact
- High overload capability to ensure the protections selectivity and start-up of heavy loads
- —



NOTE

[3] With communication port that allow the connection to the net through the external interface XCCI001MB (product on demand)

Please refer to the datasheet for more details

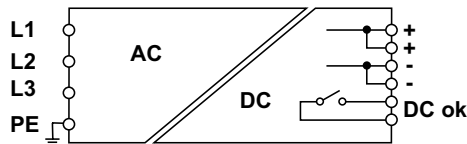

CODE	XCSL3480W048VAB
TYPE	CSL3-480W/048V/AB (3)
INPUT TECHNICAL DATA	
Input rated voltage	3x 400-500 Vac
Input voltage AC	340...550 Vac
Input voltage DC	500 - 600 Vdc
Frequency	47...63 Hz
Current consumption	1.31 A (400 Vac)
Inrush peak current	22 A
Power factor	0.76
Internal protection fuse	—
External protection on AC line	MCB: C-4 A / Fuse: T-3.15 A
OUTPUT TECHNICAL DATA	
Output rated voltage	48 Vdc ±1%
Output adjustable range	40.5 ... 55.5 Vdc
Continuous current	10 A at 50°C
Overload limiting	14 A (max. 20 A constant current)
Short circuit peak current	30A 400 ms On /800 ms Off (HICCUP mode)
Ripple @ nominal ratings	200 mVpp
Hold up time	10 ms (400 Vac)
Status indication	LED "DC OK", LED "Stand-by"
Alarm contact	dry contact, max. 1A @ 24 Vdc (Uout >43.2 Vdc)
Parallel connection	possible
Redundant parallel connection	possible with external ORing diode
GENERAL TECHNICAL DATA	
Efficiency	91% (400 Vac)
Dissipated power	47.5 W (400 Vac)
Operating temperature range	-20...+70°C (derating -14 W/°C >50°C)
Input / output isolation	3 kVac / 60 s (SELV output)
Input / ground isolation	1.5 kVac / 60 s
Output / ground isolation	0.5 kVac / 60 s
Standard / approvals	EN 60950-1
EMC Standards	EN 61000-6-1, EN 61000-6-2, EN 61000-6-3, EN 61000-6-4
Overvoltage category / Pollution degree	II / 2
Protection degree	IP 20
Connection terminal IN/OUT	4 mm ² / 4 mm ²
Housing material	aluminium
Dimension	80x170x127 mm
Approximate weight	1.5 kg
Mounting information	vertical on a rail, 20 mm from adjacent components
APPROVALS	UL PENDING
ACCESSORIES	
Mounting rail (IEC60715/TH35-7.5)	PR/3/AC, PR/3/AC/ZB, PR/3/AS, PR/3/AS/ZB
Mounting rail (IEC60715/TH35-15)	—
Marking tag	—

COMUNICAZIONE

XCI001MB è un'interfaccia di comunicazione controllata da un microprocessore che permette il monitoraggio e la connessione alla rete e degli alimentatori serie CSL1-480...AB / CSL3-480...AB tramite protocollo ModBus RTU.

L'interfaccia ha la possibilità di essere alimentata direttamente dall'alimentatore monitorato tramite la porta AUX2 oppure può essere alimentata da una fonte ausiliaria 10...30 Vdc, questa seconda opzione permette di gestire l'accensione e lo spegnimento remoto dell'alimentatore.

La comunicazione tramite protocollo ModBus RTU avviene tramite porte RJ-45.

Per ulteriori dettagli far riferimento alla pagina di prodotto.

- 3-phase 400-500 Vac input
- Short circuit, overload, input and output overvoltage protections
- Over temperature protection
- Alarm contact
- High overload capability to ensure the protections selectivity and start-up of heavy loads
- —



NOTE

(1) Standard version (product after September 2019)
 (2) With protective coating that allow installation in environment with extreme conditions (product on demand)
 Please refer to the datasheet for more details

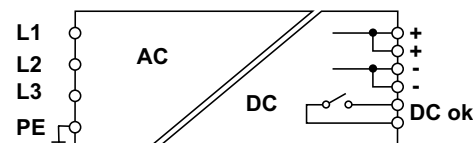
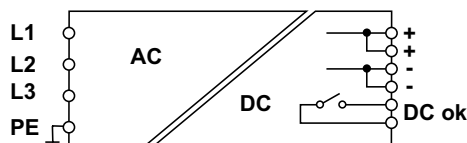

CODE	XCSL3480W072VAA	XCSL3480W072VGA
TYPE	CSL3-480W/072V/AA (1)	CSL3-480W/072V/GA (2)
INPUT TECHNICAL DATA		
Input rated voltage	3x 400-500 Vac	3x 400-500 Vac
Input voltage AC	340...550 Vac	340...550 Vac
Input voltage DC	500 - 600 Vdc	500 - 600 Vdc
Frequency	47...63 Hz	47...63 Hz
Current consumption	1.31 A (400 Vac)	1.31 A (400 Vac)
Inrush peak current	22 A	22 A
Power factor	0.76	0.76
Internal protection fuse	—	—
External protection on AC line	MCB: C-4 A / Fuse: T-3.15 A	MCB: C-4 A / Fuse: T-3.15 A
OUTPUT TECHNICAL DATA		
Output rated voltage	72 Vdc ±1%	72 Vdc ±1%
Output adjustable range	60 ... 81 Vdc	60 ... 81 Vdc
Continuous current	6.6 A at 50°C	6.6 A at 50°C
Overload limiting	9 A (max. 12 A constant current)	9 A (max. 12 A constant current)
Short circuit peak current	26A 400 ms On /800 ms Off (HICCUP mode)	26A 400 ms On /800 ms Off (HICCUP mode)
Ripple @ nominal ratings	200 mVpp	200 mVpp
Hold up time	10 ms (400 Vac)	10 ms (400 Vac)
Status indication	LED "DC OK", LED "Stand-by"	LED "DC OK", LED "Stand-by"
Alarm contact	dry contact, max. 1A @ 24 Vdc (Uout >68.4 Vdc)	dry contact, max. 1A @ 24 Vdc (Uout >68.4 Vdc)
Parallel connection	possible	possible
Redundant parallel connection	possible with external ORing diode	possible with external ORing diode
GENERAL TECHNICAL DATA		
Efficiency	91.5% (400 Vac)	91.5% (400 Vac)
Dissipated power	44.6 W (400 Vac)	44.6 W (400 Vac)
Operating temperature range	-20...+70°C (derating -14 W/°C >50°C)	-20...+70°C (derating -14 W/°C >50°C)
Input / output isolation	3 kVac / 60 s (no SELV output)	3 kVac / 60 s (no SELV output)
Input / ground isolation	1.5 kVac / 60 s	1.5 kVac / 60 s
Output / ground isolation	0.5 kVac / 60 s	0.5 kVac / 60 s
Standard / approvals	EN 60950-1	EN 60950-1
EMC Standards	EN 61000-6-1, EN 61000-6-2, EN 61000-6-3, EN 61000-6-4	EN 61000-6-1, EN 61000-6-2, EN 61000-6-3, EN 61000-6-4
Overvoltage category / Pollution degree	II / 2	II / 2
Protection degree	IP 20	IP 20
Connection terminal IN/OUT	4 mm ² / 4 mm ²	4 mm ² / 4 mm ²
Housing material	aluminium	aluminium
Dimension	80x170x127 mm	80x170x127 mm
Approximate weight	1.5 kg	1.5 kg
Mounting information	vertical on a rail, 20 mm from adjacent components	vertical on a rail, 20 mm from adjacent components
APPROVALS	UL PENDING	UL PENDING
ACCESSORIES		
Mounting rail (IEC60715/TH35-7.5)	PR/3/AC, PR/3/AC/ZB, PR/3/AS, PR/3/AS/ZB	PR/3/AC, PR/3/AC/ZB, PR/3/AS, PR/3/AS/ZB
Mounting rail (IEC60715/TH35-15)	—	—
Marking tag	—	—

- 3-phase 400-500 Vac input
- Short circuit, overload, input and output overvoltage protections
- Over temperature protection
- Alarm contact
- High overload capability to ensure the protections selectivity and start-up of heavy loads
- —



NOTE

[3] With communication port that allow the connection to the net through the external interface XCCI001MB (product on demand)

Please refer to the datasheet for more details

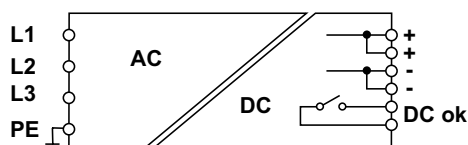

CODE	XCSL3480W072VAB
TYPE	CSL3-480W/072V/AB [3]
INPUT TECHNICAL DATA	
Input rated voltage	3x 400-500 Vac
Input voltage AC	340...550 Vac
Input voltage DC	500 - 600 Vdc
Frequency	47...63 Hz
Current consumption	1.31 A (400 Vac)
Inrush peak current	22 A
Power factor	0.76
Internal protection fuse	—
External protection on AC line	MCB: C-4 A / Fuse: T-3.15 A
OUTPUT TECHNICAL DATA	
Output rated voltage	72 Vdc ±1%
Output adjustable range	60 ... 81 Vdc
Continuous current	6.6 A at 50°C
Overload limiting	9 A (max. 12 A constant current)
Short circuit peak current	26A 400 ms On /800 ms Off (HICCUP mode)
Ripple @ nominal ratings	200 mVpp
Hold up time	10 ms (400 Vac)
Status indication	LED "DC OK", LED "Stand-by"
Alarm contact	dry contact, max. 1A @ 24 Vdc (Uout >68.4 Vdc)
Parallel connection	possible
Redundant parallel connection	possible with external ORing diode
GENERAL TECHNICAL DATA	
Efficiency	91.5% (400 Vac)
Dissipated power	44.6 W (400 Vac)
Operating temperature range	-20...+70°C (derating -14 W/°C >50°C)
Input / output isolation	3 kVac / 60 s (no SELV output)
Input / ground isolation	1.5 kVac / 60 s
Output / ground isolation	0.5 kVac / 60 s
Standard / approvals	EN 60950-1
EMC Standards	EN 61000-6-1, EN 61000-6-2, EN 61000-6-3, EN 61000-6-4
Overvoltage category / Pollution degree	II / 2
Protection degree	IP 20
Connection terminal IN/OUT	4 mm ² / 4 mm ²
Housing material	aluminium
Dimension	80x170x127 mm
Approximate weight	1.5 kg
Mounting information	vertical on a rail, 20 mm from adjacent components
APPROVALS	UL PENDING
ACCESSORIES	
Mounting rail (IEC60715/TH35-7.5)	PR/3/AC, PR/3/AC/ZB, PR/3/AS, PR/3/AS/ZB
Mounting rail (IEC60715/TH35-15)	—
Marking tag	—

COMUNICAZIONE

XCI001MB è un'interfaccia di comunicazione controllata da un microprocessore che permette il monitoraggio e la connessione alla rete e degli alimentatori serie CSL1-480...AB / CSL3-480...AB tramite protocollo ModBus RTU.

L'interfaccia ha la possibilità di essere alimentata direttamente dall'alimentatore monitorato tramite la porta AUX2 oppure può essere alimentata da una fonte ausiliaria 10...30 Vdc, questa seconda opzione permette di gestire l'accensione e lo spegnimento remoto dell'alimentatore.

La comunicazione tramite protocollo ModBus RTU avviene tramite porte RJ-45.

Per ulteriori dettagli far riferimento alla pagina di prodotto.

A series of 18 horizontal grey bars, each representing a line of text in a notes section.

DIN-rail based switching power supply with universal input 185...550 Vac single/2 /3-phase for industrial automation and process control applications. Input circuit technology makes these immune to overvoltage caused by faults in 3-phase networks with neutral, increasing the reliability of application. This series offers **greater reliability in industrial environments** compared to single-phase power supplies. The input stage uses components with an operating voltage of 900 V, offering greater resistance to the voltage peaks present in industrial networks than single-phase components. The ability to operate from 185 to 550 Vac allows these power supplies to be used in both 230 V single-phase networks and 400 V 3-phase networks.

Suggested uses

- Wherever maximum flexibility of use is required in single- or 3-phase networks
- Applications in industrial automation and process control
- Uses with heavy loads
- Civil automation applications

Main features

- The 185...550 Vac extended range input is compatible with 230...240 Vac single-phase power, 208 Vac 2-phase and 400...500 Vac 2-phase and 3-phase for maximum adaptability to AC networks, eliminating the need for an isolation transformer.
- The 2-phase input offers reduced bulk, wiring, installation costs and panel space.
- Eliminates the need for a network voltage adaptation transformer.
- Versions with DC OK failure contact
- High efficiency reduces energy consumption and the operating temperature of components and allows use in small panels and severe environmental conditions.
- Large power reserve allows 5 seconds of current to be supplied at least +50% higher than the rated value, ensuring safety and reliability.
- The output is adjustable and protected against incoming surge from the DC line, and is equipped with electronic protection that turns off the output in case of an internal malfunction.
- Short-circuit and overload protection designed to supply peak currents of more than 150% of the rated value required by heavy loads, while the thermal protection prevents faults in case of prolonged overload with high ambient temperatures.
- Construction ensures excellent ventilation capacity of internal components, with reduced sizes and a degree of protection from accidental contacts of IP20 per IEC529.
- Thanks to their high performance and excellent ventilation, they are among the smallest on the market.

UNIVERSAL POWER

Greater reliability

This series offers greater reliability in industrial environments compared to single-phase power supplies. The input stage uses components with an operating voltage of 900 V, offering greater resistance to the voltage peaks present in industrial networks than single-phase components.

The ability to operate from 185 to 550 Vac makes these power supplies immune to network faults:

With the output powered at 230 Vac (1L-N), in case of a short in another device connected to L2-N, the neutral is increased to around 400 Vac and the input is powered phase-phase until the protection is opened, which in most cases occurs within 300 ms; this is one of the most frequent causes of malfunction in 230 Vac single-phase power supplies in industrial environments (figures 1 and 2)

Another type of fault in 230 Vac single-phase devices with phase-neutral power is due to the accidental disconnection or interruption of the panel neutral by the plant neutral: with no return to the star point, the neutral increases to phase voltage and applies to single-phase loads of around 400 Vac, and malfunction is inevitable.

185...550 Vac wide range input

Compatible with 230...240 Vac single-phase power, 208 Vac 2-phase and 400...500 Vac 2-phase and 3-phase for maximum adaptability to AC networks, eliminating the need for an isolation transformer.

Power boost

The output power reaches 120% of the nominal value for several minutes, up to 150% in the event of overload, and up to 250% during a short-circuit, to enable the protection devices connected to the output to trigger quickly, safely and selectively, without the use of additional modules.

High performance

Reduces the energy consumption and operating temperature of components and allows for use in small panels

Increased reliability in industrial environments

The input stage uses components with an operating voltage of 900 V, more resistant to the voltage peaks found in industrial networks

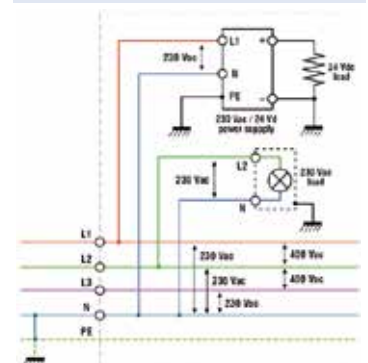
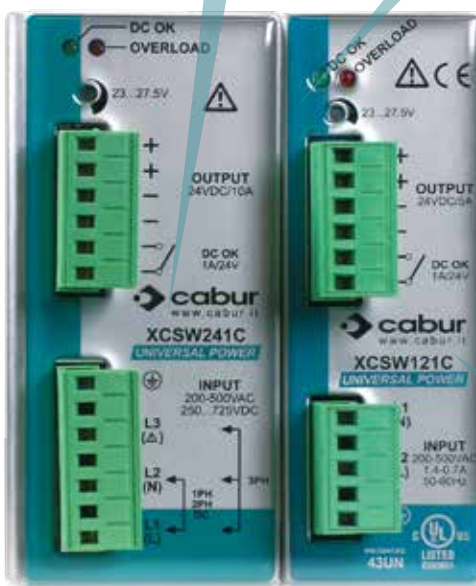

Typical application with 3-phase network with neutral. This is used to obtain a voltage of 230 Vac to power loads (a single lamp in the example) and power supplies.

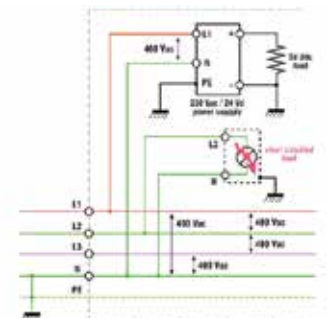

A single short-circuit on the load will raise the neutral potential and all devices connected to it will be powered between two phases, i.e. at around 340...400 Vac rather than 230 Vac.





- Single phase and 2-phase input
- Short circuit, overload, input and output overvoltage protections
- Over temperature protection
- Suitable for applications that require high reliability and performance
- Smart alarm contact, signals when output voltage drops more than 10%
- High overload capability to ensure the protections selectivity and start-up of heavy loads

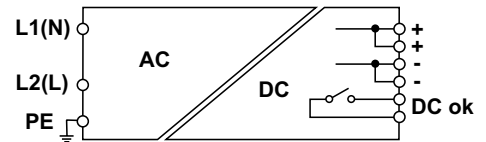
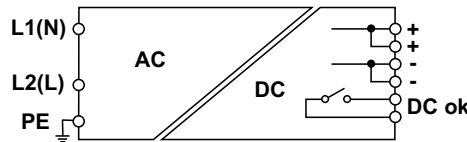

NOTE

Please refer to the datasheet for more details
Above overcurrent limit, the protection starts cycling in ON/OFF mode(hiccup autoreset), the maximum current supplied depends by the line resistance







CODE	XCSW121C	XCSW121B
TYPE	CSW121C	CSW121B
INPUT TECHNICAL DATA		
Input rated voltage	1-2x 230-400-500 Vac	1-2x 230-400-500 Vac
Input voltage AC	187...550 Vac	187...550 Vac
Input voltage DC	270...725 Vdc	270...725 Vdc
Frequency	47...63 Hz	47...63 Hz
Current consumption	1.1 A (230 Vac) / 0.55 A (400 Vac)	1.1 A (230 Vac) / 0.55 A (400 Vac)
Inrush peak current	20 A	20 A
Power factor	> 0.65	> 0.65
Internal protection fuse	—	—
External protection on AC line	MCB: C-6 A / Fuse: T-4 A	MCB: C-6 A / Fuse: T-4 A
OUTPUT TECHNICAL DATA		
Output rated voltage	24 Vdc ±1%	12 Vdc ±1%
Output adjustable range	24...27.5 Vdc	12...15 Vdc
Continuous current	5 A	8 A (12 Vdc) - 7 A (15 Vdc)
Overload limiting	7.5 A for >30 s	10 A for >30 s
Short circuit peak current	14 A for 0.4 s	20 A for 0.4 s
Ripple @ nominal ratings	100 mVpp	100 mVpp
Hold up time	20 ms (230 Vac) / 80 ms (400 Vac)	20 ms (230 Vac) / 80 ms (400 Vac)
Status indication	LED "DC OK" / LED "Alarm"	LED "DC OK" / LED "Alarm"
Alarm contact	dry contact, max. 1A @ 24 Vdc (Uout >21.6 Vdc)	dry contact, max. 1A @ 24 Vdc (Uout >10.8 Vdc)
Parallel connection	possible	possible
Redundant parallel connection	possible with external ORing diode	possible with external ORing diode
GENERAL TECHNICAL DATA		
Efficiency	87% (230 Vac) / 87% (400 Vac)	84% (230 Vac) / 86% (400 Vac)
Dissipated power	18 W (230 Vac) / 18 W (400 Vac)	20 W (230 Vac) / 17 W (400 Vac)
Operating temperature range	-20...+60°C (derating -3 W >45°C)	-20...+60°C (derating -3 W >45°C)
Input / output isolation	3 kVac / 60 s (SELV output)	3 kVac / 60 s (SELV output)
Input / ground isolation	1.5 kVac / 60 s	1.5 kVac / 60 s
Output / ground isolation	0.5 kVac / 60 s	0.5 kVac / 60 s
Standard / approvals	EN 60950-1	EN 60950-1
EMC Standards	EN 61000-6-1, EN 61000-6-2, EN 61000-6-3, EN 61000-6-4	EN 61000-6-1, EN 61000-6-2, EN 61000-6-3, EN 61000-6-4
Overvoltage category / Pollution degree	II / 2	II / 2
Protection degree	IP 20	IP 20
Connection terminal IN/OUT	2.5 mm ² / 2.5 mm ²	2.5 mm ² / 2.5 mm ²
Housing material	aluminium	aluminium
Dimension	40x130x115 mm	40x130x115 mm
Approximate weight	600 g	600 g
Mounting information	vertical on a rail, 10 mm from adjacent components	vertical on a rail, 10 mm from adjacent components
APPROVALS	 	 
ACCESSORIES		
Mounting rail (IEC60715/TH35-7.5)	PR/3/AC, PR/3/AC/ZB, PR/3/AS, PR/3/AS/ZB	PR/3/AC, PR/3/AC/ZB, PR/3/AS, PR/3/AS/ZB
Mounting rail (IEC60715/TH35-15)	PR/3/PP, PR/3/PP/ZB, PR/3/PA, PR/3/PA/ZB	PR/3/PP, PR/3/PP/ZB, PR/3/PA, PR/3/PA/ZB
Marking tag	—	—

- Single phase, 2-phase and 3-phase input
- Short circuit, overload, input and output overvoltage protections
- Over temperature protection
- Suitable for applications that require high reliability and performance
- Smart alarm contact, signals when output voltage drops more than 10%
- High overload capability to ensure the protections selectivity and start-up of heavy loads

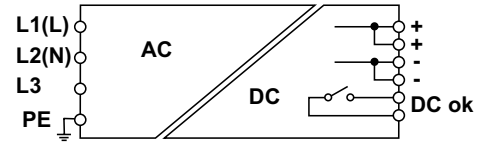
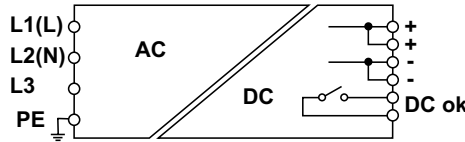

NOTE
Please refer to the datasheet for more details
Above overcurrent limit, the protection starts cycling in ON/OFF mode(hiccup autoreset), the maximum current supplied depends by the line resistance



CODE	XCSW241C	XCSW241B
TYPE	CSW241C	CSW241B
INPUT TECHNICAL DATA		
Input rated voltage	1-2-3x 230-400-500 Vac	1-2-3x 230-400-500 Vac
Input voltage AC	185...550 Vac	185...550 Vac
Input voltage DC	270...770 Vdc	270...770 Vdc
Frequency	47...63 Hz	47...63 Hz
Current consumption	2 A (230 Vac) / 1 A (400 Vac)	2 A (230 Vac) / 1 A (400 Vac)
Inrush peak current	20 A	20 A
Power factor	> 0.65	> 0.65
Internal protection fuse	—	—
External protection on AC line	MCB: C-6 A / Fuse: T-6.3 A	MCB: C-6 A / Fuse: T-6.3 A
OUTPUT TECHNICAL DATA		
Output rated voltage	24 Vdc ±1%	12 Vdc ±1%
Output adjustable range	24...27.5 Vdc	12...15 Vdc
Continuous current	10 A at 50°C	16 A (12 Vdc) - 15 A (15 Vdc)
Overload limiting	15 A for >6 s	20...18 A for >6 s
Short circuit peak current	38 A for 0.5 s	34 A for 0.5 s
Ripple @ nominal ratings	100 mVpp	100 mVpp
Hold up time	15 ms (230 Vac) / 100 ms (400 Vac)	15 ms (230 Vac) / 100 ms (400 Vac)
Status indication	LED "DC OK" / LED "Alarm"	LED "DC OK" / LED "Alarm"
Alarm contact	dry contact, max. 1A @ 24 Vdc (Uout >21.6 Vdc)	dry contact, max. 1A @ 24 Vdc (Uout >10.8 Vdc)
Parallel connection	possible	possible
Redundant parallel connection	possible with external ORing diode	possible with external ORing diode
GENERAL TECHNICAL DATA		
Efficiency	91% (230 Vac) / 92% (400 Vac)	89% (230 Vac) / 90% (400 Vac)
Dissipated power	24 W (230 Vac) / 21 W (400 Vac)	22 W (230 Vac) / 20 W (400 Vac)
Operating temperature range	-20...+60°C (derating -3 W >50°C)	-20...+60°C (derating -3 W >50°C)
Input / output isolation	3 kVac / 60 s (SELV output)	3 kVac / 60 s (SELV output)
Input / ground isolation	2 kVac / 60 s	2 kVac / 60 s
Output / ground isolation	0.5 kVac / 60 s	0.5 kVac / 60 s
Standard / approvals	EN 60950-1	EN 60950-1
EMC Standards	EN 61000-6-1, EN 61000-6-2, EN 61000-6-3, EN 61000-6-4	EN 61000-6-1, EN 61000-6-2, EN 61000-6-3, EN 61000-6-4
Overvoltage category / Pollution degree	II / 2	II / 2
Protection degree	IP 20	IP 20
Connection terminal IN/OUT	2.5 mm ² / 2.5 mm ²	2.5 mm ² / 2.5 mm ²
Housing material	aluminium	aluminium
Dimension	55x130x115 mm	55x130x115 mm
Approximate weight	1 kg	1 kg
Mounting information	vertical on a rail, 10 mm from adjacent components	vertical on a rail, 10 mm from adjacent components
APPROVALS	 	 
ACCESSORIES		
Mounting rail (IEC60715/TH35-7.5)	PR/3/AC, PR/3/AC/ZB, PR/3/AS, PR/3/AS/ZB	PR/3/AC, PR/3/AC/ZB, PR/3/AS, PR/3/AS/ZB
Mounting rail (IEC60715/TH35-15)	PR/3/PP, PR/3/PP/ZB, PR/3/PA, PR/3/PA/ZB	PR/3/PP, PR/3/PP/ZB, PR/3/PA, PR/3/PA/ZB
Marking tag	—	—

- Single phase, 2-phase and 3-phase input
- Short circuit, overload, input and output overvoltage protections
- Over temperature protection
- Suitable for applications that require high reliability and performance
- Smart alarm contact, signals when output voltage drops more than 10%
- High overload capability to ensure the protections selectivity and start-up of heavy loads



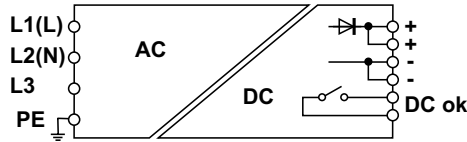

NOTE

Please refer to the datasheet for more details
Above overcurrent limit, the protection starts cycling in ON/OFF mode(hiccup autoreset), the maximum current supplied depends by the line resistance



Until stocks are exhausted





CODE	XCSW241DP
TYPE	CSW241DP
INPUT TECHNICAL DATA	
Input rated voltage	1-2-3x 230-400-500 Vac
Input voltage AC	185...550 Vac
Input voltage DC	270...770 Vdc
Frequency	47...63 Hz
Current consumption	2 A (230 Vac) / 1 A (400 Vac)
Inrush peak current	20 A
Power factor	> 0.65
Internal protection fuse	—
External protection on AC line	MCB: C-6 A / Fuse: T-6.3 A
OUTPUT TECHNICAL DATA	
Output rated voltage	48 Vdc ±1%
Output adjustable range	45...55 Vdc
Continuous current	5 A at 50°C
Overload limiting	6 A for >6 s
Short circuit peak current	18 A for 0.5 s
Ripple @ nominal ratings	100 mVpp
Hold up time	15 ms (230 Vac) / 100 ms (400 Vac)
Status indication	LED "DC OK" / LED "Alarm"
Alarm contact	dry contact, max. 1A @ 24 Vdc (Uout >43.2 Vdc)
Parallel connection	possible
Redundant parallel connection	already fitted with internal ORing diode
GENERAL TECHNICAL DATA	
Efficiency	91% (230 Vac) / 92% (400 Vac)
Dissipated power	24 W (230 Vac) / 21 W (400 Vac)
Operating temperature range	-20...+60°C (derating -3 W >50°C)
Input / output isolation	3 kVac / 60 s (SELV output)
Input / ground isolation	2 kVac / 60 s
Output / ground isolation	0.5 kVac / 60 s
Standard / approvals	EN 60950-1
EMC Standards	EN 61000-6-1, EN 61000-6-2, EN 61000-6-3, EN 61000-6-4
Overvoltage category / Pollution degree	II / 2
Protection degree	IP 20
Connection terminal IN/OUT	2.5 mm ² / 2.5 mm ²
Housing material	aluminium
Dimension	55x130x115 mm
Approximate weight	1 kg
Mounting information	vertical on a rail, 10 mm from adjacent components
APPROVALS	 
ACCESSORIES	
Mounting rail (IEC60715/TH35-7.5)	PR/3/AC, PR/3/AC/ZB, PR/3/AS, PR/3/AS/ZB
Mounting rail (IEC60715/TH35-15)	PR/3/PP, PR/3/PP/ZB, PR/3/PA, PR/3/PA/ZB
Marking tag	—

- Single phase, 2-phase and 3-phase input
- Short circuit, overload, input and output overvoltage protections
- Over temperature protection
- Suitable for applications that require high reliability and performance
- Smart alarm contact, signals when output voltage drops more than 10%
- High overload capability to ensure the protections selectivity and start-up of heavy loads

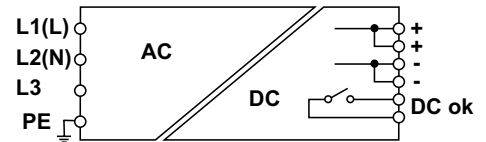
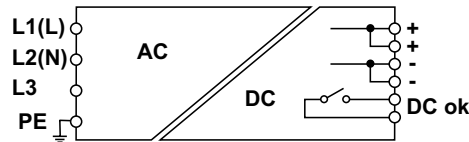

NOTE
Please refer to the datasheet for more details
Above overcurrent limit, the protection starts cycling in ON/OFF mode(hiccup autoreset), the maximum current supplied depends by the line resistance



CODE	XCSW481C	XCSW481D
TYPE	CSW481C	CSW481D
INPUT TECHNICAL DATA		
Input rated voltage	1-2-3x 230-400-500 Vac	1-2-3x 230-400-500 Vac
Input voltage AC	187...550 Vac	187...550 Vac
Input voltage DC	250...725 Vdc	250...725 Vdc
Frequency	47...63 Hz	47...63 Hz
Current consumption	2.2 A (230 Vac) / 1 A (400 Vac)	2.2 A (230 Vac) / 1 A (400 Vac)
Inrush peak current	20 A (230 Vac) / 40 A (500 Vac)	20 A (230 Vac) / 40 A (500 Vac)
Power factor	> 0.95	> 0.95
Internal protection fuse	—	—
External protection on AC line	MCB: C-6 A / Fuse: T-6.3 A	MCB: C-6 A / Fuse: T-6.3 A
OUTPUT TECHNICAL DATA		
Output rated voltage	24 Vdc ±1%	48 Vdc ±1%
Output adjustable range	23.3...27.5 Vdc	45...55 Vdc
Continuous current	20 A at 45°C	10 A at 45°C
Overload limiting	28 A for >5 s	14 A for >5 s
Short circuit peak current	50 A for 0.3 s	25 A for 0.3 s
Ripple @ nominal ratings	100 mVpp	100 mVpp
Hold up time	20 ms (230 Vac) / 20 ms (400 Vac)	20 ms (230 Vac) / 20 ms (400 Vac)
Status indication	LED "DC OK" / LED "Alarm"	LED "DC OK" / LED "Alarm"
Alarm contact	dry contact, max. 1A @ 24 Vdc (Uout >21.6 Vdc)	dry contact, max. 1A @ 24 Vdc (Uout >43.2 Vdc)
Parallel connection	possible	possible
Redundant parallel connection	possible with external ORing diode	possible with external ORing diode
GENERAL TECHNICAL DATA		
Efficiency	92% (230 Vac) / 92% (400 Vac)	92% (230 Vac) / 92% (400 Vac)
Dissipated power	42 W (230 Vac) / 42 W (400 Vac)	42 W (230 Vac) / 42 W (400 Vac)
Operating temperature range	-20...+60°C (derating -16 W >45°C)	-20...+60°C (derating -16 W >45°C)
Input / output isolation	3 kVac / 60 s (SELV output)	3 kVac / 60 s (SELV output)
Input / ground isolation	2 kVac / 60 s	2 kVac / 60 s
Output / ground isolation	0.5 kVac / 60 s	0.5 kVac / 60 s
Standard / approvals	EN 60950-1	EN 60950-1
EMC Standards	EN 61000-6-2, EN 61000-6-4	EN 61000-6-2, EN 61000-6-4
Overvoltage category / Pollution degree	II / 2	II / 2
Protection degree	IP 20	IP 20
Connection terminal IN/OUT	2.5 mm ² / 2.5 mm ²	2.5 mm ² / 2.5 mm ²
Housing material	aluminium	aluminium
Dimension	73x137x140 mm	73x137x140 mm
Approximate weight	1 kg	1 kg
Mounting information	vertical on a rail, 10 mm from adjacent components	vertical on a rail, 10 mm from adjacent components
APPROVALS	 	 
ACCESSORIES		
Mounting rail (IEC60715/TH35-7.5)	PR/3/AC, PR/3/AC/ZB, PR/3/AS, PR/3/AS/ZB	PR/3/AC, PR/3/AC/ZB, PR/3/AS, PR/3/AS/ZB
Mounting rail (IEC60715/TH35-15)	PR/3/PP, PR/3/PP/ZB, PR/3/PA, PR/3/PA/ZB	PR/3/PP, PR/3/PP/ZB, PR/3/PA, PR/3/PA/ZB
Marking tag	—	—

- Single phase, 2-phase and 3-phase input
- Short circuit, overload, input and output overvoltage protections
- Over temperature protection
- Suitable for applications that require high reliability and performance
- Smart alarm contact, signals when output voltage drops more than 10%
- High overload capability to ensure the protections selectivity and start-up of heavy loads



NOTE
Please refer to the datasheet for more details
Above overcurrent limit, the protection starts cycling in ON/OFF mode(hiccup autoreset), the maximum current supplied depends by the line resistance

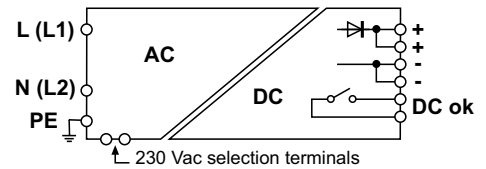
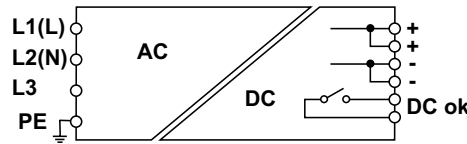

CODE	XCSW481G	XCSW960CP
TYPE	CSW481G	CSW960CP
INPUT TECHNICAL DATA		
Input rated voltage	1-2-3x 230-400-500 Vac	1x 230 Vac / 2x 400-500 Vac
Input voltage AC	187...550 Vac	180...264 Vac / 360...550 Vac (1)
Input voltage DC	250...725 Vdc	550...775 Vdc
Frequency	47...63 Hz	47...63 Hz
Current consumption	2.2 A (230 Vac) / 1 A (400 Vac)	4.7A (230 Vac) / 4A (400 Vac)
Inrush peak current	20 A (230 Vac) / 40 A (500 Vac)	16 A
Power factor	> 0.95	> 0.6
Internal protection fuse	—	—
External protection on AC line	MCB: C-6 A / Fuse: T-6.3 A	MCB: C-10 A / Fuse: 1-2x T 10 A
OUTPUT TECHNICAL DATA		
Output rated voltage	72 Vdc ±1%	24 Vdc ±1%
Output adjustable range	72...85 Vdc	23...27.5 Vdc
Continuous current	6 A at 45°C	40 A at 45°C
Overload limiting	9 A for >5 s	50 A for >5 s
Short circuit peak current	12 A for 0.3 s	65 A for 5 s
Ripple @ nominal ratings	100 mVpp	200 mVpp
Hold up time	20 ms (230 Vac) / 20 ms (400 Vac)	20 ms (230 Vac) / 20 ms (400 Vac)
Status indication	LED "DC OK" / LED "Alarm"	LED "DC OK" / LED "Alarm"
Alarm contact	dry contact, max. 1A @ 24 Vdc (Uout >68.4 Vdc)	dry contact, max. 1A @ 24 Vdc (Uout >21.6 Vdc)
Parallel connection	possible	possible
Redundant parallel connection	possible with external ORing diode	already fitted with internal ORing diode
GENERAL TECHNICAL DATA		
Efficiency	91% (230 Vac) / 91% (400 Vac)	90% (400 Vac) at 230 Vac
Dissipated power	42 W (230 Vac) / 42 W (400 Vac)	<100 W (400 Vac) at 230 Vac
Operating temperature range	-20...+60°C (derating -16 W >45°C)	-20...+60°C (derating -32 W >45°C)
Input / output isolation	3 kVac / 60 s (no SELV output)	3 kVac / 60 s (SELV output)
Input / ground isolation	2 kVac / 60 s	2 kVac / 60 s
Output / ground isolation	0.5 kVac / 60 s	0.5 kVac / 60 s
Standard / approvals	EN 60950-1	EN 60950-1
EMC Standards	EN 61000-6-2, EN 61000-6-4	EN 61000-6-2, EN 61000-6-4
Overvoltage category / Pollution degree	II / 2	II / 2
Protection degree	IP 20	IP 20
Connection terminal IN/OUT	2.5 mm ² / 2.5 mm ²	4 mm ² / 10 mm ²
Housing material	aluminium	aluminium
Dimension	73x137x140 mm	80x139x127 mm
Approximate weight	1 kg	1.2 Kg
Mounting information	vertical on a rail, 10 mm from adjacent components	vertical on a rail, 10 mm from adjacent components
APPROVALS		
ACCESSORIES		
Mounting rail (IEC60715/TH35-7.5)	PR/3/AC, PR/3/AC/ZB, PR/3/AS, PR/3/AS/ZB	PR/3/AC, PR/3/AC/ZB, PR/3/AS, PR/3/AS/ZB
Mounting rail (IEC60715/TH35-15)	PR/3/PP, PR/3/PP/ZB, PR/3/PA, PR/3/PA/ZB	PR/3/PP, PR/3/PP/ZB, PR/3/PA, PR/3/PA/ZB
Marking tag	—	TAP207A , TAP128A , TAP178A , TAP209A

400...500 Vac 3-phase switching power supply for industrial automation applications. They can deliver over +50% of nominal current for a sustained period, keeping the output voltage stable and ensuring continuity of supply to the system. Equipped with voltage threshold controlled failure contact which is triggered when the voltage falls below 90% of the rated value.

With these features and numerous international certifications, this range of power supplies enables designers to meet the requirements of the Machinery Directive EN 60204-1, allowing the protection devices connected to the output to trigger quickly, safely and selectively, thus ensuring continuity of service to the other parts of the system.

Suggested uses

- Applications in machine automation with high command and control voltage reliability and safety requirements
- In applications which require selectable overcurrent protections on DC lines
- Industrial automation applications
- Uses with heavy loads

Main features

- With 340...550 Vac/507...770 Vdc input, making them suitable for use on all power supply networks.
- High efficiency reduces energy consumption and the operating temperature of components and allows use in small panels and severe environmental conditions.
- Large power reserve allows for delivery of at least +50% of nominal current for 5 seconds maintaining the output voltage stable, ensuring safety and reliability.
- Output voltage is adjustable and protected against incoming surge from the DC line, and is equipped with a double electronic protection that prevents damage to the powered device in case of an internal malfunction.
- Short-circuit and overload protection designed to deliver peak currents more than 150% higher than the rated value required by heavy loads.
- Thermal protection prevents faults in case of prolonged overload with high ambient temperatures.
- Construction ensures optimal capacity of ventilation of internal components, extremely reduced overall dimensions and degree of protection IP20 by accidental contact according to IEC529.

TRIPLE POWER

Special power supplies for engines DC, Brushless, and relative drives

New 48Vdc, 72-85Vdc, and 110-180Vdc models have been introduced, designed to reliably power engines in DC. They:

- supply peak power equal to even 4-5 times the nominal current, which is required by the engine during the peak phase
- have an output stage protected from overvoltage generated by the engines and drives during braking, which could otherwise cause malfunctions or cause the power supply to lose control over output voltage stability
- Provide output voltage at 48Vdc, and 72...85Vdc. By increasing the voltage of the engine power supply, the same power can be obtained at lower current, with notable advantages for performance, engine construction, connection wires, and drives.

Integrated smart alarm contact
Notifies when the output voltage falls below 90% of the rated value once a threshold is surpassed

Super compact size

Power boost
The output power reaches 120% of the nominal value for several minutes, up to 150% in the event of overload, and up to 250% during a short-circuit, to enable the protection devices connected to the output to trigger quickly, safely and selectively, without the use of additional modules.



Wide range
Designed to save energy and reduce operating temperature





Wide range
The widest range on the market, with power ratings from 120 to 2400W and output voltages of 24, 48 and 72 V, for uses including powering special motors

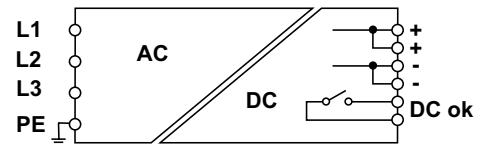
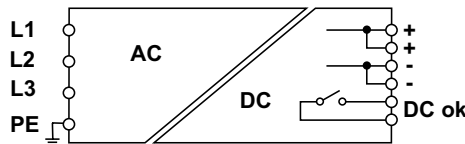

- 3-phase 400-500 Vac input or 2-phase with derating
- Short circuit, overload, input and output overvoltage protections
- Over temperature protection
- Suitable for applications that require high reliability and performance
- Smart alarm contact, signals when output voltage drops more than 10%
- High overload capability to ensure the protections selectivity and start-up of heavy loads





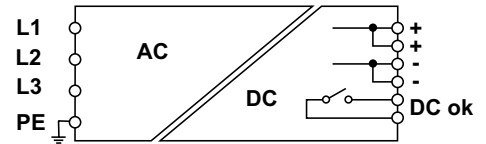
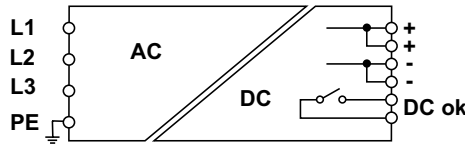

NOTE
Please refer to the datasheet for more details
Above overcurrent limit, the protection starts cycling in ON/OFF mode (hiccup autoreset), the maximum current supplied depends by the line resistance

CODE	XCSG481C	XCSG500C
TYPE	CSG481C	CSG500C
INPUT TECHNICAL DATA		
Input rated voltage	3x 400–500 Vac	3x 400–500 Vac
Input voltage AC	340...550 Vac	340...550 Vac
Input voltage DC	—	—
Frequency	47...63 Hz	47...63 Hz
Current consumption	1.2 A (400 Vac) / 0.8 A (500 Vac)	1 A (400 Vac) / 0.6 A (500 Vac)
Inrush peak current	40 A	35 A
Power factor	> 0.95	> 0.75
Internal protection fuse	—	—
External protection on AC line	MCB: C-6 A / Fuse: T-6.3 A	MCB: C-10 A / Fuse: T-10 A
OUTPUT TECHNICAL DATA		
Output rated voltage	24 Vdc ±1%	24 Vdc ±1%
Output adjustable range	23.3...27.5 Vdc	24...28 Vdc
Continuous current	20 A at 45°C	20 A at 50°C
Overload limiting	28 A for >5 s	>22 A for >5 s
Short circuit peak current	50 A for 0.3 s	35 A for 5 s
Ripple @ nominal ratings	100 mVpp	100 mVpp
Hold up time	50 ms (400 Vac) / 50 ms (500 Vac)	15 ms (400 Vac) / 30 ms (500 Vac)
Status indication	LED "DC OK"	LED "DC OK" / LED "Alarm"
Alarm contact	dry contact, max. 1A @ 24 Vdc (Uout >21.6 Vdc)	dry contact, max. 1A @ 24 Vdc (Uout >21.6 Vdc)
Parallel connection	possible	possible
Redundant parallel connection	possible with external ORing diode	possible with external ORing diode
GENERAL TECHNICAL DATA		
Efficiency	93% (400 Vac) / 92% (500 Vac)	93% (400 Vac) / 93% (500 Vac)
Dissipated power	36 W (400 Vac) / 42 W (500 Vac)	36 W (400 Vac) / 36 W (500 Vac)
Operating temperature range	-20...+60°C (derating -16 W >45°C)	-20...+60°C (derating -6 W >50°C)
Input / output isolation	3 kVac / 60 s (SELV output)	3 kVac / 60 s (SELV output)
Input / ground isolation	2 kVac / 60 s	2 kVac / 60 s
Output / ground isolation	0.5 kVac / 60 s	0.5 kVac / 60 s
Standard / approvals	EN 60950-1	EN 60950-1
EMC Standards	EN 61000-6-2, EN 61000-6-4	EN 61000-6-1, EN 61000-6-2, EN 61000-6-3, EN 61000-6-4
Overvoltage category / Pollution degree	II / 2	II / 2
Protection degree	IP 20	IP 20
Connection terminal IN/OUT	2.5 mm ² / 2.5 mm ²	4 mm ² / 4 mm ²
Housing material	aluminium	aluminium
Dimension	73x137x140 mm	80x139x127 mm
Approximate weight	1 kg	1.3 Kg
Mounting information	vertical on a rail, 10 mm from adjacent components	vertical on a rail, 10 mm from adjacent components
APPROVALS	 	 
ACCESSORIES		
Mounting rail (IEC60715/TH35-7.5)	PR/3/AC, PR/3/AC/ZB, PR/3/AS, PR/3/AS/ZB	PR/3/AC, PR/3/AC/ZB, PR/3/AS, PR/3/AS/ZB
Mounting rail (IEC60715/TH35-15)	PR/3/PP, PR/3/PP/ZB, PR/3/PA, PR/3/PA/ZB	PR/3/PP, PR/3/PP/ZB, PR/3/PA, PR/3/PA/ZB
Marking tag	—	TAP207A, TAP128A, TAP178A, TAP209A

- 3-phase 400-500 Vac input or 2-phase with derating
- Short circuit, overload, input and output overvoltage protections
- Over temperature protection
- Suitable for applications that require high reliability and performance
- Smart alarm contact, signals when output voltage drops more than 10%
- High overload capability to ensure the protections selectivity and start-up of heavy loads





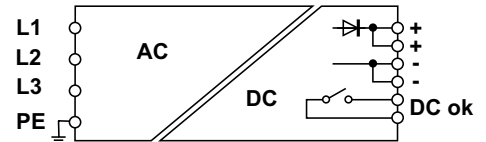
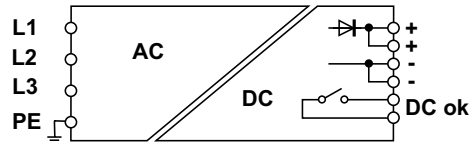

NOTE
Please refer to the datasheet for more details
Above overcurrent limit, the protection starts cycling in ON/OFF mode (hiccup autoreset), the maximum current supplied depends by the line resistance

CODE	XCSG720C	XCSG960C
TYPE	CSG720C	CSG960C
INPUT TECHNICAL DATA		
Input rated voltage	3x 400-500 Vac	3x 400-500 Vac
Input voltage AC	340...550 Vac	340...550 Vac
Input voltage DC	—	—
Frequency	47...63 Hz	47...63 Hz
Current consumption	1.4 A (400 Vac) / 1.1 A (500 Vac)	2.2 A (400 Vac) / 1.1 A (500 Vac)
Inrush peak current	30 A	20 A
Power factor	> 0.75	> 0.65
Internal protection fuse	—	—
External protection on AC line	MCB: C-10 A / Fuse: T-10 A	MCB: C-10 A / Fuse: T-10 A
OUTPUT TECHNICAL DATA		
Output rated voltage	24 Vdc ±1%	24 Vdc ±1%
Output adjustable range	24...28 Vdc	24...28 Vdc
Continuous current	30 A at 50°C	40 A at 50°C
Overload limiting	45 A for > 5 s	44 A for >5 s
Short circuit peak current	60 A for 1.5 s	63 A for 5 s
Ripple @ nominal ratings	100 mVpp	100 mVpp
Hold up time	10 ms (400 Vac) / 15 ms (500 Vac)	10 ms (400 Vac) / 15 ms (500 Vac)
Status indication	LED "DC OK" / LED "Alarm"	LED "DC OK" / LED "Alarm"
Alarm contact	dry contact, max. 1A @ 24 Vdc (Uout >21.6 Vdc)	dry contact, max. 1A @ 24 Vdc (Uout >21.6 Vdc)
Parallel connection	possible	possible
Redundant parallel connection	possible with external ORing diode	possible with external ORing diode
GENERAL TECHNICAL DATA		
Efficiency	92% (400 Vac) / 92% (500 Vac)	92% (400 Vac) / 92% (500 Vac)
Dissipated power	60 W (400 Vac) / 60 W (500 Vac)	80 W (400 Vac) / 80 W (500 Vac)
Operating temperature range	-20...+60°C	-20...+60°C (derating -18 W >45°C)
Input / output isolation	3 kVac / 60 s (SELV output)	3 kVac / 60 s (SELV output)
Input / ground isolation	2 kVac / 60 s	2 kVac / 60 s
Output / ground isolation	0.5 kVac / 60 s	0.5 kVac / 60 s
Standard / approvals	EN 60950-1	EN 60950-1
EMC Standards	EN 61000-6-1, EN 61000-6-2, EN 61000-6-3, EN 61000-6-4	EN 61000-6-1, EN 61000-6-2, EN 61000-6-3, EN 61000-6-4
Overvoltage category / Pollution degree	II / 2	II / 2
Protection degree	IP 20	IP 20
Connection terminal IN/OUT	4 mm ² / 4 mm ²	4 mm ² / 10 mm ²
Housing material	aluminium	aluminium
Dimension	80x139x127 mm	80x139x127 mm
Approximate weight	1.3 Kg	1.2 kg
Mounting information	vertical on a rail, 10 mm from adjacent components	vertical on a rail, 10 mm from adjacent components
APPROVALS	 	 
ACCESSORIES		
Mounting rail (IEC60715/TH35-7.5)	PR/3/AC, PR/3/AC/ZB, PR/3/AS, PR/3/AS/ZB	PR/3/AC, PR/3/AC/ZB, PR/3/AS, PR/3/AS/ZB
Mounting rail (IEC60715/TH35-15)	PR/3/PP, PR/3/PP/ZB, PR/3/PA, PR/3/PA/ZB	PR/3/PP, PR/3/PP/ZB, PR/3/PA, PR/3/PA/ZB
Marking tag	TAP207A, TAP128A, TAP178A, TAP209A	TAP207A, TAP128A, TAP178A, TAP209A

- 3-phase 400-500 Vac input or 2-phase with derating
- Short circuit, overload, input and output overvoltage protections
- Over temperature protection
- Suitable for applications that require high reliability and performance
- Smart alarm contact, signals when output voltage drops more than 10%
- High overload capability to ensure the protections selectivity and start-up of heavy loads



NOTE
Please refer to the datasheet for more details
Above overcurrent limit, the protection starts cycling in ON/OFF mode (hiccup autoreset), the maximum current supplied depends by the line resistance

CODE	XCSG960D	XCSG960G
TYPE	CSG960D	CSG960G
INPUT TECHNICAL DATA		
Input rated voltage	3x 400-500 Vac	3x 400-500 Vac
Input voltage AC	340...550 Vac	340...550 Vac
Input voltage DC	—	—
Frequency	47...63 Hz	47...63 Hz
Current consumption	2.2 A (400 Vac) / 1.1 A (500 Vac)	2.2 A (400 Vac) / 1.1 A (500 Vac)
Inrush peak current	20 A	20 A
Power factor	> 0.65	> 0.65
Internal protection fuse	—	—
External protection on AC line	MCB: C-10 A / Fuse: T-10 A	MCB: C-10 A / Fuse: T-10 A
OUTPUT TECHNICAL DATA		
Output rated voltage	48 Vdc ±1%	72 Vdc ±1%
Output adjustable range	45...55 Vdc	72...85 Vdc
Continuous current	20 A at 50°C	13.3 A at 50°C
Overload limiting	23 A for >5 s	17 A for >5 s
Short circuit peak current	40 A for 5 s	27 A for 5 s
Ripple @ nominal ratings	100 mVpp	100 mVpp
Hold up time	10 ms (400 Vac) / 15 ms (500 Vac)	15 ms (400 Vac) / 18 ms (500 Vac)
Status indication	LED "DC OK" / LED "Alarm"	LED "DC OK" / LED "Alarm"
Alarm contact	dry contact, max. 1A @ 24 Vdc (Uout >43.2 Vdc)	dry contact, max. 1A @ 24 Vdc (Uout >68.4 Vdc)
Parallel connection	possible	possible
Redundant parallel connection	already fitted with internal ORing diode	already fitted with internal ORing diode
GENERAL TECHNICAL DATA		
Efficiency	92% (400 Vac) / 92% (500 Vac)	94% (400 Vac) / 94% (500 Vac)
Dissipated power	80 W (400 Vac) / 80 W (500 Vac)	60 W (400 Vac) / 60 W (500 Vac)
Operating temperature range	-20...+60°C (derating -18 W >45°C)	-20...+60°C (derating -18 W >45°C)
Input / output isolation	3 kVac / 60 s (SELV output)	3 kVac / 60 s (no SELV output)
Input / ground isolation	2 kVac / 60 s	2 kVac / 60 s
Output / ground isolation	0.5 kVac / 60 s	0.5 kVac / 60 s
Standard / approvals	EN 60950-1	EN 60950-1
EMC Standards	EN 61000-6-1, EN 61000-6-2, EN 61000-6-3, EN 61000-6-4	EN 61000-6-1, EN 61000-6-2, EN 61000-6-3, EN 61000-6-4
Overvoltage category / Pollution degree	II / 2	II / 2
Protection degree	IP 20	IP 20
Connection terminal IN/OUT	4 mm ² / 10 mm ²	4 mm ² / 10 mm ²
Housing material	aluminium	aluminium
Dimension	80x139x127 mm	80x139x127 mm
Approximate weight	1.2 kg	1.2 kg
Mounting information	vertical on a rail, 10 mm from adjacent components	vertical on a rail, 10 mm from adjacent components
APPROVALS	 	 
ACCESSORIES		
Mounting rail (IEC60715/TH35-7.5)	PR/3/AC, PR/3/AC/ZB, PR/3/AS, PR/3/AS/ZB	PR/3/AC, PR/3/AC/ZB, PR/3/AS, PR/3/AS/ZB
Mounting rail (IEC60715/TH35-15)	PR/3/PP, PR/3/PP/ZB, PR/3/PA, PR/3/PA/ZB	PR/3/PP, PR/3/PP/ZB, PR/3/PA, PR/3/PA/ZB
Marking tag	TAP207A, TAP128A, TAP178A, TAP209A	TAP207A, TAP128A, TAP178A, TAP209A

- 3-phase 400-500 Vac input
- Short circuit, overload, input and output overvoltage protections
- Over temperature protection
- Suitable for applications that require high reliability and performance
- Smart and programmable alarm contact
- High overload capability to ensure the protections selectivity and start-up of heavy loads

NOTE

Please refer to the datasheet for more details
Overcurrent protection can be set to Hiccup or constant current mode, the maximum current supplied depends by the line resistance

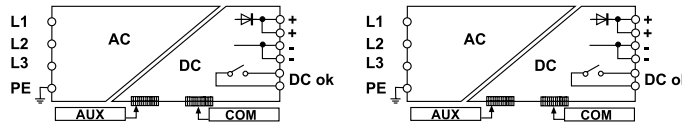

APPLICATIONS

Series CSG2401 has an internal micro-processor that controls the many functions of the power supply, which can be programmed thanks to a user-friendly menu activated by 4 buttons on the front and shown on the front display.

Front display: during normal operation, this shows the output voltage value and current used by the load; during programming, it allows for the choice of the various functions available.

Input protection: the input circuit has been designed to avoid the most common problems seen in 3-phase networks. It therefore has:

- 1) a PFC circuit failure (latched shut-down) circuit
- 2) a system for controlling lack of phase that automatically reduces output power
- 3) an auto-restart switch-off system in the event of overvoltage and undervoltage

Output protection: limit current can be selected as between 10% and 100% of rated current; protection type against overload and short circuit can be chosen from:

- 1) Hiccup auto reset with limit current, equal to 150% of rated current and ON/OFF time can be altered;
- 2) constant power

Output signals: in addition to the "DC OK" and "FAULT" LEDs, the device also has:

- 1) an analogue signal 0...10V or 4...20mA that provides an indication of current used by the load
- 2) a programmable alarm contact able to signal and record the exceeding of the various limits to a memory: output voltage, input current, output overload, over temperature and other parameters that can be defined by programming.

Additional functions:

- 1) Battery charger: the acid lead battery charging function can be selected;
- 2) Remote sensing (sense): this allows for the monitoring and compensation of voltage drops on long power supply lines
- 3) The power supply can be switched off and disabled from a remote position
- 4) Auxiliary voltage: auxiliary 12 Vdc is also available, regardless of the main output voltage status
- 5) Temperature control: by connecting an external sensor (NTC), the battery charge temperature can be controlled.
- 6) Communication port: by means of an RS232 communication device the power supply can be piloted and monitored from a remote position.

CODE	XCSG2401C	XCSG2401D
TYPE	CSG2401C	CSG2401D
INPUT TECHNICAL DATA		
Input rated voltage	3x 400-500 Vac	3x 400-500 Vac
Input voltage AC	340...550 Vac	340...550 Vac
Input voltage DC	—	—
Frequency	47...63 Hz	47...63 Hz
Current consumption	4.2 A (400 Vac) / 3.5 A (500 Vac)	4.2 A (400 Vac) / 3.5 A (500 Vac)
Inrush peak current	10 A (with active limitation circuit)	10 A (with active limitation circuit)
Power factor	> 0.92	> 0.92
Internal protection fuse	—	—
External protection on AC line	MCB: C-10 A / Fuse: T-10 A	MCB: C-10 A / Fuse: T-10 A
OUTPUT TECHNICAL DATA		
Output rated voltage	12-24 Vdc ±1%	24-48 Vdc ±1%
Output adjustable range	11.5...29 Vdc	23...56 Vdc
Continuous current	100 A at 45°C	50 A at 45°C
Overload limiting	150 A for >5 s	75 A for >5 s
Short circuit peak current	150 A for 5 s	75 A for 5 s
Ripple @ nominal ratings	200 mVpp	200 mVpp
Hold up time	10 ms (400 Vac) / 10 ms (500 Vac)	10 ms (400 Vac) / 10 ms (500 Vac)
Status indication	LED "DC OK" / LED "Alarm" / Display	LED "DC OK" / LED "Alarm" / Display
Alarm contact	dry contact, max. 1A @ 24 Vdc (programmable)	dry contact, max. 1A @ 24 Vdc (programmable)
Parallel connection	possible	possible
Redundant parallel connection	already fitted with internal ORing diode	already fitted with internal ORing diode
GENERAL TECHNICAL DATA		
Efficiency	92% (400 Vac) / 92% (500 Vac)	93% (400 Vac) / 93% (500 Vac)
Dissipated power	200 W (400 Vac) / 200 W (500 Vac)	180 W (400 Vac) / 180 W (500 Vac)
Operating temperature range	-20...+60°C (derating -40 W >45°C)	-20...+60°C (derating -40 W >45°C)
Input / output isolation	3 kVac / 60 s (SELV output)	3 kVac / 60 s (SELV output)
Input / ground isolation	1.5 kVac / 60 s	1.5 kVac / 60 s
Output / ground isolation	0.5 kVac / 60 s	0.5 kVac / 60 s
Standard / approvals	EN 60950-1	EN 60950-1
EMC Standards	EN 61000-6-2, EN 61000-6-4	EN 61000-6-2, EN 61000-6-4
Overvoltage category / Pollution degree	II / 2	II / 2
Protection degree	IP 20	IP 20
Connection terminal IN/OUT	4 mm ² / 35 mm ²	4 mm ² / 35 mm ²
Housing material	aluminium	aluminium
Dimension	234x105x130 mm	234x105x130 mm
Approximate weight	2.8 Kg	2.8 Kg
Mounting information	vertical on a rail, 60 mm from adjacent components	vertical on a rail, 60 mm from adjacent components
APPROVALS		
ACCESSORIES		
Mounting rail (IEC60715/TH35-7.5)	PR/3/AC, PR/3/AC/ZB, PR/3/AS, PR/3/AS/ZB	PR/3/AC, PR/3/AC/ZB, PR/3/AS, PR/3/AS/ZB
Mounting rail (IEC60715/TH35-15)	PR/3/PP, PR/3/PP/ZB, PR/3/PA, PR/3/PA/ZB	PR/3/PP, PR/3/PP/ZB, PR/3/PA, PR/3/PA/ZB
Marking tag	TAP207A, TAP128A, TAP178A, TAP209A	TAP207A, TAP128A, TAP178A, TAP209A

- 3-phase 400-500 Vac input
- Short circuit, overload, input and output overvoltage protections
- Over temperature protection
- Suitable for applications that require high reliability and performance
- Smart and programmable alarm contact
- High overload capability to ensure the protections selectivity and start-up of heavy loads

NOTE

Please refer to the datasheet for more details
Overcurrent protection can be set to Hiccup or constant current mode, the maximum current supplied depends by the line resistance
Produced on demand, contact our sales office for availability

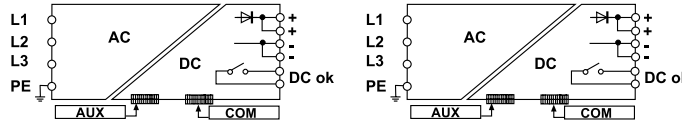

APPLICATIONS

Series CSG2401 has an internal micro-processor that controls the many functions of the power supply, which can be programmed thanks to a user-friendly menu activated by 4 buttons on the front and shown on the front display.

Front display: during normal operation, this shows the output voltage value and current used by the load; during programming, it allows for the choice of the various functions available.

Input protection: the input circuit has been designed to avoid the most common problems seen in 3-phase networks. It therefore has:

- 1) a PFC circuit failure (latched shut-down) circuit
- 2) a system for controlling lack of phase that automatically reduces output power
- 3) an auto-restart switch-off system in the event of overvoltage and under-voltage

Output protection: limit current can be selected as between 10% and 100% of rated current; protection type against overload and short circuit can be chosen from:

- 1) hiccup auto reset with limit current, equal to 150% of rated current and ON/OFF time can be altered;
- 2) Constant power

Output signals: in addition to the "DC OK" and "FAULT" LEDs, the device also has:

- 1) an analogue signal 0...10V or 4...20mA that provides an indication of current used by the load
- 2) a programmable alarm contact able to signal and record the exceeding of the various limits to a memory: output voltage, input current, output overload, over temperature and other parameters that can be defined by programming.

Additional functions:

- 1) Battery charger: the acid lead battery charging function can be selected;
- 2) Remote sensing (sense): this allows for the monitoring and compensation of voltage drops on long power supply lines
- 3) The power supply can be switched off and disabled from a remote position
- 4) Auxiliary voltage: auxiliary 12 Vdc is also available, regardless of the main output voltage status
- 5) Temperature control: by connecting an external sensor (NTC), the battery charge temperature can be controlled.
- 6) Communication port: by means of an RS232 communication device the power supply can be piloted and monitored from a remote position.

CODE	XCSG2401G	XCSG2401R
TYPE	CSG2401G	CSG2401R
INPUT TECHNICAL DATA		
Input rated voltage	3x 400-500 Vac	3x 400-500 Vac
Input voltage AC	340...550 Vac	340...550 Vac
Input voltage DC	—	—
Frequency	47...63 Hz	47...63 Hz
Current consumption	4.2 A (400 Vac) / 3.5 A (500 Vac)	4.2 A (400 Vac) / 3.5 A (500 Vac)
Inrush peak current	10 A (with active limitation circuit)	10 A (with active limitation circuit)
Power factor	> 0.92	> 0.92
Internal protection fuse	—	—
External protection on AC line	MCB: C-10 A / Fuse: T-10 A	MCB: C-10 A / Fuse: T-10 A
OUTPUT TECHNICAL DATA		
Output rated voltage	72 Vdc ±1%	100-110-170 Vdc ±1%
Output adjustable range	50...87 Vdc	88...175 Vdc
Continuous current	33 A at 45°C	14 A at 45°C
Overload limiting	50 A for >5 s	21 A for >5 s
Short circuit peak current	50 A for 5 s	21 A for 5 s
Ripple @ nominal ratings	200 mVpp	200 mVpp
Hold up time	10 ms (400 Vac) / 10 ms (500 Vac)	10 ms (400 Vac) / 10 ms (500 Vac)
Status indication	LED "DC OK" / LED "Alarm" / Display	LED "DC OK" / LED "Alarm" / Display
Alarm contact	dry contact, max. 1A @ 24 Vdc (programmable)	dry contact, max. 1A @ 24 Vdc (programmable)
Parallel connection	possible	possible
Redundant parallel connection	already fitted with internal ORing diode	already fitted with internal ORing diode
GENERAL TECHNICAL DATA		
Efficiency	92% (400 Vac) / 92% (500 Vac)	92% (400 Vac) / 92% (500 Vac)
Dissipated power	200 W (400 Vac) / 200 W (500 Vac)	200 W (400 Vac) / 200 W (500 Vac)
Operating temperature range	-20...+60°C (derating -40 W >45°C)	-20...+60°C (derating -40 W >45°C)
Input / output isolation	3 kVac / 60 s (no SELV output)	3 kVac / 60 s (no SELV output)
Input / ground isolation	1.5 kVac / 60 s	1.5 kVac / 60 s
Output / ground isolation	0.5 kVac / 60 s	0.5 kVac / 60 s
Standard / approvals	EN 60950-1	EN 60950-1
EMC Standards	EN 61000-6-2, EN 61000-6-4	EN 61000-6-2, EN 61000-6-4
Overvoltage category / Pollution degree	II / 2	II / 2
Protection degree	IP 20	IP 20
Connection terminal IN/OUT	4 mm ² / 35 mm ²	4 mm ² / 35 mm ²
Housing material	aluminium	aluminium
Dimension	234x105x130 mm	234x105x130 mm
Approximate weight	2.8 Kg	2.8 Kg
Mounting information	vertical on a rail, 60 mm from adjacent components	vertical on a rail, 60 mm from adjacent components
APPROVALS		
ACCESSORIES		
Mounting rail (IEC60715/TH35-7.5)	PR/3/AC, PR/3/AC/ZB, PR/3/AS, PR/3/AS/ZB	PR/3/AC, PR/3/AC/ZB, PR/3/AS, PR/3/AS/ZB
Mounting rail (IEC60715/TH35-15)	PR/3/PP, PR/3/PP/ZB, PR/3/PA, PR/3/PA/ZB	PR/3/PP, PR/3/PP/ZB, PR/3/PA, PR/3/PA/ZB
Marking tag	TAP207A, TAP128A, TAP178A, TAP209A	TAP207A, TAP128A, TAP178A, TAP209A

- DC wide range input
- Short circuit, overload, input and output overvoltage protections
- Over temperature protection
- Compact dimension



NOTE

Please refer to the datasheet for more details

Above overcurrent limit, the protection starts cycling in ON/OFF mode(hiccup autoreset), the maximum current supplied depends by the line resistance

Inrush current measured at Un with battery power supply; peak current varies according to the internal impedance of the current source and the resistance of the connections.

The capacitors between phase and neutral, requires that the isolation tests are carried out in DC

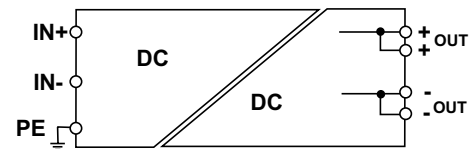
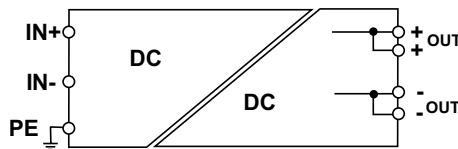

CODE	XCSA120BC	XCSA120CB
TYPE	CSA120BC	CSA120CB
INPUT TECHNICAL DATA		
Input rated voltage	12 Vdc	24 Vdc
Input voltage AC	—	—
Input voltage DC	10.5...18 Vdc	18...36 Vdc
Frequency	—	—
Current consumption	10 A (12 Vdc) ±10%	5.1 A (24 Vdc) ±10%
Inrush peak current	60 A	110 A
Power factor	—	—
Internal protection fuse	T 20 A	T 10 A
External protection on AC line	MCB: C-25 A / Fuse: T-25 A	MCB: C-13 A / Fuse: T-13 A
OUTPUT TECHNICAL DATA		
Output rated voltage	24 Vdc	12...15 Vdc
Output adjustable range	22.5...27.5 Vdc	12...15 Vdc
Continuous current	5 A (24 Vdc)	7 A (12 Vdc)
Overload limiting	6.5 A	9.1 A
Short circuit peak current	12 A for 300 ms	15 A for 300 ms
Ripple @ nominal ratings	100 mVpp	100 mVpp
Hold up time	1 ms	2 ms
Status indication	LED "DC OK"	LED "DC OK"
Alarm contact	—	—
Parallel connection	possible	possible
Redundant parallel connection	possible with external ORing diode	possible with external ORing diode
GENERAL TECHNICAL DATA		
Efficiency	83% (12 Vdc)	85% (24 Vdc)
Dissipated power	25 W (12 Vdc)	17 W (24 Vdc)
Operating temperature range	-20...+50°C	-20...+50°C
Input / output isolation	2.1 kVdc / 60s	2.1 kVdc / 60s
Input / ground isolation	1.41 kVdc / 60s	1.41 kVdc / 60s
Output / ground isolation	0.75 kVdc / 60s	0.75 kVdc / 60s
Standard / approvals	EN 60950-1	EN 60950-1
EMC Standards	EN 61000-6-1, EN 61000-6-2, EN 61000-6-3, EN 61000-6-4	EN 61000-6-1, EN 61000-6-2, EN 61000-6-3, EN 61000-6-4
Overvoltage category / Pollution degree	II / 2	II / 2
Protection degree	IP 20	IP 20
Connection terminal IN/OUT	2.5 mm ² / 2.5 mm ²	2.5 mm ² / 2.5 mm ²
Housing material	aluminium	aluminium
Dimension	40x130x115 mm	40x130x115 mm
Approximate weight	550 g	550 g
Mounting information	vertical on a rail, 10 mm from adjacent components	vertical on a rail, 10 mm from adjacent components
APPROVALS	CE	CE
ACCESSORIES		
Mounting rail (IEC60715/TH35-7.5)	PR/3/AC, PR/3/AC/ZB, PR/3/AS, PR/3/AS/ZB	PR/3/AC, PR/3/AC/ZB, PR/3/AS, PR/3/AS/ZB
Mounting rail (IEC60715/TH35-15)	PR/3/PP, PR/3/PP/ZB, PR/3/PA, PR/3/PA/ZB	PR/3/PP, PR/3/PP/ZB, PR/3/PA, PR/3/PA/ZB
Marking tag	—	—

- DC wide range input
- Short circuit, overload, input and output overvoltage protections
- Over temperature protection
- Compact dimension



NOTE

Please refer to the datasheet for more details

Above overcurrent limit, the protection starts cycling in ON/OFF mode(hiccup autoreset), the maximum current supplied depends by the line resistance

Inrush current measured at Un with battery power supply; peak current varies according to the internal impedance of the current source and the resistance of the connections.

The capacitors between phase and neutral, requires that the isolation tests are carried out in DC

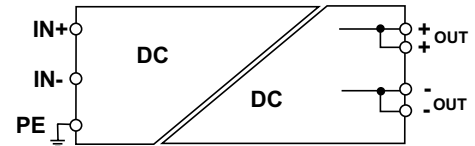
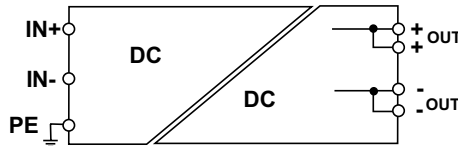

CODE	XCSA120CC	XCSA120DC
TYPE	CSA120CC	CSA120DC
INPUT TECHNICAL DATA		
Input rated voltage	24 Vdc	48 Vdc
Input voltage AC	—	—
Input voltage DC	18...36 Vdc	36...72 Vdc
Frequency	—	—
Current consumption	5.8 A (24 Vdc) ±10%	2.8 A (48 Vdc) ±10%
Inrush peak current	90 A	120 A
Power factor	—	—
Internal protection fuse	T 10 A	T 5 A
External protection on AC line	MCB: C-13 A / Fuse: T-13 A	MCB: C-6 A / Fuse: T-6 A
OUTPUT TECHNICAL DATA		
Output rated voltage	24 Vdc	24 Vdc
Output adjustable range	22.5...27.5 Vdc	22.5...27.5 Vdc
Continuous current	5 A (24 Vdc)	5A (24 Vdc)
Overload limiting	6.5 A	6.5 A
Short circuit peak current	12 A for 300 ms	13 A for 300 ms
Ripple @ nominal ratings	150 mVpp	200 mVpp
Hold up time	2 ms	4.5 ms
Status indication	LED "DC OK"	LED "DC OK"
Alarm contact	—	—
Parallel connection	possible	possible
Redundant parallel connection	possible with external ORing diode	possible with external ORing diode
GENERAL TECHNICAL DATA		
Efficiency	87% (24 Vdc)	90% (48 Vdc)
Dissipated power	18 W (24 Vdc)	13 W (48 Vdc)
Operating temperature range	-20...+50°C	-20...+50°C
Input / output isolation	2.1 kVdc / 60s	2.1 kVdc / 60s
Input / ground isolation	1.41 kVdc / 60s	1.41 kVdc / 60s
Output / ground isolation	0.75 kVdc / 60s	0.75 kVdc / 60s
Standard / approvals	EN 60950-1	EN 60950-1
EMC Standards	EN 61000-6-1, EN 61000-6-2, EN 61000-6-3, EN 61000-6-4	EN 61000-6-1, EN 61000-6-2, EN 61000-6-3, EN 61000-6-4
Overvoltage category / Pollution degree	II / 2	II / 2
Protection degree	IP 20	IP 20
Connection terminal IN/OUT	2.5 mm ² / 2.5 mm ²	2.5 mm ² / 2.5 mm ²
Housing material	aluminium	aluminium
Dimension	40x130x115 mm	40x130x115 mm
Approximate weight	550 g	550 g
Mounting information	vertical on a rail, 10 mm from adjacent components	vertical on a rail, 10 mm from adjacent components
APPROVALS	CE	CE
ACCESSORIES		
Mounting rail (IEC60715/TH35-7.5)	PR/3/AC, PR/3/AC/ZB, PR/3/AS, PR/3/AS/ZB	PR/3/AC, PR/3/AC/ZB, PR/3/AS, PR/3/AS/ZB
Mounting rail (IEC60715/TH35-15)	PR/3/PP, PR/3/PP/ZB, PR/3/PA, PR/3/PA/ZB	PR/3/PP, PR/3/PP/ZB, PR/3/PA, PR/3/PA/ZB
Marking tag	—	—

- DC wide range input
- Short circuit, overload, input and output overvoltage protections
- Over temperature protection
- Compact dimension
- Internal diode for the redundant parallel connection



NOTE

Please refer to the datasheet for more details

Above overcurrent limit, the protection starts cycling in ON/OFF mode(hiccup autoreset), the maximum current supplied depends by the line resistance

Inrush current measured at U_n with battery power supply; peak current varies according to the internal impedance of the current source and the resistance of the connections.

The capacitors between phase and neutral, requires that the isolation tests are carried out in DC

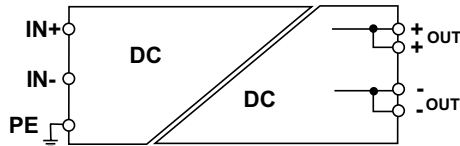

CODE	XCSA240FC
TYPE	CSA240FC
INPUT TECHNICAL DATA	
Input rated voltage	110 Vdc
Input voltage AC	—
Input voltage DC	100...130 Vdc
Frequency	—
Current consumption	2.4 A (110 Vdc) ±10%
Inrush peak current	150 A
Power factor	—
Internal protection fuse	T 5 A
External protection on AC line	MCB: C-6 A / Fuse: T-6 A
OUTPUT TECHNICAL DATA	
Output rated voltage	24 Vdc
Output adjustable range	23...27 Vdc
Continuous current	10 A at 50°C
Overload limiting	15 A
Short circuit peak current	21 A for 300 ms
Ripple @ nominal ratings	100 mVpp
Hold up time	4 ms
Status indication	LED "DC OK"
Alarm contact	—
Parallel connection	possible
Redundant parallel connection	already fitted with internal Oring diode
GENERAL TECHNICAL DATA	
Efficiency	89% (110 Vdc)
Dissipated power	28W (110 Vdc)
Operating temperature range	-20...+60°C (derating -6 W >50°C)
Input / output isolation	2.1 kVdc / 60s
Input / ground isolation	1.41 kVdc / 60s
Output / ground isolation	0.75 kVdc / 60s
Standard / approvals	EN 60950-1
EMC Standards	EN 61000-6-2, EN 61000-6-4
Overvoltage category / Pollution degree	II / 2
Protection degree	IP 20
Connection terminal IN/OUT	2.5 mm ² / 2.5 mm ²
Housing material	aluminium
Dimension	40x130x115 mm
Approximate weight	800 g
Mounting information	vertical on a rail, 10 mm from adjacent components
APPROVALS	CE
ACCESSORIES	
Mounting rail (IEC60715/TH35-7.5)	PR/3/AC, PR/3/AC/ZB, PR/3/AS, PR/3/AS/ZB
Mounting rail (IEC60715/TH35-15)	PR/3/PP, PR/3/PP/ZB, PR/3/PA, PR/3/PA/ZB
Marking tag	—

- Powered by a 12-24 Vac secondary transformer
- Short circuit, overload and input overvoltage protection
- Over temperature protection
- Adjustable output voltage



NOTE
Please refer to the datasheet for more details

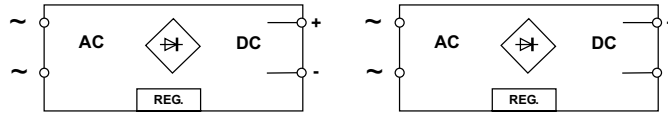

APPLICATIONS

Cabur CL-R series power supplies are linear stabilised with adjustable output, capable of satisfying all small load power needs with non-standard voltages at an extremely affordable cost.

They can be rail mounted in any position as long as sufficient space is left for the free circulation of air for cooling, while model CL1R has a degree of protection IP00, meaning it is to be used inside a protected container.

Even where the power supply is protected against overcurrents, it is advised to follow the nominal data indicated in the tables below.

(1) **CL1R** and **CL5R** provide the nominal performances if combined with the secondary voltages indicated in **Tab. 1**; with a secondary voltage of 24...27 Vac, the maximum obtainable current at output voltages adjusted to values below 24 Vdc is indicated in **Tab. 2**; to stabilise the output voltage and reduce ripple at full load, linear power supplies must be powered with an input voltage that exceeds the output voltage, whereas if they are powered at 24 Vac, with an output adjusted to 24 Vdc and maximum current absorption, the ripple increases and the stability of the output voltage to load variations and $\pm 10\%$ network variations drops; voltages above 27 Vac cause significant heating, triggering the thermal protection and reducing the current supplied.

Products are supplied with a default voltage of 24 Vdc at the output and 26 Vac at the input.

CODE	XCL1R	XCL5R
TYPE	CL1R	CL5R
INPUT TECHNICAL DATA		
Input rated voltage	12-24 Vac	12-24 Vac
Input voltage AC	10...26 Vac (see Table 1)	10...26 Vac (see Table 1)
Input voltage DC	—	—
Frequency	47...63 Hz	47...63 Hz
Current consumption	2.5 A (24 Vac)	6 A (24 Vac)
Inrush peak current	—	—
Power factor	—	—
Internal protection fuse	T 3 A	T 10 A
External protection on AC line	MCB: C-4 A / Fuse: T-4 A	MCB: C-10 A / Fuse: T-10 A
OUTPUT TECHNICAL DATA		
Output rated voltage	1.2...24 Vdc	1.2...24 Vdc
Output adjustable range	(see Table 1 and Table 2)	(see Table 1 and Table 2)
Continuous current	0.3...1.5 A (see Table 2)	0.8...5 A (see Table 2)
Overload limiting	—	—
Short circuit peak current	—	—
Ripple @ nominal ratings	< 50 mVpp at 24 Vac	< 50 mVpp at 24 Vac
Hold up time	>20 ms	>20 ms
Status indication	Green LED "DC OK"	Green LED "DC OK"
Alarm contact	—	—
Parallel connection	—	—
Redundant parallel connection	—	—
GENERAL TECHNICAL DATA		
Efficiency	—	—
Dissipated power	—	—
Operating temperature range	-20...+45°C	-20...+45°C
Input / output isolation	not insulated	not insulated
Input / ground isolation	0.5 kVac / 60 s	0.5 kVac / 60 s
Output / ground isolation	0.5 kVac / 60 s	0.5 kVac / 60 s
Standard / approvals	—	—
EMC Standards	—	—
Overvoltage category / Pollution degree	II / 2	II / 2
Protection degree	IP 00	IP 00
Connection terminal IN/OUT	2.5 mm ² / 2.5 mm ²	2.5 mm ² / 2.5 mm ²
Housing material	UL94V-0 plastic material	aluminium
Dimension	43x74x130	37x115x118
Approximate weight	120 g	350 g
Mounting information	vertical on a rail, 20 mm from adjacent components	vertical on a rail, 20 mm from adjacent components
APPROVALS	CE	CE
ACCESSORIES		
Mounting rail (IEC60715/TH35-7.5)	PR/3/AC, PR/3/AC/ZB, PR/3/AS, PR/3/AS/ZB	PR/3/AC, PR/3/AC/ZB, PR/3/AS, PR/3/AS/ZB
Mounting rail (IEC60715/TH35-15)	—	—
Marking tag	—	—

INPUT (Vac)	Uout max (Vdc)	Iout max (A) XCL1R	Iout max (A) XCL5R
24...27	24	1.5	5
16...18	15	1.5	5
14...16	12	1.5	5
12...14	10	1.5	5
12	9	1.5	5
9	5	1.5	5

Table 1 (see explanation to the side)

INPUT (Vac)	Uout max (Vdc)	Iout max (A) XCL1R	Iout max (A) XCL5R
24	24	1.5	5
24	15	0.8	2.5
24	12	0.7	2
24	10	0.5	1.5
24	9	0.45	1.3
24	5	0.3	0.8

Table 2 (see side explanation)

- Powered by a 12-24 Vac secondary transformer
- Rail mountable



NOTE

Please refer to the datasheet for more details
Output not protected against overcurrent and short circuit, an external fuse must be installed.

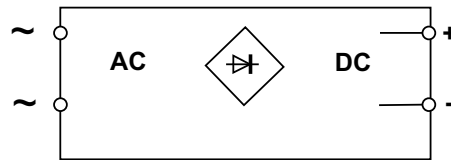

APPLICATIONS

The rectified and filtered power supply comprises a transformer which isolates and reduces the secondary voltage from the network voltage (not supplied), a bridge rectifier and a filter capacity that convert alternating voltage into direct voltage at an SELV value of less than 60 Vdc.

The power supply is not stabilised, therefore the output voltage varies according to the power consumed by the load and to network voltage fluctuations of $\pm 10\%$. The formulae described in the output technical data are used to calculate voltage at no load, 50% load and full load and to select the transformer best suited to your needs. **These power supplies are a reliable and affordable source for powering relays, contactors, solenoid valves and loads capable of operating smoothly with a relatively high (5%) alternating waste on 24 Vdc (ripple) and strong changes in output voltage, whereas in applications in which the network is highly unstable and prone to voltage dips, they may not be suitable for powering devices with microprocessors and memories, analogue converters or devices that require a highly stable power supply voltage.**

CODE	XAR6
TYPE	AR6
INPUT TECHNICAL DATA	
Input rated voltage	12-24 Vac
Input voltage AC	6...20 Vac
Input voltage DC	—
Frequency	47...63 Hz
Current consumption	7.2 A (24 Vac)
Inrush peak current	—
Power factor	—
Internal protection fuse	T 8 A
External protection on AC line	MCB: C-10 A / Fuse: T-10 A
OUTPUT TECHNICAL DATA	
Output rated voltage	$U_{out} = (U_{in} \times 1.41) - 2 \text{ V}$ (full load, see Tab. 1)
Output adjustable range	—
Continuous current	6 A at 20°C
Overload limiting	External fuse must be installed
Short circuit peak current	—
Ripple @ nominal ratings	2.5 Vpp
Hold up time	>20 ms
Status indication	Green LED "DC OK"
Alarm contact	—
Parallel connection	—
Redundant parallel connection	—
GENERAL TECHNICAL DATA	
Efficiency	—
Dissipated power	—
Operating temperature range	-20...+45°C
Input / output isolation	not insulated
Input / ground isolation	0.5 kVac / 60 s
Output / ground isolation	0.5 kVac / 60 s
Standard / approvals	—
EMC Standards	—
Overvoltage category / Pollution degree	II / 2
Protection degree	—
Connection terminal IN/OUT	2.5 mm ² / 2.5 mm ²
Housing material	UL94V-0 plastic material
Dimension	70x80x93
Approximate weight	140 g
Mounting information	vertical on a rail, 20 mm from adjacent components
APPROVALS	
ACCESSORIES	
Mounting rail (IEC60715/TH35-7.5)	PR/3/AC, PR/3/AC/ZB, PR/3/AS, PR/3/AS/ZB
Mounting rail (IEC60715/TH35-15)	—
Marking tag	—

Tab. 1 Input/Output behaviour

INPUT (Vac)	OUTPUT without load (Vdc)	OUTPUT full load (Vdc)
20	28.7	24.2
18	25.4	21.4
15	21.2	17.2
12	17	15
9	12.7	8.7
6	8.5	4.5

- Connected to a DC line, allow to supply loads and charge the backup battery
- Suitable for Lead-Acid batteries
- Suitable for power supplies with adjustable output



NOTE

Please refer to the datasheet or operating instruction for more details

In order to complete the charge, the DC output of the power supply must be 2-3V more than nominal voltage of the battery

XCSBC does not prevent deep discharge of the battery

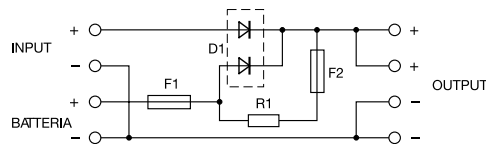

APPLICATIONS

1. Battery charger

This module enables Cabur power supplies to charge a battery while simultaneously powering the load.

The diodes effectively block the power supply from the battery, the resistor limits the load current to prevent power supply safety cut-off and prolonging the life of the battery, and fuse F1 protects the battery in the event of a short-circuit on the load.

The connection occurs as shown below.

2. Placing power supplies in parallel

This module can be used to put two power supplies without a blocking diode in parallel, eliminating the need for fuse F2 in series with the charging current limiting resistor.

The connection occurs as shown below.

CODE	XCSBC
TYPE	XCSBC
INPUT TECHNICAL DATA	
Input rated voltage	12-24 Vdc
Input voltage AC	—
Input voltage DC	6...30 Vdc
Frequency	—
Current consumption	> 3 A
Inrush peak current	—
Power factor	—
Internal protection fuse	—
External protection on AC line	—
OUTPUT TECHNICAL DATA	
Output rated voltage	12-24 Vdc ±1%
Output voltage range	V _{in} -0.2 normal operation / V _{batt} -0.2 battery operation (max. 29 Vdc)
Continuous current	10 A at 45°C
Battery safety fuse	Fuse: 6.3 A replaceable
Status indication	—
Alarm contact	—
Battery type	Lead-Acid
Battery capacity	max. 4 Ah (12 Vdc) / max. 10 Ah (24 Vdc)
Charging current	0.5 A (12 Vdc) / 1 A (24 Vdc)
Battery disconnection voltage	function not present
Protections	short-circuit / battery overload
GENERAL TECHNICAL DATA	
Efficiency	88%
Dissipated power	7.5 W (12 Vdc) 15 W (24 Vdc)
Operating temperature range	-20...+50°C
Input / output isolation	—
Input / ground isolation	—
Output / ground isolation	—
Standard / approvals	—
EMC Standards	—
Overvoltage category / Pollution degree	II / 2
Protection degree	IP 00
Connection terminal IN/OUT	2.5 mm ² / 2.5 mm128
Housing material	UL94V-0 plastic
Dimension	26x80x93 mm
Approximate weight	80 g
Mounting information	vertical on a rail, 10 mm from adjacent components
APPROVALS	
ACCESSORIES	
Mounting rail (IEC60715/TH35-7.5)	PR/3/AC, PR/3/AC/ZB, PR/3/AS, PR/3/AS/ZB
Mounting rail (IEC60715/TH35-15)	PR/3/PP, PR/3/PP/ZB, PR/3/PA, PR/3/PA/ZB
Marking tag	

1. Battery charger

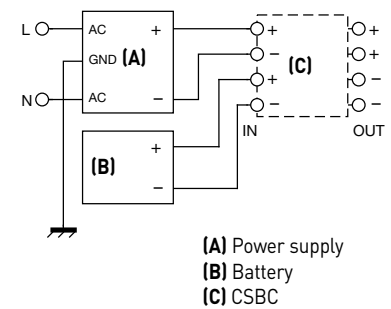

2. Placing power supplies in parallel

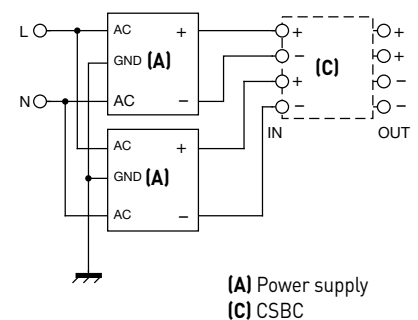

- Connected to a DC line, allow to supply loads and charge the backup battery
- Suitable for Lead-Acid batteries
- Suitable for power supplies with adjustable output
- Battery protection (overload and deep discharge)
- LED status indicator and alarm contact



NOTE

Please refer to the datasheet or operating instruction for more details
In order to complete the charge, the DC output of the power supply must be 2-3V more than nominal voltage of the battery

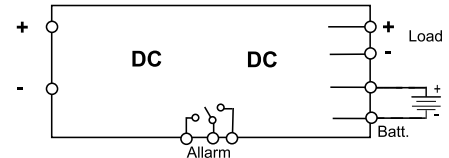
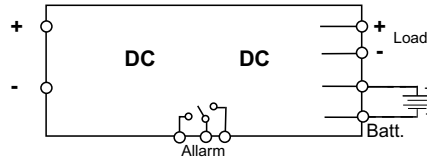

CODE	XCSUPS1	XCSUPS2
TYPE	CS-UPS1	CS-UPS2
INPUT TECHNICAL DATA		
Input rated voltage	12 Vdc	24 Vdc
Input voltage AC	—	—
Input voltage DC	26...28.5 Vdc	14...15 Vdc
Frequency	—	—
Current consumption	<14 A (full load and discharged battery)	<14 A (full load and discharged battery)
Inrush peak current	—	—
Power factor	—	—
Internal protection fuse	—	—
External protection on AC line	—	—
OUTPUT TECHNICAL DATA		
Output rated voltage	24 Vdc ±1%	12 Vdc ±1%
Output voltage range	26...28 Vdc normal operation, 17...26 Vdc battery operation	13...15 Vdc normal operation, 9...15 Vdc battery operation
Continuous current	10 A at 50°C	10 A at 50°C
Battery safety fuse	Fuse: 15 A replaceable	Fuse: 15 A replaceable
Status indication	LED "DC OK" / LED "Battery OK" / LED "Battery low" / LED "Load OK"	LED "DC OK" / LED "Battery OK" / LED "Battery low" / LED "Load OK"
Alarm contact	dry contact, max. 1A @ 24 Vdc (Uin >21.6 Vdc)	dry contact, max. 1A @ 24 Vdc (Uin >21.6 Vdc)
Battery type	Lead-Acid	Lead-Acid
Battery capacity	max. 40 Ah (24 Vdc)	max. 20 Ah (12 Vdc)
Charging current	2 A - 4 A selectable	2 A - 4 A selectable
Battery disconnection voltage	≤ 18 Vdc ±0.5V	≤ 9 Vdc ±0.5V
Protections	reverse polarity, short-circuit, battery overload, battery deep discharge	reverse polarity, short-circuit, battery overload, battery deep discharge
GENERAL TECHNICAL DATA		
Efficiency	-	-
Dissipated power	-	-
Operating temperature range	-20...+50°C	-20...+50°C
Input / output isolation	—	—
Input / ground isolation	—	—
Output / ground isolation	—	—
Standard / approvals	—	—
EMC Standards	—	—
Overvoltage category / Pollution degree	II / 2	II / 2
Protection degree	IP 20	IP 20
Connection terminal IN/OUT	2.5 mm ² / 2.5 mm ²	2.5 mm ² / 2.5 mm ²
Housing material	aluminium	aluminium
Dimension	55x130x115 mm	55x130x115 mm
Approximate weight	300 g	300 g
Mounting information	vertical on a rail, 10 mm from adjacent components	vertical on a rail, 10 mm from adjacent components
APPROVALS	CE	CE
ACCESSORIES		
Mounting rail (IEC60715/TH35-7.5)	PR/3/AC, PR/3/AC/ZB, PR/3/AS, PR/3/AS/ZB	PR/3/AC, PR/3/AC/ZB, PR/3/AS, PR/3/AS/ZB
Mounting rail (IEC60715/TH35-15)	—	—
Marking tag		

- Connected to a DC line, allow to supply loads and charge the backup battery
- Suitable for Lead-Acid, NiMH and Ni-Cd batteries
- Suitable for 12 and 24 Vdc loads and batteries
- Battery protection (overload and deep discharge)
- LED status indicator and alarm contact
- ModBus RTU communication port for setting and monitoring

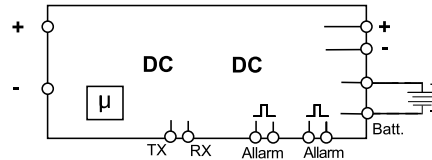

NOTE
Please refer to the datasheet or operating instruction for more details
Internal DC/DC converter avoid to increase the output voltage of the 24V net

APPLICATIONS

XCSU120S is a smart battery charger equipped with a microprocessor to determine the most appropriate charging and monitoring algorithm to ensure battery efficiency. Using an external DC power source, XCSU120S is able to charge universal and NiCd, NiMH and lead acid batteries.

PRODUCT FEATURES:

- Independent 12 or 24 V input, output and battery voltages (microprocessor sets the voltage to the required level)
- It is no longer necessary to increase the voltage of the power supply to allow the battery to charge, resulting in an increase of the output voltage
- The device is supplied with a default setting that can be changed with a simple ModBus connection, which can also be used to monitor functions and establish a direct connection to a PLC
- Integrated software allows you to select battery type and capacity, with the microprocessor selecting the most appropriate charging algorithm and monitoring its efficiency
- System monitoring with two available remote alarms that can be set to no network power, battery on, battery efficiency, battery overtemperature, output overload
- Programmable remote control for turning battery charging, output and alarms on/off
- Programmable on/off timer
- DIP-switch programming for most functions

CODE	XCSU120S
TYPE	CSU120S
INPUT TECHNICAL DATA	
Input rated voltage	12-24 Vdc
Input voltage AC	—
Input voltage DC	10...16 Vdc / 20...29 Vdc
Frequency	—
Current consumption	5 A
Inrush peak current	—
Power factor	—
Internal protection fuse	—
External protection on AC line	—
OUTPUT TECHNICAL DATA	
Output rated voltage	12-24 Vdc ±1%
Output voltage range	12-24 Vdc normal and battery operation
Continuous current	5 A at 20°C / 4 A at 45°C
Battery safety fuse	Fuse: 5 A autorestart
Status indication	LED "DC OK" / LED "Battery" / LED "Alarm"
Alarm contact	2 digital signal
Battery type	Lead-Acid, NiMH, Ni-Cd
Battery capacity	max. 4 Ah (12 Vdc) / max. 4 Ah (24 Vdc)
Charging current	500 mA programmable
Battery disconnection voltage	≤ 9 Vdc (12 Vdc) / 18 Vdc (24 Vdc) ±0.5V
Protections	reverse polarity/overload/deep discharge
GENERAL TECHNICAL DATA	
Efficiency	90%
Dissipated power	2 W (12 Vdc) 2 W (24 Vdc)
Operating temperature range	-20...+60°C (derating -2 W >50°C)
Input / output isolation	—
Input / ground isolation	—
Output / ground isolation	—
Standard / approvals	—
EMC Standards	EN 61000-6-1, EN 61000-6-2, EN 61000-6-3, EN 61000-6-4
Overvoltage category / Pollution degree	II / 2
Protection degree	IP 20
Connection terminal IN/OUT	2.5 mm ² / 2.5 mm ²
Housing material	aluminium
Dimension	70x63x88 mm
Approximate weight	200 g
Mounting information	vertical on a rail, 10 mm from adjacent components
APPROVALS	CE
ACCESSORIES	
Mounting rail (IEC60715/TH35-7.5)	PR/3/AC, PR/3/AC/ZB, PR/3/AS, PR/3/AS/ZB
Mounting rail (IEC60715/TH35-15)	PR/3/PP, PR/3/PP/ZB, PR/3/PA, PR/3/PA/ZB
Marking tag	

- Connected to a DC line, allow to supply loads and charge the backup battery
- Suitable for Lead-Acid, NiMH and Ni-Cd batteries
- Suitable for 12 and 24 Vdc loads and batteries
- Battery protection (overload and deep discharge)
- LED status indicator and alarm contact
- ModBus RTU communication port for setting and monitoring



NOTE
Please refer to the datasheet or operating instruction for more details
Internal DC/DC converter avoid to increase the output voltage of the 24V net

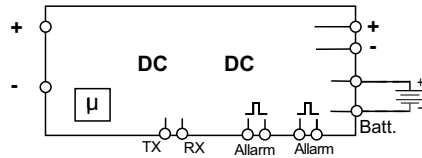

APPLICATIONS

XCSU240S is a smart battery charger equipped with a microprocessor to determine the most appropriate charging and monitoring algorithm to ensure battery efficiency. Using an external DC power source, XCSU240S is able to charge NiCd, NiMH and lead acid batteries.

PRODUCT FEATURES:

- Independent 12 or 24 V input, output and battery voltages (microprocessor sets the voltage to the required level)
- It is no longer necessary to increase the voltage of the power supply to allow the battery to charge, resulting in an increase of the output voltage
- The device is supplied with a default setting that can be changed with a simple ModBus connection, which can also be used to monitor functions and establish a direct connection to a PLC
- Integrated software allows you to select battery type and capacity, with the microprocessor selecting the most appropriate charging algorithm and monitoring its efficiency
- System monitoring with two available remote alarms that can be set to no network power, battery on, battery efficiency, battery overtemperature, output overload
- Programmable remote control for turning battery charging, output and alarms on/off
- Programmable on/off timer

CODE	XCSU240S
TYPE	CSU240S
INPUT TECHNICAL DATA	
Input rated voltage	12-24 Vdc
Input voltage AC	—
Input voltage DC	11... 30 Vdc
Frequency	—
Current consumption	10 A
Inrush peak current	—
Power factor	—
Internal protection fuse	—
External protection on AC line	—
OUTPUT TECHNICAL DATA	
Output rated voltage	12-24 Vdc ±1%
Output voltage range	Vin-0.2 normal operation / Vbatt-0.2 battery operation (max. 29 Vdc)
Continuous current	10 A at 20°C / 9A at 40°C
Battery safety fuse	Fuse: 10 A autorestart
Status indication	LED "DC OK" / LED "Battery" / LED "Alarm"
Alarm contact	2 digital signal
Battery type	Lead-Acid, NiMH, Ni-Cd
Battery capacity	max. 10 Ah (12 Vdc) / max. 10 Ah (24 Vdc)
Charging current	900 mA programmable
Battery disconnection voltage	≤ 9 Vdc (12 Vdc) / 18 Vdc (24 Vdc) ±0.5V
Protections	reverse polarity/overload/deep discharge
GENERAL TECHNICAL DATA	
Efficiency	90%
Dissipated power	3 W (12 Vdc) 3 W (24 Vdc)
Operating temperature range	-20...+60°C (derating -2 W >50°C)
Input / output isolation	—
Input / ground isolation	—
Output / ground isolation	—
Standard / approvals	—
EMC Standards	EN 61000-6-1, EN 61000-6-2, EN 61000-6-3, EN 61000-6-4
Overvoltage category / Pollution degree	II / 2
Protection degree	IP 20
Connection terminal IN/OUT	2.5 mm ² / 2.5 mm ² / 0.75 mm ² (signals)
Housing material	aluminium
Dimension	40x130x115 mm
Approximate weight	300 g
Mounting information	vertical on a rail, 10 mm from adjacent components
APPROVALS	CE
ACCESSORIES	
Mounting rail (IEC60715/TH35-7.5)	PR/3/AC, PR/3/AC/ZB, PR/3/AS, PR/3/AS/ZB
Mounting rail (IEC60715/TH35-15)	PR/3/PP, PR/3/PP/ZB, PR/3/PA, PR/3/PA/ZB
Marking tag	

- Power supply with integrated battery charger
- Suitable for Lead-Acid batteries
- Supplies power to load and battery simultaneously
- Battery protection (overload and deep discharge)
- LED status indicator and alarm contact



NOTE

Please refer to the datasheet or operating instruction for more details

In order to complete the charge, the DC output of the power supply must be 2-3V more than nominal voltage of the battery

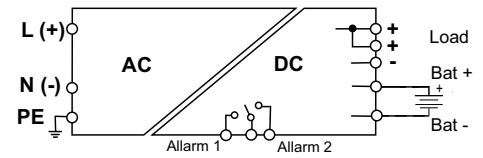
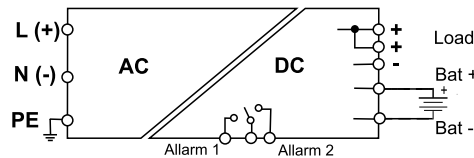

CODE	XSCSC120B	XSCSC120C
TYPE	CSC120B	CSC120C
INPUT TECHNICAL DATA		
Input rated voltage	120-230 Vac	120-230 Vac
Input voltage AC	90...264 Vac	90...264 Vac
Input voltage DC	100...345 Vdc [derating U _{in} <130 Vdc]	100...345 Vdc [derating U _{in} <130 Vdc]
Frequency	47...63 Hz	47...63 Hz
Current consumption	1.6 A (120 Vac) / 0.91 A (230 Vac)	1.9 A (120 Vac) / 1.1 A (230 Vac)
Inrush peak current	20 A	20 A
Power factor	> 0.65	> 0.65
Internal protection fuse	T 3.15 A	T 3.15 A
External protection on AC line	MCB: C-4 A / Fuse: T 4 A	MCB: C-4 A / Fuse: T 4 A
OUTPUT TECHNICAL DATA		
Output rated voltage	12 Vdc ±1%	24 Vdc ±1%
Output voltage range	13...15 Vdc normal operation, 9...15 Vdc battery operation	26...26 Vdc normal operation, 17...25 Vdc battery operation
Continuous current	5 A at 50°C	5 A at 50°C
Battery safety fuse	-	-
Status indication	LED "DC OK" / LED "Alarm"	LED "DC OK" / LED "Alarm"
Alarm contact	dry contact, max. 1A @ 24 Vdc (U _{in} > 21.6 Vdc)	dry contact, max. 1A @ 24 Vdc (U _{in} > 10.8 Vdc)
Battery type	Lead-Acid	Lead-Acid
Battery capacity	max. 1.2 Ah (12 Vdc)	max. 1.2 Ah (24 Vdc)
Charging current	150 mA	150 mA
Battery disconnection voltage	≤ 9 Vdc ±0.5V	≤ 18 Vdc ±0.5V
Protections	short-circuit / battery overload	reverse polarity, short-circuit, battery overload, battery deep discharge
GENERAL TECHNICAL DATA		
Efficiency	81% (120 Vac) 83% (230 Vac)	84% (120 Vac) 86% (230 Vac)
Dissipated power	25 W (120 Vac) 22 W (230 Vac)	22 W (120 Vac) 19 W (230 Vac)
Operating temperature range	-20...+60°C (derating -2 W >45°C)	-20...+60°C (derating -3.2 W >45°C)
Input / output isolation	3 kVac / 60 s (SELV output)	3 kVac / 60 s (SELV output)
Input / ground isolation	1.5 kVac / 60 s	1.5 kVac / 60 s
Output / ground isolation	0.5 kVac / 60 s	0.5 kVac / 60 s
Standard / approvals	EN 60950-1	EN 60950-1
EMC Standards	EN 61000-6-1, EN 61000-6-2, EN 61000-6-3, EN 61000-6-4	EN 61000-6-1, EN 61000-6-2, EN 61000-6-3, EN 61000-6-4
Overvoltage category / Pollution degree	II / 2	II / 2
Protection degree	IP 20	IP 20
Connection terminal IN/OUT	2.5 mm ² / 2.5 mm ²	2.5 mm ² / 2.5 mm ²
Housing material	aluminium	aluminium
Dimension	40x130x115 mm	40x130x115 mm
Approximate weight	450 g	450 g
Mounting information	vertical on a rail, 10 mm from adjacent components	vertical on a rail, 10 mm from adjacent components
APPROVALS	CE	CE
ACCESSORIES		
Mounting rail (IEC60715/TH35-7.5)	PR/3/AC, PR/3/AC/ZB, PR/3/AS, PR/3/AS/ZB	PR/3/AC, PR/3/AC/ZB, PR/3/AS, PR/3/AS/ZB
Mounting rail (IEC60715/TH35-15)	PR/3/PP, PR/3/PP/ZB, PR/3/PA, PR/3/PA/ZB	PR/3/PP, PR/3/PP/ZB, PR/3/PA, PR/3/PA/ZB
Marking tag		

- Suitable for connecting power supplies without ORing diodes
- 12, 24 and 48 Vdc selectable operating voltages
- 2 alarm relays
- Compact dimensions

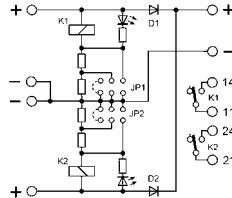

APPLICATIONS

This module is used for placing two power supplies without blocking diodes in parallel; jumpers can be used to select the desired operating voltage, and each channel has a relay and an LED diode giving you a remote alarm signal in case a power supply switches off.

Connection Diagram

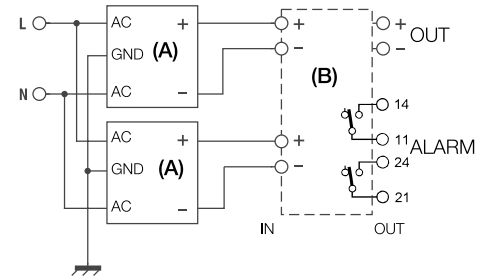

(A) Power supply
(B) CSBD

CODE	XCSBD
TYPE	CSBD
INPUT TECHNICAL DATA	
Input voltage range	12-24-48 Vdc
Input nominal current	2 x 15 A
Internal protection fuse	—
OUTPUT TECHNICAL DATA	
Output voltage range	12-24-48 Vdc selectable
Continuous current	1 x 15 A (max. 30 A peak)
Overload limiting	—
Protections	—
IN-OUT voltage drop	0.7 V at 15 A
Status indication	LED "DC OK"
Alarm contact	2 dry contact, max. 1A @ 24 Vdc
GENERAL TECHNICAL DATA	
Efficiency	—
Dissipated power	—
Operating temperature range	-20...+50°C
Input / output isolation	—
Input / ground isolation	—
Output / ground isolation	—
Standard approvals	—
EMC Standards	—
Overvoltage category / Pollution degree	II / 2
Protection degree	IP 00
Connection terminal IN / OUT	2.5 mm ² / 2.5 mm ²
Housing material	UL94V-0 plastic material
Dimensions	40x130x85
Approximate weight	120 g
Mounting information	vertical on a rail, 10 mm from adjacent components
APPROVALS	
ACCESSORIES	
Mounting rail (IEC60715/TH35-7.5)	PR/3/AC, PR/3/AC/ZB, PR/3/AS, PR/3/AS/ZB
Mounting rail (IEC60715/TH35-15)	PR/3/PP, PR/3/PP/ZB, PR/3/PA, PR/3/PA/ZB
Marking tag	—

- Suitable for connecting power supplies without ORing diodes
- Suitable for 12 to 80 V
- CPU-controlled electronic redundancy
- Current failure and unbalance alarm
- High efficiency and low consumption



PRELIMINARY



PRELIMINARY

NOTE

[1] The "DC-OK" LED signals the status of the output, "Unbalance" LEDs signal if the current sharing is balanced or not balanced, "alarm" LED signals an unbalanced and critical situation or the failure of one power supply
 [2] The "Alarm" contact opens in case of an unbalanced and critical situation or the failure of one power supply

CODE	XCSR2M20AA	XCSR2M40AA
TYPE	CSR-2M/20/AA	CSR-2M/40/AA
INPUT TECHNICAL DATA		
Input voltage range	12...80 Vdc	12...80 Vdc
Input nominal current	2 x 20 A	2 x 40 A
Internal protection fuse	—	—
OUTPUT TECHNICAL DATA		
Output voltage range	10.8...85 Vdc	10.8...85 Vdc
Continuous current	1 x 25 A (max. 40 A peak)	1 x 50 A (max. 80 A peak)
Overload limiting	—	—
Protections	—	—
IN-OUT voltage drop	0.2 V at 25 A	0.2 V at 50 A
Status indication	LED "DC OK" / LED "Alarm" / LED "Unbalance" (1)	LED "DC OK" / LED "Alarm" / LED "Unbalance" (1)
Alarm contact	dry contact, max. 1A @ 24 Vdc (2)	dry contact, max. 1A @ 24 Vdc (2)
GENERAL TECHNICAL DATA		
Efficiency	>98% (12 V / 50 A)	>98% (12 V / 50 A)
Dissipated power	5 W	10 W
Operating temperature range	-20...+50°C	-20...+50°C
Input / output isolation	—	—
Input / ground isolation	—	—
Output / ground isolation	—	—
Standard approvals	—	—
EMC Standards	EN 61000-6-2, EN 61000-6-4	EN 61000-6-2, EN 61000-6-4
Overvoltage category / Pollution degree	II / 2	II / 2
Protection degree	IP 20	IP 20
Connection terminal IN / OUT	16 mm ² / 16 mm ² / 1.5 mm ² (signal)	16 mm ² / 16 mm ² / 1.5 mm ² (signal)
Housing material	aluminium	aluminium
Dimensions	40x110x145	40x110x145
Approximate weight	200 g	200 g
Mounting information	vertical on a rail, 10 mm from adjacent components	vertical on a rail, 10 mm from adjacent components
APPROVALS	CE	CE
ACCESSORIES		
Mounting rail (IEC60715/TH35-7.5)	PR/3/AC, PR/3/AC/ZB, PR/3/AS, PR/3/AS/ZB	PR/3/AC, PR/3/AC/ZB, PR/3/AS, PR/3/AS/ZB
Mounting rail (IEC60715/TH35-15)	—	—
Marking tag	—	—

- Monitoring of signals from the CSL 480W series power supplies
- Remote power on and off of the power supply
- ModBus RTU communication

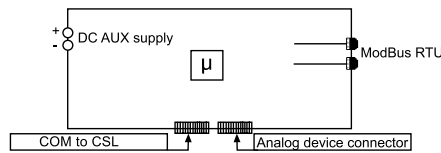

XCI001MB is a microprocessor-controlled communication interface that allow the connection to the net and the remote monitoring of the CSL1-480...AB/CSL3-480...AB power supply, by using the ModBus RTU protocol.

The communication Interface can be directly powered by the monitored PSU by the AUX2 port or can be powered by an auxiliary PSU (10 - 30 Vdc). This option allows the remote control of the PSU ON/OFF.

The connection to the ModBus net take place by 2 equivalent RJ-45 port and the address of the device can be set by using the dip switch on the front panel.

The XCI001MB also allow the connection of additional analog and digital signals, through the AUX1 port.

CODE	XCCI001MB
TYPE	CCI001MB
Power supply	10 - 30 Vdc
Communication protocol	ModBus RTU
Signalling	Green LED - Power on / Yellow LED - TX/RX activity on going
Operating temperature	-20 .. +50 °C
Protection degree	IP20
Standards	CE
Dimensions	40x130x115 mm
Weight	300 g
Housing material	Alluminium
Mounting	DIN rail

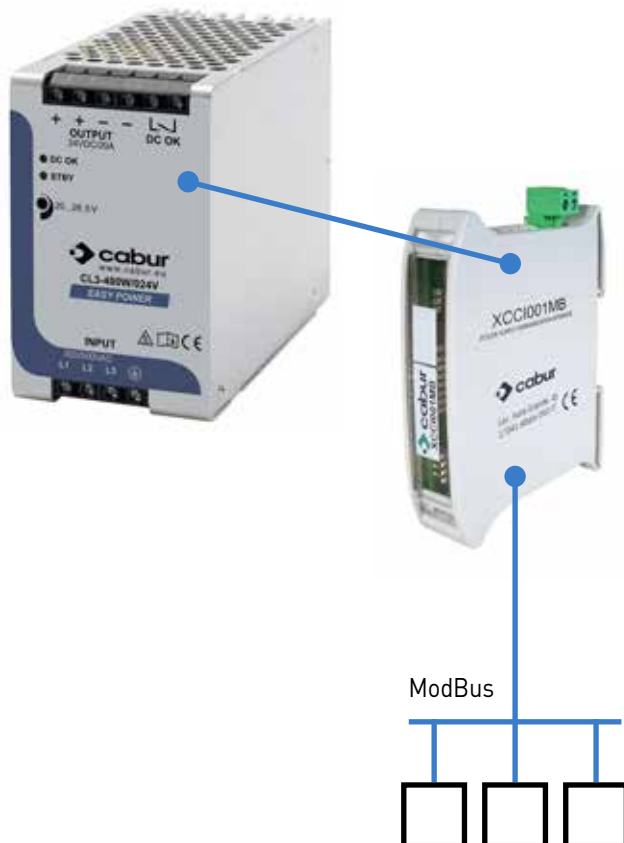

Blank lined area for notes.

Protections

MBC2K is a microprocessor-controlled device designed for braking DC bus-powered engines. It is activated by the surge generated by the engine when its drive requires braking.

When the MBC2K is connected on the DC bus powering the engine drive (see diagram in fig. 1), the device activates automatically when the DC bus voltage exceeds the set threshold and transfers the power generated by the engine to the braking resistor, where it is dissipated. MBC2K is equipped with protection against short circuit, overload and over temperature in order to guarantee reliable operation. MBC2K can be connected to any DC bus power supply with a voltage within 24 and 100 Vdc. The simplified application is illustrated in the block diagram in Figure 1, the front view of the unit with all controls and functions is shown in Figure 2. CONNECT up to 4 units in parallel to increase the peak braking power up to 8 KW. MBC2K also has a 7-segment display and an LED for instantly viewing the DC bus voltage (accuracy +/- 1 V) which helps the user during set-up and in displaying error messages.

MBC2K setup

The MBC2K unit must be set-up prior to operation.

The menu comprises three pages, navigable using the MENU button;

The values shown can be adjusted by pressing the SET/RESET button.

- a) brake intervention threshold (VTH)
- b) brake intervention threshold hysteresis
- c) Master/Slave mode; for selecting single mode (Master mode) or for parallel connection of up to 4 cards (1 Master+3 Slave).

Active protections

The MBC2K integrates active protections to ensure stable and reliable operation under normal use conditions. When it detects a fault, MBC2K turns itself off to prevent an uncontrolled flow of current through the braking resistor.

Fault status is indicated by the alarm LED flashing continuously.

And the integrated alarm relay allows the status of the module to be checked remotely.

To help the user understand which defect has occurred, an error code is shown on the 7-segment display.

Connect up to 4 MBC2K units in parallel

Up to 4 MBC2K units can be connected in parallel to increase peak braking capacity to 8 KW. Each unit is capable of braking 2 KW of peak power, for which each unit requires its own braking resistor. To set up this configuration, MBC2K is equipped with a bus that is used to synchronise the operation of all connected units (up to 4 max.). The principle of operation is based on one MBC2K unit configured as a Master and the other MBC2K units (up to 3) configured as Slaves.

The Master measures the DC bus voltage and decides when to insert the braking resistors into the circuit, sending a command on the synchronisation bus. When the Slave units connected to the synchronisation bus receive the command from the Master unit, they insert their braking resistor into the circuit. When MBC2K is configured in Slave mode, all of its protective circuits remain operational.



Figure 1 application block diagram

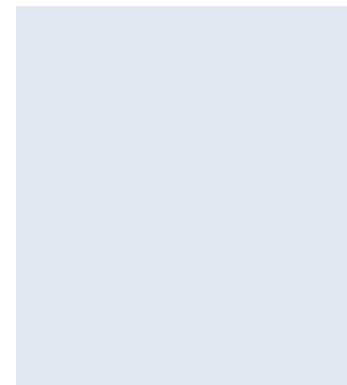
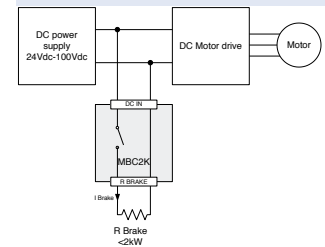

1. **SET / RESET:** Used to reset any errors and to change configurations in set-up mode.
2. **MENU:** Used to enter set-up mode and to navigate through the menu pages.
3. **Synchronisation bus connector:** used to connect up to 4 units in parallel.
4. **Braking resistor thermostat connector:** used to connect a thermostat present on the braking resistor (Klixson normally closed type is recommended; if not used, short-circuit the 2 terminals).
5. **Remote alarm connector:** an SPDT contact triggers the fault/malfunction signal.
6. **Braking resistor connector:** used to connect the external braking resistor.
7. **DC bus connector:** used to connect MBC2K to the 24 ...100Vdc DC bus power supply.
8. **Protective earth (PE) connector:** used to connect the device to the ground protection.
9. **100s display:** used to view numbers >99; e.g. if the indicator is on and the display reads "03", the measurement is 103V.
10. **Braking indicator:** indicates that the unit is braking the engine and supplying current to the braking R.
11. **7-segment display:** when the unit is in operation, this shows the DC bus voltage (accuracy +/-1V); it is also used to display menu items and error codes.
12. **Alarm LED:** indicates a fault or error status.

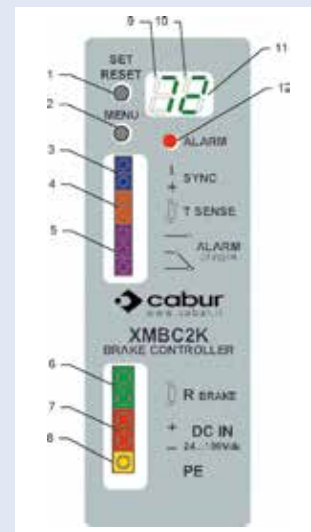

Figure 2 MBC2K - Front view

PROTECTIONS

- 20 threshold levels
- Braking power until 2 kW
- Braking power until 8 kW, with allowable parallel connection
- Simple function programming
- Braking resistor temperature control

NOTE

[1] Produced on demand, contact our sales office for availability

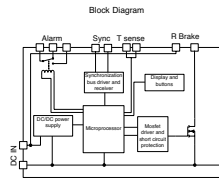

APPLICATIONS

MBC2K is a microprocessor-controlled device designed for braking DC bus-powered engines. It is activated by the surge generated by the engine when its drive requires braking.

When the MBC2K is connected on the DC bus powering the engine drive (see diagram in fig. 1), the device activates automatically when the DC bus voltage exceeds the set threshold and transfers the power generated by the engine to the braking resistor, where it is dissipated. MBC2k is equipped with protection against short circuit, overload and over temperature in order to guarantee reliable operation. MBC2K can be connected to any DC bus power supply with a voltage within 24 and 100 Vdc. The simplified application is illustrated in the block diagram in Figure 1, the front view of the unit with all controls and functions is shown in Figure 2. Connect up to 4 units in parallel to increase the peak braking power up to 8 KW. MBC2K also has a 7-segment display and an LED for instantly viewing the DC bus voltage (accuracy +/- 1 V) which helps the user during set-up and in displaying error messages.

CODE	MBC2K (1)	XMBC2K
TYPE	MBC2K (1)	
INPUT TECHNICAL DATA		
DC bus range	24...100 Vdc	
Maximum braking current	50 A for 1 s	
Operating voltage braking	27...106 V, threshold adjustable in 20 steps	
Threshold hysteresis	3 V or 6 V switchable	
User interface	2 setup buttons (SET/RESET and MENU) Two 7-segment displays 1 LED alarm status indicator (general) 1 SPDT remote failure contact (general)	
Protections	Under DC bus voltage (< 22 Vdc) Over DC bus voltage (> 110 Vdc) Braking resistor overtemperature (only where a thermostat is connected to the resistor) Module internal over temperature (temp. > 90°C) Braking resistor interrupted or not connected Short-circuit (or braking current > 80A) Overload (or braking time > 1 s)	
Parallel connection	Up to 4 MBC2Ks can be connected in parallel and synchronised through the bus to obtain a total peak braking power of 8 kW (with four 2 kW braking resistors).	
GENERAL TECHNICAL DATA		
Efficiency	—	
Dissipated power	20 W	
Operating temperature range	0...+70°C	
Input-output isolation	—	
Input-ground isolation	500 Vac / 60s	
Output ground isolation	—	
Standard approvals	EN60950 for SELV use up to 60 Vdc; use at higher voltages is not SELV classifiable	
EMC Standards	EN55011 Class B	
Overvoltage category pollution degree	II / 2	
Protection degree	IP 20	
Connection terminal IN-OUT	2.5 mm ² / 2.5 mm ²	
Housing material	aluminium	
Dimension	39x128x115	
Approximate weight	200 g	
Mounting information	vertical on a rail, 10 mm from adjacent components	
APPROVALS	CE	
ACCESSORIES		
Mounting rail (IEC60715/TH35-7.5)	PR/3/AC, PR/3/AC/ZB, PR/3/AS, PR/3/AS/ZB	
Mounting rail (IEC60715/TH35-15)	—	
Marking tag	—	

ADJUSTABLE ELECTRONIC OVERCURRENT PROTECTION FROM 1...10 A / 24 VDC



According to the new EN60204-1, it is **compulsory** to protect wires on SELV-PELV lines from overcurrent. The standard requires that 24 Vdc overcurrent protections intervene by cutting out the failure before the control and command 24 Vdc falls below 21.6V, cutting off power to the controls and preventing the emergency and safety features from activating.

Under EN 60204-1 and EN 61131-1 and -2, overcurrent protection on SELV/PELV lines must be capable of isolating shorts within 10 ms and hazardous overcurrents within 5 s. The use of power supplies with a high output overcurrent capacity and fast, accurate protections facilitates fault isolation before the 24 V falls below 21.6 V, leaving the controls without power.

Fuses and magneto-thermal switches inserted on 24 Vdc lines have characteristic intervention I/t s that are not suitable for isolating faults with the required speed and accuracy, while the fuses may be replaced with different types, affecting the behaviour of the protection and the safety of the system.

The proper coordination of the circuit in which the overcurrent protection is inserted must consider the total R of the line as: R connections + R wires + R protection + R residual malfunctioning load. The total R must always allow a safe current to circulate in the circuit once the protection is triggered and the protection should neither be undersized, to prevent undesirable bursts at peak load, nor oversized, to prolong its intervention t.

The entire circuit, including power supply, protection, wiring and connections, must be designed such that all overcurrents can be cut-off within 5 s before the 24 Vdc falls below 21.6 Vdc. This requirement can be met with Cabur's CSF and CSG series power supplies, designed to provide a high output overcurrent (nom. $I > +50\%$ for $> 5s$) and CEP System electronic overcurrent protections with an accuracy and speed far superior to magneto-thermal switches and fuses, whose trigger t is independent of ambient T and can be reset locally or remotely.

Protection features

MGTs have two different intervention curves: Thermal and magnetic. The magnetic relay only triggers in the event of a short with different I/t curves; thermal relays all have the same intervention curve regardless of the MGT curve and in the event of an overload they behave as shown in figure 2: overload currents of $1.13 \times I_n$ are cut in $> 1h$, and at overcurrent $> 1.45 \times I_n$, the trigger occurs in several minutes.

The disconnection of short-circuit currents is activated by the magnetic relay whose trigger t ranges from 0.01 to 0.1 s, and it occurs at very high currents which the power supply used may not be able to deliver: a C5 MGT used in DC has a safe trigger of $> 70 A$, a current which only (but not all) power supplies with a far higher nom. I, e.g. 40 A, are capable of providing, but which is not deliverable by 10 A power supplies.

Using MGT as an overcurrent protection, if the power supply used has an overload 1.2 times greater than its nominal I, disconnection will occur after 20...60 minutes, while with a current 2.5 times higher than the nominal I it will trigger after 25 s to 2 min., depending on the T_{amb} , times which are too long to guarantee stability at 24V to protect wiring and protection selectivity. In case of malfunction, until the protection triggers, the power supply remains in overload in excess of $x 1.5 \times 5 s$ and the 24 V falls below 21.6 V, leaving normal functions and particularly the safety functions without power.

Protection selectivity

In case of an overload or short, only the malfunctioning circuit is isolated from its protection without any effects on the power to the other loads. This feature is obtained using power supplies with a high overcurrent capacity and quick and precise protections.

CEP system – the smart current control system

CEP "recognises" overcurrent at the lowest and most precise threshold and isolates the malfunctioning circuit in the fastest possible time. For maximum flexibility of use, the CEP system allows you to set 10 trigger currents from 1 A to 10 A in 1 A increments, and has 3 intervention curves: "Rapid – Normal – Delayed" (see fig. 3).

The protection status is indicated by two LEDs and a remote alarm transistor output, while the load can be activated/deactivated using the button on the front (fig. 5) or controlled remotely by PLC. The ability to control individual channels separately is useful during installation since various components can be activated and tested individually, while in large plants, the remote control feature can be used to gradually activate the various loads, preventing multiple simultaneous overloads at system start-up.

An additional safety feature is manual disconnection, with which even when reactivating the protections remotely the load will remain inactive, preventing hazardous operating conditions.



Figure 1



Figure 3



Figure 4



Figure 5

PROTECTIONS

- Programmable from 1 A to 10 A
- 3 programmable characteristic curves
- Remote or local ON/OFF control
- Green ON/red OFF status LED and remote signalling
- Slide contact for manual disconnection
- Sealable front cover for programming protection

NOTE

Remote control is through 24 Vdc pulses. Such pulse durations should be: = impulse > 1 s / OFF = impulse > 100 ms and < 800 ms

The 3 standard characteristic curves are shown in the diagrams; the CEP-D3 version also has a software-programmable curve.

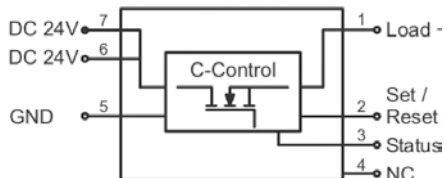

- 1) sealable cover
- 2) programming current
- 3) identification tag
- 4) programming intervention curve
- 5) replacing the fuse

CODE	XCEPD1
TYPE	CEP-D1
INPUT TECHNICAL DATA	
Input rated voltage	24 Vdc
Input voltage range	18...32 Vdc
Input current	10 A DC max
OUTPUT TECHNICAL DATA	
Output rated voltage	24 Vdc (caduta di tensione <170 mV a Un / In)
Continuous current	1 ... 10 A DC programmabili con incrementi di 1 A.
Max system current	40 A DC tramite barra di distribuzione CEP-RCC
Default trip curves	lenta, media e veloce
Max connectable output capacity	10,000 µF
Protection	elettronica, contro l'inversione di polarità
Remone On-OFF control	impulso 24 Vdc esterno
Status indication	LED verde: costante = OK, lampeggio = lout al 90% del valore nominale, LED rosso: costante = uscita spenta manualmente, lampeggio lento = sovracorrente, lampeggio veloce = errore
Alarm contact	transistor a collettore aperto (sovracorrente)
GENERAL TECHNICAL DATA	
Operating temperature range	-25...+60°C (derating -2 A >40°C)
Input / output isolation	3 kVac / 60 s (uscita SELV)
Standard / approvals	EN60950-1
EMC Standards	EN61131-1, EN61131-2, EN60898, EN60947-4-1, EN50081
Overvoltage category / Pollution degree	II / 2
Protection degree	IP 20
Connection terminal IN/OUT	2.5 mm ² / 2.5 mm ²
Housing material	materiale plastico UL94V-0
Dimension	8x115x116 mm
Approximate weight	120 g
Mounting information	verticale una guida, affiancati
APPROVALS	
ACCESSORIES	
Mounting rail (IEC60715/TH35-7.5)	PR/3/AC, PR/3/AC/ZB, PR/3/AS, PR/3/AS/ZB
Mounting rail (IEC60715/TH35-15)	—

Marking tag

- CEP-MTW (codice XCEPMTW, tabella con 50 cartellini)
- CEP-SS (codice XCEPSS)
- CEP-RCC (codice XCEPRCC)
- CEP-RCP (codice XCEPRCP)
- CEP-BCR (8 poli rosso)
- CEP-BCB (8 poli blu)

Characteristic curve:

- 1) fast
- 2) medium
- 3) slow

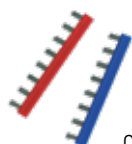
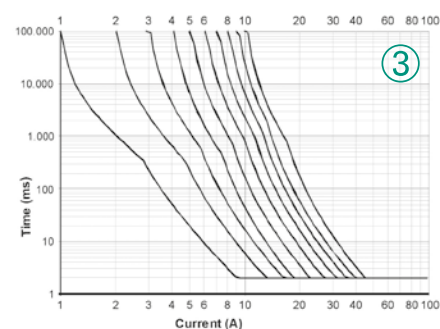
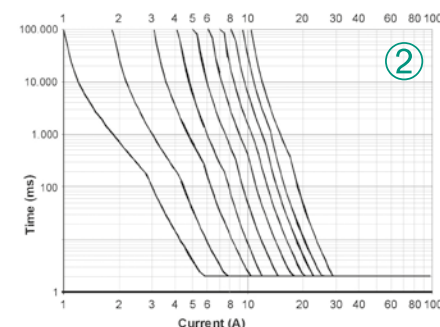
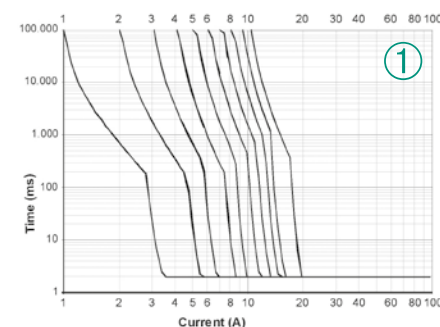

CEP-BCR and CEP-BCB



CEP-MTW



CEP-SS

- For single phase and three-phase systems
- Phase and neutral connection in a single cartridge
- Compact dimensions

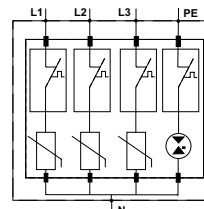
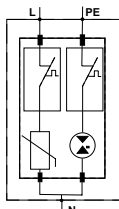

CODE	ISPD275AC1PNPE	ISPD275AC1PNPE	ISPD440AC3PNPE	ISPD440AC3PNPE
TYPE				
TECHNICAL DATA				
Test Class	II		II	
Earthing system	TN, IT, TT		TN, IT, TT	
Rated voltage (Un)	220 — 230 V		230 — 400 V	
Max. continuous voltage (Uc)	275 V		440 V	
Operating frequency	50 — 60 Hz		50 — 60 Hz	
Max. Discharge current (8/20µs) (In)	40 kA		40 kA	
Nominal discharge current (8/20µs) (Imax)	20 kA		20 kA	
Voltage protection level at In (Up)	1.5 kV		1.5 kV	
Protection mode	L — N / N — PE		L1, L2, L3 — N / N — PE	
Isolation resistance	> 10 ² MΩ		> 10 ² MΩ	
Response time	≤ 25 ns		≤ 25 ns	
Recommended back-up fuse ratings	125 A		125 A	
Internal protection fuse	already mounted		already mounted	
Max. cables section	25 mm ²		25 mm ²	
Fault indicator	red LED		red LED	
Alarm contact	—		—	
Operating temperature range	—40...+85 °C		—40...+85 °C	
Protection degree	IP20		IP20	
Housing material	UL94—V0 plastic material		UL94—V0 plastic material	
Dimension (WxHxD)	18x90x61 mm		36x90x61 mm	
Approximate weight	120 g		240 g	
Mounting information	vertical on rail, side by side		vertical on rail, side by side	
APPROVALS				

CE

CE

ACCESSORIES		
Parallel bridge 2 poles	—	—
Parallel bridge 3 poles	—	—
Parallel bridge 4 poles	—	—

Single phase and 3-phase industrial EMI filters

- Models from 7 to 130 A
- Elevated attenuation from 150 kHz to 30 MHz
- Elevated attenuation even on long cables
- Compact dimension



NOTE

[1] Isolation test need to be made in DC voltage, according to EN 60950, cause by the internal filter capacitors

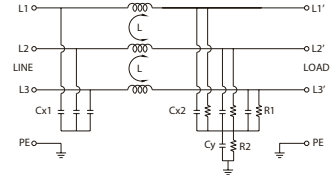
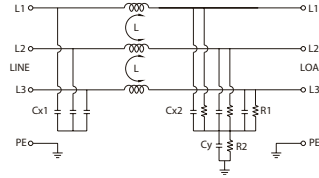
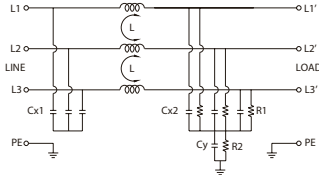

CODE	XF07TDVST2	XF16TDVST2	XF30TDVST2
GENERAL TECHNICAL DATA			
Rated voltage	480 Vac ± 10%	480 Vac ± 10%	480 Vac ± 10%
Rated current	7 A	16 A	30 A
Leakage current	30 mA	30 mA	30 mA
Frequency	50...60 Hz	50...60 Hz	50...60 Hz
Operating temperature range	-25...+85°C	-25...+85°C	-25...+85°C
Isolation L/L	1.45 kVdc / 60 s [1]	1.45 kVdc / 60 s [1]	1.45 kVdc / 60 s [1]
Isolation L/PE	2.25 kVdc / 60 s [1]	2.25 kVdc / 60 s [1]	2.25 kVdc / 60 s [1]
Overvoltage category / Pollution degree	—	—	—
Protection degree	IP 20	IP 20	IP 20
Connection terminal IN/OUT	fixed screw terminal blocks	fixed screw terminal blocks	fixed screw terminal blocks
Housing material	metallic	metallic	metallic
Dimension	42x192x72 mm	47x252x72 mm	52x272x87 mm
Approximate weight	—	—	—
Mounting information	screw fixing, on metal panel	screw fixing, on metal panel	screw fixing, on metal panel
APPROVALS			
Common mode (L/PE) attenuation (dB)			
0.15 MHz	20	15	15
0.5 MHz	60	50	50
1 MHz	60	55	55
5 MHz	60	60	60
10 MHz	50	50	50
30 MHz	35	35	35
Differential mode (L/PE) attenuation (dB)			
0.15 MHz	25	25	25
0.5 MHz	60	55	55
1 MHz	65	60	60
5 MHz	60	60	60
10 MHz	55	55	55
30 MHz	40	40	40
ACCESSORIES			
Marking tag	—	—	—

- Models from 7 to 130 A
- Elevated attenuation from 150 kHz to 30 MHz
- Elevated attenuation even on long cables
- Compact dimension



NOTE

[1] Isolation test need to be made in DC voltage, according to EN 60950, cause by the internal filter capacitors

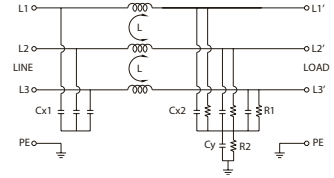
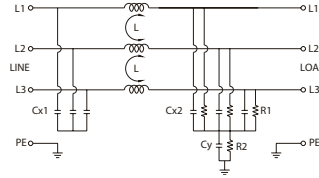
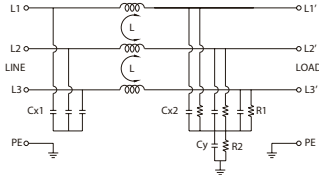

CODE TYPE	F42TDVST2	XF42TDVST2	F55TDVST2	XF55TDVST2	F75TDVST2	XF75TDVST2
GENERAL TECHNICAL DATA						
Rated voltage	480 Vac ± 10%		480 Vac ± 10%		480 Vac ± 10%	
Rated current	42 A		55 A		75 A	
Leakage current	30 mA		30 mA		30 mA	
Frequency	50...60 Hz		50...60 Hz		50...60 Hz	
Operating temperature range	-25...+85°C		-25...+85°C		-25...+85°C	
Isolation L/L	1.45 kVdc / 60 s [1]		1.45 kVdc / 60 s [1]		1.45 kVdc / 60 s [1]	
Isolation L/PE	2.25 kVdc / 60 s [1]		2.25 kVdc / 60 s [1]		2.25 kVdc / 60 s [1]	
Overvoltage category / Pollution degree	—		—		—	
Protection degree	IP 20		IP 20		IP 20	
Connection terminal IN/OUT	fixed screw terminal blocks		fixed screw terminal blocks		fixed screw terminal blocks	
Housing material	metallic		metallic		metallic	
Dimension	52x312x87 mm		87x252x92 mm		92x272x137 mm	
Approximate weight	—		—		—	
Mounting information	screw fixing, on metal panel		screw fixing, on metal panel		screw fixing, on metal panel	
APPROVALS						
Common mode (L/PE) attenuation (dB)						
0.15 MHz	55		15		15	
0.5 MHz	70		55		55	
1 MHz	70		55		55	
5 MHz	45		55		55	
10 MHz	35		50		50	
30 MHz	20		35		30	
Differential mode (L/PE) attenuation (dB)						
0.15 MHz	45		25		20	
0.5 MHz	45		55		50	
1 MHz	45		60		50	
5 MHz	45		60		50	
10 MHz	45		50		55	
30 MHz	30		40		40	
ACCESSORIES						
Marking tag	—		—		—	

- Models from 7 to 130 A
- Elevated attenuation from 150 kHz to 30 MHz
- Elevated attenuation even on long cables
- Compact dimension



NOTE

[1] Isolation test need to be made in DC voltage, according to EN 60950, cause by the internal filter capacitors

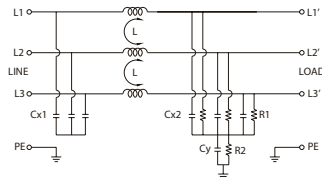

CODE	XF100TDVST2
TYPE	F100TDVST2
GENERAL TECHNICAL DATA	
Rated voltage	480 Vac ± 10%
Rated current	100 A
Leakage current	30 mA
Frequency	50...60 Hz
Operating temperature range	-25...+85°C
Isolation L/L	1.45 kVdc / 60 s [1]
Isolation L/PE	2.25 kVdc / 60 s [1]
Overvoltage category / Pollution degree	—
Protection degree	IP 20
Connection terminal IN/OUT	fixed screw terminal blocks
Housing material	metallic
Dimension	90x270x150 mm
Approximate weight	—
Mounting information	screw fixing, on metal panel
APPROVALS	
Common mode (L/PE) attenuation (dB)	
0.15 MHz	35
0.5 MHz	50
1 MHz	45
5 MHz	25
10 MHz	15
30 MHz	7
Differential mode (L/PE) attenuation (dB)	
0.15 MHz	30
0.5 MHz	35
1 MHz	35
5 MHz	35
10 MHz	30
30 MHz	7
ACCESSORIES	
Marking tag	—

- Models from 150 to 180 A
- Elevated attenuation from 150 kHz to 30 MHz
- Elevated attenuation even on long cables

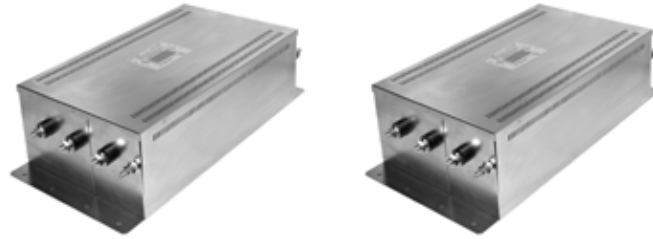

NOTE

- (1) Produced on demand, contact our sales office for availability
 (2) Isolation test need to be made in DC voltage, according to EN 60950, cause by the internal filter capacitors.

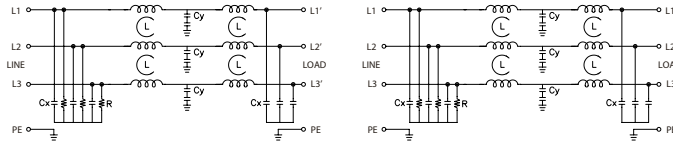

CODE	XF150TDS84C	XF180TDS84C
TYPE	F150TDS84C (1)	F180TDS84C (1)
GENERAL TECHNICAL DATA		
Rated voltage	480 Vac ± 10%	480 Vac ± 10%
Rated current	150 A	180 A
Leakage current	500 mA	500 mA
Frequency	50...60 Hz	50...60 Hz
Operating temperature range	-25...+85°C	-25...+85°C
Isolation L/L	1 kVdc / 60 s [2]	1 kVdc / 60 s [2]
Isolation L/PE	1 kVdc / 60 s [2]	2.25 kVdc / 60 s [2]
Overvoltage category / Pollution degree	—	—
Protection degree	IP 00	IP 00
Connection terminal IN/OUT	self-blocking nut	self-blocking nut
Housing material	metallic	metallic
Dimension	202x390x122 mm	202x390x122 mm
Approximate weight	—	—
Mounting information	screw fixing, on metal panel	screw fixing, on metal panel
APPROVALS		
Common mode (L/PE) attenuation (dB)		
0.15 MHz	20	20
0.5 MHz	30	30
1 MHz	40	40
5 MHz	45	45
10 MHz	40	40
30 MHz	30	30
Differential mode (L/PE) attenuation (dB)		
0.15 MHz	30	30
0.5 MHz	40	40
1 MHz	40	40
5 MHz	45	45
10 MHz	40	40
30 MHz	25	25
ACCESSORIES		
Marking tag	—	—

- Models from 10 to 20 A
- Elevated attenuation from 150 kHz to 30 MHz
- Elevated attenuation even on long cables
- Excellent quality/price/performance ratio



NOTE

(1) Produced on demand, contact our sales office for availability
 (2) Isolation test need to be made in DC voltage, according to EN 60950, cause by the internal filter capacitors.

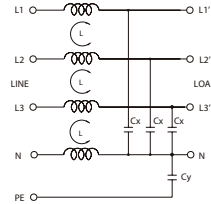
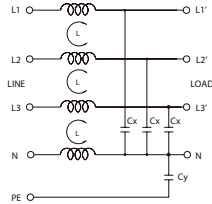

CODE TYPE	XF10TYG9 F10TYG9 (1)	XF20TYS9 F20TYS9 (1)
GENERAL TECHNICAL DATA		
Rated voltage	440 Vac ± 10%	440 Vac ± 10%
Rated current	10 A	20 A
Leakage current	0.5 mA	1.92 mA
Frequency	50...60 Hz	50...60 Hz
Operating temperature range	-25...+85°C	-25...+85°C
Isolation L/L	1.45 kVdc / 60 s [2]	1.45 kVdc / 60 s [2]
Isolation L/PE	2.25 kVdc / 60 s [2]	2.25 kVdc / 60 s [2]
Overvoltage category / Pollution degree	—	—
Protection degree	IP 00	IP 00
Connection terminal IN/OUT	flat plug (10 A) and screw (20 A)	flat plug (10 A) and screw (20 A)
Housing material	metallic	metallic
Dimension	50x85x44mm	50.3x85x44mm
Approximate weight	—	—
Mounting information	screw fixing, on metal panel	screw fixing, on metal panel
APPROVALS		
Common mode (L/PE) attenuation (dB)		
0.15 MHz	10	10
0.5 MHz	20	15
1 MHz	20	20
5 MHz	20	35
10 MHz	30	40
30 MHz	25	25
Differential mode (L/PE) attenuation (dB)		
0.15 MHz	10	10
0.5 MHz	20	15
1 MHz	25	20
5 MHz	25	20
10 MHz	30	25
30 MHz	30	20
ACCESSORIES		
Marking tag	—	—

- Models from 36 to 100 A
- Elevated attenuation from 150 kHz to 30 MHz
- Elevated attenuation even on long cables

NOTE

(1) Produced on demand, contact our sales office for availability
 (2) Isolation test need to be made in DC voltage, according to EN 60950, cause by the internal filter capacitors.

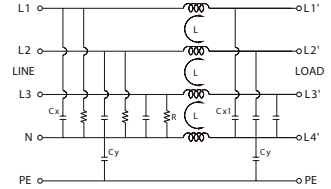
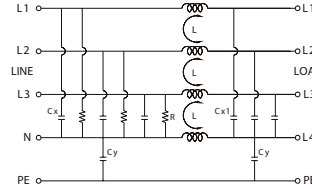
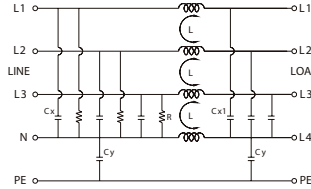

CODE TYPE	XF36TYT8	XF50TYT8	XF100TYT8
GENERAL TECHNICAL DATA			
Rated voltage	440 Vac ± 10%	440 Vac ± 10%	440 Vac ± 10%
Rated current	36 A	50 A	100 A
Leakage current	3 mA	3 mA	1.3 mA
Frequency	50...60 Hz	50...60 Hz	50...60 Hz
Operating temperature range	-25...+85°C	-25...+85°C	-25...+85°C
Isolation L/L	1.45 kVdc / 60 s [2]	1.45 kVdc / 60 s [2]	1.45 kVdc / 60 s [2]
Isolation L/PE	2.25 kVdc / 60 s [2]	2.25 kVdc / 60 s [2]	2.25 kVdc / 60 s [2]
Overvoltage category / Pollution degree	—	—	—
Protection degree	IP 20	IP 20	IP 20
Connection terminal IN/OUT	fixed screw terminal blocks	fixed screw terminal blocks	fixed screw terminal blocks
Housing material	metallic	metallic	metallic
Dimension	107x191.5x82 mm	124x194x104 mm	162x252x132 mm
Approximate weight	—	—	—
Mounting information	screw fixing, on metal panel	screw fixing, on metal panel	screw fixing, on metal panel
APPROVALS			
Common mode (L/PE) attenuation (dB)			
0.15 MHz	25	25	10
0.5 MHz	50	45	20
1 MHz	50	45	25
5 MHz	50	40	30
10 MHz	40	40	30
30 MHz	25	25	20
Differential mode (L/PE) attenuation (dB)			
0.15 MHz	30	30	30
0.5 MHz	50	50	40
1 MHz	55	50	40
5 MHz	50	40	35
10 MHz	40	40	35
30 MHz	30	30	25
ACCESSORIES			
Marking tag	—	—	—

- Models from 3 to 30 A
- Elevated attenuation from 150 kHz to 30 MHz
- Elevated attenuation even on long cables
- Compact dimension



NOTE

(1) Produced on demand, contact our sales office for availability
 (2) Isolation test need to be made in DC voltage, according to EN 60950, cause by the internal filter capacitors.

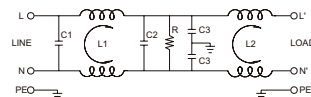
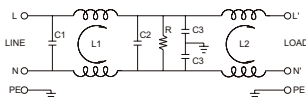
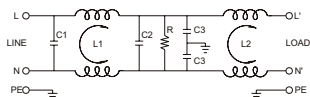

CODE TYPE	XF03DKBG5B F03DKBG5B (1)	XF06DKBG5B F06DKBG5B (1)	XF12DKBG5B F12DKBG5B
GENERAL TECHNICAL DATA			
Rated voltage	115-250 Vac ± 10%	115-250 Vac ± 10%	115-250 Vac ± 10%
Rated current	3 A	6 A	12 A
Leakage current	0.40 mA (115 Vac) / 0.80 mA (250 Vac)	0.40 mA (115 Vac) / 0.80 mA (250 Vac)	0.40 mA (115 Vac) / 0.80 mA (250 Vac)
Frequency	50...60 Hz	50...60 Hz	50...60 Hz
Operating temperature range	-25...+100°C	-25...+100°C	-25...+100°C
Isolation L/L	1.45 kVdc / 60 s [2]	1.45 kVdc / 60 s [2]	1.45 kVdc / 60 s [2]
Isolation L/PE	2.25 kVdc / 60 s [2]	2.25 kVdc / 60 s [2]	2.25 kVdc / 60 s [2]
Overvoltage category / Pollution degree	—	—	—
Protection degree	IP 00	IP 00	IP 00
Connection terminal IN/OUT	flat plug (from 3 to 20 A) / self-blocking nut (30 A)	flat plug (from 3 to 20 A) / self-blocking nut (30 A)	flat plug (from 3 to 20 A) / self-blocking nut (30 A)
Housing material	metallic	metallic	metallic
Dimension	64.5x34x30 mm	64.5x34x30 mm	64.5x34x30 mm
Approximate weight	—	—	—
Mounting information	screw fixing, on metal panel	screw fixing, on metal panel	screw fixing, on metal panel
APPROVALS			
Common mode (L/PE) attenuation (dB)			
0.15 MHz	20	15	10
0.5 MHz	30	20	20
1 MHz	35	25	22
5 MHz	45	40	35
10 MHz	50	45	45
30 MHz	45	45	40
Differential mode (L/PE) attenuation (dB)			
0.15 MHz	7	10	10
0.5 MHz	35	20	20
1 MHz	50	45	40
5 MHz	45	45	45
10 MHz	45	50	45
30 MHz	45	45	45
ACCESSORIES			
Marking tag	—	—	—

- Models from 3 to 30 A
- Elevated attenuation from 150 kHz to 30 MHz
- Elevated attenuation even on long cables
- Compact dimension



NOTE

(1) Produced on demand, contact our sales office for availability
 (2) Isolation test need to be made in DC voltage, according to EN 60950, cause by the internal filter capacitors.

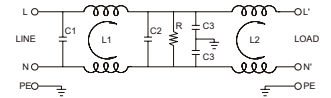
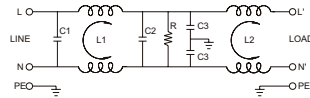
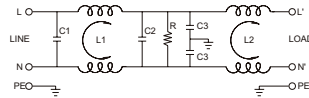

CODE TYPE	XF16DKCG5B	XF20DKCG5B	XF20DKCG5B (1)	XF30DKCG5B
GENERAL TECHNICAL DATA				
Rated voltage	115-250 Vac ± 10%	115-250 Vac ± 10%	115-250 Vac ± 10%	115-250 Vac ± 10%
Rated current	16 A	20 A	20 A	30 A
Leakage current	0.40 mA (115 Vac) / 0.80 mA (250 Vac)	0.40 mA (115 Vac) / 0.80 mA (250 Vac)	0.40 mA (115 Vac) / 0.80 mA (250 Vac)	1 mA (115Vac) / 2mA (250Vac)
Frequency	50...60 Hz	50...60 Hz	50...60 Hz	50...60 Hz
Operating temperature range	-25...+100°C	-25...+100°C	-25...+100°C	-25...+100°C
Isolation L/L	1.45 kVdc / 60 s [2]	1.45 kVdc / 60 s [2]	1.45 kVdc / 60 s [2]	1.45 kVdc / 60 s [2]
Isolation L/PE	2.25 kVdc / 60 s [2]	2.25 kVdc / 60 s [2]	2.25 kVdc / 60 s [2]	2.25 kVdc / 60 s [2]
Overvoltage category / Pollution degree	—	—	—	—
Protection degree	IP 00	IP 00	IP 00	IP 00
Connection terminal IN/OUT	flat plug (from 3 to 20 A) / self-blocking nut (30 A)	flat plug (from 3 to 20 A) / self-blocking nut (30 A)	flat plug (from 3 to 20 A) / self-blocking nut (30 A)	flat plug (from 3 to 20 A) / self-blocking nut (30 A)
Housing material	metallic	metallic	metallic	metallic
Dimension	45.5x71.5x30 mm	52x84.8x30 mm	52x84.8x30 mm	56.5x114x46.4 mm
Approximate weight	—	—	—	—
Mounting information	screw fixing, on metal panel	screw fixing, on metal panel	screw fixing, on metal panel	screw fixing, on metal panel
APPROVALS				
Common mode (L/PE) attenuation (dB)				
0.15 MHz	10	10	10	10
0.5 MHz	18	18	18	25
1 MHz	20	20	20	30
5 MHz	35	30	30	45
10 MHz	45	35	35	50
30 MHz	30	35	35	35
Differential mode (L/PE) attenuation (dB)				
0.15 MHz	10	10	10	12
0.5 MHz	18	12	12	40
1 MHz	40	35	35	50
5 MHz	40	35	35	50
10 MHz	40	40	40	50
30 MHz	35	40	40	45
ACCESSORIES				
Marking tag	—	—	—	—

- Models from 3 to 30 A
- Elevated attenuation from 150 kHz to 30 MHz
- Elevated attenuation even on long cables
- Compact dimension



NOTE

- (1) Produced on demand, contact our sales office for availability
 (2) Isolation test need to be made in DC voltage, according to EN 60950, cause by the internal filter capacitors.

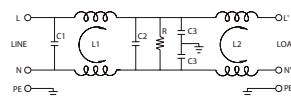
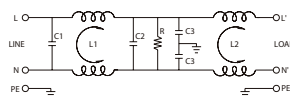
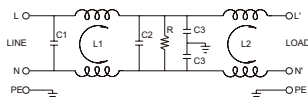

CODE TYPE	XF03DPCG5C	XF06DPCG5C	XF12DPCG5C
GENERAL TECHNICAL DATA			
Rated voltage	115-250 Vac ± 10%	115-250 Vac ± 10%	115-250 Vac ± 10%
Rated current	3 A	6 A	12 A
Leakage current	0.40 mA (115 Vac) / 0.80 mA (250 Vac)	0.40 mA (115 Vac) / 0.80 mA (250 Vac)	0.40 mA (115 Vac) / 0.80 mA (250 Vac)
Frequency	50...60 Hz	50...60 Hz	50...60 Hz
Operating temperature range	-25...+100°C	-25...+100°C	-25...+100°C
Isolation L/L	1.45 kVdc / 60 s [2]	1.45 kVdc / 60 s [2]	1.45 kVdc / 60 s [2]
Isolation L/PE	2.25 kVdc / 60 s [2]	2.25 kVdc / 60 s [2]	2.25 kVdc / 60 s [2]
Overvoltage category / Pollution degree	—	—	—
Protection degree	IP 00	IP 00	IP 00
Connection terminal IN/OUT	flat plug (from 3 to 20 A) / self-blocking nut (30 A)	flat plug (from 3 to 20 A) / self-blocking nut (30 A)	flat plug (from 3 to 20 A) / self-blocking nut (30 A)
Housing material	metallic	metallic	metallic
Dimension	45.5x71.5x30 mm	45.5x71.5x30 mm	52x84.8x29.2mm
Approximate weight	—	—	—
Mounting information	screw fixing, on metal panel	screw fixing, on metal panel	screw fixing, on metal panel
APPROVALS			
Common mode (L/PE) attenuation (dB)			
0.15 MHz	45	30	15
0.5 MHz	60	50	25
1 MHz	60	60	35
5 MHz	55	55	55
10 MHz	45	50	55
30 MHz	45	35	35
Differential mode (L/PE) attenuation (dB)			
0.15 MHz	12	8	12
0.5 MHz	45	45	40
1 MHz	45	45	40
5 MHz	45	45	35
10 MHz	45	45	35
30 MHz	45	45	40
ACCESSORIES			
Marking tag	—	—	—

- Models from 3 to 30 A
- Elevated attenuation from 150 kHz to 30 MHz
- Elevated attenuation even on long cables
- Compact dimension



NOTE

- (1) Produced on demand, contact our sales office for availability
 (2) Isolation test need to be made in DC voltage, according to EN 60950, cause by the internal filter capacitors.

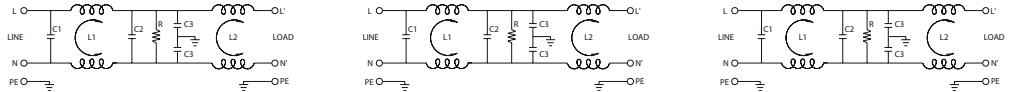

CODE TYPE	XF16DPCG5C	XF20DPCG5C	XF30DPCG5C
GENERAL TECHNICAL DATA			
Rated voltage	115-250 Vac ± 10%	115-250 Vac ± 10%	115-250 Vac ± 10%
Rated current	16 A	20 A	30 A
Leakage current	0.40 mA (115 Vac) / 0.80 mA (250 Vac)	0.40 mA (115 Vac) / 0.80 mA (250 Vac)	1 mA (115 Vac) / 2mA (250 Vac)
Frequency	50...60 Hz	50...60 Hz	50...60 Hz
Operating temperature range	-25...+100°C	-25...+100°C	-25...+100°C
Isolation L/L	1.45 kVdc / 60 s [2]	1.45 kVdc / 60 s [2]	1.45 kVdc / 60 s [2]
Isolation L/PE	2.25 kVdc / 60 s [2]	2.25 kVdc / 60 s [2]	2.25 kVdc / 60 s [2]
Overvoltage category / Pollution degree	—	—	—
Protection degree	IP 00	IP 00	IP 00
Connection terminal IN/OUT	flat plug (from 3 to 20 A) / self-blocking nut (30 A)	flat plug (from 3 to 20 A) / self-blocking nut (30 A)	flat plug (from 3 to 20 A) / self-blocking nut (30 A)
Housing material	metallic	metallic	metallic
Dimension	52x84.8x39.2 mm	56.5x114.0x46.4 mm	86x120x58 mm
Approximate weight	—	—	—
Mounting information	screw fixing, on metal panel	screw fixing, on metal panel	screw fixing, on metal panel
APPROVALS			
Common mode (L/PE) attenuation (dB)			
0.15 MHz	20	15	10
0.5 MHz	35	40	30
1 MHz	45	45	35
5 MHz	60	50	55
10 MHz	50	50	45
30 MHz	35	40	30
Differential mode (L/PE) attenuation (dB)			
0.15 MHz	12	12	18
0.5 MHz	40	45	45
1 MHz	40	45	50
5 MHz	45	40	40
10 MHz	45	35	40
30 MHz	50	50	40
ACCESSORIES			
Marking tag	—	—	—

Blank lined area for notes.

Converters

Isolation and
conversion
of analogue signals

Applications of analogue converters and galvanic separation

They convert electrical signals generated by sensors which take physical measurements such as temperature (thermocouples and PT100 resistance thermometers), frequency (proximity, contacts, photocells), current (TA, Hall sensors), resistance (potentiometers), voltage, pressure, level, etc. into standardised electrical signals, adapting them to PLC, DCS and industrial PC (control) outputs, or they convert a given analogue signal into a different one, adapting it to control inputs/outputs or allowing for long-distance signal transmission without interference by means of galvanic separation (fig. 1).

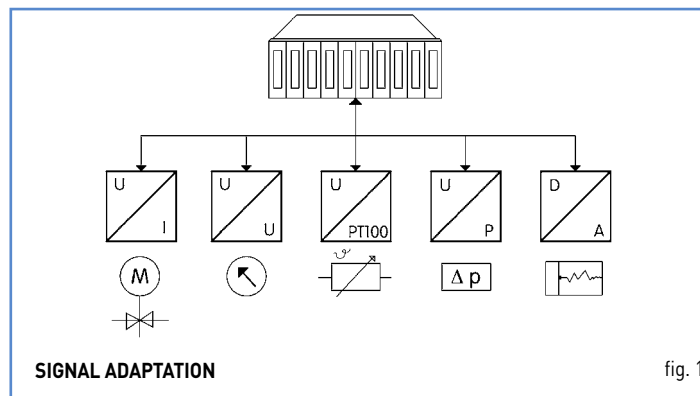

fig. 1

Adaptation between sensor output signal and control input signal

physical measurement taken	sensor output	converter input	converter output
Temperature	Normally one of the following signals indicated in the next column	0 – 60 mV ±60 mV	0 – 5 V ±5 V
Frequency		0 – 100 mV ±100 mV	0 – 10 V ±10 V
Current		0 – 500 mV ±500 mV	0 – 20 mA ±20 mA
Resistance		0 – 1 V ±1 V	4 – 20 mA
Voltage		0 – 5 V ±5 V	
Pressure		0 – 10 V ±10 V	
Level measurement		0 – 5 mA ±5 mA	
		0 – 10 mA ±10 mA	
		0 – 20 mA ±20 mA	
		0 – 20 mA	

Long-distance signal transmission

Voltage signals can reach a max. distance of 10-20 m, beyond which they lose reliability and become highly sensitive to induced and ground-derived interference, therefore in order to transmit to distances beyond 20 m a voltage signal must be converted into a current signal and galvanically separated (fig. 2).

Current signals can surpass a transmission distance of 300 m and are less sensitive to induced interference. The long-distance transmission of a current signal requires galvanic separation.

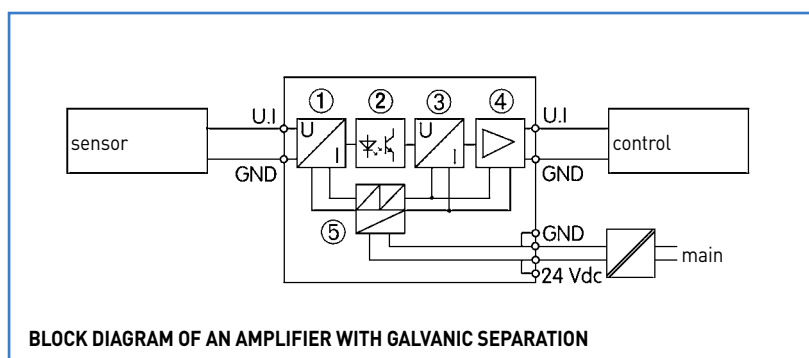

- ① Input amplifier
- ② Opto-isolator
- ③ Signal adapter
- ④ Output amplifier
- ⑤ DC/DC Converter

BLOCK DIAGRAM OF AN AMPLIFIER WITH GALVANIC SEPARATION

Galvanic signal separation (signal isolation):

- isolates and electrically separates the sensor circuit from the control circuit and from the power supply circuit; each circuit therefore operates in relation to its own zero potential which, being isolated from other circuits, cannot be altered by ever-present potential differences between different ground references (fig.3)

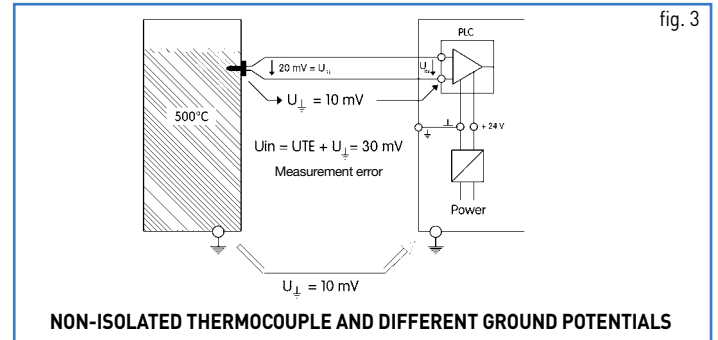

- isolates and separates different ground potentials between power supply, control and sensors/actuators
- allows for signal transmission without errors or interference and with greater reliability
- the higher the isolation (in kV), the greater the security of the transmission in the presence of ground potentials, electromagnetic or temporary interference (lightning, discharge, etc.). (fig 4)

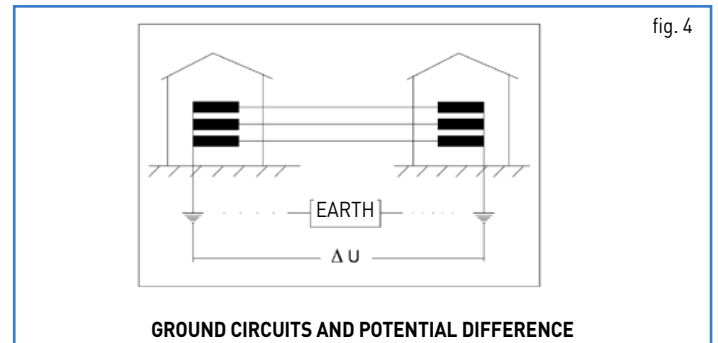

Galvanic separation is necessary when:

- the distance between control and sensor/actuator is greater than 20 m
- ground or mass references are different
- ground potentials are high, or may become high in case of discharges or currents leaked to ground
- electromagnetic interference is present
- signal cables are wired in ducts with power cables (fig. 5)

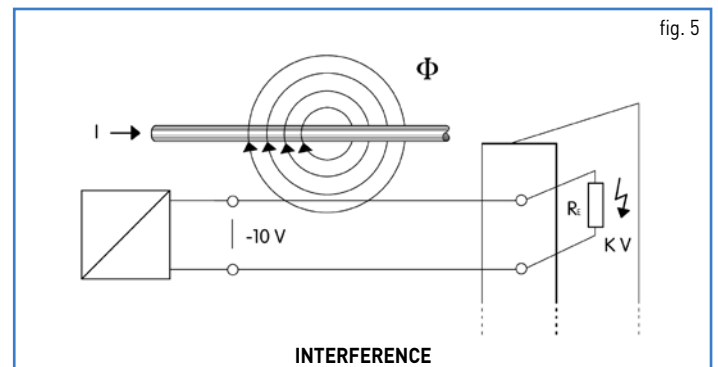

Connection of analogue converters in series and in parallel

- To obtain signal redundancy or to simply duplicate it, multiple converter inputs can be connected to a single sensor.
- In case of current signals, the converter input will be connected in series (fig. 6)

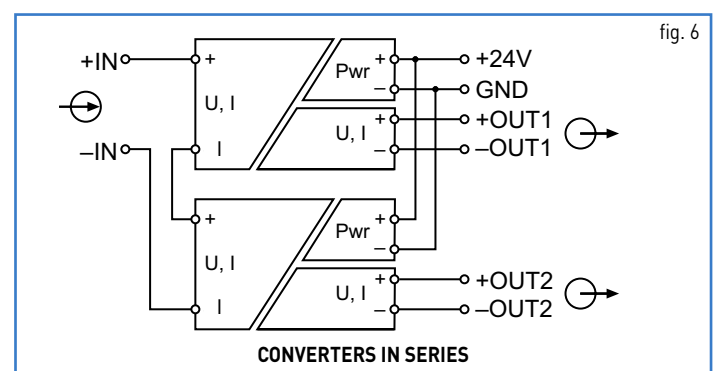

- In case of voltage signals, the converter input will be connected in parallel (fig. 7)

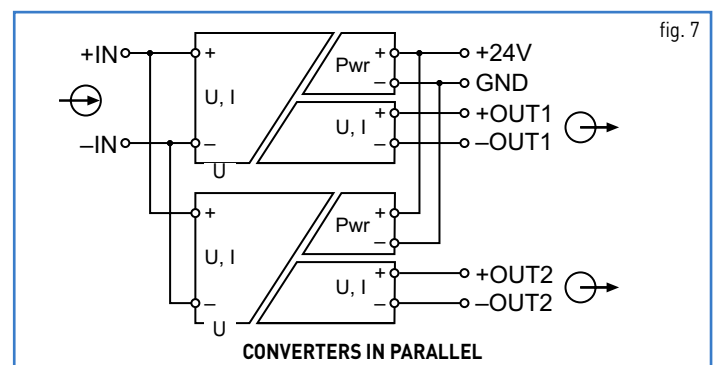

CONVERTERS - QUICK SELECTION TABLE



INPUT RANGE	OUTPUT RANGE	POWER SUPPLY VOLTAGE	INSULATION TYPE	PARAMETRIZATION	CODE	TYPE	PAGE
19 programmable range	7 programmable steps	24 Vdc (15...36 Vdc)	3-ways	DIP switch	XCAPI03	CAPI03	92
0...60 / 0...100 / 0...300 / 0...500 mV 0...1 / 0...10 / 0...20 / 2...20 V 0...5 / 0...10 / 0...20 / 4...20 / ±5 / ±20 mA	"0...10 V 0...20 / 4...20 mA"	24 Vac/dc (16.8...30 Vdc / 19.2...28.8 Vac)	3-ways	DIP switch	X756516	CWUAA 6-0516	93
0...10 V 0...20 / 4...20 mA	"0...10 V 0...20 / 4...20 mA"	24 Vac/dc (16.8...30 Vdc / 19.2...28.8 Vac)	3-ways	DIP switch	X756539	CWNAA-7-0539	94
0...10 V	0...10 V	24 Vac/dc (16.8...30 Vdc / 19.2...28.8 Vac)	3-ways	—	X756530	CWAA 7-0530	95
0...10 V	0...20 mA	24 Vac/dc (16.8...30 Vdc / 19.2...28.8 Vac)	3-ways	—	X756531	CWAA 7-0531	95
0...10 V	4...20 mA	24 Vac/dc (16.8...30 Vdc / 19.2...28.8 Vac)	3-ways	—	X756532	CWAA 7-0532	95
0...20 mA	0...10 V	24 Vac/dc (16.8...30 Vdc / 19.2...28.8 Vac)	3-ways	—	X756533	CWAA 7-0533	96
0...20 mA	0...20 mA	24 Vac/dc (16.8...30 Vdc / 19.2...28.8 Vac)	3-ways	—	X756534	CWAA 7-0534	96
0...20 mA	4...20 mA	24 Vac/dc (16.8...30 Vdc / 19.2...28.8 Vac)	3-ways	—	X756535	CWAA 7-0535	96
4...20 mA	0...10 V	24 Vac/dc (16.8...30 Vdc / 19.2...28.8 Vac)	3-ways	—	X756536	CWAA 7-0536	97
4...20 mA	0...20 mA	24 Vac/dc (16.8...30 Vdc / 19.2...28.8 Vac)	3-ways	—	X756537	CWAA 7-0537	97
4...20 mA	4...20 mA	24 Vac/dc (16.8...30 Vdc / 19.2...28.8 Vac)	3-ways	—	X756538	CWAA 7-0538	97
0...20 mA, 4...20 mA	0...20 / 4...20 mA, (max 21 mA)	—	2-ways	—	X756526	CWPAA 7-0526	98
0...10 V / 0...20 mA / 4...20 mA	0...10 V / 0...20 mA / 4...20 mA	24 Vdc (16.8...30 Vdc)	4-ways	DIP switch	X756321	LCON AASP	99
0...1 A AC/DC	0...10 V / 0...20 mA / 4...20 mA	24 Vdc (16.8...30 Vdc)	3-ways	DIP switch	X756540	WAA 7-0540	103
0...5 A AC/DC	0...10 V / 0...20 mA / 4...20 mA	24 Vdc (16.8...30 Vdc)	3-ways	DIP switch	X756541	WAA 7-0541	103
0...10 A AC/DC	0...10 V / 0...20 mA / 4...20 mA	24 Vdc (16.8...30 Vdc)	3-ways	DIP switch	X756542	WAA 7-0542	103
0...28.8 kHz (AC/DC 0.8...30 Vpp)	"0...10 V, (max. 10.6 V) 0...20 / 4...20 mA, (max 21 mA)"	24 Vac/dc (16.8...30 Vdc / 19.2...28.8 Vac)	3-ways	DIP switch	X756524	CWNFA 6-0524	104

CONVERTERS - QUICK SELECTION TABLE



INPUT RANGE	OUTPUT RANGE	POWER SUPPLY VOLTAGE	INSULATION TYPE	PARAMETRIZATION	CODE	TYPE	PAGE
-200...+2400°C, a seconda del sensore (2)	0...10 V/0...20 mA/0...20 mA	24 Vdc (16.8...30 Vdc)	3-ways	DIP switch, FDT/DTM software	X756340	LCONTAD	100
-50...+50°C (-58...+122°F) -50...+100°C (-58...+212°F) -50...+150°C (-58...+302°F) 0...+100°C (+32...+212°F) 0...+150°C (+32...+302°F) 0...+200°C (+32...+392°F) 0...+300°C (+32...+572°F) 0...+400°C (+32...+752°F)"	"0...10 V 0...20 / 4...20 mA"	24 Vac/dc (16.8...30 Vdc / 19.2...28.8 Vac)	3-ways	DIP switch	X756816	CWPT 6-0816	101
-50...+200°C (-58...+392°F) -50...+350°C (-58...+662°F) 0...+200°C (+32...+392°F) 0...+400°C (+32...+752°F) 0...+600°C (+32...+1112°F) 0...+800°C (+32...+1472°F) 0...+1000°C (+32...+1832°F) 0...+1200°C (+32...+2192°F)	"0...10 V 0...20 / 4...20 mA"	24 Vac/dc (16.8...30 Vdc / 19.2...28.8 Vac)	3-ways	DIP switch	X756844	CWTH 6-0844	102
0...28.8 kHz (AC/DC 0.8...30 Vpp)	"0...10 V, (max. 10.6 V) 0...20 / 4...20 mA, (max 21 mA)"	24 Vac/dc (16.8...30 Vdc / 19.2...28.8 Vac)	3-ways	DIP switch	X756524	CWNFA 6-0524	104

ANALOG SIGNAL CONVERTERS PROGRAMMABLE GALVANIC ISOLATOR



- Input: 19 selectable ranges
- Output: 7 selectable ranges
- Insulation: 3.0 kVac, 3-way isolation
- Auxiliary supply for loop powered sensors
- Auxiliary supply for potentiometer

NOTE
Factory setting: 0...10 V Input / 0...10 V output

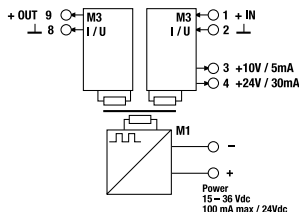

TAB.1 - INPUT SELECTION TABLE

INPUT RANGE		SW1 (INPUT)							
UNIPOLAR	BIPOLAR	1	2	3	4	5	6	7	8
0 - 60 mV	± 60 mV								
0 - 100 mV	± 100 mV		•						
0 - 500 mV	± 500 mV			•					
0 - 1 V	± 1 V				•				
0 - 2 V	± 2 V					•			
0 - 5 V	± 5 V			•	•	•			
0 - 10 V	± 10 V								•
0 - 5 mA	± 5 mA	•		•					
0 - 10 mA	± 10 mA	•			•				
0 - 20 mA	± 20 mA	•						•	
4 - 20 mA	—	•					•		•

TAB.2 - OUTPUT SELECTION TABLE

OUTPUT RANGE	INPUT TYPE	SW2 (OUTPUT)								SW3
		1	2	3	4	5	6	7	8	
0 - 5 V	UNIP.	X		•					•	U
	BIP.	X	•						•	U
± 5 V	UNIP.	X		•					•	U
	BIP.	X		•					•	U
0 - 10 V	UNIP.	X		•					•	U
	BIP.	X	•						•	U
± 10 V	UNIP.	X		•					•	U
	BIP.	X		•					•	U
0 - 20 mA	UNIP.	X		•				X	•	I
	BIP.	X	•					X	•	I
± 20 mA	UNIP.	X		•				X	•	I
	BIP.	X		•				X	•	I
4 - 20 mA	UNIP.	X			•	•	X	•	•	I
	BIP.	X	•			•	•	X	•	I

• = ON
= OFF
X = ANY

CODE	XCAIPI03
TYPE	CAIPI03
INPUT TECHNICAL DATA	
Signal type IN	analogue
Input range IN	19 programmable ranges (see tab. 1)
Maximum voltage current signal IN	15 V / 30 A
Input impedance IN	1 MΩ (voltage input) / 50 Ω (current input)
Parametrization IN	DIP switch
OUTPUT TECHNICAL DATA	
Signal type OUT	analogue
Output range OUT	7 programmable steps (see tab. 2)
Maximum output signal OUT	12 V / 25 mA
Load impedance OUT	> 10 kΩ (voltage output) / ≤ 500 Ω (current output)
Ripple OUT	—
Status indication OUT	LED
Parametrization OUT	DIP switch
GENERAL TECHNICAL DATA	
Power supply voltage	24 Vdc (15...36 Vdc)
Current consumption	100 mA (24 Vdc)
Accuracy	0.1% FSR (23°C)
Linearity error	< 0.1% FS
Temperature coefficient	—
Setting time	—
Transmission frequency	400Hz...1kHz
Resolution	—
Rise time	—
Operating temperature range	-10...+65°C
Insulation	3.0 kVac / 60 s
Insulation type	3-way (IN / OUT1 / power)
Standard approvals	IEC 664-1, DIN VDE0110.1
EMC Standards	EN 50081-2, EN 50082-2
Overvoltage category / Pollution degree	II / 2
Protection degree	IP 20
Connection terminal IN / OUT	2.5 mm ² / 2.5 mm ² (screw)
Housing material	UL94V-0 plastic material
Dimensions	22.5x108x119 mm
Approximate weight	150 g
Mounting informations	vertical on a rail, distance 5 mm from adjacent components
APPROVALS	CE
ACCESSORIES	
Mounting rail (IEC60715/TH35-7.5)	PR/3/AC, PR/3/AC/ZB, PR/3/AS, PR/3/AS/ZB
Mounting rail (IEC60715/TH35-15)	—
Marking tag	—
Plugin jumper red	—
Plugin jumper white	—
Plugin jumper blue	—
Programming kit	—

INPUT STAGE

The module can manage single-pole and two-pole inputs selecting between steps (see TAB. 1):

- 0...60 mV ± 60 mV
- 0...100 mV ± 100 mV
- 0...500 mV ± 500 mV
- 0...1 V ± 1 V
- 0...5 V ± 5 V
- 0...10 V ± 10 V
- 0...5 mA ± 5 mA
- 0...10 mA ± 10 mA
- 0...20 mA ± 20 mA
- 4...20 mA

The input stage provides two power supplies (10 V and 24 V) for remote sensors. It is possible to run potentiometers and directly power 4...20 mA two-wire loop sensors.

Connection examples:

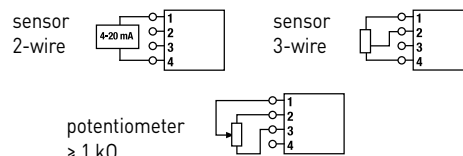

OUTPUT STAGE

The module provides single-pole and two-pole output signals with the following steps (see Tab. 2):

- 0...5 V ± 5 V
- 0...10 V ± 10 V
- 0...20 mA ± 20 mA
- 4...20 mA

- Input: 14 selectable ranges
- Output: 3 selectable ranges
- Insulation: 1.5 kVac, 3-way isolation

NOTE

(1) New model, available starting from November 2020

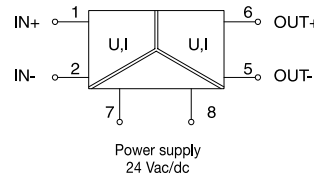
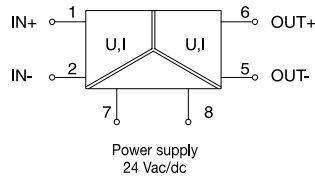

APPLICATIONS

Converts and galvanically isolates the main standardised analogue signals; input programmable with 14 signal ranges and output with the three most used standardised signals. Configuration is obtained by setting the DIP-switches on the side.

This module offers multiple in/out signal combinations, allowing for significant savings in terms of costs.

3-way galvanic separation ensures total isolation between input, output and power supply which, together with automatic signal calibration, ensures excellent precision without the need for calibration.

Where multiple output channels are needed for a single signal source, multiple converters may be used connecting the signal inputs in parallel, in the case of voltage signals, or in series, in the case of current signals.

CODE	X756516	XCONAA516P
TYPE	CWUAA 6-0516	CON-AA-516P (1)
INPUT TECHNICAL DATA		
Signal type IN	analogue	analogue
Input range IN	14 programmable ranges (see tab. 1)	14 programmable ranges (see tab. 1)
Maximum voltage current signal IN	—	—
Input impedance IN	330 kΩ (voltage input) / 100 Ω (current input)	330 kΩ (voltage input) / 100 Ω (current input)
Parametrization IN	DIP switch	DIP switch
OUTPUT TECHNICAL DATA		
Signal type OUT	analogue	analogue
Output range OUT	0...10 V / 0...20 mA / 4...20 mA	0...10 V / 0...20 mA / 4...20 mA
Maximum output signal OUT	21 mA (voltage input)	16 V (voltage output) / 5 mA (current output)
Load impedance OUT	>1 kΩ (voltage output) / <400 Ω (current output)	2 KΩ (voltage output) / 400 Ω (current output)
Ripple OUT	<5 mV	<20 mV
Status indication OUT	LED	LED
Parametrization OUT	DIP switch	DIP switch
GENERAL TECHNICAL DATA		
Power supply voltage	24 Vac/dc (16.8...30 Vdc / 19.2...28.8 Vac)	24 Vac/dc (19.2...26.4 Vdc / 19.2...26.4 Vac)
Current consumption	35 mA	—
Accuracy	0.1% FSR (23°C)	0.1% FSR (23°C)
Linearity error	0.02%	0.05% FSR
Temperature coefficient	<150 ppm / K FSR	<150 ppm / K FSR
Setting time	—	—
Transmission frequency	30 Hz	30 Hz 3dB
Resolution	—	—
Rise time	10 ms	6 ms
Operating temperature range	-25...+60°C	-25...+60°C
Insulation	1.5 kVac / 60 s	2.5 kVac / 60 s
Insulation type	3-way (IN / OUT1 / power)	3-way (IN / OUT1 / power)
Standard approvals	—	EN 60947-5-1
EMC Standards	—	—
Overvoltage category / Pollution degree	II / 2	II / 2
Protection degree	IP 20	IP 20
Connection terminal IN / OUT	2.5 mm ² / 2.5 mm ² (screw)	2.5 mm ² / 2.5 mm ² (push-in)
Housing material	UL94V-0 plastic material	UL94V-0 plastic material
Dimensions	17.5x79x84 mm	17.5x93x73 mm
Approximate weight	70 g	60 g
Mounting informations	on a rail, side by side	on a rail, side by side
APPROVALS		
ACCESSORIES		
Mounting rail (IEC60715/TH35-7.5)	PR/3/AC, PR/3/AC/ZB, PR/3/AS, PR/3/AS/ZB	PR/3/AC, PR/3/AC/ZB, PR/3/AS, PR/3/AS/ZB
Mounting rail (IEC60715/TH35-15)	—	—
Marking tag	TAP207A_	—
Plugin jumper red	—	—
Plugin jumper white	—	—
Plugin jumper blue	—	—
Programming kit	—	—

Tab. 1 - Input ranges

0...60 / 0...100 / 0...300 / 0...500 mV
0...1 / 0...2 / 0...5 / 0...10 / 0...20 / 2...20 V
0...5 / 0...10 / 0...20 / 4...20 / ±5 / ±20 mA

- Input: 3 selectable ranges
- Output: 3 selectable ranges
- Insulation: 1.5 kVac, 3-way isolation



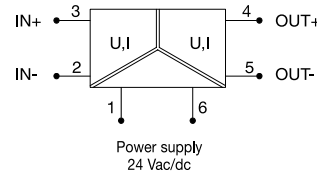
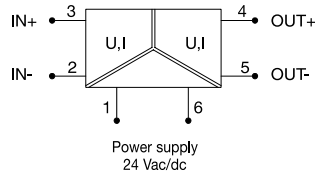

NOTE

(1) New model, available starting from November 2020



APPLICATIONS

Convert and galvanically isolate the main standardised analogue signals; input programmable with 3 signal ranges and output with the 3 most used standard signals. Configuration is obtained by setting the DIP-switches on the side. Programmable in the most used signal combinations, these cards allow for a significant cost saving over the more complex 14 range version. Where multiple output channels are needed for a single signal source, multiple converters may be used connecting the signal inputs in parallel (with voltage signals) or in series (with current signals).

CODE	X756539	XCONAA539P
TYPE	CWNAA-7-0539	CON-AA-539P (1)
INPUT TECHNICAL DATA		
Signal type IN	analogue	analogue
Input range IN	0...10 V / 0...20 mA / 4...20 mA	0...10 V / 0...20 mA / 4...20 mA
Maximum voltage current signal IN	—	—
Input impedance IN	330 kΩ (voltage input) / 100 Ω (current input)	330 kΩ (voltage input) / 100 Ω (current input)
Parametrization IN	DIP switch	DIP switch
OUTPUT TECHNICAL DATA		
Signal type OUT	analogue	analogue
Output range OUT	0...10 V / 0...20 mA / 4...20 mA	0...10 V / 0...20 mA / 4...20 mA
Maximum output signal OUT	21 mA (voltage input)	16 V (voltage output) / 5 mA (current output)
Load impedance OUT	>1 kΩ (voltage output) / <400 Ω (current output)	2 KΩ (voltage output) / 400 Ω (current output)
Ripple OUT	<5 mV	<20 mV
Status indication OUT	LED	LED
Parametrization OUT	DIP switch	DIP switch
GENERAL TECHNICAL DATA		
Power supply voltage	24 Vac/dc (16.8...30 Vdc / 19.2...28.8 Vac)	24 Vac/dc (19.2...26.4 Vdc / 19.2...26.4 Vac)
Current consumption	13 mA	—
Accuracy	0.1% FSR (23°C)	0.1% FSR (23°C)
Linearity error	0.1%	0.05% FSR
Temperature coefficient	<150 ppm / K FSR	<150 ppm / K FSR
Setting time	—	—
Transmission frequency	30 Hz	30 Hz
Resolution	—	—
Rise time	10 ms	6 ms
Operating temperature range	-25...+60°C	-25...+60°C
Insulation	1.5 kVac / 60 s	2.5 kVac / 60 s
Insulation type	3-way (IN / OUT1 / power)	3-way (IN / OUT1 / power)
Standard approvals	—	EN 60947-5-1
EMC Standards	—	—
Overvoltage category / Pollution degree	II / 2	II / 2
Protection degree	IP 20	IP 20
Connection terminal IN / OUT	1.5 mm ² / 1.5 mm ² (screw)	2.5 mm ² / 2.5 mm ² (push-in)
Housing material	UL94V-0 plastic material	UL94V-0 plastic material
Dimensions	6.2x90x92.5 mm	6.2x93x73 mm
Approximate weight	40 g	30g
Mounting informations	on a rail, side by side	on a rail, side by side
APPROVALS	 	 
ACCESSORIES		
Mounting rail (IEC60715/TH35-7.5)	PR/3/AC, PR/3/AC/ZB, PR/3/AS, PR/3/AS/ZB	PR/3/AC, PR/3/AC/ZB, PR/3/AS, PR/3/AS/ZB
Mounting rail (IEC60715/TH35-15)	—	—
Marking tag	—	—
Plugin jumper red	CWBK 7-0802 (code X766802)	—
Plugin jumper white	CWBK 7-0803 (code X766803)	—
Plugin jumper blue	CWBK 7-0804 (code X766804)	—
Programming kit	—	—

- Input: 0...10 V
- Output: 0...10 V / 0...20 mA / 4...20 mA
- Insulation: 1.5 kVac, 3-way isolation

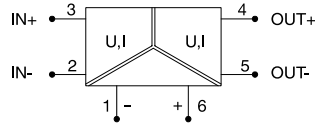

Power supply
24 Vac/dc

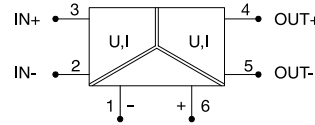

Power supply
24 Vac/dc

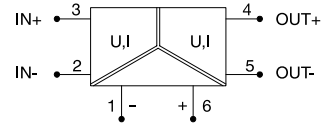

Power supply
24 Vac/dc

CODE	X756530	X756531	X756532
TYPE	CWAA 7-0530	CWAA 7-0531	CWAA 7-0532
INPUT TECHNICAL DATA			
Signal type IN	analogue	analogue	analogue
Input range IN	0...10 V	0...10 V	0...10 V
Maximum voltage current signal IN	—	—	—
Input impedance IN	330 kΩ	330 kΩ	330 kΩ
Parametrization IN	—	—	—
OUTPUT TECHNICAL DATA			
Signal type OUT	analogue	analogue	analogue
Output range OUT	0...10 V	0...20 mA	4...20 mA
Maximum output signal OUT	21 mA	—	—
Load impedance OUT	>1 kΩ	<400 Ω	<400 Ω
Ripple OUT	<5 mV	<5 mV	<5 mV
Status indication OUT	LED	LED	LED
Parametrization OUT	—	—	—
GENERAL TECHNICAL DATA			
Power supply voltage	24 Vac/dc (16.8...30 Vdc / 19.2...28.8 Vac)	24 Vac/dc (16.8...30 Vdc / 19.2...28.8 Vac)	24 Vac/dc (16.8...30 Vdc / 19.2...28.8 Vac)
Current consumption	13 mA	13 mA	13 mA
Accuracy	0.1% FSR (23°C)	0.1% FSR (23°C)	0.1% FSR (23°C)
Linearity error	0.1%	0.1%	0.1%
Temperature coefficient	<150 ppm / K FSR	<150 ppm / K FSR	<150 ppm / K FSR
Setting time	—	—	—
Transmission frequency	30 Hz	30 Hz	30 Hz
Resolution	—	—	—
Rise time	10 ms	10 ms	10 ms
Operating temperature range	-25...+60°C	-25...+60°C	-25...+60°C
Insulation	1.5 kVac / 60 s	1.5 kVac / 60 s	1.5 kVac / 60 s
Insulation type	3-way (IN / OUT1 / power)	3-way (IN / OUT1 / power)	3-way (IN / OUT1 / power)
Standard approvals	—	—	—
EMC Standards	—	—	—
Overvoltage category / Pollution degree	II / 2	II / 2	II / 2
Protection degree	IP 20	IP 20	IP 20
Connection terminal IN / OUT	1.5 mm ² / 1.5 mm ² (screw)	1.5 mm ² / 1.5 mm ² (screw)	1.5 mm ² / 1.5 mm ² (screw)
Housing material	UL94V-0 plastic material	UL94V-0 plastic material	UL94V-0 plastic material
Dimensions	6.2x90x92.2 mm	6.2x90x92.2 mm	6.2x90x92.2 mm
Approximate weight	40 g	40 g	40 g
Mounting informations	on a rail, side by side	on a rail, side by side	on a rail, side by side
APPROVALS			
ACCESSORIES			
Mounting rail (IEC60715/TH35-7.5)	PR/3/AC, PR/3/AC/ZB, PR/3/AS, PR/3/AS/ZB	PR/3/AC, PR/3/AC/ZB, PR/3/AS, PR/3/AS/ZB	PR/3/AC, PR/3/AC/ZB, PR/3/AS, PR/3/AS/ZB
Mounting rail (IEC60715/TH35-15)	—	—	—
Marking tag	—	—	—
Plugin jumper red	CWBK 7-0802 (code X766802)	CWBK 7-0802 (code X766802)	CWBK 7-0802 (code X766802)
Plugin jumper white	CWBK 7-0803 (code X766803)	CWBK 7-0803 (code X766803)	CWBK 7-0803 (code X766803)
Plugin jumper blue	CWBK 7-0804 (code X766804)	CWBK 7-0804 (code X766804)	CWBK 7-0804 (code X766804)
Programming kit	—	—	—

- Input: 0...20 mA
- Output: 0...10 V / 0...20 mA / 4...20 mA
- Insulation: 1.5 kVac, 3-way isolation

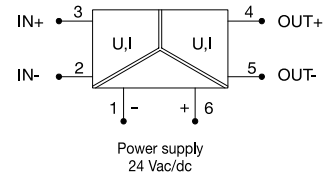
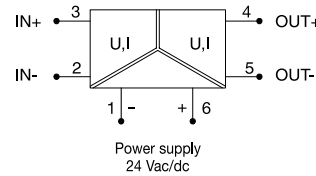
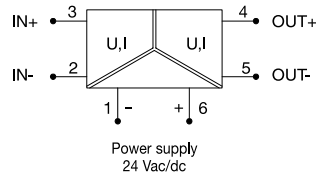

CODE	X756533	X756534	X756535
TYPE	CWAA 7-0533	CWAA 7-0534	CWAA 7-0535
INPUT TECHNICAL DATA			
Signal type IN	analogue	analogue	analogue
Input range IN	0...20 mA	0...20 mA	0...20 mA
Maximum voltage current signal IN	—	—	—
Input impedance IN	100 Ω	100 Ω	100 Ω
Parametrization IN	—	—	—
OUTPUT TECHNICAL DATA			
Signal type OUT	analogue	analogue	analogue
Output range OUT	0...10 V	0...20 mA	4...20 mA
Maximum output signal OUT	21 mA	—	—
Load impedance OUT	>1 kΩ	<400 Ω	<400 Ω
Ripple OUT	<5 mV	<5 mV	<5 mV
Status indication OUT	LED	LED	LED
Parametrization OUT	—	—	—
GENERAL TECHNICAL DATA			
Power supply voltage	24 Vac/dc (16.8...30 Vdc / 19.2...28.8 Vac)	24 Vac/dc (16.8...30 Vdc / 19.2...28.8 Vac)	24 Vac/dc (16.8...30 Vdc / 19.2...28.8 Vac)
Current consumption	13 mA	13 mA	13 mA
Accuracy	0.1% FSR (23°C)	0.1% FSR (23°C)	0.1% FSR (23°C)
Linearity error	0.1%	0.1%	0.1%
Temperature coefficient	<150 ppm / K FSR	<150 ppm / K FSR	<150 ppm / K FSR
Setting time	—	—	—
Transmission frequency	30 Hz	30 Hz	30 Hz
Resolution	—	—	—
Rise time	10 ms	10 ms	10 ms
Operating temperature range	-25...+60°C	-25...+60°C	-25...+60°C
Insulation	1.5 kVac / 60 s	1.5 kVac / 60 s	1.5 kVac / 60 s
Insulation type	3-way (IN / OUT1 / power)	3-way (IN / OUT1 / power)	3-way (IN / OUT1 / power)
Standard approvals	—	—	—
EMC Standards	—	—	—
Overvoltage category / Pollution degree	II / 2	II / 2	II / 2
Protection degree	IP 20	IP 20	IP 20
Connection terminal IN / OUT	1.5 mm ² / 1.5 mm ² (screw)	1.5 mm ² / 1.5 mm ² (screw)	1.5 mm ² / 1.5 mm ² (screw)
Housing material	UL94V-0 plastic material	UL94V-0 plastic material	UL94V-0 plastic material
Dimensions	6.2x90x92.2 mm	6.2x90x92.2 mm	6.2x90x92.2 mm
Approximate weight	40 g	40 g	40 g
Mounting informations	on a rail, side by side	on a rail, side by side	on a rail, side by side
APPROVALS			
ACCESSORIES			
Mounting rail (IEC60715/TH35-7.5)	PR/3/AC, PR/3/AC/ZB, PR/3/AS, PR/3/AS/ZB	PR/3/AC, PR/3/AC/ZB, PR/3/AS, PR/3/AS/ZB	PR/3/AC, PR/3/AC/ZB, PR/3/AS, PR/3/AS/ZB
Mounting rail (IEC60715/TH35-15)	—	—	—
Marking tag	—	—	—
Plugin jumper red	CWBK 7-0802 (code X766802)	CWBK 7-0802 (code X766802)	CWBK 7-0802 (code X766802)
Plugin jumper white	CWBK 7-0803 (code X766803)	CWBK 7-0803 (code X766803)	CWBK 7-0803 (code X766803)
Plugin jumper blue	CWBK 7-0804 (code X766804)	CWBK 7-0804 (code X766804)	CWBK 7-0804 (code X766804)
Programming kit	—	—	—

CONVERTERS

- Input: 4...20 mA
- Output: 0...10 V / 0..20 mA / 4...20 mA
- Insulation: 1.5 kVac, 3-way isolation

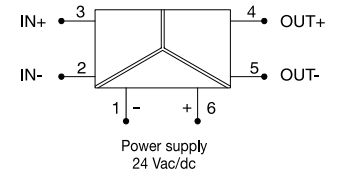
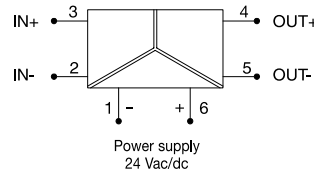
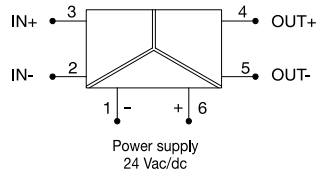

CODE	X756536	X756537	X756538
TYPE	CWAA 7-0536	CWAA 7-0537	CWAA 7-0538
INPUT TECHNICAL DATA			
Signal type IN	analogue	analogue	analogue
Input range IN	4...20 mA	4...20 mA	4...20 mA
Maximum voltage current signal IN	—	—	—
Input impedance IN	100 Ω	100 Ω	100 Ω
Parametrization IN	—	—	—
OUTPUT TECHNICAL DATA			
Signal type OUT	analogue	analogue	analogue
Output range OUT	0...10 V	0..20 mA	4...20 mA
Maximum output signal OUT	21 mA	—	—
Load impedance OUT	>1 kΩ	<400 Ω	<400 Ω
Ripple OUT	<5 mV	<5 mV	<5 mV
Status indication OUT	LED	LED	LED
Parametrization OUT	—	—	—
GENERAL TECHNICAL DATA			
Power supply voltage	24 Vac/dc (16.8...30 Vdc / 19.2...28.8 Vac)	24 Vac/dc (16.8...30 Vdc / 19.2...28.8 Vac)	24 Vac/dc (16.8...30 Vdc / 19.2...28.8 Vac)
Current consumption	13 mA	13 mA	13 mA
Accuracy	0.1% FSR (23°C)	0.1% FSR (23°C)	0.1% FSR (23°C)
Linearity error	0.1%	0.1%	0.1%
Temperature coefficient	<150 ppm / K FSR	<150 ppm / K FSR	<150 ppm / K FSR
Setting time	—	—	—
Transmission frequency	30 Hz	30 Hz	30 Hz
Resolution	—	—	—
Rise time	10 ms	10 ms	10 ms
Operating temperature range	-25...+60°C	-25...+60°C	-25...+60°C
Insulation	1.5 kVac / 60 s	1.5 kVac / 60 s	1.5 kVac / 60 s
Insulation type	3-way (IN / OUT1 / power)	3-way (IN / OUT1 / power)	3-way (IN / OUT1 / power)
Standard approvals	—	—	—
EMC Standards	—	—	—
Overvoltage category / Pollution degree	II / 2	II / 2	II / 2
Protection degree	IP 20	IP 20	IP 20
Connection terminal IN / OUT	1.5 mm ² / 1.5 mm ² (screw)	1.5 mm ² / 1.5 mm ² (screw)	1.5 mm ² / 1.5 mm ² (screw)
Housing material	UL94V-0 plastic material	UL94V-0 plastic material	UL94V-0 plastic material
Dimensions	6.2x90x92.2 mm	6.2x90x92.2 mm	6.2x90x92.2 mm
Approximate weight	40 g	40 g	40 g
Mounting informations	on a rail, side by side	on a rail, side by side	on a rail, side by side
APPROVALS			
ACCESSORIES			
Mounting rail (IEC60715/TH35-7.5)	PR/3/AC, PR/3/AC/ZB, PR/3/AS, PR/3/AS/ZB	PR/3/AC, PR/3/AC/ZB, PR/3/AS, PR/3/AS/ZB	PR/3/AC, PR/3/AC/ZB, PR/3/AS, PR/3/AS/ZB
Mounting rail (IEC60715/TH35-15)	—	—	—
Marking tag	—	—	—
Plugin jumper red	CWBK 7-0802 (code X766802)	CWBK 7-0802 (code X766802)	CWBK 7-0802 (code X766802)
Plugin jumper white	CWBK 7-0803 (code X766803)	CWBK 7-0803 (code X766803)	CWBK 7-0803 (code X766803)
Plugin jumper blue	CWBK 7-0804 (code X766804)	CWBK 7-0804 (code X766804)	CWBK 7-0804 (code X766804)
Programming kit	—	—	—

- Input: 4...20 mA
- Output: 4...20 mA
- Insulation: 1.5 kVac, 2-way isolation
- Suitable for loop powered sensors



NOTE

(1) In order to ensure an output current of 20 mA, the input voltage must have a value higher than that resulting from the formula, where R_b is the resistance of the applied load (see figure 1), for greater ease we report the voltage graph minimum input according to the load variation applied at the outlet (see figure 2).

(2) New model, available starting from November 2020

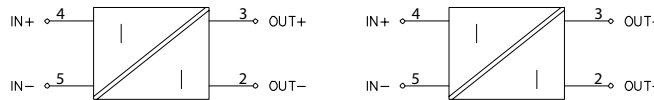

APPLICATIONS

Passive galvanic isolators are used to separate signals generated by active (i.e. powered) sensors, and are also referred to as current loop or loop powered. The load applied to them must have a resistance of below 400 Ω at 20 mA, including the resistance of the conductors.

The input voltage delivered must be 2.7 V higher than the output voltage (see note 1).

When these use conditions are met, passive converters are able to reduce wiring costs for power supply cables and prevent the need for external power supplies; they are not suitable for long connection wiring since they can heavily influence the output signal level.

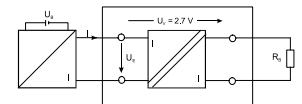

fig. 1

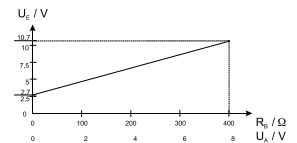
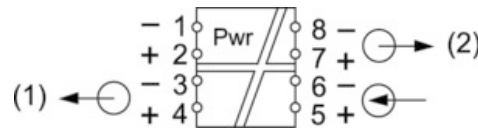

fig. 2

CODE	X756526	XCONPC528P
TYPE	CWPA 7-0526	CON-PC-528P (2)
INPUT TECHNICAL DATA		
Signal type IN	analogue	analogue
Input range IN	0...20 mA, 4...20 mA	4...20 mA
Maximum voltage current signal IN	$[20 \text{ mA} \times R_b] + 2.7$ (1)	—
Input impedance IN	1 k Ω	—
Parametrization IN	—	—
OUTPUT TECHNICAL DATA		
Signal type OUT	analogue	analogue
Output range OUT	0...20 / 4...20 mA, (max 21 mA)	4...20 mA
Maximum output signal OUT	21 mA	—
Load impedance OUT	—	<1 k Ω (R_b)
Ripple OUT	<5 mV	<5 mV
Status indication OUT	—	LED
Parametrization OUT	—	—
GENERAL TECHNICAL DATA		
Power supply voltage	—	—
Current consumption	—	—
Accuracy	0.1% FSR (23°C)	0.1% FSR (23°C)
Linearity error	—	<0.06% (100 Ω)
Temperature coefficient	<150 ppm / K FSR	<150 ppm / K FSR
Setting time	—	—
Transmission frequency	—	—
Resolution	—	—
Rise time	6 ms	—
Operating temperature range	-25...+60°C	-25...+60°C
Insulation	1.5 kVac / 60 s	1.5 kVac / 60 s
Insulation type	2-way (IN / OUT)	2-way (IN / OUT)
Standard approvals	—	EN 60947-5-1
EMC Standards	—	—
Overvoltage category / Pollution degree	II / 2	II / 2
Protection degree	IP 20	IP 20
Connection terminal IN / OUT	1.5 mm ² / 1.5 mm ² (screw)	2.5 mm ² / 2.5 mm ² (push-in)
Housing material	UL94V-0 plastic material	UL94V-0 plastic material
Dimensions	6.2x90x92.5 mm	6.2x93x73 mm
Approximate weight	35 g	40 g
Mounting informations	on a rail, side by side	on a rail, side by side
APPROVALS		
ACCESSORIES		
Mounting rail (IEC60715/TH35-7.5)	PR/3/AC, PR/3/AC/ZB, PR/3/AS, PR/3/AS/ZB	—
Mounting rail (IEC60715/TH35-15)	—	PR/3/AC, PR/3/AC/ZB, PR/3/AS, PR/3/AS/ZB
Marking tag	—	—
Plugin jumper red	CWBK 7-0802 (code X766802)	—
Plugin jumper white	CWBK 7-0803 (code X766803)	—
Plugin jumper blue	CWBK 7-0804 (code X766804)	—
Programming kit	—	—

- Input: 3 selectable ranges
- Output: 3 selectable ranges
- Insulation: 2.5 kVac, 4-way isolation



Programming kit X756894

CODE	X756321
TYPE	LCON AASP
INPUT TECHNICAL DATA	
Signal type IN	analogue
Input range IN	0...10 V / 0...20 mA / 4...20 mA
Maximum voltage current signal IN	—
Input impedance IN	500 KΩ (voltage input) / 100 Ω (current input)
Parametrization IN	DIP switch
OUTPUT TECHNICAL DATA	
Signal type OUT	double output, analogue
Output range OUT	0...10 V / 0...20 mA / 4...20 mA
Maximum output signal OUT	10.5 V (voltage output) / 21 mA (current output)
Load impedance OUT	2 KΩ (voltage output) / 400 Ω (current output)
Ripple OUT	<20 mV
Status indication OUT	LED
Parametrization OUT	DIP switch
GENERAL TECHNICAL DATA	
Power supply voltage	24 Vdc (16.8...30 Vdc)
Current consumption	13 mA
Accuracy	0.1% FSR (23°C)
Linearity error	±0.1% FSR
Temperature coefficient	<150 ppm / K FSR
Setting time	—
Transmission frequency	—
Resolution	16 bit
Rise time	—
Operating temperature range	-40...+70°C
Insulation	2.5 kVac / 60 s
Insulation type	4-way (IN / OUT1 / OUT2 / power)
Standard approvals	EN 60947-5-1
EMC Standards	EN 61000-6-2, EN 61000-6-4
Overvoltage category / Pollution degree	II / 2
Protection degree	IP 20
Connection terminal IN / OUT	1.5 mm ² / 1.5 mm ² (screw)
Housing material	UL94V-0 plastic material
Dimensions	6.2x90x115.5 mm
Approximate weight	60 g
Mounting informations	on a rail, side by side
APPROVALS	CE
ACCESSORIES	
Mounting rail (IEC60715/TH35-7.5)	PR/3/AC, PR/3/AC/ZB, PR/3/AS, PR/3/AS/ZB
Mounting rail (IEC60715/TH35-15)	—
Marking tag	—
Plugin jumper red	CWBK 7-0802 (code X766802)
Plugin jumper white	CWBK 7-0803 (code X766803)
Plugin jumper blue	CWBK 7-0804 (code X766804)
Programming kit	—

APPLICATIONS

LCONAASP is a programmable 4-way isolated converter, it allows to convert, amplify and duplicate a standard analog signal. Input can be set to the standard analog signals 0 ... 20 mA, 4 ... 20 mA and 0 ... 10 V, the signal is isolated, converted and duplicated into two independent signals that can be set to 0 ... 20 mA, 4 ... 20 mA and 0 ... 10 V. The ranges can be set easily through a DIP switch

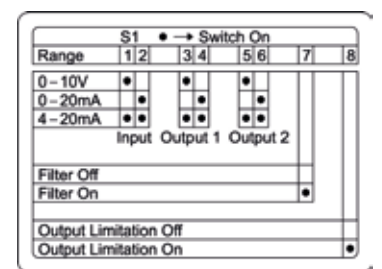
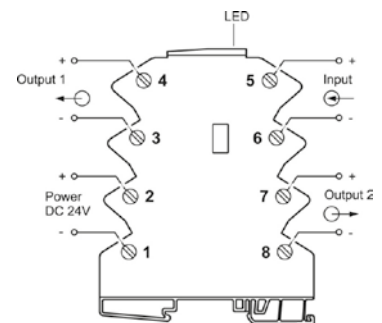

See instruction leaflet for details

- Input: PT100, PT1000, thermocouples, potentiometers
- Output: 4 selectable ranges
- Insulation: 2.5 kVac, 3-way isolation
- DIP-switch and FDT/DTM software programmable ranges

NOTE

(1) Input and output signal range, can be customised using FDT/DTM software and LCONZUSB interface

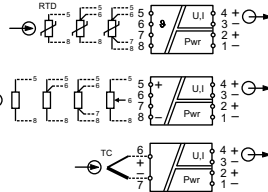

Programming kit X756894

CODE	X756340
TYPE	LCONTAD
INPUT TECHNICAL DATA	
Signal type IN	PT100, PT1000, potentiometer 0...600kΩ, thermocouples [B, C, E, J, K, N, R, S, T]
Input range IN	-200...+2400°C, based on sensor
Maximum voltage current signal IN	—
Input impedance IN	—
Parametrization IN	DIP switch, FDT/DTM software (1)
OUTPUT TECHNICAL DATA	
Signal type OUT	analogue
Output range OUT	0...10 V / 0...20 mA / 4...20 mA
Maximum output signal OUT	10.5 V (voltage output) / 21 mA (current output)
Load impedance OUT	>2 kΩ (voltage output) / <700 Ω (current output)
Ripple OUT	—
Status indication OUT	LED
Parametrization OUT	DIP switch, FDT/DTM software (1)
GENERAL TECHNICAL DATA	
Power supply voltage	24 Vdc (16.8...30 Vdc)
Current consumption	18 mA
Accuracy	0.2% FSR (for PT) / 0.4% FSR (for TC)
Linearity error	±0.1% FSR
Temperature coefficient	<100 ppm / K FSR
Setting time	5...500 ms (adjustable, default 30 ms)
Transmission frequency	—
Resolution	16 bit
Rise time	—
Operating temperature range	-40...+70°C
Insulation	2.5 kVac / 60 s
Insulation type	3-way (IN / OUT1 / power)
Standard approvals	—
EMC Standards	—
Overvoltage category / Pollution degree	II / 2
Protection degree	IP 20
Connection terminal IN / OUT	1.5 mm ² / 1.5 mm ² (screw)
Housing material	UL94V-0 plastic material
Dimensions	6.2x90x115.5 mm
Approximate weight	40 g
Mounting informations	on a rail, side by side
APPROVALS	CE
ACCESSORIES	
Mounting rail (IEC60715/TH35-7.5)	PR/3/AC, PR/3/AC/ZB, PR/3/AS, PR/3/AS/ZB
Mounting rail (IEC60715/TH35-15)	—
Marking tag	—
Plugin jumper red	CWBK 7-0802 (code X766802)
Plugin jumper white	CWBK 7-0803 (code X766803)
Plugin jumper blue	CWBK 7-0804 (code X766804)
Programming kit	LCONZUSB (code X756894)

APPLICATIONS

CWTPR 7-0360 is a "universal" converter for a wide range of analogue signals that can be used with the most popular models of analogue sensors on the market. Both input ranges and output thresholds can be changed using FDT/DTM software and a USB interface. The normally open contacts of the two output thresholds are managed by two solid state relays.

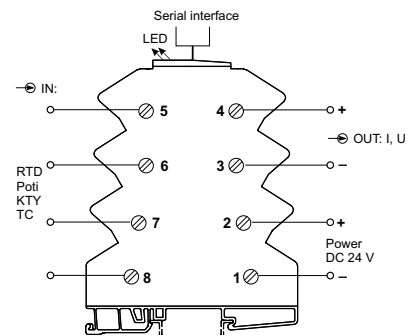

Range*	S1	S2				
Start	[7][8]	[1][2]	End	[3][4]	[5][6]	[7][8]
-200°C	•	•	0°C	•	•	
-150°C	•	•	50°C	•	•	
-100°C	•	•	100°C	•	•	
-50°C	•	•	150°C	•	•	
0°C	•	•	200°C	•	•	
Sensor*	S1	[1][2][3]	250°C	•	•	
			300°C	•	•	
Pt100	•	•	350°C	•	•	
Pt1000	•	•	400°C	•	•	
TE J	•	•	450°C	•	•	
TE K	•	•	500°C	•	•	
R	•	•	550°C	•	•	
Output*	S1	[4][5][6]	600°C	•	•	
			650°C	•	•	
0-20mA	•	•	700°C	•	•	
4-20mA	•	•	750°C	•	•	
0-10V	•	•	800°C	•	•	
±10V	•	•	850°C	•	•	
S1-S2 1-8 off:			900°C	•	•	
FDT/DTM			950°C	•	•	
			1000°C	•	•	
			1050°C	•	•	
			1100°C	•	•	
			1150°C	•	•	
			1200°C	•	•	
			1250°C	•	•	
			1300°C	•	•	
			1350°C	•	•	
			1400°C	•	•	
			1400°C	•	•	
			→ Switch On			

- Input: PT100 2/3-wire
- Output: 3 selectable ranges
- Insulation: 4 kVac, 3-way isolation

NOTE

- (1) May also be used with the 2-wire PT100, connecting terminal blocks 1 and 4 together
 (2) New model, available starting from November 2020

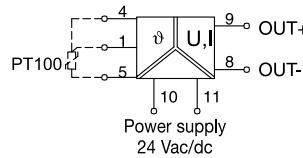
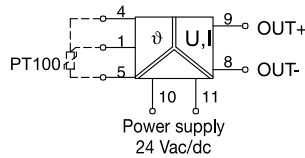

APPLICATIONS

The module converts and isolates signals deriving from three-wire PT100 (RTD) sensors into a proportional analogue signal and is programmable in 8 input temperature ranges and into the three main standard output signals. Configuration is obtained by setting the DIP-switches located on the side. The converters are galvanically isolated, which ensures more precise signal reading, and can be used both with isolated and non-isolated sensors. Two-wire sensors can be used by connecting terminal blocks 4 and 1 together.

CODE	X756816	XCONTA819P
TYPE	CWPT 6-0816	CON-TA-819P (2)
INPUT TECHNICAL DATA		
Signal type IN	PT100 2/3-wire (1)	PT100 2/3-wire (1)
Input range IN	8 programmable ranges (see tab. 1)	8 programmable ranges (see tab. 1)
Maximum voltage current signal IN	—	—
Input impedance IN	—	>1 MΩ (2-wire) / >500 kΩ (3-wire)
Parametrization IN	DIP switch	DIP switch
OUTPUT TECHNICAL DATA		
Signal type OUT	analogue	analogue
Output range OUT	0...10 V / 0...20 mA / 4...20 mA	0...10 V / 0...20 mA / 4...20 mA
Maximum output signal OUT	21 mA (voltage input)	16 V (voltage output) / 5 mA (current output)
Load impedance OUT	>1 kΩ (voltage output) / <400 Ω (current output)	>2 kΩ (voltage output) / <500 Ω (current output)
Ripple OUT	<5 mV	<20 mV
Status indication OUT	LED	LED
Parametrization OUT	DIP switch	DIP switch
GENERAL TECHNICAL DATA		
Power supply voltage	24 Vac/dc (16.8...30 Vdc / 19.2...28.8 Vac)	24 Vac/dc (18.0...31.2 Vdc / 19.2...26.4 Vac)
Current consumption	10 mA	13 mA (24 Vdc) / 22 mA (24 Vac)
Accuracy	0.3% FSR (23°C)	0.3% FSR (23°C)
Linearity error	0.1% FSR	0.1% FSR
Temperature coefficient	<150 ppm / K FSR	<150 ppm / K FSR
Setting time	5...500 ms (adjustable, default 30 ms)	—
Transmission frequency	10 Hz	10 Hz 3dB
Resolution	—	—
Rise time	30 ms	—
Operating temperature range	-25...+60°C	-25...+60°C
Insulation	4 kVac / 60 s	2.5 kVac / 60 s
Insulation type	3-way (IN / OUT1 / power)	3-way (IN / OUT1 / power)
Standard approvals	EN 60721-3-3, EN 50178	EN 60947-5-1
EMC Standards	EN 55011, EN 61000-4-2/6	—
Overvoltage category / Pollution degree	II / 2	II / 2
Protection degree	IP 20	IP 20
Connection terminal IN / OUT	2.5 mm ² / 2.5 mm ² (screw)	2.5 mm ² / 2.5 mm ² (push-in)
Housing material	UL94V-0 plastic material	UL94V-0 plastic material
Dimensions	17.5x79x84 mm	17.5x93x73 mm
Approximate weight	70 g	30 g
Mounting informations	on a rail, side by side	on a rail, side by side
APPROVALS		
ACCESSORIES		
Mounting rail (IEC60715/TH35-7.5)	PR/3/AC, PR/3/AC/ZB, PR/3/AS, PR/3/AS/ZB	PR/3/AC, PR/3/AC/ZB, PR/3/AS, PR/3/AS/ZB
Mounting rail (IEC60715/TH35-15)	—	—
Marking tag	TAP207A_	—
Plugin jumper red	—	—
Plugin jumper white	—	—
Plugin jumper blue	—	—
Programming kit	—	—

Tab. 1 - Input temperature ranges

- 50...+50°C (-58...+122°F)
- 50...+100°C (-58...+212°F)
- 50...+150°C (-58...+302°F)
- 0...+100°C (+32...+212°F)
- 0...+150°C (+32...+302°F)
- 0...+200°C (+32...+392°F)
- 0...+300°C (+32...+572°F)
- 0...+400°C (+32...+752°F)

- Input: thermocouple (J / K)
- Output: 3 selectable ranges
- Insulation: 4.0 kVac, 3-way isolation

NOTE
(1) New model, available starting from November 2020

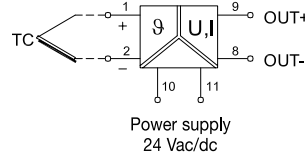
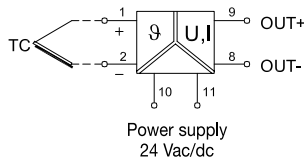

APPLICATIONS

The module converts and isolates signals deriving from type J (FeCuNi) or K (NiCr-Ni) thermocouples into a proportional analogue signal and is programmable in eight input temperature ranges and into the three main standard output signals. Configuration is obtained by setting the DIP-switches located on the side. The converters are galvanically isolated, which ensures more precise signal reading, and can be used both with isolated and non-isolated thermocouples.

CODE	X756844	XCONTA839P
TYPE	CWTH 6-0844	CON-TA-839P (1)
INPUT TECHNICAL DATA		
Signal type IN	thermocouple (J / K)	thermocouple (J / K)
Input range IN	8 programmable ranges (see tab. 1)	8 programmable ranges (see tab. 1)
Maximum voltage current signal IN	—	—
Input impedance IN	—	>1 MΩ
Parametrization IN	DIP switch	DIP switch
OUTPUT TECHNICAL DATA		
Signal type OUT	analogue	analogue
Output range OUT	0...10 V / 0...20 mA / 4...20 mA	0...10 V / 0...20 mA / 4...20 mA
Maximum output signal OUT	21 mA (voltage input)	16 V (voltage output) / 5 mA (current output)
Load impedance OUT	>1 kΩ (voltage output) / <400 Ω (current output)	>2 kΩ (voltage output) / <500 Ω (current output)
Ripple OUT	<5 mV	<20 mV
Status indication OUT	LED	LED
Parametrization OUT	DIP switch	DIP switch
GENERAL TECHNICAL DATA		
Power supply voltage	24 Vac/dc (16.8...30 Vdc / 19.2...28.8 Vac)	24 Vac/dc (18.0...31.2 Vdc / 19.2...26.4 Vac)
Current consumption	10 mA	—
Accuracy	0.5% FSR	0.5% + 2K FSR (23°C)
Linearity error	0.1% FSR	0.1% FSR
Temperature coefficient	<150 ppm / K FSR	<150 ppm / K FSR
Setting time	—	—
Transmission frequency	10 Hz	10 Hz
Resolution	—	—
Rise time	30 ms	—
Operating temperature range	-25...+60°C	-25...+60°C
Insulation	4 kVac / 60 s	2.5 kVac / 60 s
Insulation type	3-way (IN / OUT1 / power)	3-way (IN / OUT1 / power)
Standard approvals	IEC 664-1, DIN VDE	EN 60947-5-1
EMC Standards	EN 50081-2, EN 50082-2	—
Overvoltage category / Pollution degree	II / 2	II / 2
Protection degree	IP 20	IP 20
Connection terminal IN / OUT	2.5 mm ² / 2.5 mm ² (screw)	2.5 mm ² / 2.5 mm ² (push-in)
Housing material	UL94V-0 plastic material	UL94V-0 plastic material
Dimensions	17.5x79x84 mm	6.2x93x73 mm
Approximate weight	70 g	30 g
Mounting informations	on a rail, side by side	on a rail, side by side
APPROVALS		
ACCESSORIES		
Mounting rail (IEC60715/TH35-7.5)	PR/3/AC, PR/3/AC/ZB, PR/3/AS, PR/3/AS/ZB	
Mounting rail (IEC60715/TH35-15)	—	PR/3/AC, PR/3/AC/ZB, PR/3/AS, PR/3/AS/ZB
Marking tag	TAP207A_	—
Plugin jumper red	—	—
Plugin jumper white	—	—
Plugin jumper blue	—	—
Programming kit	—	—

Tab. 1 - Input temperature ranges

- 50...+200°C (-58...+392°F)
- 50...+350°C (-58 ...+662°F)
- 0...+200°C (+32...+392°F)
- 0...+400°C (+32...+752°F)
- 0...+600°C (+32...+1112°F)
- 0...+800°C (+32...+1472°F)
- 0...+1000°C (+32...+1832°F)
- 0...+1200°C (+32...+2192°F)

CONVERTERS

- Input: 0...1 A AC/DC
- Output: 3 selectable ranges
- Insulation: 2.5 kVac, 3-way isolation



NOTE

(1) Do not connect directly to a 400 V line

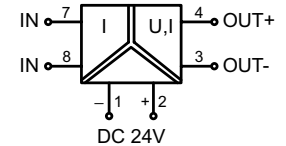
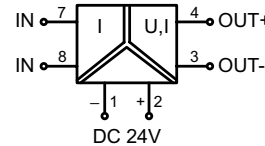
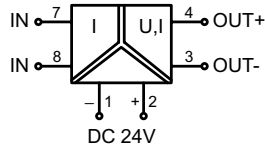

CODE	X756540	X756541	X756542
TYPE	WAA 7-0540	WAA 7-0541	WAA 7-0542
INPUT TECHNICAL DATA			
Signal type IN	current	current	current
Input range IN	0...1 A AC/DC	0...5 A AC/DC	0...10 A AC/DC
Maximum voltage current signal IN	400 V (1)	400 V (1)	400 V (1)
Input impedance IN	0.06 Ω	0.02 Ω	0.01 Ω
Parametrization IN	DIP switch	DIP switch	DIP switch
OUTPUT TECHNICAL DATA			
Signal type OUT	analogue	analogue	analogue
Output range OUT	0...10 V / 0...20 mA / 4...20 mA	0...10 V / 0...20 mA / 4...20 mA	0...10 V / 0...20 mA / 4...20 mA
Maximum output signal OUT	21 mA (voltage input)	21 mA (voltage input)	21 mA (voltage input)
Load impedance OUT	>1 kΩ (voltage output) / <400 Ω (current output)	>1 kΩ (voltage output) / <400 Ω (current output)	>1 kΩ (voltage output) / <400 Ω (current output)
Ripple OUT	<5 mV	<5 mV	<5 mV
Status indication OUT	LED	LED	LED
Parametrization OUT	DIP switch	DIP switch	DIP switch
GENERAL TECHNICAL DATA			
Power supply voltage	24 Vdc (16.8...30 Vdc)	24 Vdc (16.8...30 Vdc)	24 Vdc (16.8...30 Vdc)
Current consumption	13 mA	13 mA	13 mA
Accuracy	0.1% FSR (23°C)	0.1% FSR (23°C)	0.1% FSR (23°C)
Linearity error	0.5% FSR (23°C)	0.5% FSR (23°C)	0.5% FSR (23°C)
Temperature coefficient	<150 ppm / K FSR	<150 ppm / K FSR	<150 ppm / K FSR
Setting time	—	—	—
Transmission frequency	—	—	—
Resolution	—	—	—
Rise time	—	—	—
Operating temperature range	-25...+60°C	-25...+60°C	-25...+60°C
Insulation	2.5 kVac / 60 s	2.5 kVac / 60 s	2.5 kVac / 60 s
Insulation type	3-way (IN / OUT1 / power)	3-way (IN / OUT1 / power)	3-way (IN / OUT1 / power)
Standard approvals	—	—	—
EMC Standards	—	—	—
Overvoltage category / Pollution degree	II / 2	II / 2	II / 2
Protection degree	IP 20	IP 20	IP 20
Connection terminal IN / OUT	1.5 mm ² / 1.5 mm ² (screw)	1.5 mm ² / 1.5 mm ² (screw)	1.5 mm ² / 1.5 mm ² (screw)
Housing material	UL94V-0 plastic material	UL94V-0 plastic material	UL94V-0 plastic material
Dimensions	6.2x90x115.5 mm	6.2x90x115.5 mm	6.2x90x115.5 mm
Approximate weight	55 g	55 g	55 g
Mounting informations	on a rail, side by side	on a rail, side by side	on a rail, side by side
APPROVALS			
ACCESSORIES			
Mounting rail (IEC60715/TH35-7.5)	PR/3/AC, PR/3/AC/ZB, PR/3/AS, PR/3/AS/ZB	PR/3/AC, PR/3/AC/ZB, PR/3/AS, PR/3/AS/ZB	PR/3/AC, PR/3/AC/ZB, PR/3/AS, PR/3/AS/ZB
Mounting rail (IEC60715/TH35-15)	—	—	—
Marking tag	—	—	—
Plugin jumper red	CWBK 7-0802 (code X766802)	CWBK 7-0802 (code X766802)	CWBK 7-0802 (code X766802)
Plugin jumper white	CWBK 7-0803 (code X766803)	CWBK 7-0803 (code X766803)	CWBK 7-0803 (code X766803)
Plugin jumper blue	CWBK 7-0804 (code X766804)	CWBK 7-0804 (code X766804)	CWBK 7-0804 (code X766804)
Programming kit	—	—	—

- Input: 21 selectable ranges of frequency signal
- Output: 3 selectable ranges
- Insulation: 2.5 kVac, 3-way isolation

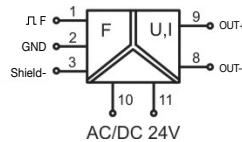

APPLICATIONS

This module is used to convert a sinusoid or rectangular frequency signal into a standard analogue signal (e.g. 0...10 V, 0...20 mA or 4...20 mA). A microprocessor detects the signal and calculates the output value, ensuring extremely high precision and stability. Measurement range is set using a DIP switch: the device offers 64 calibrated ranges from 0...100 Hz to 0...28.8 kHz.

CONVERTERS

CODE	X756524
TYPE	CWNFA 6-0524
INPUT TECHNICAL DATA	
Signal type IN	frequency
Input range IN	0...28.8 kHz (AC/DC 0.8...30 Vpp)
Maximum voltage current signal IN	—
Input impedance IN	50 kΩ
Parametrization IN	DIP switch
OUTPUT TECHNICAL DATA	
Signal type OUT	analogue
Output range OUT	0...10 V, (max. 10.6 V)
Maximum output signal OUT	0...20 / 4...20 mA, (max 21 mA)
Load impedance OUT	21 mA (voltage input)
Ripple OUT	1 kΩ (voltage output) / 400 Ω (current output)
Status indication OUT	<5 mV
Parametrization OUT	LED
GENERAL TECHNICAL DATA	DIP switch
Power supply voltage	
Current consumption	24 Vac/dc (16.8...30 Vdc / 19.2...28.8 Vac)
Accuracy	20 mA
Linearity error	0.1% FSR (23°C)
Temperature coefficient	0.02%
Setting time	<70 ppm/K
Transmission frequency	200 ms
Resolution	—
Rise time	—
Operating temperature range	—
Insulation	-25...+60°C
Insulation type	2.5 kVac / 60 s
Standard approvals	3-way (IN / OUT1 / power)
EMC Standards	—
Overvoltage category / Pollution degree	—
Protection degree	II / 2
Connection terminal IN / OUT	IP 20
Housing material	2.5 mm ² / 2.5 mm ² (screw)
Dimensions	UL94V-0 plastic material
Approximate weight	17.5x79x84 mm
Mounting informations	70 g
APPROVALS	on a rail, side by side
ACCESSORIES	
Mounting rail (IEC60715/TH35-7.5)	
Mounting rail (IEC60715/TH35-15)	PR/3/AC, PR/3/AC/ZB, PR/3/AS, PR/3/AS/ZB
Marking tag	—
Plugin jumper red	TAP207A_
Plugin jumper white	—
Plugin jumper blue	—
Programming kit	—

S2 ● → Switch On														
Range*	1	2	3	4	5	6	8	Range*	1	2	3	4	5	6
0 – 100Hz	●	●	●	●	●	●	●	0 – 5kHz	●	●	●	●	●	●
0 – 200Hz	●	●	●	●	●	●	●	0 – 6kHz	●	●	●	●	●	●
0 – 250Hz	●	●	●	●	●	●	●	0 – 8kHz	●	●	●	●	●	●
0 – 400Hz	●	●	●	●	●	●	●	0 – 10kHz	●	●	●	●	●	●
0 – 500Hz	●	●	●	●	●	●	●	0 – 12kHz	●	●	●	●	●	●
0 – 750Hz	●	●	●	●	●	●	●	0 – 16kHz	●	●	●	●	●	●
0 – 1kHz	●	●	●	●	●	●	●	0 – 20kHz	●	●	●	●	●	●
0 – 1.5kHz	●	●	●	●	●	●	●	0 – 24kHz	●	●	●	●	●	●
0 – 2kHz	●	●	●	●	●	●	●	0 – 28.8kHz	●	●	●	●	●	●
0 – 2.5kHz	●	●	●	●	●	●	●							
0 – 3kHz	●	●	●	●	●	●	●							
0 – 4kHz	●	●	●	●	●	●	●							
Hysteresis	0.5Vpp						5Vpp							

● → Switch On		
Output	S1	S2
0-10V	●	●
0-20mA	●	●
4-20mA	●	●

- Input: 3 selectable ranges
- Output: 2 semiconductor NO contacts
- Insulation: 2.5 kVac, 2-way isolation
- FDT/DTM software programmable ranges

NOTE

[1] Input and output signal range, can be customised using FDT/DTM software and LCONZUSB interface



Programming kit X756894

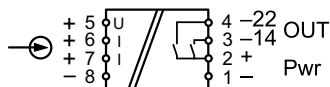

CODE	X756360
TYPE	LCONALS
INPUT TECHNICAL DATA	
Signal type IN	analogue
Input range IN	-30...+30 V / -50...+50 mA / -5...+5 A
Maximum voltage current signal IN	—
Input impedance IN	800 KΩ (voltage input) / 00.1-10 Ω (current input)
Hysteresis	—
Parametrization IN	FDT/DTM software [1]
OUTPUT TECHNICAL DATA	
Signal type OUT	2 NA contacts (solid state relay)
Output range OUT	30 Vdc / 100 mA
Status indication OUT	LED
Operating mode OUT	limit value, window, trend, inversion and memory
Parametrization OUT	FDT/DTM software [1]
GENERAL TECHNICAL DATA	
Power supply voltage	24 Vdc (16.8...30 Vdc)
Current consumption	12 mA
Auxiliary output voltage	—
Accuracy	0.1% FSR (voltage output) / 0.5% FSR (voltage output)
Linearity error	0.05% FSR (voltage output) / 0.1% FSR (voltage output)
Temperature coefficient	<100 ppm FSR
Setting time	1...500 ms (adjustable, default 30ms)
Transmission frequency	—
Resolution	16 bit
Rise time	—
Operating temperature range	-40...+70°C
Insulation	2.5 kVac / 60 s
Insulation type	2-way (IN / OUT)
Standard approvals	—
EMC Standards	—
Overvoltage category / Pollution degree	II / 2
Protection degree	IP 20
Connection terminal IN / OUT	1.5 mm ² / 1.5 mm ² (screw)
Housing material	UL94V-0 plastic material
Dimensions	6.2x90x115.5 mm
Approximate weight	50 g
Mounting information	on a rail, side by side
APPROVALS	CE
ACCESSORIES	
Mounting rail (IEC60715/TH35-7.5)	PR/3/AC, PR/3/AC/ZB, PR/3/AS, PR/3/AS/ZB
Mounting rail (IEC60715/TH35-15)	—
Marking tag	—
Plugin jumper red	CWBK 7-0802 (code X766802)
Plugin jumper white	CWBK 7-0803 (code X766803)
Plugin jumper blue	CWBK 7-0804 (code X766804)
Programming kit	LCONZUSB (code X756894)

APPLICATIONS

LCONAASP is a programmable 4-way isolated converter, it allows to convert, amplify and duplicate a standard analog signal. Input can be set to the standard analog signals 0 ... 20 mA, 4 ... 20 mA and 0 ... 10 V, the signal is isolated, converted and duplicated into two independent signals that can be set to 0 ... 20 mA, 4 ... 20 mA and 0 ... 10 V. The ranges can be set easily through a DIP switch

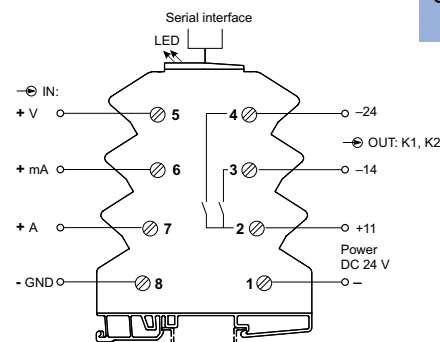

CONVERTERS

- Input: PT100, PT1000, thermocouples, potentiometers
- Output: 2 semiconductor NO contacts
- Insulation: 2.5 kVac, 2-way isolation
- FDT/DTM software programmable ranges

NOTE

(1) Input and output signal range, can be selected using a DIP-switch or customised using FDT/DTM software and LCONZUSB interface

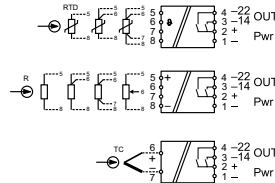

Programming kit X756894

CODE	X756370
TYPE	LCONTLS
INPUT TECHNICAL DATA	
Signal type IN	PT100, PT1000, potentiometer, thermocouples (B, C, E, J, K, N, R, S, T)
Input range IN	-200...+2400 °C (based on sensor) or 0...600 kΩ
Maximum voltage current signal IN	—
Input impedance IN	—
Hysteresis	—
Parametrization IN	FDT/DTM software (1)
OUTPUT TECHNICAL DATA	
Signal type OUT	2 NA contacts (solid state relay)
Output range OUT	30 Vdc / 100 mA
Status indication OUT	LED
Operating mode OUT	limit value, window, trend, inversion and memory
Parametrization OUT	FDT/DTM software (1)
GENERAL TECHNICAL DATA	
Power supply voltage	24 Vdc (16.8...30 Vdc)
Current consumption	12 mA
Auxiliary output voltage	—
Accuracy	0.2% FSR (voltage output) / 0.4% FSR (voltage output)
Linearity error	+0.1% FSR
Temperature coefficient	<100 ppm/K
Setting time	5...500 ms (adjustable, default 30 ms)
Transmission frequency	—
Resolution	16 bit
Rise time	—
Operating temperature range	-40...+70°C
Insulation	2.5 kVac / 60 s
Insulation type	2-way (IN / OUT)
Standard approvals	—
EMC Standards	—
Overvoltage category / Pollution degree	II / 2
Protection degree	IP 20
Connection terminal IN / OUT	1.5 mm ² / 1.5 mm ² (screw)
Housing material	UL94V-0 plastic material
Dimensions	6.2x90x115.5 mm
Approximate weight	40 g
Mounting information	on a rail, side by side
APPROVALS	CE
ACCESSORIES	
Mounting rail (IEC60715/TH35-7.5)	PR/3/AC, PR/3/AC/ZB, PR/3/AS, PR/3/AS/ZB
Mounting rail (IEC60715/TH35-15)	—
Marking tag	—
Plugin jumper red	CWBK 7-0802 (code X766802)
Plugin jumper white	CWBK 7-0803 (code X766803)
Plugin jumper blue	CWBK 7-0804 (code X766804)
Programming kit	LCONZUSB (code X756894)

APPLICATIONS

LCONAASP is a programmable 4-way isolated converter, it allows to convert, amplify and duplicate a standard analog signal. Input can be set to the standard analog signals 0 ... 20 mA, 4 ... 20 mA and 0 ... 10 V, the signal is isolated, converted and duplicated into two independent signals that can be set to 0 ... 20 mA, 4 ... 20 mA and 0 ... 10 V.

The ranges can be set easily through a DIP switch

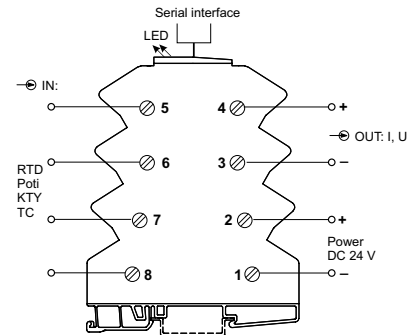

CONVERTERS

THRESHOLD MONITORING FOR CURRENT SIGNAL



- Input: 0...40 A AC
- Output: SPDT contact
- Insulation: 3.0 kVac, 2-way isolation
- Adjustable threshold value



NOTE

[1] The relay is turned on and the transistor output is "high" with input signal under the threshold value

[2] The insulation refers to an uninsulated conductor in contact with the toroid wall. Using insulated conductors, the insulation value of the conductor is added to the isolation value of the converter

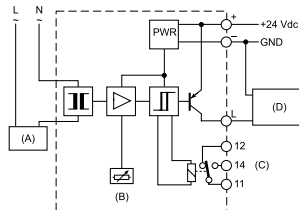

APPLICATIONS

Inserted into a current circuit, the module can be used to set (using a precision potentiometer) the desired current value for the relay or transistor switch, obtaining a current threshold above or below which the switch occurs. The cable carrying the current must be passed through the module's toroidal sensor. The relay or the transistor switches when the set current threshold is surpassed.

- (A) AC Load
- (B) Control threshold
- (C) Exchange output contact
- (D) Transistor-controlled digital input 24 Vac/dc power supply

CODE	XCCIS2
TYPE	CCIS-2
INPUT TECHNICAL DATA	
Signal type IN	analogue
Input range IN	40 A (AC 50...60 Hz)
Maximum voltage current signal IN	600 Vac / 50 A [1]
Input impedance IN	—
Hysteresis	—
Parametrization IN	—
OUTPUT TECHNICAL DATA	
Signal type OUT	SPDT contact , PNP open collector transistor [1]
Output range OUT	100 mA (PNP open collector)
Status indication OUT	LED
Operating mode OUT	limit value
Parametrization OUT	2...40 A ± 10% (trimmer)
GENERAL TECHNICAL DATA	
Power supply voltage	24 Vdc ± 10%
Current consumption	100 mA
Auxiliary output voltage	—
Accuracy	—
Linearity error	—
Temperature coefficient	—
Setting time	20 ms
Transmission frequency	—
Resolution	—
Rise time	—
Operating temperature range	-20...+60°C
Insulation	3.0 kVac / 60 s [2]
Insulation type	2-way (IN / OUT)
Standard approvals	—
EMC Standards	—
Overvoltage category / Pollution degree	II / 2
Protection degree	IP 00
Connection terminal IN / OUT	cable, through in a 13 mm Ø hole / 2.5 mm ² (screw)
Housing material	UL94V-0 plastic material
Dimensions	50x93x70 mm
Approximate weight	100 g
Mounting information	vertical on a rail, distance 5 mm from adjacent components
APPROVALS	CE
ACCESSORIES	
Mounting rail (IEC60715/TH35-7.5)	PR/3/AC, PR/3/AC/ZB, PR/3/AS, PR/3/AS/ZB
Mounting rail (IEC60715/TH35-15)	PR/3/PP, PR/3/PP/ZB, PR/3/PA, PR/3/PA/ZB
Marking tag	—
Plugin jumper red	—
Plugin jumper white	—
Plugin jumper blue	—
Programming kit	—

AUXILIARY SUPPLY FOR SENSORS AND POTENTIOMETERS



- Regulated switching converter
- Suitable for feeding potentiometers and sensors

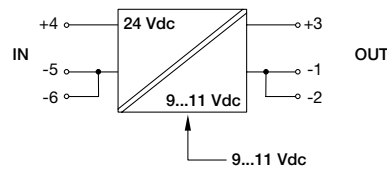

APPLICATIONS

A constant voltage is often required in process control in order to supply power or reference values. A constant voltage source is very often used in digital technology, especially with analogue position sensors (linear potentiometers). This is due to their extremely economical and effective measurements of absolute position, routes, angles and thicknesses. Moreover, the linear potentiometer requires only one continuous voltage and one analogue control or position indicator input.

APPLICATIONS EXAMPLES

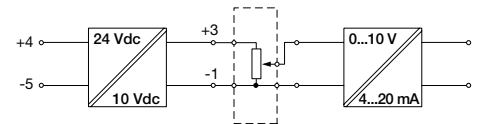

CODE	X766184
TYPE	CWCV 7-6184
INPUT TECHNICAL DATA	
Input rated voltage	24 Vdc (16.8...30 Vdc)
Current consumption	30 mA at 10 Vdc
Internal protection fuse	T 1 A (external)
OUTPUT TECHNICAL DATA	
Output rated voltage	10 Vdc (9...11 Vdc adjustable)
Continuous current	60 mA
Overload limiting	yes
Ripple	≤ 50 mVpp
Status indication	LED "DC OK"
GENERAL TECHNICAL DATA	
Operating temperature range	-25...+60°C
Insulation	50 Vac / 60 s
Insulation type	2-way
Standard approvals	EN 50081-1, EN 50082-2, EN 61000-3-2
EMC Standards	EN61000-4-2, EN61000-4-4
Overvoltage category / Pollution degree	II / 2
Protection degree	IP 20
Connection terminal IN / OUT	1.5 mm ² / 1.5 mm ² (screw)
Housing material	UL94V-0 plastic material
Dimensions	6.2x92.5x90 mm
Approximate weight	35 g
Mounting informations	on a rail, side by side
APPROVALS	CE
ACCESSORIES	
Mounting rail (IEC60715/TH35-7.5)	PR/3/AC, PR/3/AC/ZB, PR/3/AS, PR/3/AS/ZB
Mounting rail (IEC60715/TH35-15)	—
Marking tag	—
Plugin jumper red	CWBK 7-0802 (code X766802)
Plugin jumper white	CWBK 7-0803 (code X766803)
Plugin jumper blue	CWBK 7-0804 (code X766804)

CONVERTERS

SIGNAL INVERTERS NPN AND PNP



- Converts NPN sensors to PNP and vice versa
- Compact dimensions

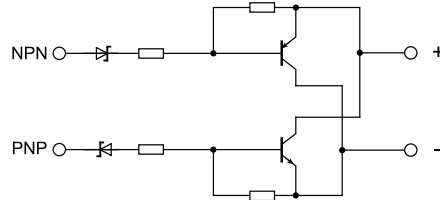

APPLICAZIONI

Converte segnali di sensori PNP in NPN e viceversa. Permette di adattare a qualsiasi ingresso PLC tutti i sensori presenti sul mercato indipendentemente dalla polarità di uscita, ed è di grande aiuto nelle manutenzioni in caso di indisponibilità del sensore di ricambio adatto.

CODE	XNPNPNP
TYPE	CI-NPN/PNP
INPUT TECHNICAL DATA	
Input rated voltage	24 Vdc (17...30 Vdc)
Current consumption	200 mA
Frequency	120 kHz max.
GENERAL TECHNICAL DATA	
Operating temperature range	-20...50°C
Insulation	—
Insulation type	no
Standard approvals	IEC 664-1, DIN VDE
EMC Standards	EN 61000-6-2, EN 61000-6-4
Overvoltage category / Pollution degree	II / 2
Protection degree	IP 00
Connection terminal IN / OUT	2.5 mm ² / 2.5 mm ² (screw)
Housing material	UL94V-0 plastic material
Dimensions	45x12x77 mm
Approximate weight	20 g
Mounting informations	on a rail, side by side
APPROVALS	CE
ACCESSORIES	
Mounting rail (IEC60715/TH35-7.5)	PR/3/AC, PR/3/AC/ZB, PR/3/AS, PR/3/AS/ZB
Mounting rail (IEC60715/TH35-15)	PR/3/PP, PR/3/PP/ZB, PR/3/PA, PR/3/PA/ZB
Marking tag	—
Plugin jumper red	—
Plugin jumper white	—
Plugin jumper blue	—

Conversion from PNP to NPN

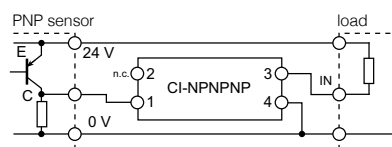

Conversion from NPN to PNP

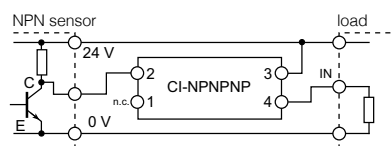

Modbus-RTU programmable analog converters

The XCI04 devices are analog converters, fully programmable through a PC application and with ModBus communication interface.

There are different models:

- XCI04VMB voltage converter
- XCI04IMB current converter
- XCI04RMB thermoresistance and potentiometer converter
- XCI04TMB thermocouple converter
- XCI04RLYMB, actuation module

Each device has up to four independent channels, it is remotely configurable through the ModBus interface and in alternative with a uUSB port with no need for additional power supply.

The devices are fully programmable by means of CaburLab software application or directly accessing the ModBus registers by means of a PLC.

The XCI04RLYMB can be configured to have a default safe condition called safestate that allows to set the state of the output when the power is off and/or when the device is remotely controlled.



Communication bridges

The XBRI series is based on two different interconnection bridge typologies.

The XBRIRS485CP is a gateway which allows the connection between RS-485 interconnected devices towards a ModBus-TCP over Ethernet network .

The XBRIRS485ET and XBRIRS485WI are bridges with the capability to connect RS-485 devices to a 10/100 Base T Ethernet network based upon TCP/IP.

The Ethernet – RS485 communication passes through a virtual communication interface. The bridges parameters can be configured through a dedicated telnet interface (IP address, subnet mask, etc.).



Ethernet Switches

The XSWET5UP and XSWET8UP series of Din-rail Entry-level Unmanaged Ethernet Switches for industrial applications are highly compacted 5 and 8-port Ethernet switches that support IEEE 802.3/802.3u/802.3x with 10/100M, full/half-duplex, RJ45 ports.

The XSWET5UP and XSWET8UP switches are rated to operate at temperatures ranging from -10 to 60°C. The switches can be easily installed on a DIN-rail as well as multi-directional panel mounting.

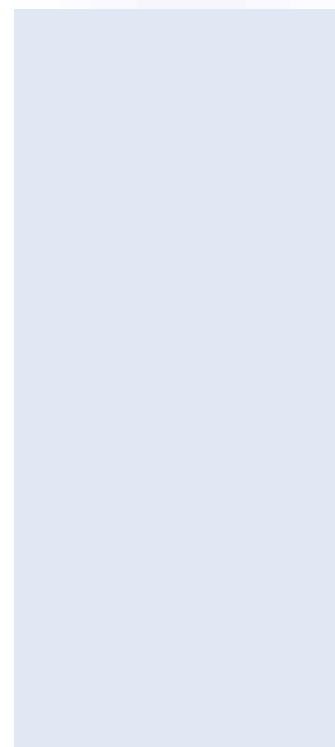

- Modbus RTU output
- Insulation: 1.5 kVac, 3-way isolation
- 4 input channel
- parametrization via Modbus RTU



NOTE

Factory setting: ± 20 mA input

(1) The software CaburLab is available from our web site for free.

CODE	XCI04IMB	XCI04VMB	XCI04RMB
TYPE	CIO4IMB	CIO4VMB	CIO4RMB
INPUT TECHNICAL DATA			
Signal type IN	analogue	analogue	potentiometric 0...2 k Ω , temp. PT100, PT500, PT1000, NI120, NIFE604, CU100, CU120
Input range IN	± 20 mA programmable	± 10 V programmable	-200...+850°C based on sensor (2)
Maximum voltage current signal IN	24 mA	12 V	—
Input impedance IN	56 Ω	1 M Ω	1 M Ω
Parametrization IN	Software CaburLab (1)	Software CaburLab (1)	Software CaburLab (1)
OUTPUT TECHNICAL DATA			
Signal type OUT	Modbus RTU	Modbus RTU	Modbus RTU
Output range OUT	—	—	—
Maximum output signal OUT	—	—	—
Load impedance OUT	—	—	—
Ripple OUT	—	—	—
Status indication OUT	LED	LED	LED
Parametrization OUT	—	—	—
GENERAL TECHNICAL DATA			
Power supply voltage	24 Vdc (8...30 Vdc)	24 Vdc (8...30 Vdc)	24 Vdc (8...30 Vdc)
Current consumption	100 mA (24 Vdc)	100 mA (24 Vdc)	100 mA (24 Vdc)
Accuracy	0.1% FSR (23°C)	0.1% FSR (23°C)	0.1% FSR (23°C)
Linearity error	< 0.1% FS	< 0.1% FS	< 0.1% FS
Temperature coefficient	—	—	—
Setting time	—	—	—
Transmission frequency	10 Hz	10 Hz	10 Hz
Resolution	13 bits	13 bits	13 bits
Rise time	—	—	—
Baud rate	1200 - 320400 bps programmable	1200 - 320400 bps programmable	1200 - 320400 bps programmable
Parity	None, Odd, Even, Mark, Space	None, Odd, Even, Mark, Space	None, Odd, Even, Mark, Space
Operation temperature range	-20...+70°C	-20...+70°C	-20...+70°C
Insulation	1.5 kVac / 60 s	1.5 kVac / 60 s	1.5 kVac / 60 s
Insulation type	3-way (IN / OUT / power)	3-way (IN / OUT / power)	3-way (IN / OUT / power)
Standard approvals	—	—	—
EMC Standards	EN 61000-6-1, EN 61000-6-2, EN 61000-6-3	EN 61000-6-1, EN 61000-6-2, EN 61000-6-3	EN 61000-6-1, EN 61000-6-2, EN 61000-6-3
Overvoltage category / Pollution degree	II / 2	II / 2	II / 2
Protection degree	IP 20	IP 20	IP 20
Connection terminal IN / OUT	2.5 mm ² / 2.5 mm ² (screw)	2.5 mm ² / 2.5 mm ² (screw)	2.5 mm ² / 2.5 mm ² (screw)
Housing material	UL94V-0 plastic material	UL94V-0 plastic material	UL94V-0 plastic material
Dimensions	101x79x17.5 mm	101x79x17.5 mm	101x79x17.5 mm
Approximate weight	100 g	100 g	100 g
Mounting informations	vertical on a rail, distance 5 mm from adjacent components	vertical on a rail, distance 5 mm from adjacent components	vertical on a rail, distance 5 mm from adjacent components
APPROVALS			
ACCESSORIES			
Mounting rail (IEC60715/TH35-7.5)	PR/3/AC, PR/3/AC/ZB, PR/3/AS, PR/3/AS/ZB	PR/3/AC, PR/3/AC/ZB, PR/3/AS, PR/3/AS/ZB	PR/3/AC, PR/3/AC/ZB, PR/3/AS, PR/3/AS/ZB
Mounting rail (IEC60715/TH35-15)	—	—	—

- Modbus RTU output
- Insulation: 1.5 kVac, 3-way isolation
- 4 input channel
- parametrization via Modbus RTU



NOTE

Factory setting: 100mV input

(1) The software CaburLab is available from our web site for free.

CODE	XCI04TMB	XCI04RLYM
TYPE	CIO4TMB	CIO4RLYM
INPUT TECHNICAL DATA		
Signal type IN	thermocouples (J, K, S, R, B, E, T, N), 100mV	Modbus RTU
Input range IN	-270...+1820°C based on sensor (2)	—
Maximum voltage current signal IN	—	—
Input impedance IN	1 MΩ	56 Ω
Parametrization IN	Software CaburLab (1)	—
OUTPUT TECHNICAL DATA		
Signal type OUT	Modbus RTU	4 NO or NC contacts (programmable)
Output range OUT	—	2A @ 30 Vdc / 0.3A @ 125 Vac (resistive load)
Maximum output signal OUT	—	max. 2A 110 Vdc / 2A 125 Vac
Load impedance OUT	—	—
Ripple OUT	—	—
Status indication OUT	LED	LED
Parametrization OUT	—	Software CaburLab (1)
GENERAL TECHNICAL DATA		
Power supply voltage	24 Vdc (8...30 Vdc)	24 Vdc (8...30 Vdc)
Current consumption	100 mA (24 Vdc)	100 mA (24 Vdc)
Accuracy	0.1% FSR (23°C)	0.1% FSR (23°C)
Linearity error	< 0.1% FS	< 0.1% FS
Temperature coefficient	—	—
Setting time	—	—
Transmission frequency	10 Hz	10 Hz
Resolution	13 bits	13 bits
Rise time	—	—
Baud rate	1200 - 320400 bps programmable	1200 - 320400 bps programmable
Parity	None, Odd, Even, Mark, Space	None, Odd, Even, Mark, Space
Operation temperature range	-20...+70°C	-20...+70°C
Insulation	1.5 kVac / 60 s	1.5 kVac / 60 s
Insulation type	3-way (IN / OUT / power)	3-way (IN / OUT / power)
Standard approvals	—	—
EMC Standards	EN 61000-6-1, EN 61000-6-2, EN 61000-6-3	EN 61000-6-1, EN 61000-6-2, EN 61000-6-3
Overvoltage category / Pollution degree	II / 2	II / 2
Protection degree	IP 20	IP 20
Connection terminal IN / OUT	2.5 mm ² / 2.5 mm ² (screw)	2.5 mm ² / 2.5 mm ² (screw)
Housing material	UL94V-0 plastic material	UL94V-0 plastic material
Dimensions	101x79x17.5 mm	101x79x17.5 mm
Approximate weight	100 g	100 g
Mounting informations	vertical on a rail, distance 5 mm from adjacent components	vertical on a rail, distance 5 mm from adjacent components
APPROVALS	CE	CE
ACCESSORIES		
Mounting rail (IEC60715/TH35-7.5)	PR/3/AC, PR/3/AC/ZB, PR/3/AS, PR/3/AS/ZB	PR/3/AC, PR/3/AC/ZB, PR/3/AS, PR/3/AS/ZB
Mounting rail (IEC60715/TH35-15)	—	—

- Communication on RS485—2 wire, Wifi or Ethernet serial line
- Power supply 8...30Vdc
- Configurable by web interface / command prompt
- Signaling LED (GREEN, RED, YELLOW, YELLOW)
- 3 way galvanic isolation
- Compact dimensions



LED "DC OK", LED "Allarm", LED "TX", LED "RX".

CODE	XBRIRS485ET	XBRIRS485WI	XBRIRS485CP
TYPE	BRI—RS485—ET	BRI—RS485—WI	BRI—RS485—CP
TECHNICAL DATA			
WiFi connector	—	RP—SMA WIFI	—
Serial ports	1 RS485	1 RS485	1 RS485
Network interfaces	Ethernet 10/100 (Base TR/TX)	WiFi 802.11b/g	Ethernet 10/100 (Base TR/TX)
Protocol	ModbusRTU/ Ethernet	ModbusRTU/ WiFi	conversion from ModbusRTU/ to Modbus TCP
Speed	up to 1Mbit/s	up to 1Mbit/s	up to 1Mbit/s
MOBUS TECHNICAL DATA			
Speed distance	0,6Km @ 38,4Kbps	0,6Km @ 38,4Kbps	0,6Km @ 38,4Kbps
	0,9Km @ 19,2Kbps	0,9Km @ 19,2Kbps	0,9Km @ 19,2Kbps
	1,2Km @ 9,6Kbps	1,2Km @ 9,6Kbps	1,2Km @ 9,6Kbps
	2Km @ 4,8Kbps	2Km @ 4,8Kbps	2Km @ 4,8Kbps
	3Km @ 2,4Kbps	3Km @ 2,4Kbps	3Km @ 2,4Kbps
	7Km @ 1.2Kbps	7Km @ 1.2Kbps	7Km @ 1.2Kbps
Impedance of RS485 line	120Ω	120Ω	120Ω
Max number of connectable devices in RS485	32	32	32
GENERAL TECHNICAL DATA			
Power supply voltage	8...30 Vdc	8...30 Vdc	8...30 Vdc
Current consumption	≈ 41mA	≈ 41mA	≈ 41mA
Baud rate	1200÷230400 bps (programmable)	1200÷230400 bps (programmable)	1200÷230400 bps (programmable)
Parity	None,Odd, Even, Mark, Space	None,Odd, Even, Mark, Space	None,Odd, Even, Mark, Space
Operating temperature range	−20...+70°C	−20...+70°C	−20...+70°C
Insulation	1.5 kVac /60s	1.5 kVac /60s	1.5 kVac /60s
Insulation type	3 way	3 way	3 way
Standard approvals	—	—	—
EMC Standards	EN 61000—2, EN 61000—4	EN 61000—2, EN 61000—4	EN 61000—2, EN 61000—4
Overvoltage category / Pollution degree	III/2	III/2	III/2
Protection degree	IP20	IP20	IP20
Connection terminal RS485	2.5 mm ²	2.5 mm ²	2.5 mm ²
Connection terminal Ethernet	Shielded RJ45 connector	—	Shielded RJ45 connector
Connection terminal WiFi	—	RP—SMA WiFi	—
Housing material	Blend PC/ABS self—extinguishing	Blend PC/ABS self—extinguishing	Blend PC/ABS self—extinguishing
Dimensions	23x79x101	23x79x101	23x79x101
Approximate weight	100 g	100 g	100 g
Mounting informations	on a rail, side by side	on a rail, side by side	on a rail, side by side
APPROVALS			
ACCESSORIES			
Mounting rail (IEC60715/TH35-7.5)	PR/3/AC, PR/3/AC/ZB, PR/3/AS, PR/3/AS/ZB	PR/3/AC, PR/3/AC/ZB, PR/3/AS, PR/3/AS/ZB	PR/3/AC, PR/3/AC/ZB, PR/3/AS, PR/3/AS/ZB
Mounting rail (IEC60715/TH35-15)	—	—	—
Marking tag	—	—	—

- 5 or 8 port, copper and LC fiber port options
- Designed to meet Level 3 (Heavy) industrial environments
- DIN rail mountable



Available on September 2019

CODE TYPE	XSWET5PU	XSWET8PU
Version	SWET-5PU	SWET-8PU
Version	5 - RJ45	8 - RJ45
TECHNOLOGY		
Standard	IEEE802.3, 802.3u, 802.3x	IEEE802.3, 802.3u, 802.3x
Processing Type	Store and forward with IEEE802.3x full duplex, non-blocking flow control	Store and forward with IEEE802.3x full duplex, non-blocking flow control
Protocols	IEEE802.3x flow control, back pressure flow control	IEEE802.3x flow control, back pressure flow control
SWITCH PROPERTIES		
MAC table size	2K	2K
INTERFACE		
RJ45 Port	10/100BaseT(X) auto negotiation speed, Full/Half duplex mode, and auto MDI/MDI-X connection	10/100BaseT(X) auto negotiation speed, Full/Half duplex mode, and auto MDI/MDI-X connection
LED Indicators	Power, (Link / Speed / Activity for each port)	Power, (Link / Speed / Activity for each port)
GENERAL TECHNICAL DATA		
Power supply voltage	12-24 Vac/dc (12...36 Vdc / (10...24 Vac)	12-24 Vac/dc (12...36 Vdc / (10...24 Vac)
Current consumption	170 mA	170 mA
Operating temperature range	-10 to 60°C	-10 to 60°C
Standard approvals	FCC Part15, CISPR (EN55022) Class A	FCC Part15, CISPR (EN55022) Class A
EMC Standards	EN61000-4-2, EN61000-4-3, EN61000-4-4, EN61000-4-5, EN61000-4-6, EN61000-6-2	EN61000-4-2, EN61000-4-3, EN61000-4-4, EN61000-4-5, EN61000-4-6, EN61000-6-2
Overvoltage category /pollution degree	IP 30	IP 30
Connection type	1.5 mm ² (screw)	1.5 mm ² (screw)
Housing material	Metal Case	Metal Case
Dimensions	25×100×75 mm	24×145×75 mm
Approximate weight	—	—
Mounting informations	on a rail, side by side	on a rail, side by side
APPROVALS	CE FC	CE FC
ACCESSORIES		
Mounting rail (IEC60715/TH35-7.5)	PR/3/AC, PR/3/AC/ZB, PR/3/AS, PR/3/AS/ZB	PR/3/AC, PR/3/AC/ZB, PR/3/AS, PR/3/AS/ZB
Mounting rail (IEC60715/TH35-15)	—	—
Marking tag	—	—

CONVERTERS

Relays

Electromechanical relay modules

Blank lined area for notes.

ELECTROMECHANICAL RELAY MODULES QUICK SELECTION TABLE



INPUT CHANNELS	INPUT RATED VOLTAGE	CONTACT TYPE	NOMINAL CURRENT (RESISTIVE LOAD)	PLUGGABLE RELAY	NOT PLUGGABLE RELAY	POSITIVE CONTROL (PNP)	NEGATIVE CONTROL (NPN)	PROTECTION CIRCUIT	CODE	TYPE	PAGE
1	24 Vdc	SPST(NO)	5 A	-	•	-	-	•	XRFA024D	RFA024D	118
1	24 Vdc	SPDT	16 A	•	-	-	-	•	XRE1824D	RE1824D	119
1	24 Vdc	SPDT	16 A	-	•	-	-	•	XRF1824D	RF1824D	118
1	24 Vdc	SPDT	16 A	•	-	-	-	•	XRE1024D	RE1024D	119
1	24 Vdc	SPDT	16 A	-	•	-	-	•	XRF1024D	RF1024D	118
1	24 Vac/dc	DPDT	10 A	•	-	-	-	•	XRE2024D	RE2024D	119
1	12 Vdc	SPDT	12 A	•	-	-	-	•	XCM1C012	CM1C012	120
1	24 Vdc	SPDT	16 A	•	-	-	-	•	XCM1C024	CM1C024	120
1	48 Vdc	SPDT	10 A	•	-	-	-	•	XCM1C048	CM1C048	120
1	110 Vdc	SPDT	12 A	•	-	-	-	•	XCM1C110	CM1C0110	121
1	12 Vdc	DPDT	8 A	•	-	-	-	•	XCM2C012	CM2C012	122
1	24 Vdc	DPDT	10 A	•	-	-	-	•	XCM2C024	CM2C024	122
1	48 Vdc	DPDT	8 A	•	-	-	-	•	XCM2C048	CM2C048	122
1	110 Vdc	DPDT	8 A	•	-	-	-	•	XCM2C110	CM2C0110	123
1	24 Vdc	4PDT	6 A	•	-	-	-	•	XCM4C024	CM4C024	124
1	12 Vac	SPDT	12 A	•	-	-	-	—	XCM1A012	CM1A012	125
1	24 Vac	SPDT	12 A	•	-	-	-	—	XCM1A024	CM1A024	125
1	120 Vac	SPDT	12 A	•	-	-	-	—	XCM1A120	CM1A120	125
1	230 Vac	SPDT	12 A	•	-	-	-	—	XCM1A230	CM1A230	126
1	12 Vac	DPDT	8 A	•	-	-	-	—	XCM2A012	CM2A012	127
1	24 Vac	DPDT	8 A	•	-	-	-	—	XCM2A024	CM2A024	127
1	120 Vac	DPDT	8 A	•	-	-	-	—	XCM2A120	CM2A120	127
1	230 Vac	DPDT	8 A	•	-	-	-	—	XCM2A230	CM2A230	128
1	24 Vac/dc	SPDT	6 A	-	•	•	•	•	XCKR16	CKR16	129
2	24 Vac/dc	SPST	5 A	-	•	•	•	•	XCKR25	CKR25	129
1	12 Vac/dc	SPDT	6 A	•	-	-	-	•	X766848	CWRE7-0848	130
1	24 Vac/dc	SPDT	6 A	•	-	-	-	•	X766842	CWRE7-0842	130
1	48 Vac/dc	SPDT	6 A	•	-	-	-	•	X766845	CWRE7-0845	130
1	115 Vac/dc	SPDT	6 A	•	-	-	-	•	X766846	CWRE7-0846	131
1	230 Vac	SPDT	6 A	•	-	-	-	•	X766847	CWRE7-0847	131
4	24 Vdc	SPDT	16 A	•	-	•	—	•	XR041E24	R41E24	132
8	24 Vdc	SPDT	16 A	•	-	•	-	•	XR081E24	R81E24	132
16	24 Vdc	SPDT	16 A	•	-	•	-	•	XR161E24	R161E24	132
4	24 Vac/dc	SPDT	16 A	•	-	•	•	•	XR041EAD	R41EAD	133
8	24 Vac/dc	SPDT	16 A	•	-	•	•	•	XR081EAD	R81EAD	133
16	24 Vac/dc	SPDT	16 A	•	-	•	•	•	XR161EAD	R161EAD	133
4	24 Vac/dc	SPDT	16 A	•	-	•	•	•	XR041U24F	R41U24F	134
8	24 Vac/dc	SPDT	16 A	•	-	•	•	•	XR081U24F	R81U24F	134
16	24 Vac/dc	SPDT	16 A	•	-	•	•	•	XR161U24F	R161U24F	134
4	24 Vdc	DPDT	10 A	•	-	•	-	•	XR042E24	R42E24	135
8	24 Vdc	DPDT	10 A	•	-	•	-	•	XR082E24	R82E24	135
16	24 Vdc	DPDT	10 A	•	-	•	-	•	XR162E24	R162E24	135
4	24 Vac/dc	DPDT	10 A	•	-	•	•	•	XR042EAD	R42EAD	136
8	24 Vac/dc	DPDT	10 A	•	-	•	•	•	XR082EAD	R82EAD	136
16	24 Vac/dc	DPDT	10 A	•	-	•	•	•	XR162EAD	R162EAD	136
8	24 Vac/dc	SPDT	16 A	•	-	•	•	•	XRMP081CM	RMP081CM	137
4	24 Vac/dc	SPDT	8 A	•	-	•	•	•	XCRE41	CRE4-1	139
4	24 Vac/dc	SPDT	8 A	-	•	•	•	•	XCR41	CR4-1	138
8	24 Vac/dc	SPST(NO)	8 A	•	-	•	•	•	XCRE81	CRE8-1	139
8	24 Vac/dc	SPST(NO)	8 A	-	•	•	•	•	XCR81	CR8-1	138
4	24 Vac/dc	DPDT	8 A	•	-	•	•	•	XCRE42SC	CRE4-2SC	139
4	24 Vac/dc	DPDT	8 A	-	•	•	•	•	XCR42SC	CR4-2SC	138
8	24 Vac/dc	SPST(NO)	8 A	•	-	•	•	•	XCRE83	CRE8-3	140
8	24 Vac/dc	SPST(NO)	8 A	-	•	•	•	•	XCR83	CR8-3	140

ELECTROMECHANICAL RELAY MODULES SINGLE CHANNEL



- Not-pluggable relay

NOTE

Manufacturer and model of the relay is not binding, technical data are to be considered typical

[1] Version produced upon request; contact our sales office for availability.



PRESENTATION PURPOSE ONLY

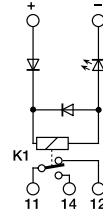
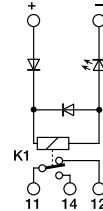
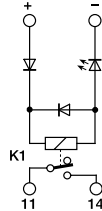

CODE TYPE	RFA024D (1)	XRFA024D	RF1824D	XRF1824D	RF1024D (1)	XRF1024D
INPUT TECHNICAL DATA						
Input rated voltage	24 Vdc ±10%		24 Vdc ±10%		24 Vdc ±10%	
Pull in drop out voltage type	18.4 V / 2.4 V		16.8 V / 2.4 V		16.8 V / 2.4 V	
Current consumption	15 mA ±10%		22 mA ±10%		15 mA ±10%	
Turn ON OFF time	15 ms / 5 ms		10 ms / 5 ms		10 ms / 5 ms	
Frequency	—		—		—	
Protection circuit	Free-wheel diode, Reverse polarity		Free-wheel diode, Reverse polarity		Free-wheel diode, Reverse polarity	
Connection type	2.5 mm ² screw type		2.5 mm ² screw type		2.5 mm ² screw type	
Input channels	1 not pluggable		1 not pluggable		1 not pluggable	
OUTPUT TECHNICAL DATA						
Contact type	SPST(NO), 1 Form A (NO), AgSnO ₂		SPDT, 1 form C, AgSnO ₂		SPDT, 1 form C, AgNi	
Output voltage	—		—		—	
Nominal current	5 A (250 Vac)		16 A (250 Vac)		16 A (250 Vac)	
Max current	10 A		16 A		16 A	
Leakage current with signal 0	—		—		—	
Min applicable load	100 mA / 5 Vdc		—		—	
Max fuse current	—		—		—	
Connection type	2.5 mm ² (AWG26-14), screw type		2.5 mm ² (AWG26-14), screw type		2.5 mm ² (AWG26-14), screw type	
Protection circuit device	—		—		—	
GENERAL TECHNICAL DATA						
Operating temperature range	-20...+70°C		-20...+70°C		-20...+60°C	
Input output isolation	2.5 kVac / 60 s		2.5 kVac / 60 s		2.5 kVac / 60 s	
Protection degree	IP 00		IP 00		IP 00	
Reference Standards	—		—		—	
Overvoltage category pollution degree	II / 2		II / 2		II / 2	
Status indication	LED "Input"		LED "Input"		LED "Input"	
Housing material	UL94V-0 plastic material		UL94V-0 plastic material		UL94V-0 plastic material	
Dimensions	12x77x52 mm		16.4x70x77 mm		16.4x70x77 mm	
Approximate weight	30 g		30 g		30 g	
Mounting information	on a rail, side by side		on a rail, side by side		on a rail, side by side	
APPROVALS	CE		CE		CE	
ACCESSORIES						
Mounting rail IEC60715 TH35 75	PR/3/AC, PR/3/AC/ZB, PR/3/AS, PR/3/AS/ZB		PR/3/AC, PR/3/AC/ZB, PR/3/AS, PR/3/AS/ZB		PR/3/AC, PR/3/AC/ZB, PR/3/AS, PR/3/AS/ZB	
Mounting rail IEC60715 TH35 15	PR/3/PP, PR/3/PP/ZB, PR/3/PA, PR/3/PA/ZB		PR/3/PP, PR/3/PP/ZB, PR/3/PA, PR/3/PA/ZB		PR/3/PP, PR/3/PP/ZB, PR/3/PA, PR/3/PA/ZB	
Marking tag	—		—		—	
Spare part relay	8904075		8904073		8904058	
End section	—		—		—	
Plugin jumper	—		—		—	

ELECTROMECHANICAL RELAY MODULES SINGLE CHANNEL



• Pluggable relay

NOTE
Manufacturer and model of the relay is not binding, technical data are to be considered typical

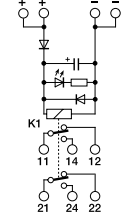
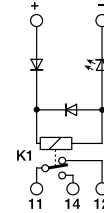
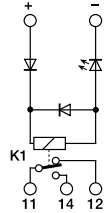

CODE TYPE	XRE1824D	RE1024D	XRE1024D	RE2024D	XRE2024D	
INPUT TECHNICAL DATA						
Input rated voltage	24 Vdc ±10%	24 Vdc ±10%	24 Vdc ±10%	24 Vac/dc ±10%	24 Vac/dc ±10%	
Pull in drop out voltage type	16.8 V / 2.4 V	16.8 V / 2.4 V	16.8 V / 2.4 V	16.8 V / 2.4 V	16.8 V / 2.4 V	
Current consumption	22 mA ±10%	15 mA ±10%	15 mA ±10%	22 mA ±10%	22 mA ±10%	
Turn ON OFF time	10 ms / 5 ms	10 ms / 5 ms	10 ms / 5 ms	10 ms / 5 ms	10 ms / 5 ms	
Frequency	—	—	—	—	—	
Protection circuit	Free-wheel diode, Reverse polarity	Free-wheel diode, Reverse polarity	Free-wheel diode, Reverse polarity	Free-wheel diode, Reverse polarity	Free-wheel diode, Reverse polarity	
Connection type	2.5 mm ² screw type	2.5 mm ² screw type	2.5 mm ² screw type	2.5 mm ² screw type	2.5 mm ² screw type	
Input channels	1 pluggable	1 pluggable	1 pluggable	1 pluggable	1 pluggable	
OUTPUT TECHNICAL DATA						
Contact type	SPDT, 1 form C, AgSnO ₂	SPDT, 1 form C, AgNi	SPDT, 1 form C, AgNi	DPDT, 2 form C, AgSnO ₂	DPDT, 2 form C, AgSnO ₂	
Output voltage	—	—	—	—	—	
Nominal current	16 A (250 Vac)	16 A (250 Vac)	16 A (250 Vac)	10 A (250 Vac)	10 A (250 Vac)	
Max current	16 A	16 A	16 A	10 A	10 A	
Leakage current with signal 0	—	—	—	—	—	
Min applicable load	—	—	—	—	—	
Max fuse current	—	—	—	—	—	
Connection type	2.5 mm ² (AWG26-14), screw type	2.5 mm ² (AWG26-14), screw type	2.5 mm ² (AWG26-14), screw type	2.5 mm ² (AWG26-14), screw type	2.5 mm ² (AWG26-14), screw type	
Protection circuit device	—	—	—	—	—	
GENERAL TECHNICAL DATA						
Operating temperature range	-20...+70°C	-20...+60°C	-20...+60°C	-20...+70°C	-20...+70°C	
Input output isolation	2.5 kVac / 60 s	2.5 kVac / 60 s	2.5 kVac / 60 s	2.5 kVac / 60 s	2.5 kVac / 60 s	
Protection degree	IP 00	IP 00	IP 00	IP 00	IP 00	
Reference Standards	—	—	—	—	—	
Overvoltage category pollution degree	II / 2	II / 2	II / 2	II / 2	II / 2	
Status indication	LED "Input"	LED "Input"	LED "Input"	LED "Input"	LED "Input"	
Housing material	UL94V-0 plastic material	UL94V-0 plastic material	UL94V-0 plastic material	UL94V-0 plastic material	UL94V-0 plastic material	
Dimensions	16.4x70x77 mm	16.4x70x77 mm	16.4x70x77 mm	26x93x75 mm	26x93x75 mm	
Approximate weight	30 g	30 g	30 g	76 g	76 g	
Mounting information	on a rail, side by side	on a rail, side by side	on a rail, side by side	on a rail, side by side	on a rail, side by side	
APPROVALS	CE		CE		CE	
ACCESSORIES						
Mounting rail IEC60715 TH35 75	PR/3/AC, PR/3/AC/ZB, PR/3/AS, PR/3/AS/ZB	PR/3/AC, PR/3/AC/ZB, PR/3/AS, PR/3/AS/ZB	PR/3/AC, PR/3/AC/ZB, PR/3/AS, PR/3/AS/ZB	PR/3/AC, PR/3/AC/ZB, PR/3/AS, PR/3/AS/ZB	PR/3/AC, PR/3/AC/ZB, PR/3/AS, PR/3/AS/ZB	
Mounting rail IEC60715 TH35 15	PR/3/PP, PR/3/PP/ZB, PR/3/PA, PR/3/PA/ZB	PR/3/PP, PR/3/PP/ZB, PR/3/PA, PR/3/PA/ZB	PR/3/PP, PR/3/PP/ZB, PR/3/PA, PR/3/PA/ZB	PR/3/PP, PR/3/PP/ZB, PR/3/PA, PR/3/PA/ZB	PR/3/PP, PR/3/PP/ZB, PR/3/PA, PR/3/PA/ZB	
Marking tag	—	—	—	—	—	
Spare part relay	8904073	8904058	8904058	8904074	8904074	
End section	—	—	—	—	—	
Plugin jumper	—	—	—	—	—	

- Pluggable relay
- DC input voltage
- SPDT contact
- Compact dimensions
- Available plug-in jumper for potential distribution

NOTE

Manufacturer and model of the relay is not binding, technical data are to be considered typical

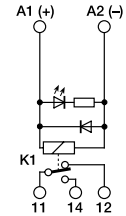
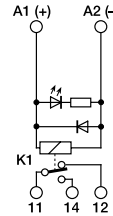
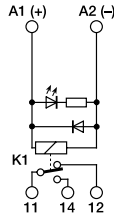

CODE TYPE	CM1C012	XCM1C012	CM1C024	XCM1C024	CM1C048	XCM1C048
INPUT TECHNICAL DATA						
Input rated voltage	12 Vdc ±10%		24 Vdc ±10%		48 Vdc ±10%	
Pull in drop out voltage type	8.4 V / 1.2 V		16.8 V / 2.4 V		33.6 V / 7.2 V	
Current consumption	44 mA ±10%		22 mA ±10%		20 mA ±10%	
Turn ON OFF time	10 ms / 5 ms		10 ms / 5 ms		15 ms / 5 ms	
Frequency	—		—		—	
Protection circuit	Free-wheel diode		Free-wheel diode, Reverse polarity		Free-wheel diode	
Connection type	2.5 mm ² screw type		2.5 mm ² screw type		2.5 mm ² screw type	
Input channels	1 pluggable		1 pluggable		1 pluggable	
OUTPUT TECHNICAL DATA						
Contact type	SPDT, 1 form C, AgNi		SPDT, 1 form C, AgSn02		SPDT, 1 form C, AgSn02	
Output voltage	—		—		—	
Nominal current	12 A (250 Vac)		16 A (250 Vac)		10 A (250 Vac)	
Max current	12 A		16 A		10 A	
Leakage current with signal 0	—		—		—	
Min applicable load	—		—		—	
Max fuse current	—		—		—	
Connection type	2.5 mm ² (AWG26-14), screw type		2.5 mm ² (AWG26-14), screw type		2.5 mm ² (AWG26-14), screw type	
Protection circuit device	—		—		—	
GENERAL TECHNICAL DATA						
Operating temperature range	-20...+60°C		-20...+60°C		-20...+60°C	
Input output isolation	2.5 kVac / 60 s		2.5 kVac / 60 s		2.5 kVac / 60 s	
Protection degree	IP 20		IP 20		IP 20	
Reference Standards	—		—		—	
Overvoltage category pollution degree	II / 2		II / 2		II / 2	
Status indication	LED "Input"		LED "Input"		LED "Input"	
Housing material	UL94V-0 plastic material		UL94V-0 plastic material		UL94V-0 plastic material	
Dimensions	16x75x68 mm		16x75x68 mm		16x75x68 mm	
Approximate weight	54 g		54 g		54 g	
Mounting information	on a rail, side by side		on a rail, side by side		on a rail, side by side	
APPROVALS	CE		CE		CE	
ACCESSORIES						
Mounting rail IEC60715 TH35 75	PR/3/AC, PR/3/AC/ZB, PR/3/AS, PR/3/AS/ZB		PR/3/AC, PR/3/AC/ZB, PR/3/AS, PR/3/AS/ZB		PR/3/AC, PR/3/AC/ZB, PR/3/AS, PR/3/AS/ZB	
Mounting rail IEC60715 TH35 15	—		—		—	
Marking tag	already mounted		already mounted		already mounted	
Spare part relay	8904039		8904001		8904008	
End section	—		—		—	
Plugin jumper	CMB16B (8 poles)		CMB16B (8 poles)		CMB16B (8 poles)	
	—		—		—	
	—		—		—	
	—		—		—	
	—		—		—	

RELAY

- Pluggable relay
- DC input voltage
- SPDT contact
- Compact dimensions
- Available plug-in jumper for potential distribution



NOTE

Manufacturer and model of the relay is not binding, technical data are to be considered typical

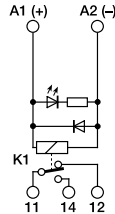

CODE TYPE	CM1C0110	XCM1C110
INPUT TECHNICAL DATA		
Input rated voltage	110 Vdc ±10%	
Pull in drop out voltage type	77 V / 11 V	
Current consumption	11 mA ±10%	
Turn ON OFF time	10 ms / 5 ms	
Frequency	—	
Protection circuit	Free-wheel diode	
Connection type	2.5 mm ² screw type	
Input channels	1 pluggable	
OUTPUT TECHNICAL DATA		
Contact type	SPDT, 1 form C, AgNi	
Output voltage	—	
Nominal current	12 A (250 Vac)	
Max current	12 A	
Leakage current with signal 0	—	
Min applicable load	—	
Max fuse current	—	
Connection type	2.5 mm ² (AWG26-14), screw type	
Protection circuit device	—	
GENERAL TECHNICAL DATA		
Operating temperature range	-20...+60°C	
Input output isolation	2.5 kVac / 60 s	
Protection degree	IP 20	
Reference Standards	—	
Overvoltage category pollution degree	II / 2	
Status indication	LED "Input"	
Housing material	UL94V-0 plastic material	
Dimensions	16x75x68 mm	
Approximate weight	54 g	
Mounting information	on a rail, side by side	
APPROVALS	CE	
ACCESSORIES		
Mounting rail IEC60715 TH35 75	PR/3/AC, PR/3/AC/ZB, PR/3/AS, PR/3/AS/ZB	
Mounting rail IEC60715 TH35 15	—	
Marking tag	already mounted	
Spare part relay	8904047	
End section	—	
Plugin jumper	CMB16B (8 poles)	
	—	
	—	
	—	
	—	

- Pluggable relay
- DC input voltage
- DPDT contact
- Compact dimensions
- Available plug-in jumper for potential distribution

NOTE
Manufacturer and model of the relay is not binding, technical data are to be considered typical

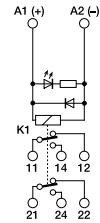
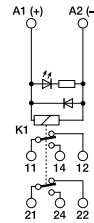
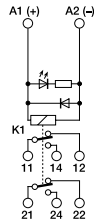

CODE TYPE	XCM2C012	XCM2C024	XCM2C048
INPUT TECHNICAL DATA			
Input rated voltage	12 Vdc ±10%	24 Vdc ±10%	48 Vdc ±10%
Pull in drop out voltage type	8.4 V / 1.2 V	16.8 V / 2.4 V	33.6 V / 4.8 V
Current consumption	44 mA ±10%	22 mA ±10%	24 mA ±10%
Turn ON OFF time	15 ms / 8 ms	10 ms / 5 ms	10 ms / 5 ms
Frequency	—	—	—
Protection circuit	Free-wheel diode	Free-wheel diode, Reverse polarity	Free-wheel diode
Connection type	2.5 mm ² screw type	2.5 mm ² screw type	2.5 mm ² screw type
Input channels	1 pluggable	1 pluggable	1 pluggable
OUTPUT TECHNICAL DATA			
Contact type	DPDT, 2 form C, AgSnO ₂	DPDT, 2 form C, AgSnO ₂	DPDT, 2 form C, AgNi
Output voltage	—	—	—
Nominal current	8 A (250 Vac)	10 A (250 Vac)	8 A (250 Vac)
Max current	8 A	10 A	8 A
Leakage current with signal 0	—	—	—
Min applicable load	—	—	—
Max fuse current	—	—	—
Connection type	2.5 mm ² (AWG26-14), screw type	2.5 mm ² (AWG26-14), screw type	2.5 mm ² (AWG26-14), screw type
Protection circuit device	—	—	—
GENERAL TECHNICAL DATA			
Operating temperature range	-20...+60°C	-20...+60°C	-20...+60°C
Input output isolation	2.5 kVac / 60 s	2.5 kVac / 60 s	2.5 kVac / 60 s
Protection degree	IP 20	IP 20	IP 20
Reference Standards	—	—	—
Overvoltage category pollution degree	II / 2	II / 2	II / 2
Status indication	LED "Input"	LED "Input"	LED "Input"
Housing material	UL94V-0 plastic material	UL94V-0 plastic material	UL94V-0 plastic material
Dimensions	16x75x68 mm	16x75x68 mm	16x75x68 mm
Approximate weight	67 g	67 g	67 g
Mounting information	on a rail, side by side	on a rail, side by side	on a rail, side by side
APPROVALS	CE	CE	CE
ACCESSORIES			
Mounting rail IEC60715 TH35 75	PR/3/AC, PR/3/AC/ZB, PR/3/AS, PR/3/AS/ZB	PR/3/AC, PR/3/AC/ZB, PR/3/AS, PR/3/AS/ZB	PR/3/AC, PR/3/AC/ZB, PR/3/AS, PR/3/AS/ZB
Mounting rail IEC60715 TH35 15	—	—	—
Marking tag	already mounted	already mounted	already mounted
Spare part relay	8904040	8904074	8904053
End section	—	—	—
Plugin jumper	CMB16B (8 poles)	CMB16B (8 poles)	CMB16B (8 poles)
	—	—	—
	—	—	—
	—	—	—
	—	—	—
	—	—	—
	—	—	—

- Pluggable relay
- DC input voltage
- DPDT contact
- Compact dimensions
- Available plug-in jumper for potential distribution

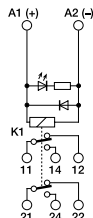

NOTE

Manufacturer and model of the relay is not binding, technical data are to be considered typical

CODE TYPE	CM2C0110	XCM2C110
INPUT TECHNICAL DATA		
Input rated voltage	110 Vdc ±10%	
Pull in drop out voltage type	77 V / 11 V	
Current consumption	11 mA ±10%	
Turn ON OFF time	10 ms / 15 ms	
Frequency	—	
Protection circuit	Free-wheel diode	
Connection type	2.5 mm ² screw type	
Input channels	1 pluggable	
OUTPUT TECHNICAL DATA		
Contact type	DPDT, 2 form C, AgNi	
Output voltage	—	
Nominal current	8 A (250 Vac)	
Max current	8 A	
Leakage current with signal 0	—	
Min applicable load	—	
Max fuse current	—	
Connection type	2.5 mm ² (AWG26-14), screw type	
Protection circuit device	—	
GENERAL TECHNICAL DATA		
Operating temperature range	-20...+60°C	
Input output isolation	2.5 kVac / 60 s	
Protection degree	IP 20	
Reference Standards	—	
Overvoltage category pollution degree	II / 2	
Status indication	LED "Input"	
Housing material	UL94V-0 plastic material	
Dimensions	16x75x68 mm	
Approximate weight	67 g	
Mounting information	on a rail, side by side	
APPROVALS	CE	
ACCESSORIES		
Mounting rail IEC60715 TH35 75	PR/3/AC, PR/3/AC/ZB, PR/3/AS, PR/3/AS/ZB	
Mounting rail IEC60715 TH35 15	—	
Marking tag	already mounted	
Spare part relay	8904054	
End section	—	
Plugin jumper	CMB16B (8 poles)	
	—	
	—	
	—	
	—	

- Pluggable relay
- DC input voltage
- 4PDT contact
- Compact dimensions
- Available plug-in jumper for potential distribution



NOTE

Manufacturer and model of the relay is not binding, technical data are to be considered typical

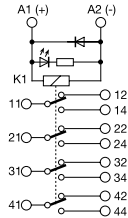

CODE TYPE	CM4C024	XCM4C024
INPUT TECHNICAL DATA		
Input rated voltage	24 Vdc ±10%	
Pull in drop out voltage type	18 V / 2.4 V	
Current consumption	40 mA ±10%	
Turn ON OFF time	20 ms / 20 ms	
Frequency	—	
Protection circuit	Free-wheel diode	
Connection type	2.5 mm ² screw type	
Input channels	1 pluggable	
OUTPUT TECHNICAL DATA		
Contact type	4PDT, 4 form C, AgNi	
Output voltage	—	
Nominal current	6 A (240 Vac)	
Max current	12 A	
Leakage current with signal 0	—	
Min applicable load	10 mA / 12 V	
Max fuse current	—	
Connection type	2.5 mm ² (AWG26-14), screw type	
Protection circuit device	—	
GENERAL TECHNICAL DATA		
Operating temperature range	-20...+60°C	
Input output isolation	2.5 kVac / 60 s	
Protection degree	IP 20	
Reference Standards	—	
Overvoltage category pollution degree	II / 2	
Status indication	LED "Input"	
Housing material	UL94V-0 plastic material	
Dimensions	27x75x68 mm	
Approximate weight	54 g	
Mounting information	on a rail, side by side	
APPROVALS	CE	
ACCESSORIES		
Mounting rail IEC60715 TH35 75	PR/3/AC, PR/3/AC/ZB, PR/3/AS, PR/3/AS/ZB	
Mounting rail IEC60715 TH35 15	—	
Marking tag	already mounted	
Spare part relay	8904069	
End section	—	
Plugin jumper	CMB27B (6 poles)	
	—	
	—	
	—	
	—	
	—	

RELAY

- Pluggable relay
- AC input voltage
- SPDT contact
- Compact dimensions
- Available plug-in jumper for potential distribution

NOTE
Manufacturer and model of the relay is not binding, technical data are to be considered typical

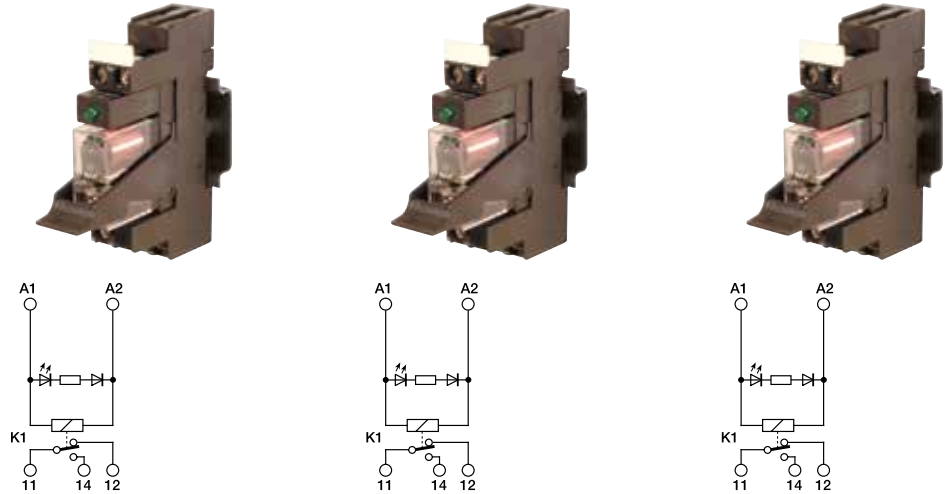

CODE TYPE	XCM1A012	XCM1A024	XCM1A024	XCM1A120	XCM1A120
INPUT TECHNICAL DATA					
Input rated voltage	12 Vac ±10%	24 Vac ±10%	24 Vac ±10%	120 Vac ±10%	120 Vac ±10%
Pull in drop out voltage type	9.6 V / 3.6 V	18 V / 3.6 V	18 V / 3.6 V	86.3 V / 17.3 V	86.3 V / 17.3 V
Current consumption	95 mA ±10%	48 mA ±10%	48 mA ±10%	10.5 mA ±10%	10.5 mA ±10%
Turn ON OFF time	15 ms / 10 ms	10 ms / 5 ms	10 ms / 5 ms	10 ms / 5 ms	10 ms / 5 ms
Frequency	—	—	—	—	—
Protection circuit	—	—	—	—	—
Connection type	2.5 mm ² screw type	2.5 mm ² screw type	2.5 mm ² screw type	2.5 mm ² screw type	2.5 mm ² screw type
Input channels	1 pluggable	1 pluggable	1 pluggable	1 pluggable	1 pluggable
OUTPUT TECHNICAL DATA					
Contact type	SPDT, 1 form C, AgSnO ₂	SPDT, 1 form C, AgNi	SPDT, 1 form C, AgNi	SPDT, 1 form C, AgNi	SPDT, 1 form C, AgNi
Output voltage	—	—	—	—	—
Nominal current	12 A (250 Vac)	12 A (250 Vac)	12 A (250 Vac)	12 A (250 Vac)	12 A (250 Vac)
Max current	12 A	12 A	12 A	12 A	12 A
Leakage current with signal 0	—	—	—	—	—
Min applicable load	—	—	—	—	—
Max fuse current	—	—	—	—	—
Connection type	2.5 mm ² (AWG26-14), screw type	2.5 mm ² (AWG26-14), screw type	2.5 mm ² (AWG26-14), screw type	2.5 mm ² (AWG26-14), screw type	2.5 mm ² (AWG26-14), screw type
Protection circuit device	—	—	—	—	—
GENERAL TECHNICAL DATA					
Operating temperature range	-20...+60°C	-20...+60°C	-20...+60°C	-20...+60°C	-20...+60°C
Input output isolation	2.5 kVac / 60 s	2.5 kVac / 60 s	2.5 kVac / 60 s	2.5 kVac / 60 s	2.5 kVac / 60 s
Protection degree	IP 20	IP 20	IP 20	IP 20	IP 20
Reference Standards	—	—	—	—	—
Overvoltage category pollution degree	II / 2	II / 2	II / 2	II / 2	II / 2
Status indication	LED "Input"	LED "Input"	LED "Input"	LED "Input"	LED "Input"
Housing material	UL94V-0 plastic material	UL94V-0 plastic material	UL94V-0 plastic material	UL94V-0 plastic material	UL94V-0 plastic material
Dimensions	16x75x68 mm	16x75x68 mm	16x75x68 mm	16x75x68 mm	16x75x68 mm
Approximate weight	54 g	54 g	54 g	54 g	54 g
Mounting information	on a rail, side by side	on a rail, side by side	on a rail, side by side	on a rail, side by side	on a rail, side by side
APPROVALS	CE	CE	CE	CE	CE
ACCESSORIES					
Mounting rail IEC60715 TH35 75	PR/3/AC, PR/3/AC/ZB, PR/3/AS, PR/3/AS/ZB	PR/3/AC, PR/3/AC/ZB, PR/3/AS, PR/3/AS/ZB	PR/3/AC, PR/3/AC/ZB, PR/3/AS, PR/3/AS/ZB	PR/3/AC, PR/3/AC/ZB, PR/3/AS, PR/3/AS/ZB	PR/3/AC, PR/3/AC/ZB, PR/3/AS, PR/3/AS/ZB
Mounting rail IEC60715 TH35 15	—	—	—	—	—
Marking tag	already mounted	already mounted	already mounted	already mounted	already mounted
Spare part relay	8904071	8904048	8904048	8904049	8904049
End section	—	—	—	—	—
Plugin jumper	CMB16B (8 poles) — — — — —	CMB16B (8 poles) — — — — —	CMB16B (8 poles) — — — — —	CMB16B (8 poles) — — — — —	CMB16B (8 poles) — — — — —

- Pluggable relay
- AC input voltage
- SPDT contact
- Compact dimensions
- Available plug-in jumper for potential distribution



NOTE

Manufacturer and model of the relay is not binding, technical data are to be considered typical

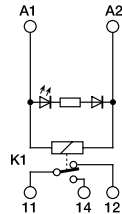

CODE TYPE	XCM1A230
INPUT TECHNICAL DATA	CM1A230
Input rated voltage	230 Vac ±10%
Pull in drop out voltage type	172.5 V / 34.5 V
Current consumption	6 mA ±10%
Turn ON OFF time	10 ms / 5 ms
Frequency	—
Protection circuit	—
Connection type	2.5 mm ² screw type
Input channels	1 pluggable
OUTPUT TECHNICAL DATA	
Contact type	SPDT, 1 form C, AgNi
Output voltage	—
Nominal current	12 A (250 Vac)
Max current	12 A
Leakage current with signal 0	—
Min applicable load	—
Max fuse current	—
Connection type	2.5 mm ² (AWG26-14), screw type
Protection circuit device	—
GENERAL TECHNICAL DATA	
Operating temperature range	-20...+60°C
Input output isolation	2.5 kVac / 60 s
Protection degree	IP 20
Reference Standards	—
Overvoltage category pollution degree	II / 2
Status indication	LED "Input"
Housing material	UL94V-0 plastic material
Dimensions	16x75x68 mm
Approximate weight	54 g
Mounting information	on a rail, side by side
APPROVALS	CE
ACCESSORIES	
Mounting rail IEC60715 TH35 75	PR/3/AC, PR/3/AC/ZB, PR/3/AS, PR/3/AS/ZB
Mounting rail IEC60715 TH35 15	—
Marking tag	already mounted
Spare part relay	8904050
End section	—
Plugin jumper	CMB16B (8 poles)
	—
	—
	—
	—

RELAY

- Pluggable relay
- AC input voltage
- DPDT contact
- Compact dimensions
- Available plug-in jumper for potential distribution

NOTE
Manufacturer and model of the relay is not binding, technical data are to be considered typical

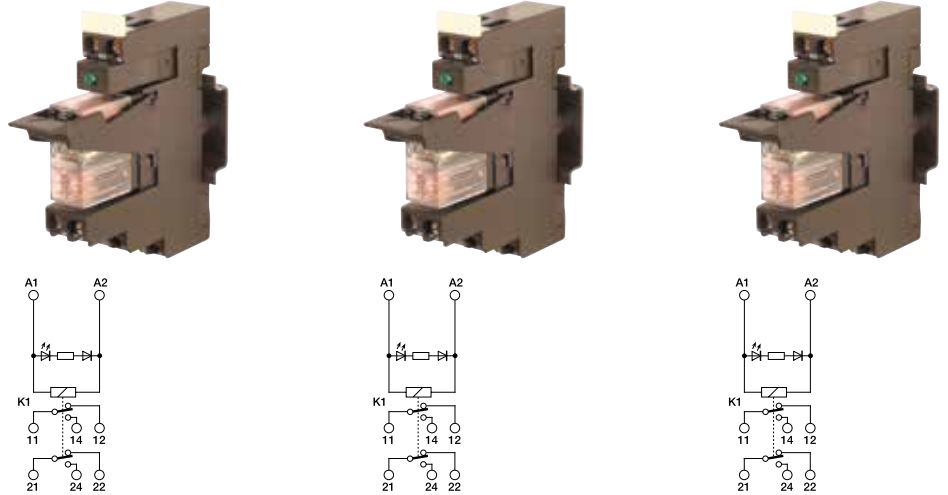

CODE TYPE	XCM2A012	XCM2A024	XCM2A120
INPUT TECHNICAL DATA			
Input rated voltage	12 Vac ±10%	24 Vac ±10%	120 Vac ±10%
Pull in drop out voltage type	9.6 V / 3.6 V	18 V / 3.6 V	86.3 V / 17.3 V
Current consumption	95 mA ±10%	48 mA ±10%	11 mA ±10%
Turn ON OFF time	15 ms / 10 ms	10 ms / 5 ms	10 ms / 15 ms
Frequency	—	—	—
Protection circuit	—	—	—
Connection type	2.5 mm ² screw type	2.5 mm ² screw type	2.5 mm ² screw type
Input channels	1 pluggable	1 pluggable	1 pluggable
OUTPUT TECHNICAL DATA			
Contact type	DPDT, 2 form C, AgSnO ₂	DPDT, 2 form C, AgNi	DPDT, 2 form C, AgSnO ₂
Output voltage	—	—	—
Nominal current	8 A (250 Vac)	8 A (250 Vac)	8 A (250 Vac)
Max current	8 A	8 A	8 A
Leakage current with signal 0	—	—	—
Min applicable load	—	—	—
Max fuse current	—	—	—
Connection type	2.5 mm ² (AWG26-14), screw type	2.5 mm ² (AWG26-14), screw type	2.5 mm ² (AWG26-14), screw type
Protection circuit device	—	—	—
GENERAL TECHNICAL DATA			
Operating temperature range	-20...+60°C	-20...+60°C	-20...+60°C
Input output isolation	2.5 kVac / 60 s	2.5 kVac / 60 s	2.5 kVac / 60 s
Protection degree	IP 20	IP 20	IP 20
Reference Standards	—	—	—
Overvoltage category pollution degree	II / 2	II / 2	II / 2
Status indication	LED "Input"	LED "Input"	LED "Input"
Housing material	UL94V-0 plastic material	UL94V-0 plastic material	UL94V-0 plastic material
Dimensions	16x75x68 mm	16x75x68 mm	16x75x68 mm
Approximate weight	67 g	67 g	67 g
Mounting information	on a rail, side by side	on a rail, side by side	on a rail, side by side
APPROVALS	CE	CE	CE
ACCESSORIES			
Mounting rail IEC60715 TH35 75	PR/3/AC, PR/3/AC/ZB, PR/3/AS, PR/3/AS/ZB	PR/3/AC, PR/3/AC/ZB, PR/3/AS, PR/3/AS/ZB	PR/3/AC, PR/3/AC/ZB, PR/3/AS, PR/3/AS/ZB
Mounting rail IEC60715 TH35 15	—	—	—
Marking tag	already mounted	already mounted	already mounted
Spare part relay	8904068	8904055	8904056
End section	—	—	—
Plugin jumper	CMB16B (8 poles)	CMB16B (8 poles)	CMB16B (8 poles)
	—	—	—
	—	—	—
	—	—	—
	—	—	—
	—	—	—
	—	—	—

- Pluggable relay
- AC input voltage
- DPDT contact
- Compact dimensions
- Available plug-in jumper for potential distribution

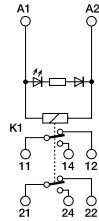

NOTE
Manufacturer and model of the relay is not binding, technical data are to be considered typical

CODE	XCM2A230
TYPE	CM2A230
INPUT TECHNICAL DATA	
Input rated voltage	230 Vac ±10%
Pull in drop out voltage type	172.5 V / 34.5 V
Current consumption	6 mA ±10%
Turn ON OFF time	10 ms / 5 ms
Frequency	—
Protection circuit	—
Connection type	2.5 mm ² screw type
Input channels	1 pluggable
OUTPUT TECHNICAL DATA	
Contact type	DPDT, 2 form C, AgNi
Output voltage	—
Nominal current	8 A (250 Vac)
Max current	8 A
Leakage current with signal 0	—
Min applicable load	—
Max fuse current	—
Connection type	2.5 mm ² (AWG26-14), screw type
Protection circuit device	—
GENERAL TECHNICAL DATA	
Operating temperature range	-20...+60°C
Input output isolation	2.5 kVac / 60 s
Protection degree	IP 20
Reference Standards	—
Overvoltage category pollution degree	II / 2
Status indication	LED "Input"
Housing material	UL94V-0 plastic material
Dimensions	16x75x68 mm
Approximate weight	67 g
Mounting information	on a rail, side by side
APPROVALS	CE
ACCESSORIES	
Mounting rail IEC60715 TH35 75	PR/3/AC, PR/3/AC/ZB, PR/3/AS, PR/3/AS/ZB
Mounting rail IEC60715 TH35 15	—
Marking tag	already mounted
Spare part relay	8904057
End section	—
Plugin jumper	CMB16B (8 poles)
	—
	—
	—
	—

RELAY

- Not-pluggable relay
- Allow PNP and NPN command
- Available plug-in jumper for potential distribution



NOTE

Manufacturer and model of the relay is not binding, technical data are to be considered typical

(1) Version produced upon request; contact our sales office for availability.

(2) the output contact is protected by a 7.5 A replaceable fuse. It can be replaced with a lower value according to the output load and wiring. Greater values than 7.5 A is not allowed. The fuse is suitable for SELV ≤ 50 Vac and ≤ 75 Vdc voltages; if used with greater voltages it will not guarantee cut-off capability and safe operation.

(3) the final module must always be protected with the CK/PT end plate to ensure an IP20 protection degree

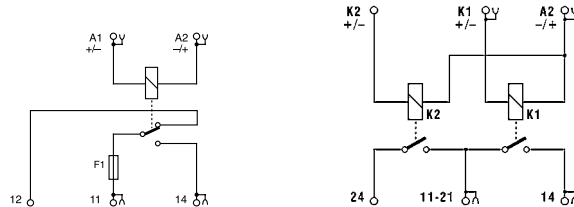

CODE TYPE	XCKR16	XCKR25
INPUT TECHNICAL DATA		
Input rated voltage	24 Vac/dc $\pm 10\%$	24 Vac/dc $\pm 10\%$
Pull in/drop out voltage type	18 V / 1.2 V	18 V / 1.2 V
Current consumption	15 mA $\pm 10\%$	13 mA $\pm 10\%$
Turn ON/OFF time	10 ms / 5 ms	10 ms / 5 ms
Frequency	—	—
Protection circuit	Free-wheel diode	Free-wheel diode
Connection type	2.5 mm ² spring type	2.5 mm ² spring type
Input channels	1 not pluggable	2 not pluggable
OUTPUT TECHNICAL DATA		
Contact type	SPDT, 1 form C, AgSnO ₂	SPST(NO), 1 Form A (NO), AgSnO ₂
Output voltage	—	—
Nominal current	6 A (30 Vac)	5 A (250 Vac)
Max current	10 A peak [2]	10 A
Leakage current with signal 0	—	—
Min applicable load	—	—
Max fuse current	7.5 A [2]	—
Connection type	2.5 mm ² (AWG26-14), spring type	2.5 mm ² (AWG26-14), spring type
Protection circuit device	replaceable fuse [2]	—
GENERAL TECHNICAL DATA		
Operating temperature range	-20...+60°C	-20...+60°C
Input/output isolation	3 kVac / 60 s	3 kVac / 60 s
Protection degree	IP 00 / IP20 [3]	IP 00 / IP20 [3]
Reference Standards	—	—
Oversvoltage category/pollution degree	II / 2	II / 2
Status indication	LED "Input"	LED "Input"
Housing material	UL94V-0 plastic material	UL94V-0 plastic material
Dimensions	6x91x100 mm	6x91x100 mm
Approximate weight	40 g	43 g
Mounting information	on a rail, side by side	on a rail, side by side
APPROVALS	CE	CE
ACCESSORIES		
Mounting rail IEC60715 TH35 75	PR/3/AC, PR/3/AC/ZB, PR/3/AS, PR/3/AS/ZB	PR/3/AC, PR/3/AC/ZB, PR/3/AS, PR/3/AS/ZB
Mounting rail IEC60715 TH35 15	—	—
Marking tag	NU0851	NU0851
Spare part relay	—	—
End section	XCKPT	XCKPT
Plugin jumper	PTC/4/02 (2 poles) PTC/4/03 (3 poles) PTC/4/04 (4 poles) PTC/4/05 (5 poles) PTC/4/10 (10 poles) PTC/4/00 (42 poles)	PTC/4/02 (2 poles) PTC/4/03 (3 poles) PTC/4/04 (4 poles) PTC/4/05 (5 poles) PTC/4/10 (10 poles) PTC/4/00 (42 poles)

- Pluggable relay
- AC/DC input voltage
- SPDT contact
- Compact dimensions
- Available plug-in jumper for potential distribution

NOTE

Manufacturer and model of the relay is not binding, technical data are to be considered typical

(1) Version produced upon request; contact our sales office for availability.

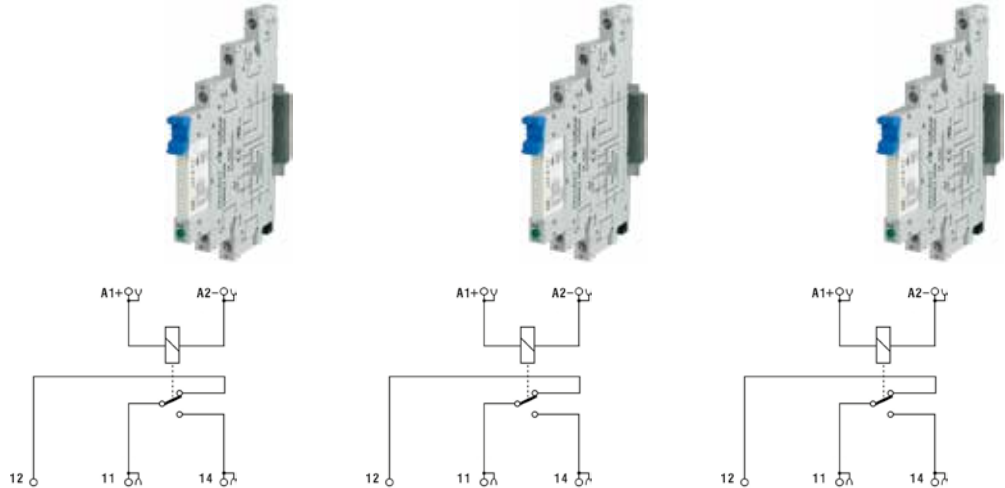

CODE TYPE	CWRE7-0848 (1) X766848	CWRE7-0842 X766842	CWRE7-0845 (1) X766845
INPUT TECHNICAL DATA			
Input rated voltage	12 Vac/dc ±10%	24 Vac/dc ±10%	48 Vac/dc ±10%
Pull in/drop out voltage type	9 V / 0.6 V	18 V / 1.2 V	36 V / 2.4 V
Current consumption	10 mA ±10%	7 mA ±10%	5 mA ±10%
Turn ON/OFF time	8 ms / 5 ms	8 ms / 5 ms	8 ms / 5 ms
Frequency	—	—	—
Protection circuit	Free-wheel diode, Reverse polarity	Free-wheel diode, Reverse polarity	Free-wheel diode, Reverse polarity
Connection type	2.5 mm ² screw type	2.5 mm ² screw type	2.5 mm ² screw type
Input channels	1 pluggable	1 pluggable	1 pluggable
OUTPUT TECHNICAL DATA			
Contact type	SPDT, 1 form C, AgSnO ₂	SPDT, 1 form C, AgSnO ₂	SPDT, 1 form C, AgSnO ₂
Output voltage	400 Vac max., 30 Vdc max.	400 Vac max., 30 Vdc max.	400 Vac max., 30 Vdc max.
Nominal current	6 A (250 Vac), 6 A (30 Vdc)	6 A (250 Vac), 6 A (30 Vdc)	6 A (250 Vac), 6 A (30 Vdc)
Max current	—	—	—
Leakage current with signal 0	—	—	—
Min applicable load	—	—	—
Max fuse current	—	—	—
Connection type	2.5 mm ² (AWG26-14), screw type	2.5 mm ² (AWG26-14), screw type	2.5 mm ² (AWG26-14), screw type
Protection circuit device	—	—	—
GENERAL TECHNICAL DATA			
Operating temperature range	-20...+70°C	-20...+70°C	-20...+70°C
Input/output isolation	4 kVac / 60 s	4 kVac / 60 s	4 kVac / 60 s
Protection degree	IP 20	IP 20	IP 20
Reference Standards	—	—	—
Overvoltage category/pollution degree	II / 2	II / 2	II / 2
Status indication	LED "Input"	LED "Input"	LED "Input"
Housing material	UL94V-0 plastic material	UL94V-0 plastic material	UL94V-0 plastic material
Dimensions	6.2x89x77 mm	6.2x89x77 mm	6.2x89x77 mm
Approximate weight	35 g	35 g	35 g
Mounting information	on a rail, side by side	on a rail, side by side	on a rail, side by side
APPROVALS			
ACCESSORIES			
Mounting rail IEC60715 TH35 75	PR/3/AC, PR/3/AC/ZB, PR/3/AS, PR/3/AS/ZB	PR/3/AC, PR/3/AC/ZB, PR/3/AS, PR/3/AS/ZB	PR/3/AC, PR/3/AC/ZB, PR/3/AS, PR/3/AS/ZB
Mounting rail IEC60715 TH35 15	—	—	—
Marking tag	NUPUTUK50	NUPUTUK50	NUPUTUK50
Spare part relay	—	8904027	—
End section	—	—	—
Plugin jumper	CWBK7-0813 (20 poles) — — — — —	CWBK7-0813 (20 poles) — — — — —	CWBK7-0813 (20 poles) — — — — —





RELAY

- Pluggable relay
- AC/DC input voltage
- SPDT contact
- Compact dimensions
- Available plug-in jumper for potential distribution

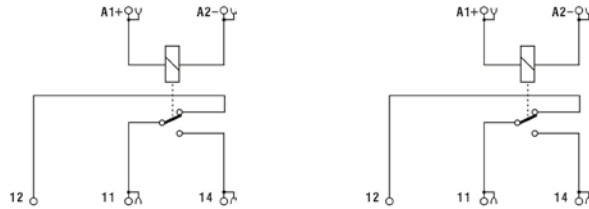
NOTE

Manufacturer and model of the relay is not binding, technical data are to be considered typical



CODE TYPE	X766846	X766847
INPUT TECHNICAL DATA	CWRE7-0846	CWRE7-0847
Input rated voltage	115 Vac/dc ±10%	230 Vac ±10%
Pull in/drop out voltage type	—	—
Current consumption	4 mA ±10%	4 mA ±10%
Turn ON/OFF time	8 ms / 5 ms	8 ms / 5 ms
Frequency	—	—
Protection circuit	Free-wheel diode, Reverse polarity	Free-wheel diode, Reverse polarity
Connection type	2.5 mm ² screw type	2.5 mm ² screw type
Input channels	1 pluggable	1 pluggable
OUTPUT TECHNICAL DATA		
Contact type	SPDT, 1 form C, AgSnO ₂	SPDT, 1 form C, AgSnO ₂
Output voltage	400 Vac max., 30 Vdc max.	400 Vac max., 30 Vdc max.
Nominal current	6 A (250 Vac), 6 A (30 Vdc)	6 A (250 Vac), 6 A (30 Vdc)
Max current	—	—
Leakage current with signal 0	—	—
Min applicable load	—	—
Max fuse current	—	—
Connection type	2.5 mm ² (AWG26-14), screw type	2.5 mm ² (AWG26-14), screw type
Protection circuit device	—	—
GENERAL TECHNICAL DATA		
Operating temperature range	-20...+70°C	-20...+70°C
Input/output isolation	4 kVac / 60 s	4 kVac / 60 s
Protection degree	IP 20	IP 20
Reference Standards	—	—
Overvoltage category/pollution degree	II / 2	II / 2
Status indication	LED "Input"	LED "Input"
Housing material	UL94V-0 plastic material	UL94V-0 plastic material
Dimensions	6.2x89x77 mm	6.2x89x77 mm
Approximate weight	35 g	35 g
Mounting information	on a rail, side by side	on a rail, side by side
APPROVALS	 	 
ACCESSORIES		
Mounting rail IEC60715 TH35 75	PR/3/AC, PR/3/AC/ZB, PR/3/AS, PR/3/AS/ZB	PR/3/AC, PR/3/AC/ZB, PR/3/AS, PR/3/AS/ZB
Mounting rail IEC60715 TH35 15	—	—
Marking tag	NUPUTUK50	NUPUTUK50
Spare part relay	—	—
End section	—	—
Plugin jumper	CWBK7-0813 (20 poles)	CWBK7-0813 (20 poles)
	—	—
	—	—
	—	—
	—	—

ELECTROMECHANICAL RELAY MODULES MULTI-CHANNEL



- Pluggable relay
- DC input voltage
- SPDT contact
- Coils with negative common and positive command (PNP)



NOTE

Manufacturer and model of the relay is not binding, technical data are to be considered typical

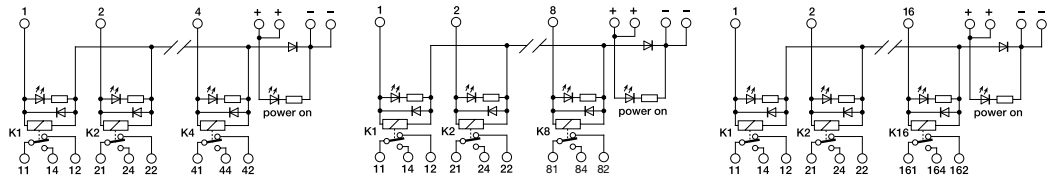

CODE TYPE	R41E24	XR041E24	R81E24	XR081E24	R161E24	XR161E24
INPUT TECHNICAL DATA						
Input rated voltage	24 Vdc ±10%		24 Vdc ±10%		24 Vdc ±10%	
Pull in drop out voltage type	16.8 V / 2.4 V		16.8 V / 2.4 V		16.8 V / 2.4 V	
Current consumption	22 mA ±10%		22 mA ±10%		22 mA ±10%	
Turn ON OFF time	10 ms / 5 ms		10 ms / 5 ms		10 ms / 5 ms	
Frequency	—		—		—	
Protection circuit	Free-wheel diode, Reverse polarity		Free-wheel diode, Reverse polarity		Free-wheel diode, Reverse polarity	
Connection type	2.5 mm ² screw type		2.5 mm ² screw type and 16 poles connector		2.5 mm ² screw type and 20 poles connector	
Input channels	4 pluggable		8 pluggable		16 pluggable	
OUTPUT TECHNICAL DATA						
Contact type	SPDT, 1 form C, AgSnO ₂		SPDT, 1 form C, AgSnO ₂		SPDT, 1 form C, AgSnO ₂	
Output voltage	—		—		—	
Nominal current	16 A (250 Vac)		16 A (250 Vac)		16 A (250 Vac)	
Max current	16 A		16 A		16 A	
Leakage current with signal 0	—		—		—	
Min applicable load	—		—		—	
Max fuse current	—		—		—	
Connection type	2.5 mm ² (AWG26-14), screw type		2.5 mm ² (AWG26-14), screw type		2.5 mm ² (AWG26-14), screw type	
Protection circuit device	—		—		—	
GENERAL TECHNICAL DATA						
Operating temperature range	-20...+70°C		-20...+70°C		-20...+70°C	
Input output isolation	2.5 kVac / 60 s		2.5 kVac / 60 s		2.5 kVac / 60 s	
Protection degree	IP 00		IP 00		IP 00	
Reference Standards	—		—		—	
Overvoltage category pollution degree	II / 2		II / 2		II / 2	
Status indication	LED "DC OK" / LED "Relay"		LED "DC OK" / LED "Relay"		LED "DC OK" / LED "Relay"	
Housing material	UL94V-0 plastic material		UL94V-0 plastic material		UL94V-0 plastic material	
Dimensions	70x93x75 mm		137x93x75 mm		250x93x75 mm	
Approximate weight	188 g		342 g		657 g	
Mounting information	on a rail, side by side		on a rail, side by side		on a rail, side by side	
APPROVALS	CE		CE		CE	
ACCESSORIES						
Mounting rail IEC60715 TH35 75	PR/3/AC, PR/3/AC/ZB, PR/3/AS, PR/3/AS/ZB		PR/3/AC, PR/3/AC/ZB, PR/3/AS, PR/3/AS/ZB		PR/3/AC, PR/3/AC/ZB, PR/3/AS, PR/3/AS/ZB	
Mounting rail IEC60715 TH35 15	PR/3/PP, PR/3/PP/ZB, PR/3/PA, PR/3/PA/ZB		PR/3/PP, PR/3/PP/ZB, PR/3/PA, PR/3/PA/ZB		PR/3/PP, PR/3/PP/ZB, PR/3/PA, PR/3/PA/ZB	
Marking tag	—		—		—	
Spare part relay	8904073		8904073		8904073	
End section	—		—		—	
Plugin jumper	—		—		—	

ELECTROMECHANICAL RELAY MODULES MULTI-CHANNEL



- Pluggable relay
- AC/DC input voltage
- SPDT contact
- Allow PNP and NPN command



NOTE
Manufacturer and model of the relay is not binding, technical data are to be considered typical

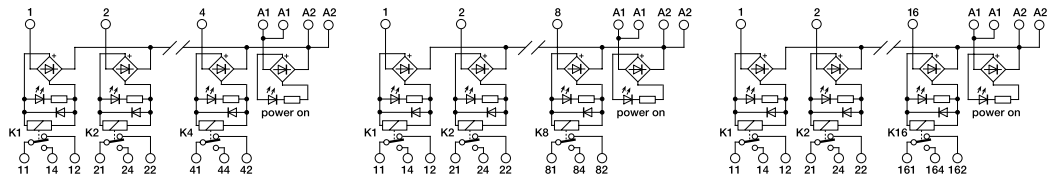

CODE TYPE	R41EAD	XR041EAD	R81EAD	XR081EAD	R161EAD	XR161EAD
INPUT TECHNICAL DATA						
Input rated voltage	24 Vac/dc ±10%		24 Vac/dc ±10%		24 Vac/dc ±10%	
Pull in drop out voltage type	16.8 V / 2.4 V		16.8 V / 2.4 V		16.8 V / 2.4 V	
Current consumption	22 mA ±10%		22 mA ±10%		22 mA ±10%	
Turn ON OFF time	10 ms / 5 ms		10 ms / 5 ms		10 ms / 5 ms	
Frequency	—		—		—	
Protection circuit	Free-wheel diode, Reverse polarity		Free-wheel diode, Reverse polarity		Free-wheel diode, Reverse polarity	
Connection type	2.5 mm ² screw type		2.5 mm ² screw type and 16 poles connector		2.5 mm ² screw type and 20 poles connector	
Input channels	4 pluggable		8 pluggable		16 pluggable	
OUTPUT TECHNICAL DATA						
Contact type	SPDT, 1 form C, AgSnO ₂		SPDT, 1 form C, AgSnO ₂		SPDT, 1 form C, AgSnO ₂	
Output voltage	—		—		—	
Nominal current	16 A (250 Vac)		16 A (250 Vac)		16 A (250 Vac)	
Max current	16 A		16 A		16 A	
Leakage current with signal 0	—		—		—	
Min applicable load	—		—		—	
Max fuse current	—		—		—	
Connection type	2.5 mm ² (AWG26-14), screw type		2.5 mm ² (AWG26-14), screw type		2.5 mm ² (AWG26-14), screw type	
Protection circuit device	—		—		—	
GENERAL TECHNICAL DATA						
Operating temperature range	-20...+70°C		-20...+70°C		-20...+70°C	
Input output isolation	2.5 kVac / 60 s		2.5 kVac / 60 s		2.5 kVac / 60 s	
Protection degree	IP 00		IP 00		IP 00	
Reference Standards	—		—		—	
Overvoltage category pollution degree	II / 2		II / 2		II / 2	
Status indication	LED "DC OK" / LED "Relay"		LED "DC OK" / LED "Relay"		LED "DC OK" / LED "Relay"	
Housing material	UL94V-0 plastic material		UL94V-0 plastic material		UL94V-0 plastic material	
Dimensions	70x93x75 mm		137x93x75 mm		250x93x75 mm	
Approximate weight	192 g		345 g		688 g	
Mounting information	on a rail, side by side		on a rail, side by side		on a rail, side by side	
APPROVALS	CE		CE		CE	
ACCESSORIES						
Mounting rail IEC60715 TH35 75	PR/3/AC, PR/3/AC/ZB, PR/3/AS, PR/3/AS/ZB		PR/3/AC, PR/3/AC/ZB, PR/3/AS, PR/3/AS/ZB		PR/3/AC, PR/3/AC/ZB, PR/3/AS, PR/3/AS/ZB	
Mounting rail IEC60715 TH35 15	PR/3/PP, PR/3/PP/ZB, PR/3/PA, PR/3/PA/ZB		PR/3/PP, PR/3/PP/ZB, PR/3/PA, PR/3/PA/ZB		PR/3/PP, PR/3/PP/ZB, PR/3/PA, PR/3/PA/ZB	
Marking tag	—		—		—	
Spare part relay	8904073		8904073		8904073	
End section	—		—		—	
Plugin jumper	—		—		—	

ELECTROMECHANICAL RELAY MODULES MULTI-CHANNEL WITH FUSES



- Pluggable relay
- AC/DC input voltage
- SPDT contact
- Allow PNP and NPN command
- Contact protected by replaceable fuse



NOTE

Manufacturer and model of the relay is not binding, technical data are to be considered typical

[2] Fuses are not provided, they must be selected according to the load current. The max. value of 6.3 A is referred to the fuses holder capability according to EN 60127.

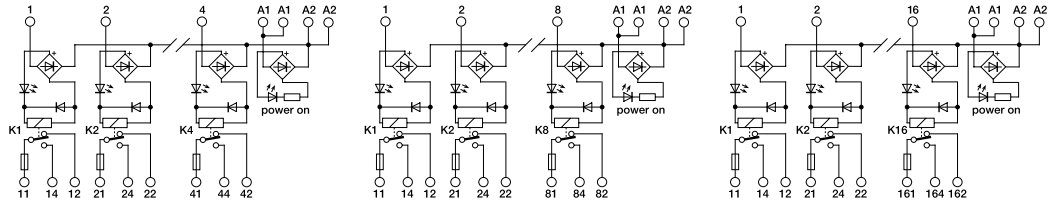

CODE TYPE	XR041U24F	XR081U24F	XR161U24F
INPUT TECHNICAL DATA			
Input rated voltage	24 Vac/dc ±10%	24 Vac/dc ±10%	24 Vac/dc ±10%
Pull in drop out voltage type	16.8 V / 2.4 V	16.8 V / 2.4 V	16.8 V / 2.4 V
Current consumption	22 mA ±10%	22 mA ±10%	22 mA ±10%
Turn ON OFF time	10 ms / 5 ms	10 ms / 5 ms	10 ms / 5 ms
Frequency	—	—	—
Protection circuit	Free-wheel diode, Reverse polarity	Free-wheel diode, Reverse polarity	Free-wheel diode, Reverse polarity
Connection type	2.5 mm ² screw type	2.5 mm ² screw type and 16 poles connector	2.5 mm ² screw type and 20 poles connector
Input channels	4 pluggable	8 pluggable	16 pluggable
OUTPUT TECHNICAL DATA			
Contact type	SPDT, 1 form C, AgSnO ₂	SPDT, 1 form C, AgSnO ₂	SPDT, 1 form C, AgSnO ₂
Output voltage	—	—	—
Nominal current	16 A (250 Vac)	16 A (250 Vac)	16 A (250 Vac)
Max current	16 A	16 A	16 A
Leakage current with signal 0	—	—	—
Min applicable load	—	—	—
Max fuse current	6.3 A (250 Vac) [2]	6.3 A (250 Vac) [2]	6.3 A (250 Vac) [2]
Connection type	2.5 mm ² (AWG26-14), screw type	2.5 mm ² (AWG26-14), screw type	2.5 mm ² (AWG26-14), screw type
Protection circuit device	—	—	—
GENERAL TECHNICAL DATA			
Operating temperature range	-20...+70°C	-20...+70°C	-20...+70°C
Input output isolation	2.5 kVac / 60 s	2.5 kVac / 60 s	2.5 kVac / 60 s
Protection degree	IP 00	IP 00	IP 00
Reference Standards	—	—	—
Overvoltage category pollution degree	II / 2	II / 2	II / 2
Status indication	LED "DC OK" / LED "Relay"	LED "DC OK" / LED "Relay"	LED "DC OK" / LED "Relay"
Housing material	UL94V-0 plastic material	UL94V-0 plastic material	UL94V-0 plastic material
Dimensions	70x93x75 mm	137x93x75 mm	250x93x75 mm
Approximate weight	210 g	326 g	770 g
Mounting information	on a rail, side by side	on a rail, side by side	on a rail, side by side
APPROVALS	CE	CE	CE
ACCESSORIES			
Mounting rail IEC60715 TH35 75	PR/3/AC, PR/3/AC/ZB, PR/3/AS, PR/3/AS/ZB	PR/3/AC, PR/3/AC/ZB, PR/3/AS, PR/3/AS/ZB	PR/3/AC, PR/3/AC/ZB, PR/3/AS, PR/3/AS/ZB
Mounting rail IEC60715 TH35 15	PR/3/PP, PR/3/PP/ZB, PR/3/PA, PR/3/PA/ZB	PR/3/PP, PR/3/PP/ZB, PR/3/PA, PR/3/PA/ZB	PR/3/PP, PR/3/PP/ZB, PR/3/PA, PR/3/PA/ZB
Marking tag	—	—	—
Spare part relay	8904073	8904073	8904073
End section	—	—	—
Plugin jumper	—	—	—

ELECTROMECHANICAL RELAY MODULES MULTI-CHANNEL



- Pluggable relay
- DC input voltage
- DPDT contact
- Coils with negative common and positive command (PNP)



NOTE

Manufacturer and model of the relay is not binding, technical data are to be considered typical

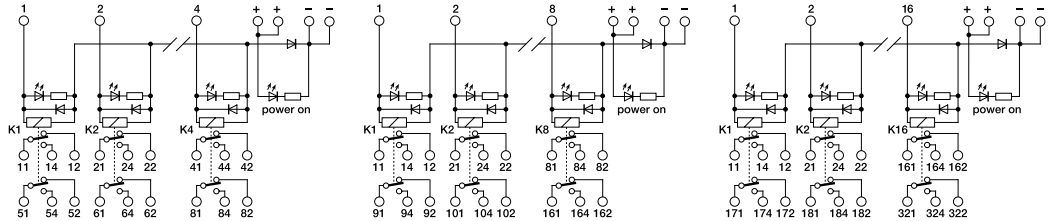

CODE TYPE	R42E24	XR042E24	R82E24	XR082E24	R162E24	XR162E24
INPUT TECHNICAL DATA						
Input rated voltage	24 Vdc ±10%		24 Vdc ±10%		24 Vdc ±10%	
Pull in drop out voltage type	16.8 V / 2.4 V		16.8 V / 2.4 V		16.8 V / 2.4 V	
Current consumption	22 mA ±10%		22 mA ±10%		22 mA ±10%	
Turn ON OFF time	10 ms / 5 ms		10 ms / 5 ms		10 ms / 5 ms	
Frequency	—		—		—	
Protection circuit	Free-wheel diode, Reverse polarity		Free-wheel diode, Reverse polarity		Free-wheel diode, Reverse polarity	
Connection type	2.5 mm ² screw type		2.5 mm ² screw type and 16 poles connector		2.5 mm ² screw type and 20 poles connector	
Input channels	4 pluggable		8 pluggable		16 pluggable	
OUTPUT TECHNICAL DATA						
Contact type	DPDT, 2 form C, AgSnO ₂		DPDT, 2 form C, AgSnO ₂		DPDT, 2 form C, AgSnO ₂	
Output voltage	—		—		—	
Nominal current	10 A (250 Vac)		10 A (250 Vac)		10 A (250 Vac)	
Max current	10 A		10 A		10 A	
Leakage current with signal 0	—		—		—	
Min applicable load	—		—		—	
Max fuse current	—		—		—	
Connection type	2.5 mm ² (AWG26-14), screw type		2.5 mm ² (AWG26-14), screw type		2.5 mm ² (AWG26-14), screw type	
Protection circuit device	—		—		—	
GENERAL TECHNICAL DATA						
Operating temperature range	-20...+70°C		-20...+70°C		-20...+70°C	
Input output isolation	2.5 kVac / 60 s		2.5 kVac / 60 s		2.5 kVac / 60 s	
Protection degree	IP 00		IP 00		IP 00	
Reference Standards	—		—		—	
Overvoltage category pollution degree	II / 2		II / 2		II / 2	
Status indication	LED "DC OK" / LED "Relay"		LED "DC OK" / LED "Relay"		LED "DC OK" / LED "Relay"	
Housing material	UL94V-0 plastic material		UL94V-0 plastic material		UL94V-0 plastic material	
Dimensions	70x93x75 mm		137x93x75 mm		250x93x75 mm	
Approximate weight	225 g		419 g		811 g	
Mounting information	on a rail, side by side		on a rail, side by side		on a rail, side by side	
APPROVALS	CE		CE		CE	
ACCESSORIES						
Mounting rail IEC60715 TH35 75	PR/3/AC, PR/3/AC/ZB, PR/3/AS, PR/3/AS/ZB		PR/3/AC, PR/3/AC/ZB, PR/3/AS, PR/3/AS/ZB		PR/3/AC, PR/3/AC/ZB, PR/3/AS, PR/3/AS/ZB	
Mounting rail IEC60715 TH35 15	PR/3/PP, PR/3/PP/ZB, PR/3/PA, PR/3/PA/ZB		PR/3/PP, PR/3/PP/ZB, PR/3/PA, PR/3/PA/ZB		PR/3/PP, PR/3/PP/ZB, PR/3/PA, PR/3/PA/ZB	
Marking tag	—		—		—	
Spare part relay	8904074		8904074		8904074	
End section	—		—		—	
Plugin jumper	—		—		—	

ELECTROMECHANICAL RELAY MODULES MULTI-CHANNEL



- Pluggable relay
- AC/DC input voltage
- DPDT contact
- Allow PNP and NPN command



NOTE

Manufacturer and model of the relay is not binding, technical data are to be considered typical

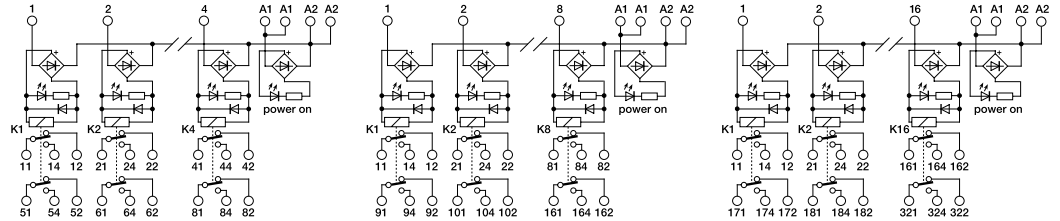

CODE TYPE	R42EAD	XR042EAD	R82EAD	XR082EAD	R162EAD	XR162EAD
INPUT TECHNICAL DATA						
Input rated voltage	24 Vac/dc ±10%		24 Vac/dc ±10%		24 Vac/dc ±10%	
Pull in drop out voltage type	16.8 V / 2.4 V		16.8 V / 2.4 V		16.8 V / 2.4 V	
Current consumption	22 mA ±10%		22 mA ±10%		22 mA ±10%	
Turn ON OFF time	10 ms / 5 ms		10 ms / 5 ms		10 ms / 5 ms	
Frequency	—		—		—	
Protection circuit	Free-wheel diode, Reverse polarity		Free-wheel diode, Reverse polarity		Free-wheel diode, Reverse polarity	
Connection type	2.5 mm ² screw type		2.5 mm ² screw type and 16 poles connector		2.5 mm ² screw type and 20 poles connector	
Input channels	4 pluggable		8 pluggable		16 pluggable	
OUTPUT TECHNICAL DATA						
Contact type	DPDT, 2 form C, AgSnO ₂		DPDT, 2 form C, AgSnO ₂		DPDT, 2 form C, AgSnO ₂	
Output voltage	—		—		—	
Nominal current	10 A (250 Vac)		10 A (250 Vac)		10 A (250 Vac)	
Max current	10 A		10 A		10 A	
Leakage current with signal 0	—		—		—	
Min applicable load	—		—		—	
Max fuse current	—		—		—	
Connection type	2.5 mm ² (AWG26-14), screw type		2.5 mm ² (AWG26-14), screw type		2.5 mm ² (AWG26-14), screw type	
Protection circuit device	—		—		—	
GENERAL TECHNICAL DATA						
Operating temperature range	-20...+70°C		-20...+70°C		-20...+70°C	
Input output isolation	2.5 kVac / 60 s		2.5 kVac / 60 s		2.5 kVac / 60 s	
Protection degree	IP 00		IP 00		IP 00	
Reference Standards	—		—		—	
Overvoltage category pollution degree	II / 2		II / 2		II / 2	
Status indication	LED "DC OK" / LED "Relay"		LED "DC OK" / LED "Relay"		LED "DC OK" / LED "Relay"	
Housing material	UL94V-0 plastic material		UL94V-0 plastic material		UL94V-0 plastic material	
Dimensions	70x93x75 mm		137x93x75 mm		250x93x75 mm	
Approximate weight	227 g		427 g		835 g	
Mounting information	on a rail, side by side		on a rail, side by side		on a rail, side by side	
APPROVALS	CE		CE		CE	
ACCESSORIES						
Mounting rail IEC60715 TH35 75	PR/3/AC, PR/3/AC/ZB, PR/3/AS, PR/3/AS/ZB		PR/3/AC, PR/3/AC/ZB, PR/3/AS, PR/3/AS/ZB		PR/3/AC, PR/3/AC/ZB, PR/3/AS, PR/3/AS/ZB	
Mounting rail IEC60715 TH35 15	PR/3/PP, PR/3/PP/ZB, PR/3/PA, PR/3/PA/ZB		PR/3/PP, PR/3/PP/ZB, PR/3/PA, PR/3/PA/ZB		PR/3/PP, PR/3/PP/ZB, PR/3/PA, PR/3/PA/ZB	
Marking tag	—		—		—	
Spare part relay	8904074		8904074		8904074	
End section	—		—		—	
Plugin jumper	—		—		—	

- Pluggable relay
- AC/DC input voltage
- SPDT contact
- Allow PNP and NPN command
- Test with buttons and switches



NOTE

Manufacturer and model of the relay is not binding, technical data are to be considered typical

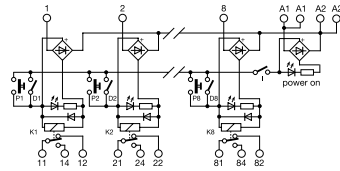

CODE TYPE	RMP081CM	XRMP081CM
INPUT TECHNICAL DATA		
Input rated voltage	24 Vac/dc ±10%	
Pull in/drop out voltage type	16.8 V / 2.4 V	
Current consumption	22 mA ±10%	
Turn ON/OFF time	10 ms / 5 ms	
Frequency	—	
Protection circuit	Free-wheel diode, Reverse polarity	
Connection type	2.5 mm ² screw type	
Input channels	8 pluggable	
OUTPUT TECHNICAL DATA		
Contact type	SPDT, 1 form C, AgSnO ₂	
Output voltage	—	
Nominal current	16 A (250 Vac)	
Max current	16 A	
Leakage current with signal 0	—	
Min applicable load	—	
Max fuse current	—	
Connection type	2.5 mm ² (AWG26-14), screw type	
Protection circuit device	—	
GENERAL TECHNICAL DATA		
Operating temperature range	-20...+70°C	
Input output isolation	2.5 kVac / 60 s	
Protection degree	IP 00	
Reference Standards	—	
Overvoltage category/pollution degree	II / 2	
Status indication	LED "DC OK" / LED "Relay"	
Housing material	UL94V-0 plastic material	
Dimensions	136x93x75 mm	
Approximate weight	350 g	
Mounting information	on a rail, side by side	
APPROVALS		
ACCESSORIES		
Mounting rail IEC60715 TH35 75	PR/3/AC, PR/3/AC/ZB, PR/3/AS, PR/3/AS/ZB	
Mounting rail IEC60715 TH35 15	PR/3/PP, PR/3/PP/ZB, PR/3/PA, PR/3/PA/ZB	
Marking tag	—	
Spare part relay	8904073	
End section	—	
Plugin jumper	—	
	—	
	—	
	—	
	—	

- P = test button
- D = DIP-switch
- IG = general switch for isolating buttons and the DIP-switch

This product can be operated in alternate current (AC) and also in direct current (DC). Relay activation can be forced temporarily using the relevant button, or permanently using a DIP-switch.

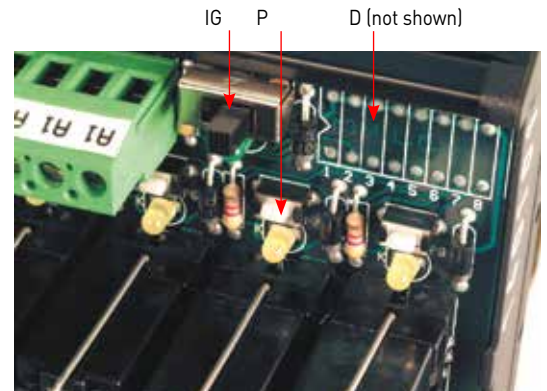

- Not-pluggable relay
- AC/DC input voltage
- Fast cabling with pluggable terminal blocks
- Allow PNP and NPN command
- Extremely compact dimensions

NOTE
Manufacturer and model of the relay is not binding, technical data are to be considered typical

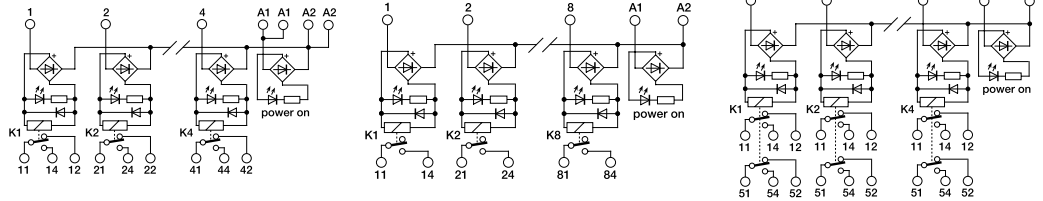

CODE TYPE	XCR41	XCR81	XCR42SC
INPUT TECHNICAL DATA			
Input rated voltage	24 Vac/dc ±10%	24 Vac/dc ±10%	24 Vac/dc ±10%
Pull in drop out voltage type	16.8 V / 2.4 V	16.8 V / 2.4 V	33.6 V / 4.8 V
Current consumption	16 mA ±10%	16 mA ±10%	20 mA ±10%
Turn ON OFF time	7 ms / 3 ms	7 ms / 3 ms	10 ms / 15 ms
Frequency	—	—	—
Protection circuit	Free-wheel diode, Reverse polarity	Free-wheel diode, Reverse polarity	Free-wheel diode, Reverse polarity
Connection type	2.5 mm ² screw type pluggable	2.5 mm ² screw type pluggable	2.5 mm ² screw type pluggable
Input channels	4 not pluggable	8 not pluggable	4 not pluggable
OUTPUT TECHNICAL DATA			
Contact type	SPDT, 1 form C, AgNi	SPST(NO), 1 Form A (NO), AgSnO ₂	DPDT, 2 form C, AgNi
Output voltage	—	—	—
Nominal current	8 A (240 Vac)	8 A (240 Vac)	8 A (250 Vac)
Max current	8 A	8 A	8 A
Leakage current with signal 0	—	—	—
Min applicable load	—	—	—
Max fuse current	—	—	—
Connection type	2.5 mm ² (AWG26-14), screw type pluggable	2.5 mm ² (AWG26-14), screw type pluggable	2.5 mm ² (AWG26-14), screw type pluggable
Protection circuit device	—	—	—
GENERAL TECHNICAL DATA			
Operating temperature range	-20...+70°C	-20...+70°C	-20...+60°C
Input output isolation	2.5 kVac / 60 s	2.5 kVac / 60 s	2.5 kVac / 60 s
Protection degree	IP 20	IP 20	IP 20
Reference Standards	—	—	—
Overvoltage category pollution degree	II / 2	II / 2	II / 2
Status indication	LED "DC OK" / LED "Relay"	LED "DC OK" / LED "Relay"	LED "DC OK" / LED "Relay"
Housing material	UL94V-0 plastic material	UL94V-0 plastic material	UL94V-0 plastic material
Dimensions	119x108x22.5 mm	119x108x22.5 mm	119x108x22.5 mm
Approximate weight	143 g	199 g	137 g
Mounting information	on a rail, side by side	on a rail, side by side	on a rail, side by side
APPROVALS	CE	CE	CE
ACCESSORIES			
Mounting rail IEC60715 TH35 75	PR/3/AC, PR/3/AC/ZB, PR/3/AS, PR/3/AS/ZB	PR/3/AC, PR/3/AC/ZB, PR/3/AS, PR/3/AS/ZB	PR/3/AC, PR/3/AC/ZB, PR/3/AS, PR/3/AS/ZB
Mounting rail IEC60715 TH35 15	—	—	—
Marking tag	—	—	—
Spare part relay	8904042	8904042	8904052
End section	—	—	—
Plugin jumper	—	—	—

- Pluggable relay
- AC/DC input voltage
- Fast cabling with pluggable terminal blocks
- Allow PNP and NPN command
- Extremely compact dimensions

NOTE

Manufacturer and model of the relay is not binding, technical data are to be considered typical

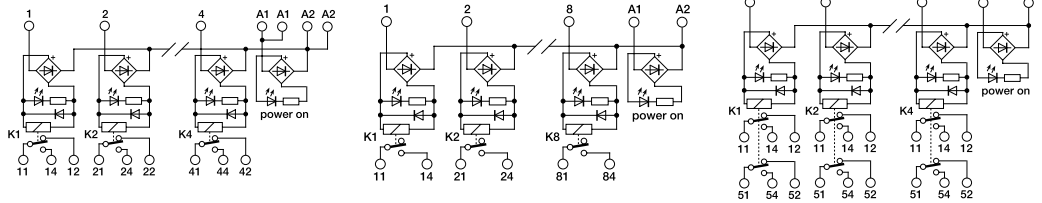

CODE TYPE	XCRE41	XCRE81	XCRE4-2SC
INPUT TECHNICAL DATA	CRE4-1	CRE8-1	CRE4-2SC
Input rated voltage	24 Vac/dc ±10%	24 Vac/dc ±10%	24 Vac/dc ±10%
Pull in drop out voltage type	16.8 V / 2.4 V	16.8 V / 2.4 V	33.6 V / 4.8 V
Current consumption	16 mA ±10%	16 mA ±10%	20 mA ±10%
Turn ON OFF time	7 ms / 3 ms	7 ms / 3 ms	10 ms / 15 ms
Frequency	—	—	—
Protection circuit	Free-wheel diode, Reverse polarity	Free-wheel diode, Reverse polarity	Free-wheel diode, Reverse polarity
Connection type	2.5 mm ² screw type pluggable	2.5 mm ² screw type pluggable	2.5 mm ² screw type pluggable
Input channels	4 pluggable	8 pluggable	4 pluggable
OUTPUT TECHNICAL DATA			
Contact type	SPDT, 1 form C, AgNi	SPST(NO), 1 Form A (NO), AgSnO2	DPDT, 2 form C, AgNi
Output voltage	—	—	—
Nominal current	8 A (240 Vac)	8 A (240 Vac)	8 A (250 Vac)
Max current	8 A	8 A	8 A
Leakage current with signal 0	—	—	—
Min applicable load	—	—	—
Max fuse current	—	—	—
Connection type	2.5 mm ² (AWG26-14), screw type pluggable	2.5 mm ² (AWG26-14), screw type pluggable	2.5 mm ² (AWG26-14), screw type pluggable
Protection circuit device	—	—	—
GENERAL TECHNICAL DATA			
Operating temperature range	-20...+70°C	-20...+70°C	-20...+60°C
Input output isolation	2.5 kVac / 60 s	2.5 kVac / 60 s	2.5 kVac / 60 s
Protection degree	IP 20	IP 20	IP 20
Reference Standards	—	—	—
Overvoltage category pollution degree	II / 2	II / 2	II / 2
Status indication	LED "DC OK" / LED "Relay"	LED "DC OK" / LED "Relay"	LED "DC OK" / LED "Relay"
Housing material	UL94V-0 plastic material	UL94V-0 plastic material	UL94V-0 plastic material
Dimensions	119x108x35 mm	119x108x35 mm	119x108x35 mm
Approximate weight	180 g	250 g	180 g
Mounting information	on a rail, side by side	on a rail, side by side	on a rail, side by side
APPROVALS	CE	CE	CE
ACCESSORIES			
Mounting rail IEC60715 TH35 75	PR/3/AC, PR/3/AC/ZB, PR/3/AS, PR/3/AS/ZB	PR/3/AC, PR/3/AC/ZB, PR/3/AS, PR/3/AS/ZB	PR/3/AC, PR/3/AC/ZB, PR/3/AS, PR/3/AS/ZB
Mounting rail IEC60715 TH35 15	—	—	—
Marking tag	—	—	—
Spare part relay	8904042	8904042	8904052
End section	—	—	—
Plugin jumper	—	—	—

- Pluggable relay (CRE) and not pluggable (CR)
- AC/DC input voltage
- Fast cabling with pluggable terminal blocks
- Allow PNP and NPN command
- Extremely compact dimensions

NOTE

Manufacturer and model of the relay is not binding, technical data are to be considered typical

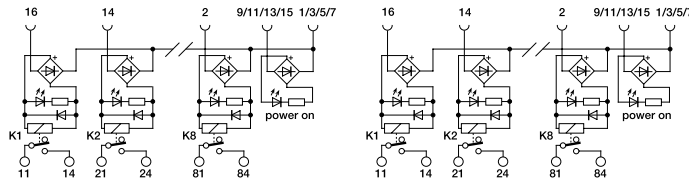

CODE TYPE	XCRE83	XCR83
INPUT TECHNICAL DATA	CRE8-3	CR8-3
Input rated voltage	24 Vac/dc ±10%	24 Vac/dc ±10%
Pull in/drop out voltage type	16.8 V / 2.4 V	16.8 V / 2.4 V
Current consumption	16 mA ±10%	16 mA ±10%
Turn ON/OFF time	15 ms / 5 ms	15 ms / 5 ms
Frequency	—	—
Protection circuit	Free-wheel diode, Reverse polarity	Free-wheel diode, Reverse polarity
Connection type	2.5 mm ² screw type pluggable	2.5 mm ² screw type pluggable
Input channels	8 pluggable	8 not pluggable
OUTPUT TECHNICAL DATA		
Contact type	SPST(NO), 1 Form A (NO), AgSnO ₂	SPST(NO), 1 Form A (NO), AgSnO ₂
Output voltage	—	—
Nominal current	8 A (240 Vac)	8 A (240 Vac)
Max current	8 A	8 A
Leakage current with signal 0	—	—
Min applicable load	—	—
Max fuse current	—	—
Connection type	2.5 mm ² (AWG26-14), screw type pluggable	2.5 mm ² (AWG26-14), screw type pluggable
Protection circuit device	—	—
GENERAL TECHNICAL DATA		
Operating temperature range	-20...+70°C	-20...+70°C
Input output isolation	2.5 kVac / 60 s	2.5 kVac / 60 s
Protection degree	IP 20	IP 20
Reference Standards	—	—
Overvoltage category/pollution degree	II / 2	II / 2
Status indication	LED "DC OK" / LED "Relay"	LED "DC OK" / LED "Relay"
Housing material	UL94V-0 plastic material	UL94V-0 plastic material
Dimensions	119x108x35 mm	119x108x22.5 mm
Approximate weight	199 g	199 g
Mounting information	on a rail, side by side	on a rail, side by side
APPROVALS	CE	CE
ACCESSORIES		
Mounting rail IEC60715 TH35 75	PR/3/AC, PR/3/AC/ZB, PR/3/AS, PR/3/AS/ZB	PR/3/AC, PR/3/AC/ZB, PR/3/AS, PR/3/AS/ZB
Mounting rail IEC60715 TH35 15	—	—
Marking tag	—	—
Spare part relay	8904042	8904042
End section	—	—
Plugin jumper	—	—

RELAY

SSR

Solid state relay

Multiple horizontal grey bars for taking notes.

SOLID STATE RELAY QUICK SELECTION TABLE



INPUT CHANNELS	INPUT RATED VOLTAGE	CONTACT TYPE	NOMINAL CURRENT (RESISTIVE LOAD)	PLUGGABLE RELAY	NOT PLUGGABLE RELAY	POSITIVE CONTROL (PNP)	NEGATIVE CONTROL (NPN)	PROTECTION CIRCUIT	CODE	TYPE	PAGE
1	5-12-24 Vdc	transistor	3 A	-	•	-	-	•	XO332060	O332060	144
1	5-12-24 Vdc	zero crossing triac	4 A	-	•	-	-	—	XO332240	O332240	144
1	24 Vdc	transistor	2 A	•	-	-	-	—	XCM1S024	CM1S024	145
1	12-24 Vdc	mosfet	5 A	•	-	-	-	•	XCM1S024E	CM1S024E	145
1	24 Vdc	zero crossing triac	3 A	•	-	-	-	—	XCM1T024	CM1T024	146
1	12-24 Vdc	zero crossing triac	3 A	•	-	-	-	•	XCM1T024E	CM1T024E	146
1	24 Vdc	transistor	10...500 mA	-	•	-	-	•	X766083	CWOT 6-2083	149
1	5-12-24 Vdc	transistor	80 mA	-	•	-	-	—	XCKS1S	CKS1S	149
1	5-12-24 Vdc	mosfet	10...500 mA	-	•	-	-	—	X766082	CWOT 6-6082	149
4	24 Vdc	transistor	2 A	•	-	•	•	—	XR042S24	R42S24	150
8	24 Vdc	transistor	2 A	•	-	•	•	—	XR082S24	R82S24	150
16	24 Vdc	transistor	2 A	•	-	•	•	—	XR162S24	R162S24	150
4	24 Vdc	zero crossing triac	3 A	•	-	•	•	—	XR042T24	R42T24	151
8	24 Vdc	zero crossing triac	3 A	•	-	•	•	—	XR082T24	R82T24	151
16	24 Vdc	zero crossing triac	3 A	•	-	•	•	—	XR162T24	R162T24	151
4	24 Vdc	transistor	2 A	•	-	•	•	—	XR041S24F	R41S24F	152
8	24 Vdc	transistor	2 A	•	-	•	•	—	XR081S24F	R81S24F	152
16	24 Vdc	transistor	2 A	•	-	•	•	—	XR161S24F	R161S24F	152
1	5-12-24 Vdc	mosfet	3 A / 5 A	-	•			•	XCKS024DC024DC03	CKS-024DC/024DC/03	147
1	5-12-24 Vdc	mosfet	8 A / 5 A	-	•			•	XCKS024DC024DC05	CKS-024DC/024DC/05	147
1	5-12-24 Vdc	mosfet	10 A / 15 A	-	•			•	XCKS024DC024DC10	CKS-024DC/024DC/10	147
1	12-24 Vac/dc	zero crossing triac	5 A	-	•			•	XCKS024DC230AC05	CKS-024DC/230AC/05	148

SOLID STATE RELAY MODULES SINGLE CHANNEL



- Not-pluggable relay
- Compact dimension

NOTE

Manufacturer and model of the relay is not binding, technical data are to be considered typical

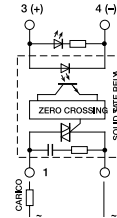
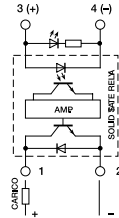
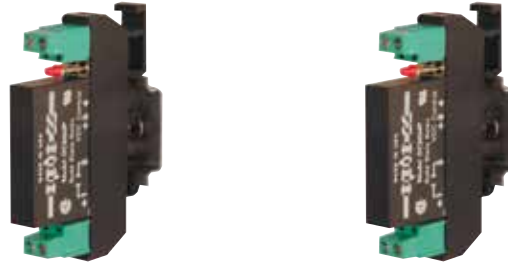

CODE	X0332060	X0332240
TYPE	0332060	0332240
INPUT TECHNICAL DATA		
Input rated voltage	5-12-24 Vdc (range 4...30 Vdc)	5-12-24 Vdc (range 4...30 Vdc)
Pull indrop out voltage type	3 V / 1 V	4 V / 0.8 V
Current consumption	35 mA ±10%	35 mA ±10%
Turn ON OFF time	200 µs / 800 µs	10 ms / 10 ms max.
Frequency	0...500 Hz	10...440 Hz
Protection circuit	Free-wheel diode	—
Connection type	2.5 mm ² screw type	2.5 mm ² screw type
Input channels	1 not pluggable	1 not pluggable
OUTPUT TECHNICAL DATA		
Contact type	transistor	zero crossing triac
Output voltage	5...60 Vdc	12...240 Vac
Nominal current	3 A (24 Vdc) at 20°C	4 A (230 Vac) at 20°C
Max current	10 A for 10 ms	100 A for 10 ms
Leakage current with signal 0	1 mA	2 mA
Min applicable load	—	—
Max fuse current	—	—
Connection type	2.5 mm ² (AWG26-14), screw type	2.5 mm ² (AWG26-14), screw type
Protection circuit device	free-wheel diode	varistor
GENERAL TECHNICAL DATA		
Operating temperature range	-20...+70°C (derating -0.5 W/°C over 20°C)	-20...+70°C (derating -1.2 W/°C over 30°C)
Input output isolation	2.5 kVac / 60 s	4 kVac / 60 s
Protection degree	IP 00	IP 00
Reference Standards	—	—
Overvoltage category pollution degree	II / 2	II / 2
Status indication	LED "Input"	LED "Input"
Housing material	UL94V-0 plastic material	UL94V-0 plastic material
Dimensions	12x77x54 mm	12x77x54 mm
Approximate weight	36 g	36 g
Mounting information	vertical on a rail, 5 mm from adjacent components	vertical on a rail, 5 mm from adjacent components
APPROVALS	CE	CE
ACCESSORIES		
Mounting rail IEC60715 TH35 75	PR/3/AC, PR/3/AC/ZB, PR/3/AS, PR/3/AS/ZB	PR/3/AC, PR/3/AC/ZB, PR/3/AS, PR/3/AS/ZB
Mounting rail IEC60715 TH35 15	PR/3/PP, PR/3/PP/ZB, PR/3/PA, PR/3/PA/ZB	PR/3/PP, PR/3/PP/ZB, PR/3/PA, PR/3/PA/ZB
Marking tag	—	—
Spare part relay	—	—
End section	—	—
Plugin jumper	—	—

- Pluggable relay

NOTE

Manufacturer and model of the relay is not binding, technical data are to be considered typical

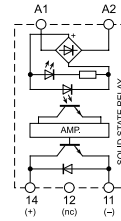
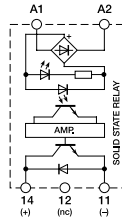

CODE	XCM1S024	XCM1S024E
TYPE	CM1S024	CM1S024E (1)
INPUT TECHNICAL DATA		
Input rated voltage	24 Vdc (range 19.5...28.5 Vdc)	12-24 Vdc (range 10...32 Vdc)
Pull in drop out voltage type	19.2 V / 1 V	10 V / 10 V
Current consumption	25 mA ±10% at 24 Vdc	16 mA ±10% at 24 Vdc
Turn ON OFF time	1 ms / 1 ms	50 µs / 250 µs
Frequency	100 Hz max	100 Hz max
Protection circuit	—	Free-wheel diode
Connection type	2.5 mm ² screw type	2.5 mm ² screw type
Input channels	1 pluggable	1 pluggable
OUTPUT TECHNICAL DATA		
Contact type	transistor	mosfet
Output voltage	3...50 Vdc	5...32 Vdc
Nominal current	2 A (24 Vdc) at 30°C	5 A (24 Vdc) at 60°C
Max current	8 A for 10 ms	120 A for 20 ms (peak)
Leakage current with signal 0	0.1 mA	10 µA
Min applicable load	10 mA	—
Max fuse current	—	—
Connection type	2.5 mm ² (AWG26-14), screw type	2.5 mm ² (AWG26-14), screw type
Protection circuit device	—	suppressor diode
GENERAL TECHNICAL DATA		
Operating temperature range	-20...+70°C (derating -0.75 W/°C over 30°C)	-20...+70°C (derating -0.1 A/°C over 60°C)
Input output isolation	2.5 kVac / 60 s	2.5 kVac / 60 s
Protection degree	IP 20	IP 20
Reference Standards	—	—
Overvoltage category pollution degree	II / 2	II / 2
Status indication	LED "Input"	LED "Input"
Housing material	UL94V-0 plastic material	UL94V-0 plastic material
Dimensions	16x75x68 mm	16x75x68 mm
Approximate weight	54 g	54 g
Mounting information	vertical on a rail, side by side	vertical on a rail, side by side
APPROVALS	CE	CE
ACCESSORIES		
Mounting rail IEC60715 TH35 75	PR/3/AC, PR/3/AC/ZB, PR/3/AS, PR/3/AS/ZB	PR/3/AC, PR/3/AC/ZB, PR/3/AS, PR/3/AS/ZB
Mounting rail IEC60715 TH35 15	—	—
Marking tag	already mounted	already mounted
Spare part relay	8904404	8904402
End section	—	—
Plugin jumper	CMB16B (8 poles) — — — — —	CMB16B (8 poles) — — — — —

- Pluggable relay

NOTE

Manufacturer and model of the relay is not binding, technical data are to be considered typical

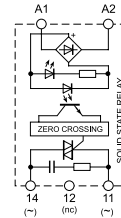
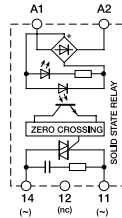

CODE	XCM1T024	XCM1T024E
TYPE	CM1T024	CM1T024E (1)
INPUT TECHNICAL DATA		
Input rated voltage	24 Vdc (range 19.5...28.5 Vdc)	12-24 Vdc (range 10...32 Vdc)
Pull in drop out voltage type	19.2 V / 1 V	10 V / 10 V
Current consumption	25 mA ±10% at 24 Vdc	17 mA ±10% at 24 Vdc
Turn ON OFF time	11 ms / 11 ms (at 50 Hz)	1/2 cycle / 1/2 cycle
Frequency	30...100 Hz max	100 Hz max
Protection circuit	—	Free-wheel diode
Connection type	2.5 mm ² screw type	2.5 mm ² screw type
Input channels	1 pluggable	1 pluggable
OUTPUT TECHNICAL DATA		
Contact type	zero crossing triac	zero crossing triac
Output voltage	48...280 Vac	12...275 Vac
Nominal current	3 A (24 Vdc) at 30°C	3 A (24 Vdc) at 60°C
Max current	120 A for 10 ms	120 A for 20 ms (peak)
Leakage current with signal 0	5 mA	1 mA
Min applicable load	—	—
Max fuse current	—	—
Connection type	2.5 mm ² (AWG26-14), screw type	2.5 mm ² (AWG26-14), screw type
Protection circuit device	—	—
GENERAL TECHNICAL DATA		
Operating temperature range	-20...+80°C (derating -0.05 A/°C over 30°C)	-20...+70°C (derating -0.03 A/°C over 40°C)
Input output isolation	2.5 kVac / 60 s	2.5 kVac / 60 s
Protection degree	IP 20	IP 20
Reference Standards	—	—
Overvoltage category pollution degree	II / 2	II / 2
Status indication	LED "Input"	LED "Input"
Housing material	UL94V-0 plastic material	UL94V-0 plastic material
Dimensions	16x75x68 mm	16x75x68 mm
Approximate weight	54 g	54 g
Mounting information	vertical on a rail, side by side	vertical on a rail, side by side
APPROVALS	CE	CE
ACCESSORIES		
Mounting rail IEC60715 TH35 75	PR/3/AC, PR/3/AC/ZB, PR/3/AS, PR/3/AS/ZB	PR/3/AC, PR/3/AC/ZB, PR/3/AS, PR/3/AS/ZB
Mounting rail IEC60715 TH35 15	—	—
Marking tag	already mounted	already mounted
Spare part relay	8904405	8904403
End section	—	—
Plugin jumper	CMB16B (8 poles)	CMB16B (8 poles)
	—	—
	—	—
	—	—
	—	—
	—	—

- Not-pluggable relay
- Protection against short circuit, overload, overtemperature
- Suitable for DC loads
- Compact dimension



NOTE

Manufacturer and model of the components is not binding, technical data are to be considered typical

(1) The maximum current depend on the number of actived output and the ambient temperature

(2) Protection switch off the output current and yellow LED. The output restart automatically when the overload is removed. The current limiting depending also by operating temperature, for more accuracy or to protect cables with a lower rated current, an external fuse must be provided.

(3) with the CK/PT end plate on the final module

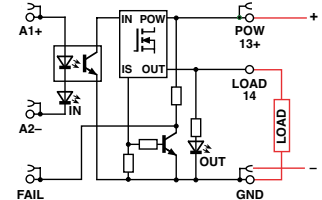
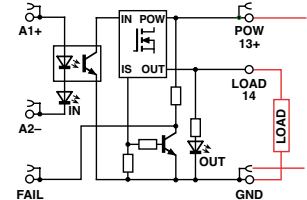
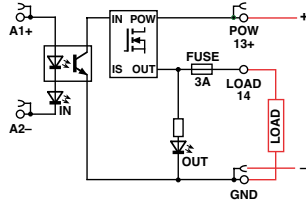

CODE	XCKS024DC024DC03	XCKS024DC024DC05	XCKS024DC024DC10
TYPE	CKS-024DC/024DC/03	CKS-024DC/024DC/05	CKS-024DC/024DC/10
INPUT TECHNICAL DATA			
Input rated voltage	5-12-24 Vdc (range 4.7...32 Vdc)	5-12-24 Vdc (range 4.7...32 Vdc)	5-12-24 Vdc (range 4.7...32 Vdc)
Pull in drop out voltage type	4.5 V / 4.2 V	4.5 V / 4.2 V	4.5 V / 4.2 V
Current consumption	10 mA ±10% at 24 Vdc	10 mA ±10% at 24 Vdc	10 mA ±10% at 24 Vdc
Turn ON OFF time	—	—	—
Frequency	200 Hz max.	200 Hz max.	200 Hz max.
Protection circuit	Free-wheel diode, Reverse polarity	Free-wheel diode, Reverse polarity	Free-wheel diode, Reverse polarity
Connection type	2.5 mm ² spring type	2.5 mm ² spring type	2.5 mm ² spring type
Input channels	1 not pluggable	1 not pluggable	1 not pluggable
OUTPUT TECHNICAL DATA			
Contact type	mosfet	mosfet	mosfet
Output voltage	5...32 Vdc	5...32 Vdc	5...32 Vdc
Nominal current	3 A (24 Vdc) at 45°C / 5 A (24 Vdc) at 20°C	8 A (24 Vdc) at 45°C / 5 A (24 Vdc) at 20°C	10 A (24 Vdc) at 45°C / 15 A (24 Vdc) at 20°C
Max current	5 A for 2 s ±10% at 25°C (1)	21 A for 100 ms at 25°C (1)	21 A for 100 ms at 25°C (1)
Leakage current with signal 0	< 25 µA at 24 Vdc	< 25 µA at 24 Vdc	< 25 µA at 24 Vdc
Min applicable load	10 mA / 5 V	10 mA / 5 V	10 mA / 5 V
Max fuse current	—	—	—
Connection type	2.5 mm ² (AWG26-14), spring type	2.5 mm ² (AWG26-14), spring type	2.5 mm ² (AWG26-14), spring type
Protection circuit device	suppressor diode / resettable fuse (2)	suppressor diode / short circuit, overload, overtemperature (2)	suppressor diode / short circuit, overload, overtemperature (2)
GENERAL TECHNICAL DATA			
Operating temperature range	-20...+60°C	-20...+60°C	-20...+60°C
Input output isolation	2.5 kVac / 60 s	2.5 kVac / 60 s	2.5 kVac / 60 s
Protection degree	IP 00 / IP20 (3)	IP 00 / IP20 (3)	IP 00 / IP20 (3)
Reference Standards	—	—	—
Overvoltage category pollution degree	II / 2	II / 2	II / 2
Status indication	LED "Input" / LED "Output-Fail"	LED "Input" / LED "Output-Fail"	LED "Input" / LED "Output-Fail"
Housing material	UL94V-0 plastic material	UL94V-0 plastic material	UL94V-0 plastic material
Dimensions	6x91x100 mm	6x91x100 mm	6x91x100 mm
Approximate weight	30 g	30 g	30 g
Mounting information	on a rail, side by side	on a rail, side by side	on a rail, side by side
APPROVALS	CE	CE	CE
ACCESSORIES			
Mounting rail IEC60715 TH35 75	PR/3/AC, PR/3/AC/ZB, PR/3/AS, PR/3/AS/ZB	PR/3/AC, PR/3/AC/ZB, PR/3/AS, PR/3/AS/ZB	PR/3/AC, PR/3/AC/ZB, PR/3/AS, PR/3/AS/ZB
Mounting rail IEC60715 TH35 15	—	—	—
Marking tag	NU0851	NU0851	NU0851
Spare part relay	—	—	—
End section	XCKPT	XCKPT	XCKPT
Plugin jumper	PTC/4/02 (2 poles) PTC/4/03 (3 poles) PTC/4/04 (4 poles) PTC/4/05 (5 poles) PTC/4/10 (10 poles) PTC/4/00 (42 poles)	PTC/4/02 (2 poles) PTC/4/03 (3 poles) PTC/4/04 (4 poles) PTC/4/05 (5 poles) PTC/4/10 (10 poles) PTC/4/00 (42 poles)	PTC/4/02 (2 poles) PTC/4/03 (3 poles) PTC/4/04 (4 poles) PTC/4/05 (5 poles) PTC/4/10 (10 poles) PTC/4/00 (42 poles)

- Not-pluggable relay
- Output overvoltage protection
- Suitable for AC loads
- Compact dimension



NOTE

Manufacturer and model of the components is not binding, technical data are to be considered typical

(1) The maximum current depend on the number of actived output and the ambient temperature

(2) An external protection fuse rated 5 A is required

(3) with the CK/PT end plate on the final module

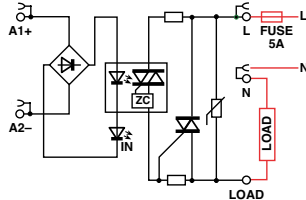

CODE	XCKS024DC230AC05
TYPE	CKS-024DC/230AC/05
INPUT TECHNICAL DATA	
Input rated voltage	12-24 Vac/dc (range 9...30 Vac/dc)
Pull indrop out voltage type	8.5 V / 8 V
Current consumption	10 mA ±10% at 24 Vdc
Turn ON OFF time	1/2 cycle / 1/2 cycle
Frequency	100 Hz max
Protection circuit	Free-wheel diode, Reverse polarity
Connection type	2.5 mm ² spring type
Input channels	1 not pluggable
OUTPUT TECHNICAL DATA	
Contact type	zero crossing triac
Output voltage	20...265 Vac
Nominal current	5 A (230 Vac) at 45°C
Max current	6 A (1)
Leakage current with signal 0	< 25 µA at 24 Vdc
Min applicable load	10 mA / 24 Vac
Max fuse current	—
Connection type	2.5 mm ² (AWG26-14), spring type
Protection circuit device	varistor (2)
GENERAL TECHNICAL DATA	
Operating temperature range	-20 ...+45°C
Input output isolation	2.5 kVac / 60 s
Protection degree	IP 00 / IP20 (3)
Reference Standards	—
Overvoltage category pollution degree	II / 2
Status indication	LED "Input"
Housing material	UL94V-0 plastic material
Dimensions	6x91x100 mm
Approximate weight	30 g
Mounting information	on a rail, side by side
APPROVALS	CE
ACCESSORIES	
Mounting rail IEC60715 TH35 75	PR/3/AC, PR/3/AC/ZB, PR/3/AS, PR/3/AS/ZB
Mounting rail IEC60715 TH35 15	—
Marking tag	NU0851
Spare part relay	—
End section	XCKPT
Plugin jumper	PTC/4/02 (2 poles) PTC/4/03 (3 poles) PTC/4/04 (4 poles) PTC/4/05 (5 poles) PTC/4/10 (10 poles) PTC/4/00 (42 poles)

SOLID STATE RELAY MODULES SINGLE CHANNEL



- Not-pluggable relay
- Simulated SPD output contact

NOTE
Manufacturer and model of the components is not binding, technical data are to be considered typical

[2] simulated SPD contact

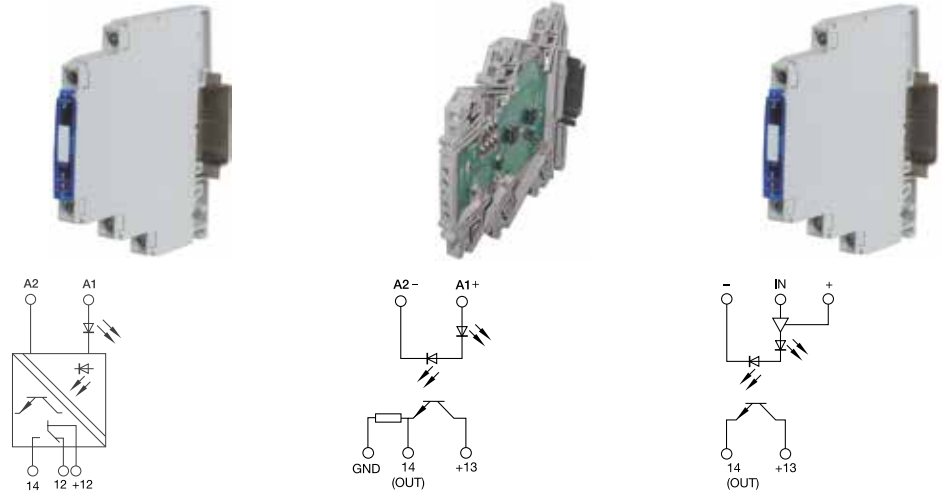

CODE	X766083	XCKS1S	X766082
TYPE	CWOT 6-2083 (1)	CKS1S (1)	CWOT 6-6082 (1)
INPUT TECHNICAL DATA			
Input rated voltage	24 Vdc (range 10...40 Vdc)	5-12-24 Vdc (range 4...30 Vdc)	5-12-24 Vdc (range 4.5...28 Vdc)
Pull in drop out voltage type	5 V / 5 V	3 V / 3 V	4.2 V / 2.7 V
Current consumption	6 mA ±10% at 24 Vdc	10 mA ±10% at 24 Vdc	0.1 mA ±10%
Turn ON OFF time	12 μs / 12 μs	—	12 μs / 12 μs
Frequency	1 KHz	20 kHz max duty cycle 50/50, 70/30 max	20 KHz
Protection circuit	Free-wheel diode	—	—
Connection type	2.5 mm ² screw type	2.5 mm ² spring type	2.5 mm ² screw type
Input channels	1 not pluggable	1 not pluggable	1 not pluggable
OUTPUT TECHNICAL DATA			
Contact type	transistor [2]	transistor	mosfet
Output voltage	5...48 Vdc	3...30 Vdc	5...48 Vdc
Nominal current	10...500 mA (24 Vdc)	80 mA (30 Vdc) at 25°C	10...500 mA (24 Vdc)
Max current	—	—	—
Leakage current with signal 0	—	—	—
Min applicable load	—	2 mA / 10 mV	—
Max fuse current	—	—	—
Connection type	2.5 mm ² (AWG26-14), screw type	2.5 mm ² (AWG26-14), spring type	2.5 mm ² (AWG26-14), screw type
Protection circuit device	suppressor diode	—	—
GENERAL TECHNICAL DATA			
Operating temperature range	-25...+60°C	-20...+60°C	-25...+60°C
Input output isolation	3.5 kVac / 60 s	3 kVac / 60 s	3.5 kVac / 60 s
Protection degree	IP 20	IP 00 / IP20 [3]	IP 20
Reference Standards	—	—	—
Overvoltage category pollution degree	II / 2	II / 2	II / 2
Status indication	LED "Input"	LED "Input"	LED "Input"
Housing material	UL94V-0 plastic material	UL94V-0 plastic material	UL94V-0 plastic material
Dimensions	84x79x6.2 mm	6x91x100 mm	6.2x79x84 mm
Approximate weight	29 g	32 g	29 g
Mounting information	on a rail, side by side	on a rail, side by side	on a rail, side by side
APPROVALS	CE	CE	CE
ACCESSORIES			
Mounting rail IEC60715 TH35 75	PR/3/AC, PR/3/AC/ZB, PR/3/AS, PR/3/AS/ZB	PR/3/AC, PR/3/AC/ZB, PR/3/AS, PR/3/AS/ZB	PR/3/AC, PR/3/AC/ZB, PR/3/AS, PR/3/AS/ZB
Mounting rail IEC60715 TH35 15	—	—	—
Marking tag	—	NU0851	—
Spare part relay	—	—	—
End section	—	XCKPT	—
Plugin jumper	—	PTC/4/02 (2 poles) PTC/4/03 (3 poles) PTC/4/04 (4 poles) PTC/4/05 (5 poles) PTC/4/10 (10 poles) PTC/4/00 (42 poles)	—

SOLID STATE RELAY MODULES MULTI-CHANNEL



- Pluggable relay
- Allow PNP and NPN command
- Suitable for DC loads



NOTE

Manufacturer and model of the relay is not binding, technical data are to be considered typical

(1) Version produced upon request; contact our sales office for availability.

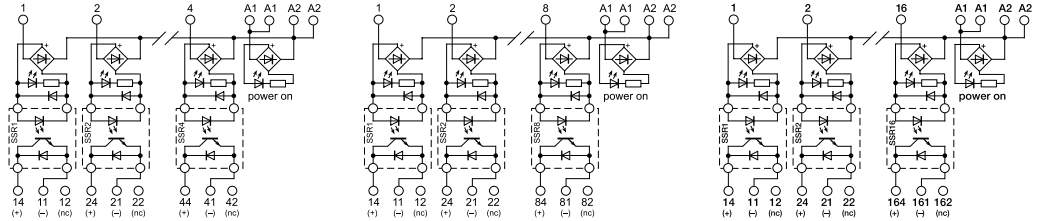

CODE	XR042S24	XR82S24	XR082S24	XR162S24
TYPE	R42S24 (1)	R82S24 (1)	R82S24 (1)	R162S24 (1)
INPUT TECHNICAL DATA				
Input rated voltage	24 Vdc (range 19.5...28.5 Vdc)	24 Vdc (range 19.5...28.5 Vdc)	24 Vdc (range 19.5...28.5 Vdc)	24 Vdc (range 19.5...28.5 Vdc)
Pull in drop out voltage type	19.2 V / 1 V	19.2 V / 1 V	19.2 V / 1 V	19.2 V / 1 V
Current consumption	25 mA ±10% at 24 Vdc	25 mA ±10% at 24 Vdc	25 mA ±10% at 24 Vdc	25 mA ±10% at 24 Vdc
Turn ON OFF time	1 ms / 1 ms	1 ms / 1 ms	1 ms / 1 ms	1 ms / 1 ms
Frequency	100 Hz max	100 Hz max	100 Hz max	100 Hz max
Protection circuit	—	—	—	—
Connection type	2.5 mm ² screw type	2.5 mm ² screw type	2.5 mm ² screw type	2.5 mm ² screw type
Input channels	4 pluggable	8 pluggable	8 pluggable	16 pluggable
OUTPUT TECHNICAL DATA				
Contact type	transistor	transistor	transistor	transistor
Output voltage	3...50 Vdc	3...50 Vdc	3...50 Vdc	3...50 Vdc
Nominal current	2 A (24 Vdc) at 30°C	2 A (24 Vdc) at 30°C	2 A (24 Vdc) at 30°C	2 A (24 Vdc) at 30°C
Max current	8 A for 10 ms	8 A for 10 ms	8 A for 10 ms	8 A for 10 ms
Leakage current with signal 0	0.1 mA	0.1 mA	0.1 mA	0.1 mA
Min applicable load	10 mA	10 mA	10 mA	10 mA
Max fuse current	—	—	—	—
Connection type	2.5 mm ² (AWG26-14), screw type	2.5 mm ² (AWG26-14), screw type	2.5 mm ² (AWG26-14), screw type	2.5 mm ² (AWG26-14), screw type
Protection circuit device	—	—	—	—
GENERAL TECHNICAL DATA				
Operating temperature range	-20...+70°C (derating -0.75 W/°C over 30°C)	-20...+70°C (derating -0.75 W/°C over 30°C)	-20...+70°C (derating -0.75 W/°C over 30°C)	-20...+70°C (derating -0.75 W/°C over 30°C)
Input output isolation	2.5 kVac / 60 s	2.5 kVac / 60 s	2.5 kVac / 60 s	2.5 kVac / 60 s
Protection degree	IP 00	IP 00	IP 00	IP 00
Reference Standards	—	—	—	—
Overvoltage category pollution degree	II / 2	II / 2	II / 2	II / 2
Status indication	LED "Input"	LED "Input"	LED "Input"	LED "Input"
Housing material	UL94V-0 plastic material	UL94V-0 plastic material	UL94V-0 plastic material	UL94V-0 plastic material
Dimensions	70x93x75 mm	137x93x75 mm	137x93x75 mm	250x93x75 mm
Approximate weight	207 g	379 g	379 g	756 g
Mounting information	vertical on a rail, side by side	vertical on a rail, side by side	vertical on a rail, side by side	vertical on a rail, side by side
APPROVALS	CE	CE	CE	CE
ACCESSORIES				
Mounting rail IEC60715 TH35 75	PR/3/AC, PR/3/AC/ZB, PR/3/AS, PR/3/AS/ZB	PR/3/AC, PR/3/AC/ZB, PR/3/AS, PR/3/AS/ZB	PR/3/AC, PR/3/AC/ZB, PR/3/AS, PR/3/AS/ZB	PR/3/AC, PR/3/AC/ZB, PR/3/AS, PR/3/AS/ZB
Mounting rail IEC60715 TH35 15	PR/3/PP, PR/3/PP/ZB, PR/3/PA, PR/3/PA/ZB	PR/3/PP, PR/3/PP/ZB, PR/3/PA, PR/3/PA/ZB	PR/3/PP, PR/3/PP/ZB, PR/3/PA, PR/3/PA/ZB	PR/3/PP, PR/3/PP/ZB, PR/3/PA, PR/3/PA/ZB
Marking tag	—	—	—	—
Spare part relay	8904404	8904404	8904404	8904404
End section	—	—	—	—
Plugin jumper	—	—	—	—

SOLID STATE RELAY MODULES MULTI-CHANNEL



- Pluggable relay
- Allow PNP and NPN command
- Suitable for AC loads



NOTE

Manufacturer and model of the relay is not binding, technical data are to be considered typical

[1] Version produced upon request; contact our sales office for availability.

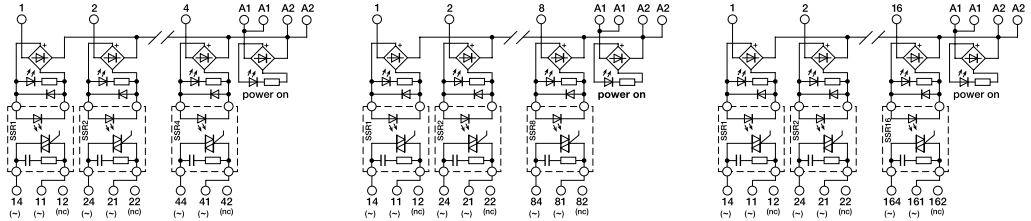

CODE	XR042T24	XR082T24	XR162T24
TYPE	R42T24 (1)	R82T24 (1)	R162T24 (1)
INPUT TECHNICAL DATA			
Input rated voltage	24 Vdc (range 19.5...28.5 Vdc)	24 Vdc (range 19.5...28.5 Vdc)	24 Vdc (range 19.5...28.5 Vdc)
Pull in drop out voltage type	19.2 V / 1 V	19.2 V / 1 V	19.2 V / 1 V
Current consumption	25 mA ±10% at 24 Vdc	25 mA ±10% at 24 Vdc	25 mA ±10% at 24 Vdc
Turn ON OFF time	11 ms / 11 ms (at 50 Hz)	11 ms / 11 ms (at 50 Hz)	11 ms / 11 ms (at 50 Hz)
Frequency	30...100 Hz max	30...100 Hz max	30...100 Hz max
Protection circuit	—	—	—
Connection type	2.5 mm ² screw type	2.5 mm ² screw type	2.5 mm ² screw type
Input channels	4 pluggable	8 pluggable	16 pluggable
OUTPUT TECHNICAL DATA			
Contact type	zero crossing triac	zero crossing triac	zero crossing triac
Output voltage	48...280 Vac	48...280 Vac	48...280 Vac
Nominal current	3 A (24 Vdc) at 30°C	3 A (24 Vdc) at 30°C	3 A (24 Vdc) at 30°C
Max current	120 A for 10 ms	120 A for 10 ms	120 A for 10 ms
Leakage current with signal 0	5 mA	5 mA	5 mA
Min applicable load	—	—	—
Max fuse current	—	—	—
Connection type	2.5 mm ² (AWG26-14), screw type	2.5 mm ² (AWG26-14), screw type	2.5 mm ² (AWG26-14), screw type
Protection circuit device	—	—	—
GENERAL TECHNICAL DATA			
Operating temperature range	-20...+80°C (derating -0.05 A/°C over 30°C)	-20...+80°C (derating -0.05 A/°C over 30°C)	-20...+80°C (derating -0.05 A/°C over 30°C)
Input output isolation	2.5 kVac / 60 s	2.5 kVac / 60 s	2.5 kVac / 60 s
Protection degree	IP 00	IP 00	IP 00
Reference Standards	—	—	—
Overvoltage category pollution degree	II / 2	II / 2	II / 2
Status indication	LED "Input"	LED "Input"	LED "Input"
Housing material	UL94V-0 plastic material	UL94V-0 plastic material	UL94V-0 plastic material
Dimensions	70x93x75 mm	137x93x75 mm	250x93x75 mm
Approximate weight	207 g	379 g	756 g
Mounting information	vertical on a rail, side by side	vertical on a rail, side by side	vertical on a rail, side by side
APPROVALS	CE	CE	CE
ACCESSORIES			
Mounting rail IEC60715 TH35 75	PR/3/AC, PR/3/AC/ZB, PR/3/AS, PR/3/AS/ZB	PR/3/AC, PR/3/AC/ZB, PR/3/AS, PR/3/AS/ZB	PR/3/AC, PR/3/AC/ZB, PR/3/AS, PR/3/AS/ZB
Mounting rail IEC60715 TH35 15	PR/3/PP, PR/3/PP/ZB, PR/3/PA, PR/3/PA/ZB	PR/3/PP, PR/3/PP/ZB, PR/3/PA, PR/3/PA/ZB	PR/3/PP, PR/3/PP/ZB, PR/3/PA, PR/3/PA/ZB
Marking tag	—	—	—
Spare part relay	8904405	8904405	8904405
End section	—	—	—
Plugin jumper	—	—	—

SOLID STATE RELAY MODULES MULTI-CHANNEL WITH FUSES



- Pluggable relay
- Allow PNP and NPN command
- Suitable for DC loads
- Contact protected by replaceable fuse



NOTE

Manufacturer and model of the relay is not binding, technical data are to be considered typical

(1) Version produced upon request; contact our sales office for availability.

(2) Fuses are not provided, they must be selected according to the load current. The max. value of 6.3 A is referred to the fuses holder capability according to EN 60127.

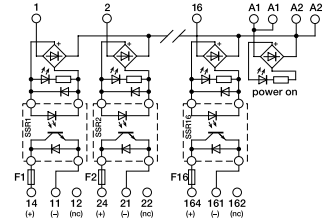
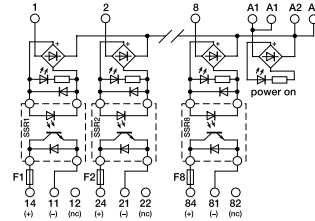
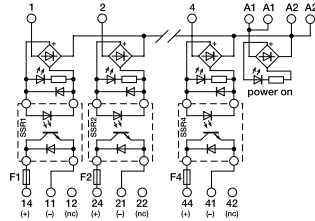

CODE	XR041S24F	XR081S24F	XR161S24F
TYPE	R41S24F (1)	R81S24F (1)	R161S24F (1)
INPUT TECHNICAL DATA			
Input rated voltage	24 Vdc (range 19.5...28.5 Vdc)	24 Vdc (range 19.5...28.5 Vdc)	24 Vdc (range 19.5...28.5 Vdc)
Pull in drop out voltage type	19.2 V / 1 V	19.2 V / 1 V	19.2 V / 1 V
Current consumption	25 mA ±10% at 24 Vdc	25 mA ±10% at 24 Vdc	25 mA ±10% at 24 Vdc
Turn ON OFF time	1 ms / 1 ms	1 ms / 1 ms	1 ms / 1 ms
Frequency	100 Hz max	100 Hz max	100 Hz max
Protection circuit	—	—	—
Connection type	2.5 mm ² screw type	2.5 mm ² screw type	2.5 mm ² screw type
Input channels	4 pluggable	8 pluggable	16 pluggable
OUTPUT TECHNICAL DATA			
Contact type	transistor	transistor	transistor
Output voltage	3...50 Vdc	3...50 Vdc	3...50 Vdc
Nominal current	2 A (24 Vdc) at 30°C	2 A (24 Vdc) at 30°C	2 A (24 Vdc) at 30°C
Max current	8 A for 10 ms	8 A for 10 ms	8 A for 10 ms
Leakage current with signal 0	0.1 mA	0.1 mA	0.1 mA
Min applicable load	10 mA	10 mA	10 mA
Max fuse current	6.3 A (250 Vac) [2]	6.3 A (250 Vac) [2]	6.3 A (250 Vac) [2]
Connection type	2.5 mm ² (AWG26-14), screw type	2.5 mm ² (AWG26-14), screw type	2.5 mm ² (AWG26-14), screw type
Protection circuit device	—	—	—
GENERAL TECHNICAL DATA			
Operating temperature range	-20...+70°C (derating -0.75 W/°C over 30°C)	-20...+70°C (derating -0.75 W/°C over 30°C)	-20...+70°C (derating -0.75 W/°C over 30°C)
Input output isolation	2.5 kVac / 60 s	2.5 kVac / 60 s	2.5 kVac / 60 s
Protection degree	IP 00	IP 00	IP 00
Reference Standards	—	—	—
Overvoltage category pollution degree	II / 2	II / 2	II / 2
Status indication	LED "Input"	LED "Input"	LED "Input"
Housing material	UL94V-0 plastic material	UL94V-0 plastic material	UL94V-0 plastic material
Dimensions	67x93x75 mm	137x93x75 mm	250x93x75 mm
Approximate weight	207 g	379 g	756 g
Mounting information	vertical on a rail, side by side	vertical on a rail, side by side	vertical on a rail, side by side
APPROVALS	CE	CE	CE
ACCESSORIES			
Mounting rail IEC60715 TH35 75	PR/3/AC, PR/3/AC/ZB, PR/3/AS, PR/3/AS/ZB	PR/3/AC, PR/3/AC/ZB, PR/3/AS, PR/3/AS/ZB	PR/3/AC, PR/3/AC/ZB, PR/3/AS, PR/3/AS/ZB
Mounting rail IEC60715 TH35 15	PR/3/PP, PR/3/PP/ZB, PR/3/PA, PR/3/PA/ZB	PR/3/PP, PR/3/PP/ZB, PR/3/PA, PR/3/PA/ZB	PR/3/PP, PR/3/PP/ZB, PR/3/PA, PR/3/PA/ZB
Marking tag	—	—	—
Spare part relay	8904404	8904404	8904404
End section	—	—	—
Plugin jumper	—	—	—

Interfacce

Interface
wiring modules

Diode and Lamp
holder modules

Blank lined area for notes.

QUICK PASSIVE INTERFACE SELECTION TABLE



INPUT CHANNELS	INPUT RATED VOLTAGE	CONTACT TYPE	NOMINAL CURRENT (RESISTIVE LOAD)	PLUGGABLE RELAY	NOT PLUGGABLE RELAY	POSITIVE CONTROL (PNP)
Interface module	D-sub male	9	37x66x93 mm	XISD09PM	ISD09PM	156
Interface module	D-sub male	15	47x66x93 mm	XISD15PM	ISD15PM	157
Interface module	D-sub male	25	70x66x93 mm	XISD25PM	ISD25PM	158
Interface module	D-sub male	37	107x66x93 mm	XISD37PM	ISD37PM	159
Interface module	D-sub female	9	37x66x93 mm	XISD09PF	ISD09PF	156
Interface module	D-sub female	15	47x66x93 mm	XISD15PF	ISD15PF	157
Interface module	D-sub female	25	70x66x93 mm	XISD25PF	ISD25PF	158
Interface module	D-sub female	37	107x66x93 mm	XISD37PF	ISD37PF	159
Interface module	D-sub male + female	9	37x66x93 mm	XISD09FM	ISD09FM	156
Interface module	D-sub male + female	15	47x66x93 mm	XISD15FM	ISD15FM	157
Interface module	D-sub male + female	25	70x66x93 mm	XISD25FM	ISD25FM	158
Interface module	D-sub male + female	37	107x66x93 mm	XISD37FM	ISD37FM	159
Interface module	D-sub male	25	57x80x93 mm	XCPD25M	CPD25M	160
Interface module	D-sub male	37	77x80x93 mm	XCPD37M	CPD37M	161
Interface module	D-sub male	50	92x80x93 mm	XCPD50M	CPD50M	162
Interface module	D-sub female	25	57x80x93 mm	XCPD25F	CPD25F	160
Interface module	D-sub female	37	77x80x93 mm	XCPD37F	CPD37F	161
Interface module	D-sub female	50	92x80x93 mm	XCPD50F	CPD50F	162
Interface module	IDC male	10	42x66x93 mm	XIF10PML	IF10PML	163
Interface module	IDC male	14	48x66x93 mm	XIF14PML	IF14PML	164
Interface module	IDC male	16	58x66x93 mm	XIF16PML	IF16PML	165
Interface module	IDC male	20	70x66x93 mm	XIF20PML	IF20PML	166
Interface module	IDC male	26	86x66x93 mm	XIF26PML	IF26PML	167
Interface module	IDC male	34	107x66x93 mm	XIF34PML	IF34PML	168
Interface module	IDC male	40	122x66x93 mm	XIF40PML	IF40PML	169
Interface module	IDC male	10	42x66x93 mm	XIF10PMS	IF10PMS	163
Interface module	IDC male	14	48x66x93 mm	XIF14PMS	IF14PMS	164
Interface module	IDC male	16	58x66x93 mm	XIF16PMS	IF16PMS	165
Interface module	IDC male	20	70x66x93 mm	XIF20PMS	IF20PMS	166
Interface module	IDC male	26	86x66x93 mm	XIF26PMS	IF26PMS	167
Interface module	IDC male	34	107x66x93 mm	XIF34PMS	IF34PMS	168
Interface module	IDC male	40	122x66x93 mm	XIF40PMS	IF40PMS	169
Interface module	IDC male	20	47x80x93 mm	XCPC20M	CPC20M	170
Interface module	IDC male	26	57x80x93 mm	XCPC26M	CPC26M	170
Interface module	IDC male	34	70x80x93 mm	XCPC34M	CPC34M	170
Interface module	IDC male	40	77x80x93 mm	XCPC40M	CPC40M	171
Interface module	IDC male	50	92x80x93 mm	XCPC50M	CPC50M	171
Interface module	IDC male	60	107x80x93 mm	XCPC60M	CPC60M	171
Interface module	IDC male	64	117x80x93 mm	XCPC64M	CPC64M	172
Component-holder modules	with common connection	8	25x55x93 mm	XCCM08CV	CCM08CV	173
Component-holder modules	with common connection	16	47x66x93 mm	XCCM16CV	CCM16CV	173
Component-holder modules	single feed-through	8	25x66x93 mm	XCCM08SV	CCM08SV	174
Component-holder modules	single feed-through	16	47x66x93 mm	XCCM16SV	CCM16SV	174
Component-holder modules	single feed-through	24	70x66x93 mm	XCCM24SV	CCM24SV	174
Diode modules	feed-through	8	25x60x76 mm	XCDM08CS	CDM08CS	174
Diode modules	feed-through	16	50x65x93 mm	XCDM16CS	CDM16CS	175
Diode modules	feed-through	24	71x65x93 mm	XCDM24CS	CDM24CS	175
Diode modules	common anode	8	45x65x93 mm	XCDM08AC	CDM08AC	176
Diode modules	common anode	16	92x65x93 mm	XCDM16AC	CDM16AC	176
Diode modules	common anode	24	137x65x93 mm	XCDM24AC	CDM24AC	176
Diode modules	common cathode	8	45x65x93 mm	XCDM08CC	CDM08CC	177
Diode modules	common cathode	16	92x65x93 mm	XCDM16CC	CDM16CC	177
Diode modules	common cathode	24	137x65x93 mm	XCDM24CC	CDM24CC	177
LED testing modules	common negative	8	45x65x93 mm	XCLT08AC	CLT08AC	178
LED testing modules	common negative	16	92x65x93 mm	XCLT16AC	CLT16AC	178
LED testing modules	common positive	8	45x65x93 mm	XCLT08CC	CLT08CC	179
LED testing modules	common positive	16	92x65x93 mm	XCLT16CC	CLT16CC	179
Lamp testing modules	common positive	8	45x65x93 mm	XCLP08CC	CLP08CC	180
Lamp testing modules	common positive	16	92x65x93 mm	XCLP16CC	CLP16CC	180

- Universal module

NOTE

The terminal number corresponds to the connector number



PRESENTATION PURPOSE ONLY

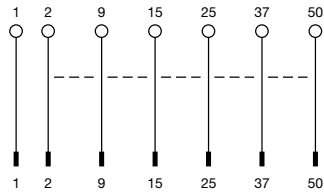

PRESENTATION PURPOSE ONLY

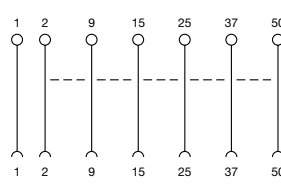

PRESENTATION PURPOSE ONLY

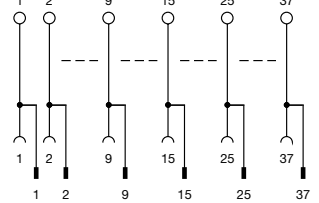

CODE	XISD09PM	XISD09PF	XISD09PF	XISD09FM
TYPE	ISD09PM	ISD09PF	XISD09PF	ISD09FM
GENERAL TECHNICAL DATA				
Number of poles	9	9	9	9
Version	D-sub male	D-sub female	D-sub female	D-sub male + female
Input rated voltage	0...25 Vac / 0...60 Vdc	0...25 Vac / 0...60 Vdc	0...25 Vac / 0...60 Vdc	0...25 Vac / 0...60 Vdc
Input rated current	2 A max	2 A max	2 A max	2 A max
Operating temperature	-20...+60°C	-20...+60°C	-20...+60°C	-20...+60°C
Standards approvals	—	—	—	—
Overvoltage category /pollution degree	II / 2	II / 2	II / 2	II / 2
Protection degree	IP 00	IP 00	IP 00	IP 00
Connection terminal	2.5 mm ² screw	2.5 mm ² screw	2.5 mm ² screw	2.5 mm ² screw
Status indication	—	—	—	—
Dimensions	37x66x93 mm	37x66x93 mm	37x66x93 mm	37x66x93 mm
Approximate weight	—	—	—	—
Housing material	UL94V-0 plastic material	UL94V-0 plastic material	UL94V-0 plastic material	UL94V-0 plastic material
Mounting informations	vertical on rails, side by side	vertical on rails, side by side	vertical on rails, side by side	vertical on rails, side by side
APPROVALS	CE	CE	CE	CE
ACCESSORIES				
Mounting rail IEC60715 TH35 75	PR003, PR903, PR005, PR905	PR003, PR903, PR005, PR909	PR003, PR903, PR005, PR909	PR003, PR903, PR005, PR913
Mounting rail IEC60715 TH35 15	PR007, PR907, PR006, PR906	PR007, PR907, PR006, PR910	PR007, PR907, PR006, PR910	PR007, PR907, PR006, PR914
Marking tag	—	—	—	—

- Universal module

NOTE

The terminal number corresponds to the connector number



PRESENTATION PURPOSE ONLY



PRESENTATION PURPOSE ONLY



PRESENTATION PURPOSE ONLY

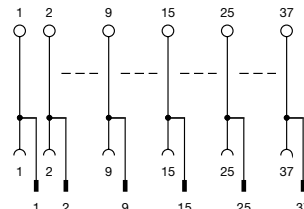
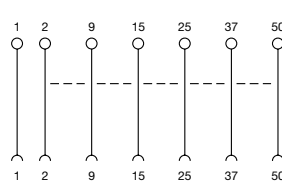
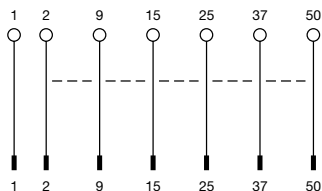

CODE	XISD15PM	XISD15PF	XISD15FM
TYPE	ISD15PM	ISD15PF	ISD15FM
GENERAL TECHNICAL DATA			
Number of poles	15	15	15
Version	D-sub male	D-sub female	D-sub male + female
Input rated voltage	0...25 Vac / 0...60 Vdc	0...25 Vac / 0...60 Vdc	0...25 Vac / 0...60 Vdc
Input rated current	2 A max	2 A max	2 A max
Operating temperature	-20...+60°C	-20...+60°C	-20...+60°C
Standards approvals	—	—	—
Overvoltage category /pollution degree	II / 2	II / 2	II / 2
Protection degree	IP 00	IP 00	IP 00
Connection terminal	2.5 mm ² screw	2.5 mm ² screw	2.5 mm ² screw
Status indication	—	—	—
Dimensions	47x66x93 mm	47x66x93 mm	47x66x93 mm
Approximate weight	—	—	—
Housing material	UL94V-0 plastic material	UL94V-0 plastic material	UL94V-0 plastic material
Mounting informations	vertical on rails, side by side	vertical on rails, side by side	vertical on rails, side by side
APPROVALS	CE	CE	CE
ACCESSORIES			
Mounting rail IEC60715 TH35 75	PR003, PR903, PR005, PR906	PR003, PR903, PR005, PR910	PR003, PR903, PR005, PR914
Mounting rail IEC60715 TH35 15	PR007, PR907, PR006, PR907	PR007, PR907, PR006, PR911	PR007, PR907, PR006, PR915
Marking tag	—	—	—

- Universal module

NOTE

The terminal number corresponds to the connector number

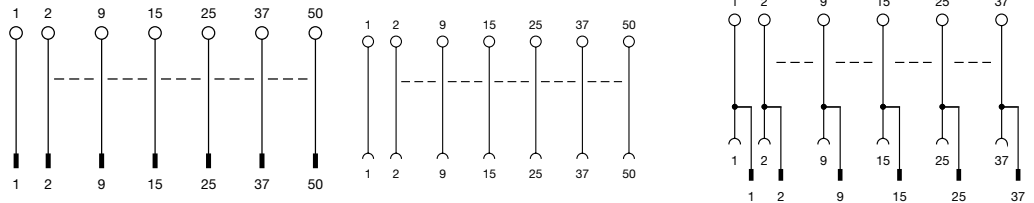

CODE	XISD25PM	XISD25PF	XISD25FM
TYPE	ISD25PM	ISD25PF	ISD25FM
GENERAL TECHNICAL DATA			
Number of poles	25	25	25
Version	D-sub male	D-sub female	D-sub male + female
Input rated voltage	0...25 Vac / 0...60 Vdc	0...25 Vac / 0...60 Vdc	0...25 Vac / 0...60 Vdc
Input rated current	2 A max	2 A max	2 A max
Operating temperature	-20...+60°C	-20...+60°C	-20...+60°C
Standards approvals	—	—	—
Overvoltage category / pollution degree	II / 2	II / 2	II / 2
Protection degree	IP 00	IP 00	IP 00
Connection terminal	2.5 mm ² screw	2.5 mm ² screw	2.5 mm ² screw
Status indication	—	—	—
Dimensions	70x66x93 mm	70x66x93 mm	70x66x93 mm
Approximate weight	—	—	—
Housing material	UL94V-0 plastic material	UL94V-0 plastic material	UL94V-0 plastic material
Mounting informations	vertical on rails, side by side	vertical on rails, side by side	vertical on rails, side by side
APPROVALS	CE	CE	CE
ACCESSORIES			
Mounting rail IEC60715 TH35 75	PR003, PR903, PR005, PR907	PR003, PR903, PR005, PR911	PR003, PR903, PR005, PR915
Mounting rail IEC60715 TH35 15	PR007, PR907, PR006, PR908	PR007, PR907, PR006, PR912	PR007, PR907, PR006, PR916
Marking tag	—	—	—

- Universal module

NOTE

The terminal number corresponds to the connector number



ILLUSTRATIVE PURPOSE ONLY



ILLUSTRATIVE PURPOSE ONLY



ILLUSTRATIVE PURPOSE ONLY

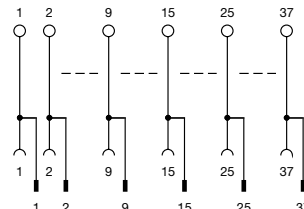
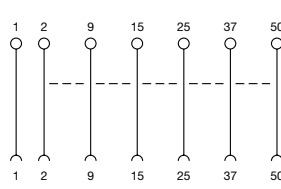
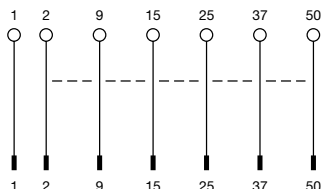

CODE	XISD37PM	XISD37PF	XISD37FM
TYPE	ISD37PM	ISD37PF	ISD37FM
GENERAL TECHNICAL DATA			
Number of poles	37	37	37
Version	D-sub male	D-sub female	D-sub male + female
Input rated voltage	0...25 Vac / 0...60 Vdc	0...25 Vac / 0...60 Vdc	0...25 Vac / 0...60 Vdc
Input rated current	2 A max	2 A max	2 A max
Operating temperature	-20...+60°C	-20...+60°C	-20...+60°C
Standards approvals	—	—	—
Overvoltage category /pollution degree	II / 2	II / 2	II / 2
Protection degree	IP 00	IP 00	IP 00
Connection terminal	2.5 mm ² screw	2.5 mm ² screw	2.5 mm ² screw
Status indication	—	—	—
Dimensions	107x66x93 mm	107x66x93 mm	107x66x93 mm
Approximate weight	—	—	—
Housing material	UL94V-0 plastic material	UL94V-0 plastic material	UL94V-0 plastic material
Mounting informations	vertical on rails, side by side	vertical on rails, side by side	vertical on rails, side by side
APPROVALS	CE	CE	CE
ACCESSORIES			
Mounting rail IEC60715 TH35 75	PR003, PR903, PR005, PR908	PR003, PR903, PR005, PR912	PR003, PR903, PR005, PR916
Mounting rail IEC60715 TH35 15	PR007, PR907, PR006, PR909	PR007, PR907, PR006, PR913	PR007, PR907, PR006, PR917
Marking tag	—	—	—

- Universal module
- Compact dimensions

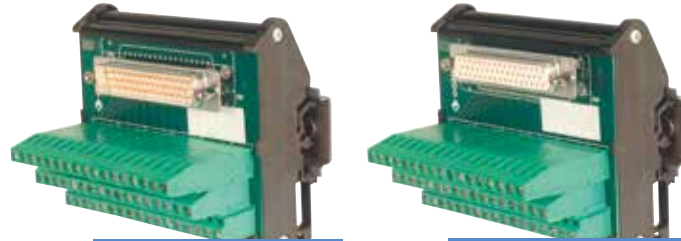

PRESENTATION PURPOSE ONLY

PRESENTATION PURPOSE ONLY

NOTE

The terminal number corresponds to the connector number

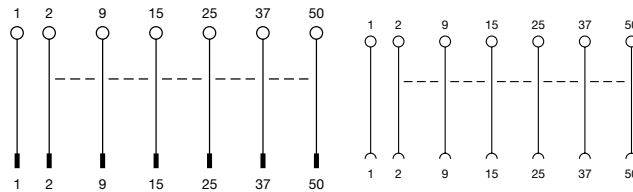

CODE	XCPD25M	XCPD25F
TYPE	CPD25M	CPD25F
GENERAL TECHNICAL DATA		
Number of poles	25	25
Version	D-sub male	D-sub female
Input rated voltage	0...25 Vac / 0...60 Vdc	0...25 Vac / 0...60 Vdc
Input rated current	2 A max	2 A max
Operating temperature	-20...+60°C	-20...+60°C
Standards approvals	—	—
Overvoltage category / pollution degree	II / 2	II / 2
Protection degree	IP 00	IP 00
Connection terminal	2.5 mm ² screw	2.5 mm ² screw
Status indication	—	—
Dimensions	57x80x93 mm	57x80x93 mm
Approximate weight	—	—
Housing material	UL94V-0 plastic material	UL94V-0 plastic material
Mounting informations	vertical on rails, side by side	vertical on rails, side by side
APPROVALS	CE	CE
ACCESSORIES		
Mounting rail IEC60715 TH35 75	PR003, PR903, PR005, PR917	PR003, PR903, PR005, PR920
Mounting rail IEC60715 TH35 15	PR007, PR907, PR006, PR918	PR007, PR907, PR006, PR921
Marking tag	—	—

- Universal module
- Compact dimensions

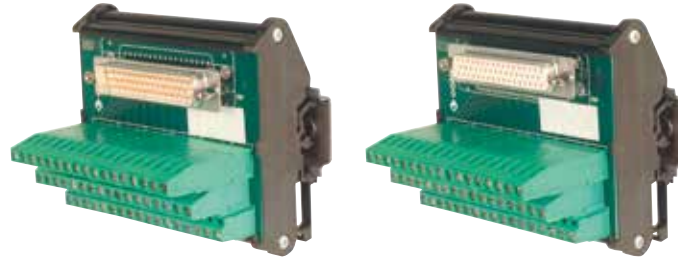

NOTE

The terminal number corresponds to the connector number

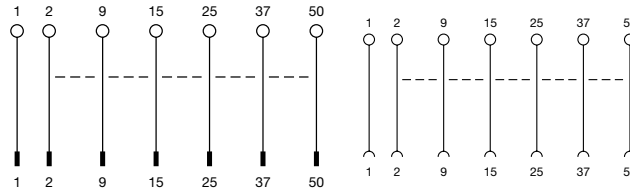

CODE	XCPD37M	XCPD37F
TYPE	CPD37M	CPD37F
GENERAL TECHNICAL DATA		
Number of poles	37	37
Version	D-sub male	D-sub female
Input rated voltage	0...25 Vac / 0...60 Vdc	0...25 Vac / 0...60 Vdc
Input rated current	2 A max	2 A max
Operating temperature	-20...+60°C	-20...+60°C
Standards approvals	—	—
Overvoltage category / pollution degree	II / 2	II / 2
Protection degree	IP 00	IP 00
Connection terminal	2.5 mm ² screw	2.5 mm ² screw
Status indication	—	—
Dimensions	77x80x93 mm	77x80x93 mm
Approximate weight	—	—
Housing material	UL94V-0 plastic material	UL94V-0 plastic material
Mounting informations	vertical on rails, side by side	vertical on rails, side by side
APPROVALS	CE	CE
ACCESSORIES		
Mounting rail IEC60715 TH35 75	PR003, PR903, PR005, PR918	PR003, PR903, PR005, PR921
Mounting rail IEC60715 TH35 15	PR007, PR907, PR006, PR919	PR007, PR907, PR006, PR922
Marking tag	—	—

- Universal module
- Compact dimensions



PRESENTATION PURPOSE ONLY

PRESENTATION PURPOSE ONLY

NOTE

The terminal number corresponds to the connector number

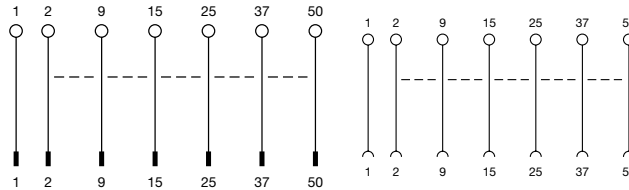

CODE	XCPD50M	XCPD50F
TYPE	CPD50M	CPD50F
GENERAL TECHNICAL DATA		
Number of poles	50	50
Version	D-sub male	D-sub female
Input rated voltage	0...25 Vac / 0...60 Vdc	0...25 Vac / 0...60 Vdc
Input rated current	2 A max	2 A max
Operating temperature	-20...+60°C	-20...+60°C
Standards approvals	—	—
Overvoltage category / pollution degree	II / 2	II / 2
Protection degree	IP 00	IP 00
Connection terminal	2.5 mm ² screw	2.5 mm ² screw
Status indication	—	—
Dimensions	92x80x93 mm	92x80x93 mm
Approximate weight	—	—
Housing material	UL94V-0 plastic material	UL94V-0 plastic material
Mounting informations	vertical on rails, side by side	vertical on rails, side by side
APPROVALS	CE	CE
ACCESSORIES		
Mounting rail IEC60715 TH35 75	PR003, PR903, PR005, PR919	PR003, PR903, PR005, PR922
Mounting rail IEC60715 TH35 15	PR007, PR907, PR006, PR920	PR007, PR907, PR006, PR923
Marking tag	—	—

- Universal module



PRESENTATION PURPOSE ONLY

NOTE

The terminal number corresponds to the connector number

(1) Status LEDs are configured for a nominal voltage of 24 Vdc and negative common

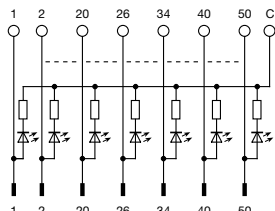

CODE	IF10PML	XIF10PML	IF10PMS	XIF10PMS
TYPE				
GENERAL TECHNICAL DATA				
Number of poles	10		10	
Version	IDC male		IDC male	
Input rated voltage	0...50 Vac/dc		0...50 Vac/dc	
Input rated current	750 mA max		750 mA max	
Operating temperature	-20...+60°C		-20...+60°C	
Standards approvals	—		—	
Overvoltage category /pollution degree	II / 2		II / 2	
Protection degree	IP 00		IP 00	
Connection terminal	2.5 mm ² screw		2.5 mm ² screw	
Status indication	LED (1)		—	
Dimensions	42x66x93 mm		42x66x93 mm	
Approximate weight	—		—	
Housing material	UL94V-0 plastic material		UL94V-0 plastic material	
Mounting informations	vertical on rails, side by side		vertical on rails, side by side	
APPROVALS	CE		CE	
ACCESSORIES				
Mounting rail IEC60715 TH35 75	PR003, PR903, PR005, PR923		PR003, PR903, PR005, PR923	
Mounting rail IEC60715 TH35 15	PR007, PR907, PR006, PR924		PR007, PR907, PR006, PR924	
Marking tag	—		—	

- Universal module



PRESENTATION PURPOSE ONLY

NOTE

The terminal number corresponds to the connector number

(1) Status LEDs are configured for a nominal voltage of 24 Vdc and negative common

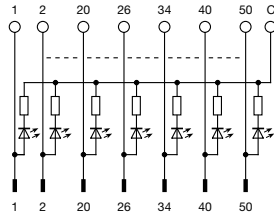

CODE	IF14PML	XIF14PML	IF14PMS	XIF14PMS
TYPE				
GENERAL TECHNICAL DATA				
Number of poles	14		14	
Version	IDC male		IDC male	
Input rated voltage	0...50 Vac/dc		0...50 Vac/dc	
Input rated current	750 mA max		750 mA max	
Operating temperature	-20...+60°C		-20...+60°C	
Standards approvals	—		—	
Overvoltage category /pollution degree	II / 2		II / 2	
Protection degree	IP 00		IP 00	
Connection terminal	2.5 mm ² screw		2.5 mm ² screw	
Status indication	LED (1)		—	
Dimensions	48x66x93 mm		48x66x93 mm	
Approximate weight	—		—	
Housing material	UL94V-0 plastic material		UL94V-0 plastic material	
Mounting informations	vertical on rails, side by side		vertical on rails, side by side	
APPROVALS	CE		CE	
ACCESSORIES				
Mounting rail IEC60715 TH35 75	PR003, PR903, PR005, PR924		PR003, PR903, PR005, PR924	
Mounting rail IEC60715 TH35 15	PR007, PR907, PR006, PR925		PR007, PR907, PR006, PR925	
Marking tag	—		—	

- Universal module



PRESENTATION PURPOSE ONLY

NOTE

The terminal number corresponds to the connector number

(1) Status LEDs are configured for a nominal voltage of 24 Vdc and negative common

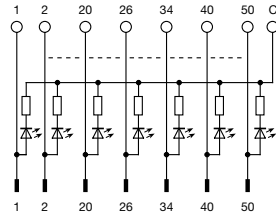

CODE	IF16PML	XIF16PML	IF16PMS	XIF16PMS
TYPE				
GENERAL TECHNICAL DATA				
Number of poles	16		16	
Version	IDC male		IDC male	
Input rated voltage	0...50 Vac/dc		0...50 Vac/dc	
Input rated current	750 mA max		750 mA max	
Operating temperature	-20...+60°C		-20...+60°C	
Standards approvals	—		—	
Overvoltage category /pollution degree	II / 2		II / 2	
Protection degree	IP 00		IP 00	
Connection terminal	2.5 mm ² screw		2.5 mm ² screw	
Status indication	LED (1)		—	
Dimensions	58x66x93 mm		58x66x93 mm	
Approximate weight	—		—	
Housing material	UL94V-0 plastic material		UL94V-0 plastic material	
Mounting informations	vertical on rails, side by side		vertical on rails, side by side	
APPROVALS	CE		CE	
ACCESSORIES				
Mounting rail IEC60715 TH35 75	PR003, PR903, PR005, PR925		PR003, PR903, PR005, PR925	
Mounting rail IEC60715 TH35 15	PR007, PR907, PR006, PR926		PR007, PR907, PR006, PR926	
Marking tag	—		—	

- Universal module



NOTE

The terminal number corresponds to the connector number

(1) Status LEDs are configured for a nominal voltage of 24 Vdc and negative common

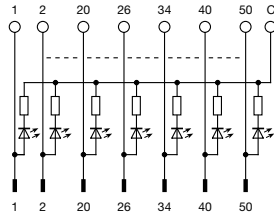

CODE	IF20PML	XIF20PML	IF20PMS	XIF20PMS
TYPE				
GENERAL TECHNICAL DATA				
Number of poles	20		20	
Version	IDC male		IDC male	
Input rated voltage	0...50 Vac/dc		0...50 Vac/dc	
Input rated current	750 mA max		750 mA max	
Operating temperature	-20...+60°C		-20...+60°C	
Standards approvals	—		—	
Overvoltage category /pollution degree	II / 2		II / 2	
Protection degree	IP 00		IP 00	
Connection terminal	2.5 mm ² screw		2.5 mm ² screw	
Status indication	LED (1)		—	
Dimensions	70x66x93 mm		70x66x93 mm	
Approximate weight	—		—	
Housing material	UL94V-0 plastic material		UL94V-0 plastic material	
Mounting informations	vertical on rails, side by side		vertical on rails, side by side	
APPROVALS	CE		CE	
ACCESSORIES				
Mounting rail IEC60715 TH35 75	PR003, PR903, PR005, PR926		PR003, PR903, PR005, PR926	
Mounting rail IEC60715 TH35 15	PR007, PR907, PR006, PR927		PR007, PR907, PR006, PR927	
Marking tag	—		—	

- Universal module



PRESENTATION PURPOSE ONLY

NOTE

The terminal number corresponds to the connector number

(1) Status LEDs are configured for a nominal voltage of 24 Vdc and negative common

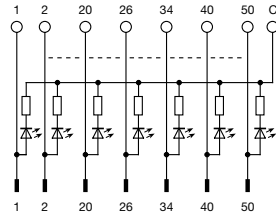

CODE	IF26PML	XIF26PML	IF26PMS	XIF26PMS
TYPE				
GENERAL TECHNICAL DATA				
Number of poles	26		26	
Version	IDC male		IDC male	
Input rated voltage	0...50 Vac/dc		0...50 Vac/dc	
Input rated current	750 mA max		750 mA max	
Operating temperature	-20...+60°C		-20...+60°C	
Standards approvals	—		—	
Overvoltage category /pollution degree	II / 2		II / 2	
Protection degree	IP 00		IP 00	
Connection terminal	2.5 mm ² screw		2.5 mm ² screw	
Status indication	LED (1)		—	
Dimensions	86x66x93 mm		86x66x93 mm	
Approximate weight	—		—	
Housing material	UL94V-0 plastic material		UL94V-0 plastic material	
Mounting informations	vertical on rails, side by side		vertical on rails, side by side	
APPROVALS	CE		CE	
ACCESSORIES				
Mounting rail IEC60715 TH35 75	PR003, PR903, PR005, PR927		PR003, PR903, PR005, PR927	
Mounting rail IEC60715 TH35 15	PR007, PR907, PR006, PR928		PR007, PR907, PR006, PR928	
Marking tag	—		—	

- Universal module



PRESENTATION PURPOSE ONLY

NOTE

The terminal number corresponds to the connector number

(1) Status LEDs are configured for a nominal voltage of 24 Vdc and negative common

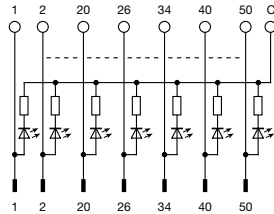

CODE	IF34PML	XIF34PML	IF34PMS	XIF34PMS
TYPE				
GENERAL TECHNICAL DATA				
Number of poles	34		34	
Version	IDC male		IDC male	
Input rated voltage	0...50 Vac/dc		0...50 Vac/dc	
Input rated current	750 mA max		750 mA max	
Operating temperature	-20...+60°C		-20...+60°C	
Standards approvals	—		—	
Overvoltage category /pollution degree	II / 2		II / 2	
Protection degree	IP 00		IP 00	
Connection terminal	2.5 mm ² screw		2.5 mm ² screw	
Status indication	LED (1)		—	
Dimensions	107x66x93 mm		107x66x93 mm	
Approximate weight	—		—	
Housing material	UL94V-0 plastic material		UL94V-0 plastic material	
Mounting informations	vertical on rails, side by side		vertical on rails, side by side	
APPROVALS	CE		CE	
ACCESSORIES				
Mounting rail IEC60715 TH35 75	PR003, PR903, PR005, PR928		PR003, PR903, PR005, PR928	
Mounting rail IEC60715 TH35 15	PR007, PR907, PR006, PR929		PR007, PR907, PR006, PR929	
Marking tag	—		—	

- Universal module



PRESENTATION PURPOSE ONLY

NOTE

The terminal number corresponds to the connector number

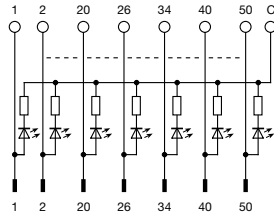

CODE	IF40PML	XIF40PML	IF40PMS	XIF40PMS
TYPE				
GENERAL TECHNICAL DATA				
Number of poles	40		40	
Version	IDC male		IDC male	
Input rated voltage	0...50 Vac/dc		0...50 Vac/dc	
Input rated current	750 mA max		750 mA max	
Operating temperature	-20...+60°C		-20...+60°C	
Standards approvals	—		—	
Overvoltage category /pollution degree	II / 2		II / 2	
Protection degree	IP 00		IP 00	
Connection terminal	2.5 mm ² screw		2.5 mm ² screw	
Status indication	—		—	
Dimensions	122x66x93 mm		122x66x93 mm	
Approximate weight	—		—	
Housing material	UL94V-0 plastic material		UL94V-0 plastic material	
Mounting informations	vertical on rails, side by side		vertical on rails, side by side	
APPROVALS	CE		CE	
ACCESSORIES				
Mounting rail IEC60715 TH35 75	PR003, PR903, PR005, PR929		PR003, PR903, PR005, PR929	
Mounting rail IEC60715 TH35 15	PR007, PR907, PR006, PR930		PR007, PR907, PR006, PR930	
Marking tag	—		—	

- Universal module
- Compact dimensions

NOTE

The terminal number corresponds to the connector number



PRESENTATION PURPOSE ONLY

PRESENTATION PURPOSE ONLY

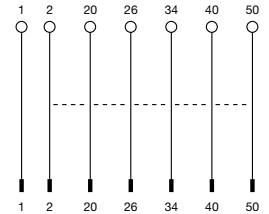
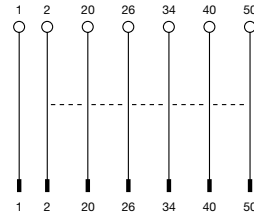
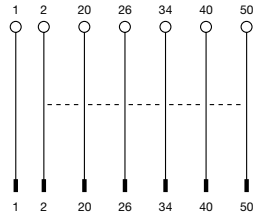

CODE	XPCPC20M	XPCPC26M	XPCPC34M
TYPE	CPC20M	CPC26M	CPC34M
GENERAL TECHNICAL DATA			
Number of poles	20	26	34
Version	IDC male	IDC male	IDC male
Input rated voltage	0...50 Vac/dc	0...50 Vac/dc	0...50 Vac/dc
Input rated current	750 mA max	750 mA max	750 mA max
Operating temperature	-20...+60°C	-20...+60°C	-20...+60°C
Standards approvals	—	—	—
Overvoltage category /pollution degree	II / 2	II / 2	II / 2
Protection degree	IP 00	IP 00	IP 00
Connection terminal	2.5 mm ² screw	2.5 mm ² screw	2.5 mm ² screw
Status indication	—	—	—
Dimensions	47x80x93 mm	57x80x93 mm	70x80x93 mm
Approximate weight	—	—	—
Housing material	UL94V-0 plastic material	UL94V-0 plastic material	UL94V-0 plastic material
Mounting informations	vertical on rails, side by side	vertical on rails, side by side	vertical on rails, side by side
APPROVALS	CE	CE	CE
ACCESSORIES			
Mounting rail IEC60715 TH35 75	PR003, PR903, PR005, PR930	PR003, PR903, PR005, PR931	PR003, PR903, PR005, PR932
Mounting rail IEC60715 TH35 15	PR007, PR907, PR006, PR931	PR007, PR907, PR006, PR932	PR007, PR907, PR006, PR933
Marking tag	—	—	—

- Universal module
- Compact dimensions

NOTE

The terminal number corresponds to the connector number



PRESENTATION PURPOSE ONLY

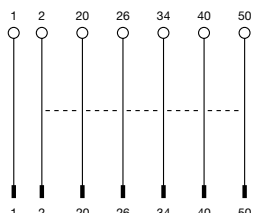

PRESENTATION PURPOSE ONLY

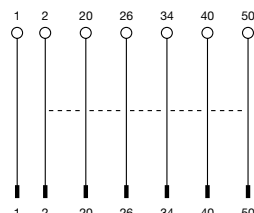

PRESENTATION PURPOSE ONLY

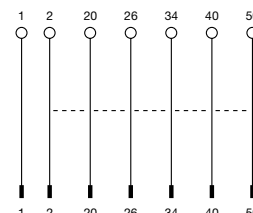

CODE	CPC40M	XPC40M	CPC50M	XPC50M	CPC60M	XPC60M
TYPE	CPC40M		CPC50M		CPC60M	
GENERAL TECHNICAL DATA						
Number of poles	40		50		60	
Version	IDC male		IDC male		IDC male	
Input rated voltage	0...50 Vac/dc		0...50 Vac/dc		0...50 Vac/dc	
Input rated current	750 mA max		750 mA max		750 mA max	
Operating temperature	-20...+60°C		-20...+60°C		-20...+60°C	
Standards approvals	—		—		—	
Overvoltage category /pollution degree	II / 2		II / 2		II / 2	
Protection degree	IP 00		IP 00		IP 00	
Connection terminal	2.5 mm ² screw		2.5 mm ² screw		2.5 mm ² screw	
Status indication	—		—		—	
Dimensions	77x80x93 mm		92x80x93 mm		107x80x93 mm	
Approximate weight	—		—		—	
Housing material	UL94V-0 plastic material		UL94V-0 plastic material		UL94V-0 plastic material	
Mounting informations	vertical on rails, side by side		vertical on rails, side by side		vertical on rails, side by side	
APPROVALS	CE		CE		CE	
ACCESSORIES						
Mounting rail IEC60715 TH35 75	PR003, PR903, PR005, PR933		PR003, PR903, PR005, PR934		PR003, PR903, PR005, PR935	
Mounting rail IEC60715 TH35 15	PR007, PR907, PR006, PR934		PR007, PR907, PR006, PR935		PR007, PR907, PR006, PR936	
Marking tag	—		—		—	

- Universal module
- Compact dimensions



PRESENTATION PURPOSE ONLY

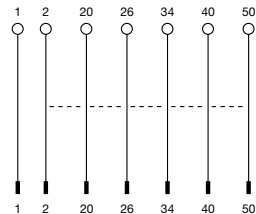

NOTE
The terminal number corresponds to the connector number

CODE	CPC64M	XCPC64M
TYPE	CPC64M	XCPC64M
GENERAL TECHNICAL DATA		
Number of poles	64	
Version	IDC male	
Input rated voltage	0...50 Vac/dc	
Input rated current	750 mA max	
Operating temperature	-20...+60°C	
Standards approvals	—	
Overvoltage category /pollution degree	II / 2	
Protection degree	IP 00	
Connection terminal	2.5 mm ² screw	
Status indication	—	
Dimensions	117x80x93 mm	
Approximate weight	—	
Housing material	UL94V-0 plastic material	
Mounting informations	vertical on rails, side by side	
APPROVALS	CE	
ACCESSORIES		
Mounting rail IEC60715 TH35 75	PR003, PR903, PR005, PR936	
Mounting rail IEC60715 TH35 15	PR007, PR907, PR006, PR937	
Marking tag	—	

- Suitable for diodes and resistors
- Small size

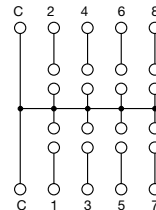
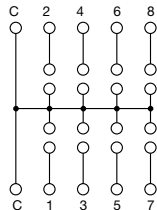
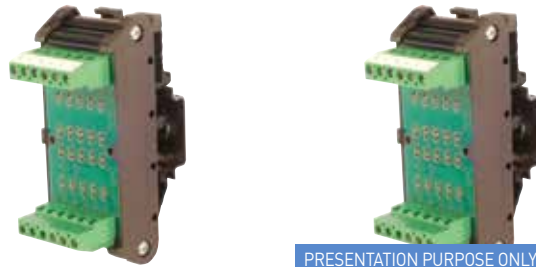

CODE	XCCM08CV	XCCM16CV
TYPE	CCM08CV	CCM16CV
GENERAL TECHNICAL DATA		
Number of poles	8	16
Version	with common connection	with common connection
Input rated voltage	0...220 V ±10%	0...220 V ±10%
Input rated current	5 A channel / 15 A on common	5 A channel / 15 A on common
Operating temperature	-20...+60°C	-20...+60°C
Standards approvals	—	—
Overvoltage category /pollution degree	II / 2	II / 2
Protection degree	IP 00	IP 00
Connection terminal	2.5 mm ² screw	2.5 mm ² screw
Status indication	—	—
Dimensions	25x55x93 mm	47x66x93 mm
Approximate weight	—	—
Housing material	UL94V-0 plastic material	UL94V-0 plastic material
Mounting informations	vertical on rails, side by side	vertical on rails, side by side
APPROVALS	CE	CE
ACCESSORIES		
Mounting rail IEC60715 TH35 75	PR003, PR903, PR005, PR937	PR003, PR903, PR005, PR938
Mounting rail IEC60715 TH35 15	PR007, PR907, PR006, PR938	PR007, PR907, PR006, PR939
Marking tag	—	—

- Suitable for diodes and resistors
- Small size

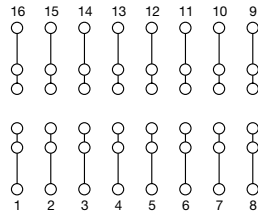

PRESENTATION PURPOSE ONLY

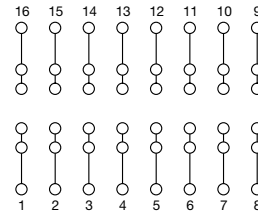

PRESENTATION PURPOSE ONLY

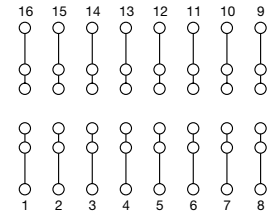

CODE	XCCM08SV	XCCM16SV	XCCM24SV
TYPE	CCM08SV	CCM16SV	CCM24SV
GENERAL TECHNICAL DATA			
Number of poles	8	16	24
Version	single feed-through	single feed-through	single feed-through
Input rated voltage	0...100 V ±10%	0...100 V ±10%	0...100 V ±10%
Input rated current	4 A max. (on common)	4 A max. (on common)	4 A max. (on common)
Operating temperature	-20...+60°C	-20...+60°C	-20...+60°C
Standards approvals	—	—	—
Overvoltage category /pollution degree	II / 2	II / 2	II / 2
Protection degree	IP 00	IP 00	IP 00
Connection terminal	2.5 mm ² screw	2.5 mm ² screw	2.5 mm ² screw
Status indication	—	—	—
Dimensions	25x66x93 mm	47x66x93 mm	70x66x93 mm
Approximate weight	—	—	—
Housing material	UL94V-0 plastic material	UL94V-0 plastic material	UL94V-0 plastic material
Mounting informations	vertical on rails, side by side	vertical on rails, side by side	vertical on rails, side by side
APPROVALS	CE	CE	CE
ACCESSORIES			
Mounting rail IEC60715 TH35 75	PR003, PR903, PR005, PR939	PR003, PR903, PR005, PR940	PR003, PR903, PR005, PR941
Mounting rail IEC60715 TH35 15	PR007, PR907, PR006, PR940	PR007, PR907, PR006, PR941	PR007, PR907, PR006, PR942
Marking tag	—	—	—

NOTE
The module is equipped with 1N4007 diodes

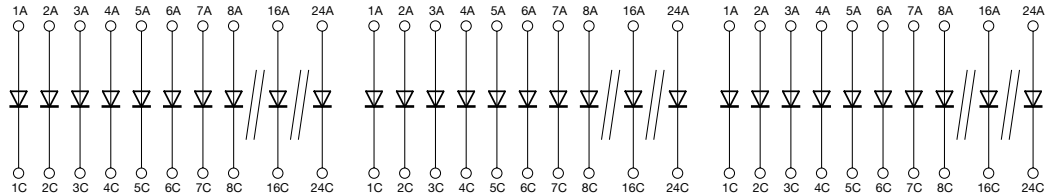

CODE	XCDM08CS	XCDM16CS	XCDM24CS
TYPE	CDM08CS	CDM16CS	CDM24CS
GENERAL TECHNICAL DATA			
Number of poles	8	16	24
Version	feed-through	feed-through	feed-through
Input rated voltage	0...100 V ±10%	0...100 V ±10%	0...100 V ±10%
Input rated current	Applicable current 1 A max	Applicable current 1 A max	Applicable current 1 A max
Operating temperature	-20...+60°C	-20...+60°C	-20...+60°C
Standards approvals	—	—	—
Overvoltage category /pollution degree	II / 2	II / 2	II / 2
Protection degree	IP 00	IP 00	IP 00
Connection terminal	2.5 mm ² screw	2.5 mm ² screw	2.5 mm ² screw
Status indication	—	—	—
Dimensions	25x60x76 mm	50x65x93 mm	71x65x93 mm
Approximate weight	—	—	—
Housing material	UL94V-0 plastic material	UL94V-0 plastic material	UL94V-0 plastic material
Mounting informations	vertical on rails, side by side	vertical on rails, side by side	vertical on rails, side by side
APPROVALS	CE	CE	CE
ACCESSORIES			
Mounting rail IEC60715 TH35 75	PR003, PR903, PR005, PR942	PR003, PR903, PR005, PR943	PR003, PR903, PR005, PR944
Mounting rail IEC60715 TH35 15	PR007, PR907, PR006, PR943	PR007, PR907, PR006, PR944	PR007, PR907, PR006, PR945
Marking tag	—	—	—

NOTE

The module is equipped with 1N4007 diodes



PRESENTATION PURPOSE ONLY

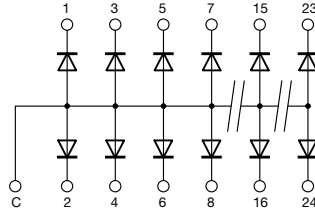

PRESENTATION PURPOSE ONLY

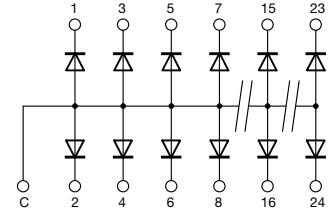
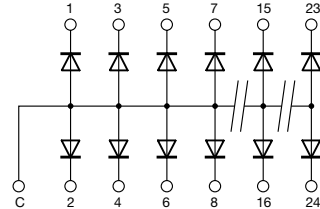

CODE	CDM08AC	XCDM08AC	CDM16AC	XCDM16AC	CDM24AC	XCDM24AC
TYPE	CDM08AC		CDM16AC		CDM24AC	
GENERAL TECHNICAL DATA						
Number of poles	8		16		24	
Version	common anode		common anode		common anode	
Input rated voltage	0...220 V ±10%		0...220 V ±10%		0...220 V ±10%	
Input rated current	1 A channel / 15 A on common		1 A channel / 15 A on common		1 A channel / 15 A on common	
Operating temperature	-20...+60°C		-20...+60°C		-20...+60°C	
Standards approvals	—		—		—	
Overvoltage category /pollution degree	II / 2		II / 2		II / 2	
Protection degree	IP 00		IP 00		IP 00	
Connection terminal	2.5 mm ² screw		2.5 mm ² screw		2.5 mm ² screw	
Status indication	—		—		—	
Dimensions	45x65x93 mm		92x65x93 mm		137x65x93 mm	
Approximate weight	—		—		—	
Housing material	UL94V-0 plastic material		UL94V-0 plastic material		UL94V-0 plastic material	
Mounting informations	vertical on rails, side by side		vertical on rails, side by side		vertical on rails, side by side	
APPROVALS	CE		CE		CE	
ACCESSORIES						
Mounting rail IEC60715 TH35 75	PR003, PR903, PR005, PR945		PR003, PR903, PR005, PR946		PR003, PR903, PR005, PR947	
Mounting rail IEC60715 TH35 15	PR007, PR907, PR006, PR946		PR007, PR907, PR006, PR947		PR007, PR907, PR006, PR948	
Marking tag	—		—		—	

NOTE
The module is equipped with 1N4007 diodes



PRESENTATION PURPOSE ONLY

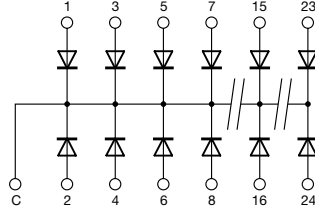

PRESENTATION PURPOSE ONLY

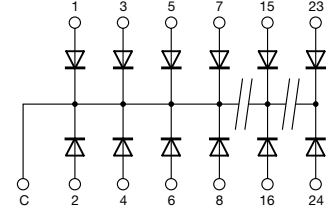
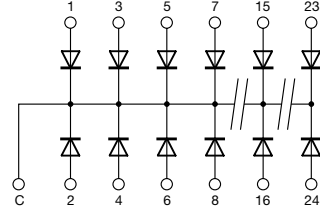

CODE	XCDM08CC	XCDM16CC	XCDM24CC
TYPE	CDM08CC	CDM16CC	CDM24CC
GENERAL TECHNICAL DATA			
Number of poles	8	16	24
Version	common cathode	common cathode	common cathode
Input rated voltage	0...220 V ±10%	0...220 V ±10%	0...220 V ±10%
Input rated current	1 A channel / 15 A on common	1 A channel / 15 A on common	1 A channel / 15 A on common
Operating temperature	-20...+60°C	-20...+60°C	-20...+60°C
Standards approvals	—	—	—
Overvoltage category /pollution degree	II / 2	II / 2	II / 2
Protection degree	IP 00	IP 00	IP 00
Connection terminal	2.5 mm ² screw	2.5 mm ² screw	2.5 mm ² screw
Status indication	—	—	—
Dimensions	45x65x93 mm	92x65x93 mm	137x65x93 mm
Approximate weight	—	—	—
Housing material	UL94V-0 plastic material	UL94V-0 plastic material	UL94V-0 plastic material
Mounting informations	vertical on rails, side by side	vertical on rails, side by side	vertical on rails, side by side
APPROVALS	CE	CE	CE
ACCESSORIES			
Mounting rail IEC60715 TH35 75	PR003, PR903, PR005, PR948	PR003, PR903, PR005, PR949	PR003, PR903, PR005, PR950
Mounting rail IEC60715 TH35 15	PR007, PR907, PR006, PR949	PR007, PR907, PR006, PR950	PR007, PR907, PR006, PR951
Marking tag	—	—	—

- Integrated limit resistors
- Suitable only for LEDs without limitation resistors or internal adapter circuit
- Compact dimensions



PRESENTATION PURPOSE ONLY

NOTE

[1] LEDs light up, with a negative command on the common terminal

The module is suitable only for simple LEDs, not for LED lamps, which are equipped with its own internal electronic circuit to adjust the nominal voltage.

The module is equipped with 1N4007 diodes and 4.7 kΩ 1/4 W resistors

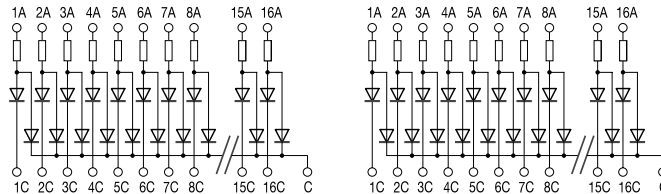

CODE	XCLT08AC	XCLT16AC
TYPE	CLT08AC	CLT16AC
GENERAL TECHNICAL DATA		
Number of poles	8	16
Version	common negative [1]	common negative [1]
Input rated voltage	24 Vdc max 30 Vdc	24 Vdc max 30 Vdc
Input rated current	5 mA [24 Vdc]	5 mA [24 Vdc]
Operating temperature	-20...+45°C	-20...+45°C
Standards approvals	—	—
Overvoltage category /pollution degree	II / 2	II / 2
Protection degree	IP 00	IP 00
Connection terminal	2.5 mm ² screw	2.5 mm ² screw
Status indication	—	—
Dimensions	45x65x93 mm	92x65x93 mm
Approximate weight	—	—
Housing material	UL94V-0 plastic material	UL94V-0 plastic material
Mounting informations	vertical on rails, side by side	vertical on rails, side by side
APPROVALS	CE	CE
ACCESSORIES		
Mounting rail IEC60715 TH35 75	PR003, PR903, PR005, PR951	PR003, PR903, PR005, PR952
Mounting rail IEC60715 TH35 15	PR007, PR907, PR006, PR952	PR007, PR907, PR006, PR953
Marking tag	—	—

- Integrated limit resistors
- Suitable only for LEDs without limitation resistors or internal adapter circuit
- Compact dimensions

NOTE

[1] LEDs light up, with a positive command on the common terminal

The module is suitable only for simple LEDs, not for LED lamps, which are equipped with its own internal electronic circuit to adjust the nominal voltage.

The module is equipped with 1N4007 diodes and 4.7 kΩ 1/4 W resistors



PRESENTATION PURPOSE ONLY

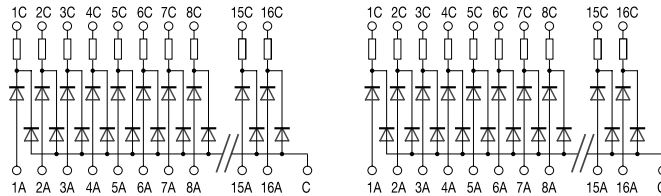

CODE	XCLT08CC	XCLT16CC
TYPE	CLT08CC	CLT16CC
GENERAL TECHNICAL DATA		
Number of poles	8	16
Version	common positive [1]	common positive [1]
Input rated voltage	24 Vdc max 30 Vdc	24 Vdc max 30 Vdc
Input rated current	5 mA [24 Vdc]	5 mA [24 Vdc]
Operating temperature	-20...+45°C	-20...+45°C
Standards approvals	—	—
Overvoltage category /pollution degree	II / 2	II / 2
Protection degree	IP 00	IP 00
Connection terminal	2.5 mm ² screw	2.5 mm ² screw
Status indication	—	—
Dimensions	45x65x93 mm	92x65x93 mm
Approximate weight	—	—
Housing material	UL94V-0 plastic material	UL94V-0 plastic material
Mounting informations	vertical on rails, side by side	vertical on rails, side by side
APPROVALS	CE	CE
ACCESSORIES		
Mounting rail IEC60715 TH35 75	PR003, PR903, PR005, PR953	PR003, PR903, PR005, PR954
Mounting rail IEC60715 TH35 15	PR007, PR907, PR006, PR954	PR007, PR907, PR006, PR955
Marking tag	—	—

- Suitable for LED lamps with limit resistors
- Not suitable for LED lamps fitted with an integrated limitation circuit
- Compact dimensions

NOTE

[1] LEDs light up, with a positive command on the common terminal

The module is suitable only for filament lamps. Some LED lamps are equipped with its own internal electronic circuit, that do not allow to function with the lamp tester.

The lamps powered by alternating current, will have a brightness reduced by the presence of the rectifier diode.



PRESENTATION PURPOSE ONLY

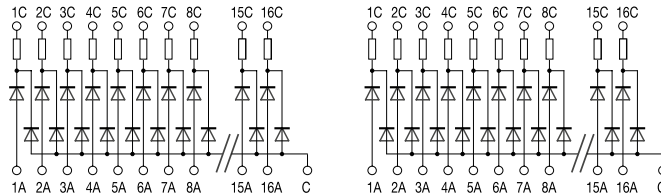

CODE	XCLP08CC	XCLP16CC
TYPE	CLP08CC	CLP16CC
GENERAL TECHNICAL DATA		
Number of poles	8	16
Version	common positive [1]	common positive [1]
Input rated voltage	12...230 Vac/dc	12...230 Vac/dc
Input rated current	100 mA (120 V) / 50 mA (230 V)	100 mA (120 V) / 50 mA (230 V)
Operating temperature	-20...+45°C	-20...+45°C
Standards approvals	—	—
Overvoltage category /pollution degree	II / 2	II / 2
Protection degree	IP 00	IP 00
Connection terminal	2.5 mm ² screw	2.5 mm ² screw
Status indication	—	—
Dimensions	45x65x93 mm	92x65x93 mm
Approximate weight	—	—
Housing material	UL94V-0 plastic material	UL94V-0 plastic material
Mounting informations	vertical on rails, side by side	vertical on rails, side by side
APPROVALS	CE	CE
ACCESSORIES		
Mounting rail IEC60715 TH35 75	PR003, PR903, PR005, PR955	PR003, PR903, PR005, PR956
Mounting rail IEC60715 TH35 15	PR007, PR907, PR006, PR956	PR007, PR907, PR006, PR957
Marking tag	—	—

Accessories

- 3 dimensioni differenti disponibili
- coperture ventilate e non ventilate

NOTE

(1) vedi disegno

(2) Il modulo base CH-B12.5 deve essere chiuso con un coperchio per garantire il grado di protezione IP 20

CODE TYPE	XBS000	XBCA00	XBC000
GENERAL TECHNICAL DATA	CH-S	CH-CA	CH-C
Version	openable front cover	ventilated lateral cover	not ventilated lateral cover
Operating temperature range	max 80 °C	max 80 °C	max 80 °C
Dissipation capability	7 W max.	7 W max.	7 W max.
Protection degree	—	—	—
Connection terminal	—	—	—
Dimensions	(1)	(1)	(1)
Approximate weight	—	—	—
Material	UL94V-0 plastic material	UL94V-0 plastic material	UL94V-0 plastic material
Mounting informations	—	—	—
APPROVALS			
ACCESSORIES			
Mounting rail IEC60715 TH35 75	—	—	—
Mounting rail IEC60715 TH35 15	—	—	—
Marking tag	—	—	—
Plugin jumper	—	—	—
End plate	—	—	—

APPLICATIONS

Electronic circuit for housing CH Series

With its CH (Cabur Housing) series containers, Cabur offers a modular system for creating three different sized boxes (22.5 mm, 35 mm and 45 mm) made up of eight easily assemble parts. The circuit can measure up to 102 x 74 mm and can be inserted onto four columns in the base which hold it in place. The circuit can be additionally secured with a 2.2 x 4.5 mm self-tapping screw, to be screwed into the central column, which also enables the circuit to be smaller in size. Conductor connections are applied using 2.5 mm removable terminal blocks, which are easily available. 16 connection poles are used, with a clearance of 5.08 mm on each side and 10 mm on the front.

The CH-S front closure has an openable inspection window for access to inside the circuit for procedures on potentiometers, jumpers and microswitches. The side closures have a number of incisions which enable them to be cut off with scissors, at a clearance of 5.08 mm, avoiding the expensive grinding typical of other models on the market.

- Expandable module with 6 mm pitch
- 6 spring clamp terminal blocks
- Jumper can be connected on all 4 levels
- Openable front inspection cover

NOTE

- (1) see drawing
 (2) The final module must be closed with the CK/PT end plate, to ensure IP 20 protection degree
 (3) Includes 6 spring clamp terminal blocks
 (4) PTC/4 series, see paragraph accessories for more details

CKB



Ground contact on CKBG



CKBX2



CKB and CKBG

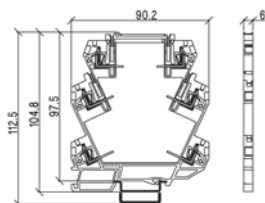

CKBX2

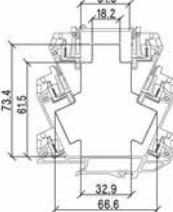

CKPT

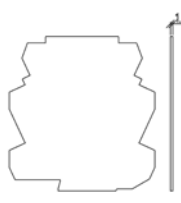

CKS



CKPCB

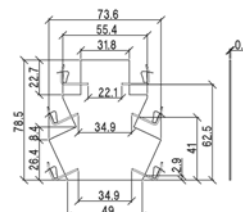

CODE	XCKB	XCKBG	XCKX2
TYPE	CKB (1)	CKBG (1)	CKBX2 (1)
GENERAL TECHNICAL DATA			
Version	base housing	base housing with ground contact	expansion module
Operating temperature range	-40...+ 100°C	-40...+ 100°C	-40...+ 100°C
Dissipation capability	—	—	—
Protection degree	IP 20 (2)	IP 20 (2)	IP 20 (2)
Connection terminal	2.5 mm ² (clamp) (3)	2.5 mm ² (clamp) (3)	2.5 mm ² (clamp) (3)
Dimensions	(1)	(1)	(1)
Approximate weight	20 g	20 g	15 g
Material	UL94V-0 plastic material	UL94V-0 plastic material	UL94V-0 plastic material
Mounting informations	on a rail, syde by side	on a rail, syde by side	on a rail, syde by side
APPROVALS			
ACCESSORIES			
Mounting rail IEC60715 TH35 75	PR/3/AC, PR/3/AC/ZB, PR/3/AS, PR/3/AS/ZB	PR/3/AC, PR/3/AC/ZB, PR/3/AS, PR/3/AS/ZB	PR/3/AC, PR/3/AC/ZB, PR/3/AS, PR/3/AS/ZB
Mounting rail IEC60715 TH35 15	—	—	—
Marking tag	CNU/8/030	CNU/8/031	CNU/8/032
Plugin jumper	PTC/4/.. (4)	PTC/4/.. (4)	PTC/4/.. (4)
End plate	CK/PT	CK/PT	CK/PT

- Expandable module with 6 mm pitch
- 6 spring clamp terminal blocks
- Jumper can be connected on all 4 levels
- Openable front inspection cover

NOTE

- (1) see drawing
- (2) The final module must be closed with the CK/PT end plate, to ensure IP 20 protection degree
- (3) Includes 6 spring clamp terminal blocks
- (4) PTC/4 series, see paragraph accessories for more details

CODE TYPE	CK/PT	XCKPT	CK/S	XCKS
GENERAL TECHNICAL DATA				
Version	end section		openable inspection window	
Operating temperature range	-40...+ 100°C		-40...+ 100°C	
Dissipation capability	—		—	
Protection degree	—		—	
Connection terminal	—		—	
Dimensions	(1)		(1)	
Approximate weight	15 g		1 g	
Material	UL94V-0 plastic material		UL94V-0 plastic material	
Mounting informations	on rails		on rails	
APPROVALS				
ACCESSORIES				
Mounting rail IEC60715 TH35 75	—		—	
Mounting rail IEC60715 TH35 15	—		—	
Marking tag	—		—	
Plugin jumper	—		—	
End plate	—		—	

APPLICATIONS

With its CK series housing, Cabur offers a modular system for creating terminal blocks of gradually increasing widths for housing simple components such as diodes and resistors or more complex circuits with or without the support of a printed circuit board.

Housing requires the following components:

- one base housing available in two versions: CKB and CKBG, the latter supplied with an electrical contact to the metal rail for connecting the internal circuit to ground. The rail ground contact can carry an impulse current of 5 KA (impulse 8/20). Both models have an external width of 6 mm and an internal width of 5 mm and have 6 spring connections, 4 of which are connectable to a jumper.
- one or more CKBX2 expansion cards similar to the standard model, i.e. with an external width of 6 mm and a central cavity that allows bulky components to overlap the base outline, can also be supplied with a 6-connection expansion, 4 of which connectable to a jumper;
- available with the CK/S openable inspection window for frontal closure; the opening is in any case sized to ensure protection degree IP20 even without using the inspection window;
- the final module must be provided with the CK/PT end section, which ensures protection degree IP20;
- also available with the CK/PCB printed strip board, useful for custom applications in which low volumes make it infeasible to produce a dedicated printed circuit board or for creating affordable prototypes.

• Suitable for “CK” series

NOTE

Example of a jumper bridge cut into nine poles
Current capability is referred to the metal jumper, number of poles and terminals can reduce this value.



CODE	PTCCK42
TYPE	PTC/CK/42
GENERAL TECHNICAL DATA	
Version	—
Number of poles	42
Pitch	6 mm
Current capability	32 A
Approximate weight	27 g (42 poles)
Material	copper-tin alloy

APPROVALS

• Suitable for “CW...7” series

NOTE

Current capability is referred to the metal jumper, number of poles and terminals can reduce this value.



CODE	X766802	X766803	X766804
TYPE	CWBK 7-0802	CWBK 7-0803	CWBK 7-0804
GENERAL TECHNICAL DATA			
Version	red	white	blue
Number of poles	16	16	16
Pitch	6.2 mm	6.2 mm	6.2 mm
Current capability	16 A	16 A	16 A
Approximate weight	4 g	4 g	4 g
Material	—	—	—

APPROVALS

- Suitable for "CWRE" series

NOTE

Current capability is referred to the metal jumper, number of poles and terminals can reduce this value.



CODE	X766813	XCMB16B	XCMB27B
TYPE	CWBK 7-0813	CMB16B	CMB27B
GENERAL TECHNICAL DATA			
Version	blue	black	black
Number of poles	20	8	8
Pitch	6.2 mm	16 mm	27 mm
Current capability	16 A	16 A	16 A
Approximate weight	6 g	3 g	3 g
Material	—	—	—
APPROVALS			



CODE TYPE	CDIN-2	XCDIN2	CDIN-4	XCDIN4
GENERAL TECHNICAL DATA				
Material	P13-FE00		aluminium	
Mounting information	screws or rivets		screws or rivets	
Mounting rail (IEC60715/TH35-7.5)	PR/3/AC, PR/3/AC/ZB, PR/3/AS, PR/3/AS/ZB		PR/3/AC, PR/3/AC/ZB, PR/3/AS, PR/3/AS/ZB	
Mounting rail (IEC60715/TH35-15)	—		—	



CODE TYPE	CDIN-6	XCDIN6	CDINM45	XCDINM45
GENERAL TECHNICAL DATA				
Material	P13-FE00		P13-FE00	
Mounting information	screws or rivets		screws or rivets	
Mounting rail (IEC60715/TH35-7.5)	PR/3/AC, PR/3/AC/ZB, PR/3/AS, PR/3/AS/ZB		PR/3/AC, PR/3/AC/ZB, PR/3/AS, PR/3/AS/ZB	
Mounting rail (IEC60715/TH35-15)	—		—	

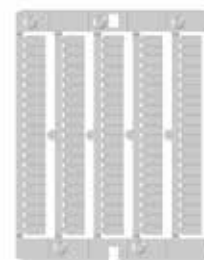
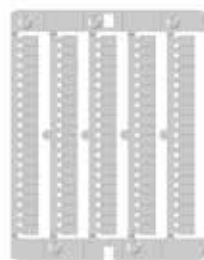

NOTE

Targhette identificative bianche da inserire nello slot dedicato. Può essere scritto manualmente o stampato utilizzando un sistema di marcatura industriale. Oltre alle targhette vuote, sono disponibili targhette con caratteri alfanumerici e con i simboli elettrici più comuni. Per ulteriori informazioni, consultare il catalogo Sistemi di marcatura industriale.

CODE	NU0851	NUPUTUK50
TYPE	CNU/8/51	NUPUTUK50
GENERAL TECHNICAL DATA		
Version	white, neutral	white, neutral
Material	polycarbonate	polycarbonate

MOUNTING RAILS COMPLIANT WITH IEC 60715/TH35 - 7.5

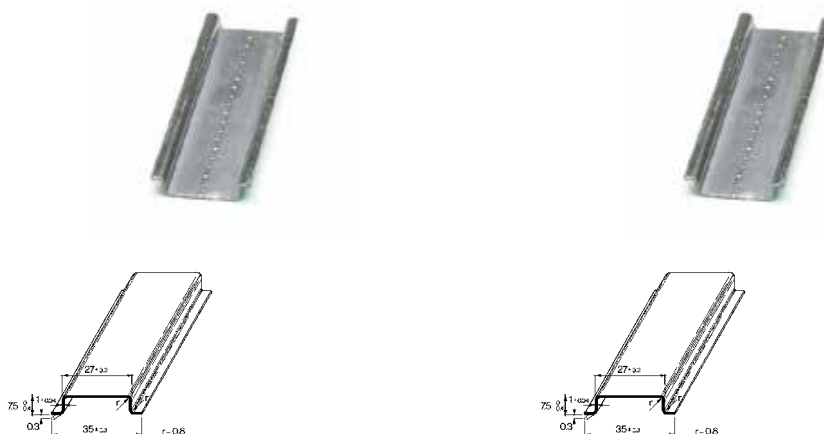

CODICE SIGLA	PR/3/AC	PR003	PR/3/AC/ZB	PR903
DATI TECNICI GENERALI				
Versione	passivated		white zinc-plated "SENDZMIR" system	
Materiale	steel		steel	

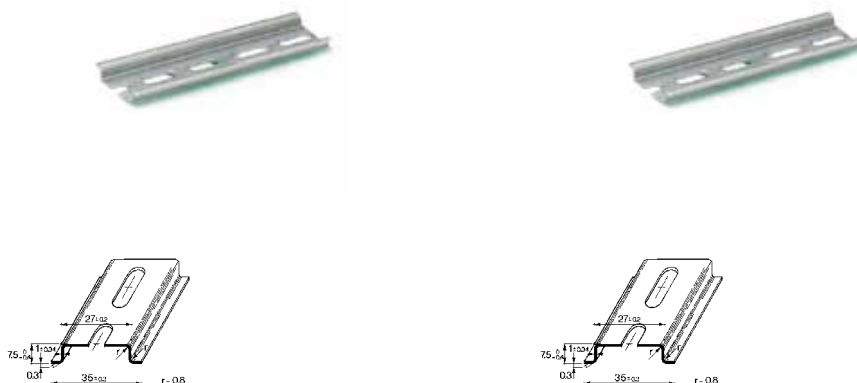

CODICE SIGLA	PR/3/AS	PR005	PR/3/AS/ZB	PR905
DATI TECNICI GENERALI				
Versione	passivated with holes		white zinc-plated "SENDZMIR" system with holes	
Materiale	steel		steel	

MOUNTING RAILS COMPLIANT WITH IEC 60715/TH35 - 7.5

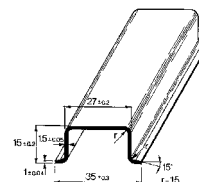
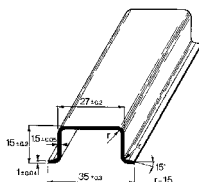

CODE	PR007	PR007
TYPE	PR/3/PP	PR/3/PP/ZB
GENERAL TECHNICAL DATA		
Version	passivated	white zinc-plated "SENDZMIR" system
Material	steel	steel

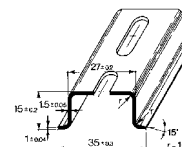
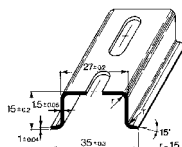

CODE	PR006	PR906
TYPE	PR/3/PA	PR/3/PA/ZB
GENERAL TECHNICAL DATA		
Version	passivated with holes	white zinc-plated "SENDZMIR" system with holes
Material	steel	steel

Multiple horizontal grey bars for taking notes.

ISPD275AC1PNPE	74	XCDIN2	188	XCONTA819P	101	XCSL1072W024VAA	27	XIF16PML	165
ISPD440AC3PNPE	74	XCDIN4	188	XCONTA839P	102	XCSL1120W024VAA	27	XIF16PMS	165
NU0851	189	XCDIN6	188	XCPC20M	170	XCSL1480W024VAA	30	XIF20PML	166
NUPUTUK50	189	XCDINM45	188	XCPC26M	170	XCSL1480W024VAB	31	XIF20PMS	166
PR003	190	XCDM08AC	176	XCPC34M	170	XCSL1480W024VGA	30	XIF26PML	167
PR005	190	XCDM08CC	177	XCPC40M	171	XCSL1480W048VAA	32	XIF26PMS	167
PR006	191	XCDM08CS	175	XCPC50M	171	XCSL1480W048VAB	33	XIF34PML	168
PR007	191	XCDM16AC	176	XCPC60M	171	XCSL1480W048VGA	32	XIF34PMS	168
PR903	190	XCDM16CC	177	XCPC64M	172	XCSL1480W072VAA	34	XIF40PML	169
PR905	190	XCDM16CS	175	XCPD25F	160	XCSL1480W072VAB	35	XIF40PMS	169
PR906	191	XCDM24AC	176	XCPD25M	160	XCSL1480W072VGA	34	XISD09FM	156
PTCCK42	186	XCDM24CC	177	XCPD37F	161	XCSL3480W024VAA	36	XISD09PF	156
X756321	99	XCDM24CS	175	XCPD37M	161	XCSL3480W024VAB	37	XISD09PM	156
X756340	100	XCEPD1	73	XCPD50F	162	XCSL3480W024VGA	36	XISD15FM	157
X756360	105	XCIO4IMB	111	XCPD50M	162	XCSL3480W048VAA	38	XISD15PF	157
X756370	106	XCIO4RLYMB	112	XCR41	138	XCSL3480W048VAB	39	XISD15PM	157
X756516	93	XCIO4RMB	111	XCR42SC	138	XCSL3480W048VGA	38	XISD25FM	158
X756524	104	XCIO4TMB	112	XCR81	138	XCSL3480W072VAA	40	XISD25PF	158
X756526	98	XCIO4VMB	111	XCR83	140	XCSL3480W072VAB	41	XISD25PM	158
X756530	95	XCKB	184	XCRE41	139	XCSL3480W072VGA	40	XISD37FM	159
X756531	95	XCKBG	184	XCRE42SC	139	XCSR2M20AA	66	XISD37PF	159
X756532	95	XCKPT	185	XCRE81	139	XCSR2M40AA	66	XISD37PM	159
X756533	96	XCKR16	129	XCRE83	140	XCSU120S	62	XMBC2K	71
X756534	96	XCKR25	129	XCSA120BC	55	XCSU240S	63	XNPNPNP	109
X756535	96	XCKS	185	XCSA120CB	55	XCSUPS1	61	XO332060	144
X756536	97	XCKS1S	149	XCSA120CC	56	XCSUPS2	61	XO332240	144
X756537	97	XCKS024DC024DC03	147	XCSA120DC	56	XCSW121B	44	XR041E24	132
X756538	97	XCKS024DC024DC05	147	XCSA240FC	57	XCSW121C	44	XR041EAD	133
X756539	94	XCKS024DC024DC10	147	XCSBC	60	XCSW241B	45	XR041S24F	152
X756540	103	XCKS024DC230AC05	148	XCSBD	65	XCSW241C	45	XR041U24F	134
X756541	103	XCKX2	184	XCSC120B	64	XCSW241DP	46	XR042E24	135
X756542	103	XCL1R	58	XCSC120C	64	XCSW481C	47	XR042EAD	136
X756816	101	XCL5R	58	XCSD30F	15	XCSW481D	47	XR042S24	150
X756844	102	XCLP08CC	180	XCSD1015W012VAA	13	XCSW481G	48	XR042T24	151
X766082	149	XCLP16CC	180	XCSD1015W024VAA	13	XCSW960CP	48	XR081E24	132
X766083	149	XCLT08AC	178	XCSD1030W012VAA	14	XF03DKBG5B	82	XR081EAD	133
X766184	108	XCLT08CC	179	XCSD1030W024VAA	14	XF03DPCG5C	84	XR081S24F	152
X766802	186	XCLT16AC	178	XCSD1072W012VAA	16	XF06DKBG5B	82	XR081U24F	134
X766803	186	XCLT16CC	179	XCSD1072W024VAA	16	XF06DPCG5C	84	XR082E24	135
X766804	186	XCM1A012	125	XCSF30C	18	XF07TDVST2	76	XR082EAD	136
X766813	187	XCM1A024	125	XCSF85B	20	XF10TYG9	80	XR082S24	150
X766842	130	XCM1A120	125	XCSF85C	19	XF12DKBG5B	82	XR082T24	151
X766845	130	XCM1A230	126	XCSF85CP	19	XF12DPCG5C	84	XR161E24	132
X766846	131	XCM1C012	120	XCSF120C	21	XF16DKCG5B	83	XR161EAD	133
X766847	131	XCM1C024	120	XCSF120CP	21	XF16DPCG5C	85	XR161S24F	152
X766848	130	XCM1C048	120	XCSF120DP	22	XF16TDVST2	76	XR161U24F	134
XAR6	59	XCM1C110	121	XCSF240C	23	XF20DKCG5B	83	XR162E24	135
XBB125	182	XCM1S024	145	XCSF240CP	23	XF20DPCG5C	85	XR162EAD	136
XBC000	183	XCM1S024E	145	XCSF240DP	24	XF20TYS9	80	XR162S24	150
XBC010	182	XCM1T024	146	XCSF500C	25	XF30DKCS5B	83	XR162T24	151
XBC225	182	XCM1T024E	146	XCSF500D	25	XF30DPGS5C	85	XRE1024D	119
XBC325	182	XCM2A012	127	XCSG481C	50	XF30TDVST2	76	XRE1824D	119
XBCA00	183	XCM2A024	127	XCSG500C	50	XF36TYT8	81	XRE2024D	119
XBRIRS485CP	113	XCM2A120	127	XCSG720C	51	XF42TDVST2	77	XRF1024D	118
XBRIRS485ET	113	XCM2A230	128	XCSG960C	51	XF50TYT8	81	XRF1824D	118
XBRIRS485WI	113	XCM2C012	122	XCSG960D	52	XF55TDVST2	77	XRFA024D	118
XBS000	183	XCM2C024	122	XCSG960G	52	XF75TDVST2	77	XRMP081CM	137
XCAPIPO3	92	XCM2C048	122	XCSG2401C	53	XF100TDVST2	78	XSWET5PU	114
XCCI001MB	67	XCM2C110	123	XCSG2401D	53	XF100TYT8	81	XSWET8PU	114
XCCIS2	107	XCM4C024	124	XCSG2401G	54	XF150TDS84C	79		
XCCM08CV	173	XCMB16B	187	XCSG2401R	54	XF180TDS84C	79		
XCCM08SV	174	XCMB27B	187	XCSL85C	28	XIF10PML	163		
XCCM16CV	173	XCONAA516P	93	XCSL120C	28	XIF10PMS	163		
XCCM16SV	174	XCONAA539P	94	XCSL240C	29	XIF14PML	164		
XCCM24SV	174	XCONPC528P	98	XCSL481C	29	XIF14PMS	164		

AR6	59	CM1C048	120	CSF120CP	21	CWBK 7-0802	186	ISD25PF	158
BRI—RS485—CP	113	CM1C0110	121	CSF120DP	22	CWBK 7-0803	186	ISD25PM	158
BRI—RS485—ET	113	CM1S024	145	CSF240C	23	CWBK 7-0804	186	ISD37FM	159
BRI—RS485—WI	113	CM1S024E (1)	145	CSF240CP	23	CWBK 7-0813	187	ISD37PF	159
CAPIPO3	92	CM1T024	146	CSF240DP	24	CWCV 7-6184	108	ISD37PM	159
CCI001MB	67	CM1T024E (1)	146	CSF500C	25	CWNAA-7-0539	94	ISPD275AC1PNPE	74
CCIS-2	107	CM2A012	127	CSF500D	25	CWNFA 6-0524	104	ISPD440AC3PNPE	74
CCM08CV	173	CM2A024	127	CSG481C	50	CWOT 6-2083 (1)	149	LCON AASP	99
CCM08SV	174	CM2A120	127	CSG500C	50	CWOT 6-6082 (1)	149	LCONALS	105
CCM16CV	173	CM2A230	128	CSG720C	51	CWPAA 7-0526	98	LCONTAD	100
CCM16SV	174	CM2C012	122	CSG960C	51	CWPT 6-0816	101	LCONTLS	106
CCM24SV	174	CM2C024	122	CSG960D	52	CWRE7-0842	130	MBC2K (1)	71
CDIN-2	188	CM2C048	122	CSG960G	52	CWRE7-0845 (1)	130	NUPUTUK50	189
CDIN-4	188	CM2C0110	123	CSG2401C	53	CWRE7-0846	131	O332060	144
CDIN-6	188	CM4C024	124	CSG2401D	53	CWRE7-0847	131	O332240	144
CDINM45	188	CMB16B	187	CSG2401G	54	CWRE7-0848 (1)	130	PR/3/AC	190
CDM08AC	176	CMB27B	187	CSG2401R	54	CWTH 6-0844	102	PR/3/AC/ZB	190
CDM08CC	177	CNU/8/51	189	CSL1-072W/024V/AA	27	CWUAA 6-0516	93	PR/3/AS	190
CDM08CS	175	CON-AA-516P (1)	93	CSL1-120W/024V/AA	27	F03DKBG5B (1)	82	PR/3/AS/ZB	190
CDM16AC	176	CON-AA-539P (1)	94	CSL1-480W/024V/AA (1)	30	F03DPCG5C (1)	84	PR/3/PA	191
CDM16CC	177	CON-PC-528P (2)	98	CSL1-480W/024V/AB (3)	31	F06DKBG5B (1)	82	PR/3/PA/ZB	191
CDM16CS	175	CON-TA-819P (2)	101	CSL1-480W/024V/GA (2)	30	F06DPCG5C (1)	84	PR/3/PP	191
CDM24AC	176	CON-TA-839P (1)	102	CSL1-480W/048V/AA (1)	32	F07TDVST2	76	PR/3/PP/ZB	191
CDM24CC	177	CPC20M	170	CSL1-480W/048V/AB (3)	33	F10TYG9 (1)	80	PTC/CK/42	186
CDM24CS	175	CPC26M	170	CSL1-480W/048V/GA (2)	32	F12DKBG5B	82	R41E24	132
CEP-D1	73	CPC34M	170	CSL1-480W/072V/AA (1)	34	F12DPCG5C	84	R41EAD	133
CH-B12.5	182	CPC40M	171	CSL1-480W/072V/AB (3)	35	F16DKCG5B	83	R41S24F (1)	152
CH-C	183	CPC50M	171	CSL1-480W/072V/GA (2)	34	F16DPCG5C	85	R41U24F	134
CH-C10	182	CPC60M	171	CSL3-480W/024V/AA (1)	36	F16TDVST2	76	R42E24	135
CH-C22.5	182	CPC64M	172	CSL3-480W/024V/AB (3)	37	F20DKCG5B (1)	83	R42EAD	136
CH-C32.5	182	CPD25F	160	CSL3-480W/024V/GA (2)	36	F20DPCG5C	85	R42S24 (1)	150
CH-CA	183	CPD25M	160	CSL3-480W/048V/AA (1)	38	F20TYS9 (1)	80	R42T24 (1)	151
CH-S	183	CPD37F	161	CSL3-480W/048V/AB (3)	39	F30DKCS5B	83	R81E24	132
CI-NPN/PNP	109	CPD37M	161	CSL3-480W/048V/GA (2)	38	F30DPGS5C	85	R81EAD	133
CIO4IMB	111	CPD50F	162	CSL3-480W/072V/AA (1)	40	F30TDVST2	76	R81S24F (1)	152
CIO4RLYMB	112	CPD50M	162	CSL3-480W/072V/AB (3)	41	F36TYT8 (1)	81	R81U24F	134
CIO4RMB	111	CR4-1	138	CSL3-480W/072V/GA (2)	40	F42TDVST2	77	R82E24	135
CIO4TMB	112	CR4-2SC	138	CSL85C	28	F50TYT8 (1)	81	R82EAD	136
CIO4VMB	111	CR8-1	138	CSL120C	28	F55TDVST2	77	R82S24 (1)	150
CKB (1)	184	CR8-3	140	CSL240C	29	F75TDVST2	77	R82T24 (1)	151
CKBG (1)	184	CRE4-1	139	CSL481C	29	F100TDVST2	78	R161E24	132
CKBX2 (1)	184	CRE4-2SC	139	CSR-2M/20/AA	66	F100TYT8 (1)	81	R161EAD	133
CK/PT	185	CRE8-1	139	CSR-2M/40/AA	66	F150TDS84C (1)	79	R161S24F (1)	152
CKR16	129	CRE8-3	140	CSU120S	62	F180TDS84C (1)	79	R161U24F	134
CKR25 (1)	129	CSA120BC	55	CSU240S	63	IF10PML	163	R162E24	135
CK/S	185	CSA120CB	55	CS-UPS1	61	IF10PMS	163	R162EAD	136
CKS1S (1)	149	CSA120CC	56	CS-UPS2	61	IF14PML	164	R162S24 (1)	150
CKS-024DC/024DC/03	147	CSA120DC	56	CSW121B	44	IF14PMS	164	R162T24 (1)	151
CKS-024DC/024DC/05	147	CSA240FC	57	CSW121C	44	IF16PML	165	RE1024D	119
CKS-024DC/024DC/10	147	CSBC	60	CSW241B	45	IF16PMS	165	RE1824D	119
CKS-024DC/230AC/05	148	CSBD	65	CSW241C	45	IF20PML	166	RE2024D	119
CL1R	58	CSC120B	64	CSW241DP	46	IF20PMS	166	RF1024D (1)	118
CL5R	58	CSC120C	64	CSW481C	47	IF26PML	167	RF1824D	118
CLP08CC	180	CSD1-015W/012V/AA	13	CSW481D	47	IF26PMS	167	RFA024D (1)	118
CLP16CC	180	CSD1-015W/024V/AA	13	CSW481G	48	IF34PML	168	RMP081CM	137
CLT08AC	178	CSD1-030W/012V/AA	14	CSW960CP	48	IF34PMS	168	SWET-5PU	114
CLT08CC	179	CSD1-030W/024V/AA	14	CWAA 7-0530	95	IF40PML	169	SWET-8PU	114
CLT16AC	178	CSD1-072W/012V/AA	16	CWAA 7-0531	95	IF40PMS	169	WAA 7-0540	103
CLT16CC	179	CSD1-072W/024V/AA	16	CWAA 7-0532	95	ISD09FM	156	WAA 7-0541	103
CM1A012	125	CSD30F	15	CWAA 7-0533	96	ISD09PF	156	WAA 7-0542	103
CM1A024	125	CSF30C	18	CWAA 7-0534	96	ISD09PM	156		
CM1A120	125	CSF85B	20	CWAA 7-0535	96	ISD15FM	157		
CM1A230	126	CSF85C	19	CWAA 7-0536	97	ISD15PF	157		
CM1C012	120	CSF85CP	19	CWAA 7-0537	97	ISD15PM	157		
CM1C024	120	CSF120C	21	CWAA 7-0538	97	ISD25FM	158		

Blank lined area for notes.

A series of 18 horizontal grey bars, each representing a line of text in a document template.



SOLUZIONI PER
L'AUTOMAZIONE
ED IL CONTROLLO



SOLUZIONI PER
LA CONNESSIONE NEI
QUADRI ELETTRICI



SOLUZIONI PER
LE ENERGIE
RINNOVABILI



SOLUZIONI PER
LA SIGLATURA
INDUSTRIALE



D021G20A

Cabur Srl

Sede Generale (Italia)

17041 - Altare (SV)

Località Isola Grande, 45

T. +39 019 58999.1

F. +39 019 58999233

www.cabur.it

info@cabur.it

Cabur Romania Srl

Romanian Branch

Strada Calea Plevnei nr. 139

Corp B camera 25,26 sector 6

Bucaresti

T. +40 (21)31.17.140

F. +40 (21)31.17.140

www.cabur.eu

alexandru.cazacu@cabur.eu