

User's guide

IXA

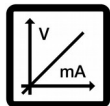

Analogue output

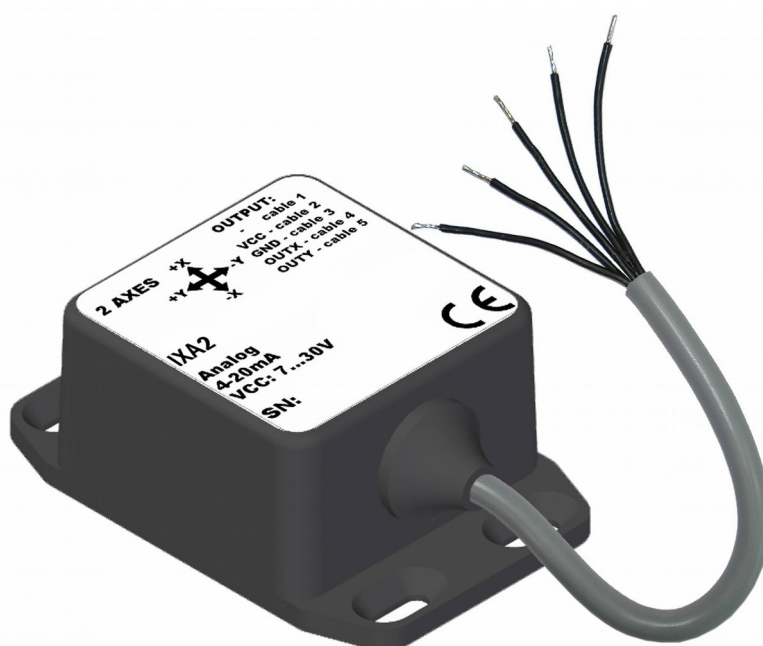

lika

Smart encoders & actuators

This publication was produced by Lika Electronic s.r.l. 2016. All rights reserved. Tutti i diritti riservati. Alle Rechte vorbehalten. Todos los derechos reservados. Tous droits réservés.

This document and information contained herein are the property of Lika Electronic s.r.l. and shall not be reproduced in whole or in part without prior written approval of Lika Electronic s.r.l. Translation, reproduction and total or partial modification (photostat copies, film and microfilm included and any other means) are forbidden without written authorisation of Lika Electronic s.r.l.

The information herein is subject to change without notice and should not be construed as a commitment by Lika Electronic s.r.l. Lika Electronic s.r.l. reserves the right to make all modifications at any moments and without forewarning.

This manual is periodically reviewed and revised. As required we suggest checking if a new or updated edition of this document is available at Lika Electronic s.r.l.'s website. Lika Electronic s.r.l. assumes no responsibility for any errors or omissions in this document. Critical evaluation of this manual by the user is welcomed. Your comments assist us in preparation of future documentation, in order to make it as clear and complete as possible. Please send an e-mail to the following address info@lika.it for submitting your comments, suggestions and criticisms.

The logo for Lika Electronic s.r.l. consists of the word "lika" in a bold, lowercase, sans-serif font. The letter "i" has a dot above it. The logo is positioned in the bottom right corner of the page.

General contents



User's guide.....	1
General contents.....	3
Typographic and iconographic conventions.....	4
Preliminary information.....	5
1 Safety summary.....	6
1.1 Safety.....	6
1.2 Electrical safety.....	6
1.3 Mechanical safety.....	7
2 Identification.....	8
3 Mechanical installation.....	9
3.1 Overall dimensions (Figure 1).....	9
3.2 Installation (Figure 2 and Figure 3).....	10
4 Electrical connections.....	12
4.1 Ground connection.....	12
4.2 Electrical connections.....	12
4.3 M12 5-pin connector.....	12
4.4 Connections schemes.....	13
4.5 Output characteristics.....	14
4.5.1 AI1 current output characteristics.....	14
4.5.2 AV1 voltage output characteristics.....	15

Typographic and iconographic conventions

In this guide, to make it easier to understand and read the text the following typographic and iconographic conventions are used:

- parameters and objects both of Lika device and interface are coloured in **GREEN**;
- alarms are coloured in **RED**;
- states are coloured in **FUCSIA**.

When scrolling through the text some icons can be found on the side of the page: they are expressly designed to highlight the parts of the text which are of great interest and significance for the user. Sometimes they are used to warn against dangers or potential sources of danger arising from the use of the device. You are advised to follow strictly the instructions given in this guide in order to guarantee the safety of the user and ensure the performance of the device. In this guide the following symbols are used:

	This icon, followed by the word WARNING , is meant to highlight the parts of the text where information of great significance for the user can be found: user must pay the greatest attention to them! Instructions must be followed strictly in order to guarantee the safety of the user and a correct use of the device. Failure to heed a warning or comply with instructions could lead to personal injury and/or damage to the unit or other equipment.
	This icon, followed by the word NOTE , is meant to highlight the parts of the text where important notes needful for a correct and reliable use of the device can be found. User must pay attention to them! Failure to comply with instructions could cause the equipment to be set wrongly: hence a faulty and improper working of the device could be the consequence.
	This icon is meant to highlight the parts of the text where suggestions useful for making it easier to set the device and optimize performance and reliability can be found. Sometimes this symbol is followed by the word EXAMPLE when instructions for setting parameters are accompanied by examples to clarify the explanation.

Preliminary information

This guide is designed to provide the most complete information the operator needs to correctly and safely install and operate the **IXA series inclinometers with analogue interface**.

Inclinometers are instruments designed to measure the levelling and pitch and roll angles for motion control or safety purposes.

IXA series inclinometers are equipped with analogue interface (while IXB and IXC series inclinometers are equipped with CANopen interface).

Analogue inclinometers are available with either 1-axis or 2-axis operation. IXA1 inclinometers are 1-axis sensors; IXA2 inclinometers are 2-axis sensors.

The measurement range is up to ± 360 deg in 1-axis models and from ± 5 deg up to ± 60 deg in 2-axis models.

1 Safety summary



1.1 Safety

- Always adhere to the professional safety and accident prevention regulations applicable to your country during device installation and operation;
- installation and maintenance operations have to be carried out by qualified personnel only, with power supply disconnected and stationary mechanical parts;
- device must be used only for the purpose appropriate to its design: use for purposes other than those for which it has been designed could result in serious personal and/or the environment damage;
- high current, voltage and moving mechanical parts can cause serious or fatal injury;
- warning ! Do not use in explosive or flammable areas;
- failure to comply with these precautions or with specific warnings elsewhere in this manual violates safety standards of design, manufacture, and intended use of the equipment;
- Lika Electronic assumes no liability for the customer's failure to comply with these requirements.



1.2 Electrical safety

- Turn OFF power supply before connecting the device;
- connect according to explanation in the "Electrical connections" section;
- wires of output signals which are not used must be cut at different lengths and insulated singularly;
- in compliance with 2014/30/EU norm on electromagnetic compatibility, following precautions must be taken:
 - before handling and installing the equipment, discharge electrical charge from your body and tools which may come in touch with the device;
 - power supply must be stabilized without noise; install EMC filters on device power supply if needed;
 - always use shielded cables (twisted pair cables whenever possible);
 - avoid cables runs longer than necessary;
 - avoid running the signal cable near high voltage power cables;
 - mount the device as far as possible from any capacitive or inductive noise source; shield the device from noise source if needed;
 - to guarantee a correct working of the device, avoid using strong magnets on or near by the unit;



- minimize noise by connecting the shield and/or the connector housing and/or the frame to ground. Make sure that ground is not affected by noise. The connection point to ground can be situated both on the device side and on user's side. The best solution to minimize the interference must be carried out by the user.



1.3 Mechanical safety

- Install the device following strictly the information in the "Mechanical installation" section;
- mechanical installation has to be carried out with stationary mechanical parts;
- do not disassemble the unit;
- do not tool the unit;
- delicate electronic equipment: handle with care; do not subject the device and the shaft to knocks or shocks;
- respect the environmental characteristics of the product;
- always comply with the mounting positions indicated in the "Mechanical installation" section according to the model to be installed (1-axis or 2-axis inclinometer).

2 Identification

Device can be identified through the **order code** and the **serial number** printed on the label applied to its body. Information is listed in the delivery document too. Please always quote the order code and the serial number when reaching Lika Electronic for purchasing spare parts or needing assistance. For any information on the technical characteristics of the product refer to the technical catalogue.



Warning: devices having order code ending with "/Sxxx" may have mechanical and electrical characteristics different from standard and be supplied with additional documentation for special connections (Technical info).

3 Mechanical installation



WARNING

Installation and maintenance operations must be carried out by qualified personnel only, with power supply disconnected and mechanical parts absolutely in stop.

3.1 Overall dimensions (Figure 1)

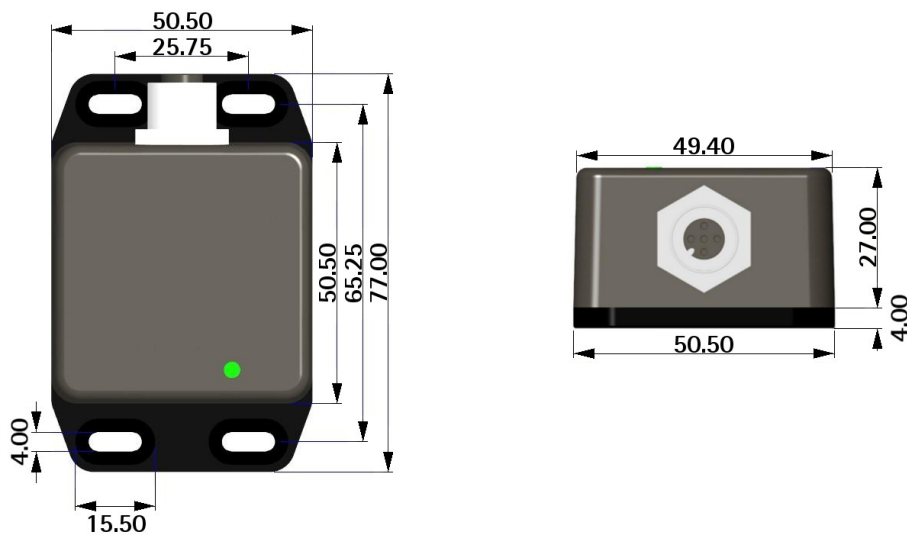

(values are expressed in mm)

Figure 1 - IXA inclinometers – Overall dimensions

3.2 Installation (Figure 2 and Figure 3)

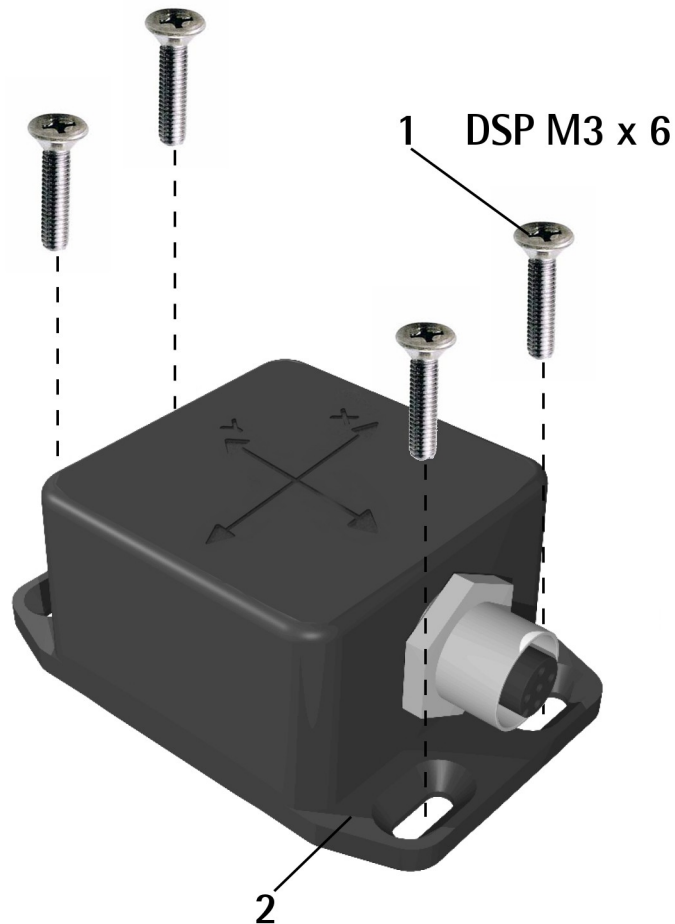

Figure 2 - Installation

Install the inclinometer as shown in Figure 2 and Figure 3:

- tighten the flange **2** using four M3 x 6 min. DSP screws **1**;
- max. tightening torque: **1.1 Nm**;
- 1-axis inclinometers must be mounted on a vertical plane; 0° position is achieved by mounting the connector on the left side (see Figure 3);
- 2-axis inclinometers must be mounted on an horizontal plane (see Figure 3);
- 2-axis inclinometers can be mounted also upside down.



WARNING

Always comply with the mounting positions indicated in Figure 3 according to the model to be installed or the selected operational mode (1-axis inclinometer or 2-axis inclinometer).

1 axis

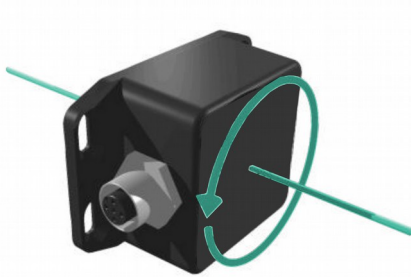

Vertical mounting

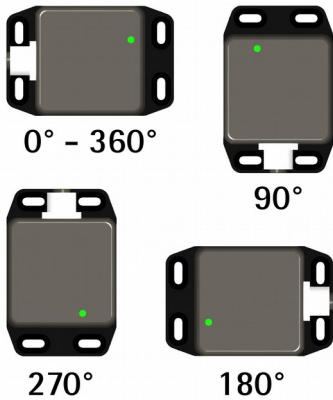

2 axes

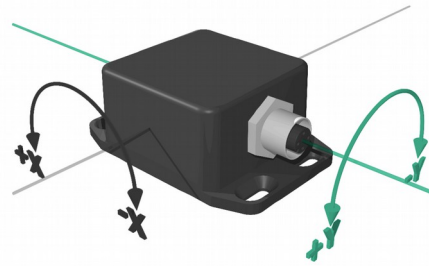

Horizontal mounting

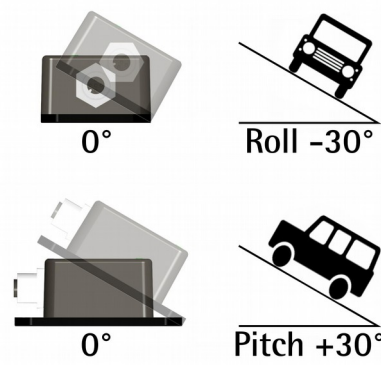
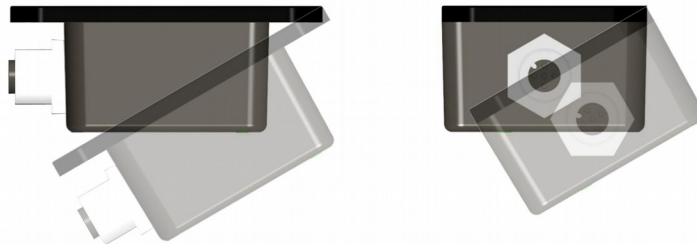

Figure 3 - Mounting positions



NOTE

2-axis inclinometers can be mounted also upside down as shown in the Figure.



4 Electrical connections



WARNING

Electrical connections must be carried out by qualified personnel only, with power supply disconnected and mechanical parts absolutely in stop.

4.1 Ground connection

Minimize noise by connecting the shield or the connector housing to ground. Make sure that ground is not affected by noise. The connection point to ground can be situated both on the device side and on user's side. The best solution to minimize the interference must be carried out by the user. You are advised to provide the ground connection as close as possible to the inclinometer.

4.2 Electrical connections

Analogue signals AI1 ¹ AV1 ²	M12 5-pin	5-wire cable
n.c.	1	1
+7Vdc +30Vdc	2	2
0Vdc	3	3
Analogue output (X axis) ³	4	4
Analogue output (Y axis) ⁴	5	5

- 1 4-20mA analogue current output, see IXAx-AI1-... order code
- 2 0.5-4.5V analogue voltage output, see IXAx-AV1-... order code
- 3 X axis in dual-axis (IXA2) and single-axis models (IXA1)
- 4 Y axis in dual-axis models (IXA2), not used in single-axis models (IXA1)

4.3 M12 5-pin connector

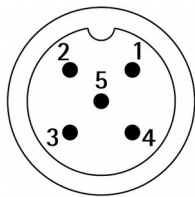

M12 5-pin male connector
(frontal side)

4.4 Connections schemes

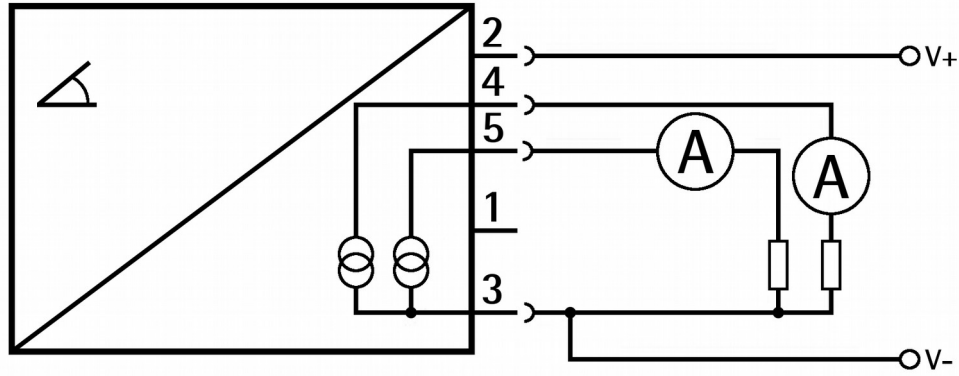

Figure 4: AI1 current output connections scheme

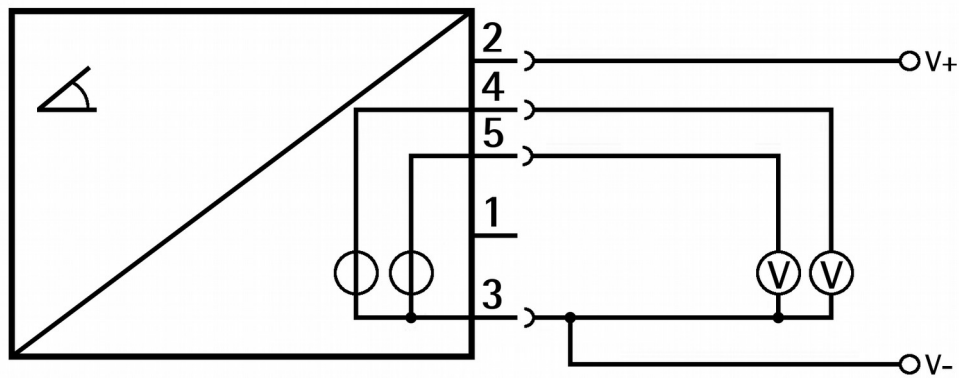

Figure 5: AV1 voltage output connections scheme

4.5 Output characteristics

4.5.1 AI1 current output characteristics

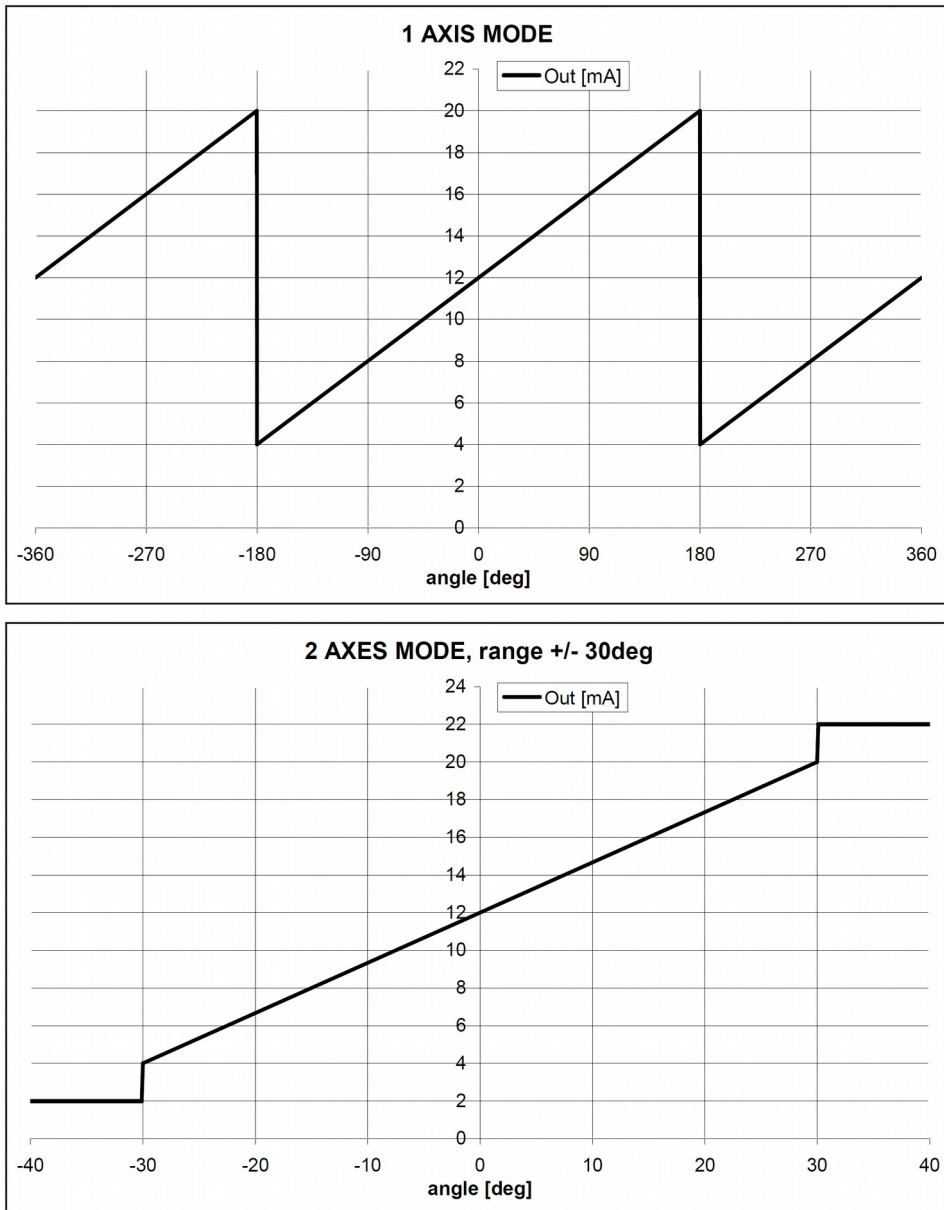

Figure 6: AI1 current output characteristics

4.5.2 AV1 voltage output characteristics

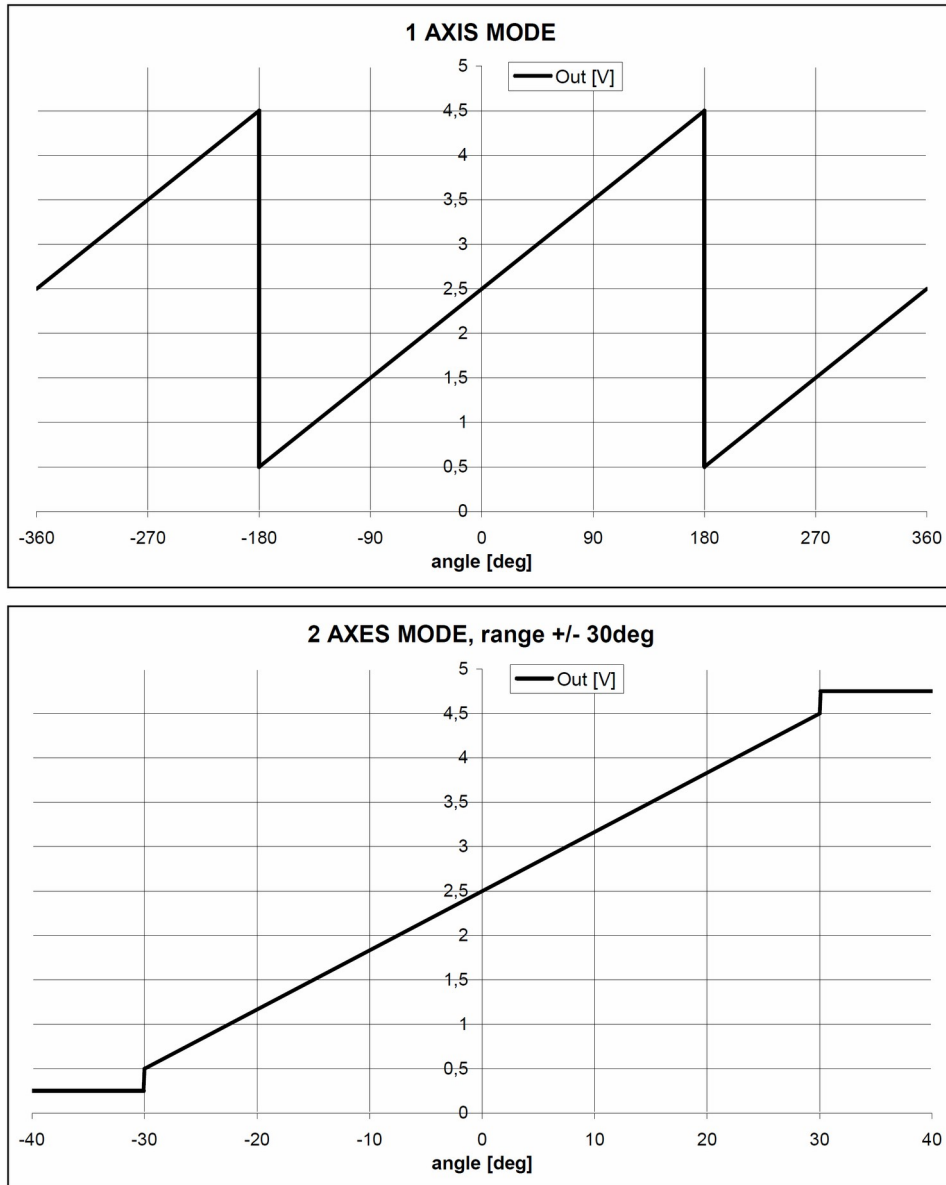
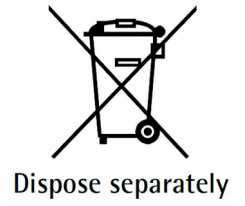

Figure 7: AV1 voltage output characteristics

Document release	Release date	Description	HW	SW	Interface
1.0	12.10.2016	First issue	1	1.0	-



lika

Lika Electronic

Via S. Lorenzo, 25 • 36010 Carrè (VI) • Italy

Tel. +39 0445 806600

Fax +39 0445 806699



info@lika.biz • www.lika.biz