

Structure

- Set Screw Type → P.xxxx

MJC-*-***** Tight Fit

MJC-*-E***** Easy Fit

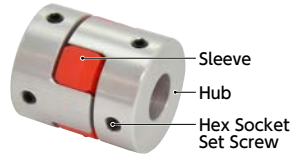

- Clamping Type → P.xxxx

MJC-*CS***** Tight Fit

MJC-*CS-E***** Easy Fit



- Set Screw + Key Type → P.xxxx

MJC-*K***** Tight Fit

MJC-*K-E***** Easy Fit



- Clamping + Key Type → P.xxxx

MJC-*CSK***** Tight Fit

MJC-*CSK-E***** Easy Fit



Material/Finish



	MJC / MJC-CS / MJC-K / MJC-CSK
Hub	A2017 Alumite Treatment
Sleeve	Polyurethane
Hex Socket Set Screw	SCM435 Ferrosferric Oxide Film (Black)
Hex Socket Head Cap Screw	SCM435 Ferrosferric Oxide Film (Black)

● Sleeve

Outside Diameter: φ14 - φ30



Tight Fit



Easy Fit

Outside Diameter: φ40



Tight Fit



Easy Fit

Outside Diameter: φ55 - φ95



Tight Fit



Easy Fit

● New and Old Part Number

The part numbers for **MJC-CS** and **MJC-CSK** have been changed. The new and old part numbers are as below.

New Part Number	Old Part Number
MJC-CS	MJC-C
MJC-CSK	MJC-CK

● Specification Change

The specifications for these products have been changed.

- Change 1 Alumite treatment has been added to the surface.
- Change 2* For **MJC-CS** and **MJC-CSK** with outside diameter of φ40 mm or more, the hex socket head cap screws on each side have been changed from 2 to 1.

*1: Due to the specification change, the slip torque value has been changed. → P.xxxx

● Part number specification

MJC-30CSK-ERD-10-11

Product Code Size Sleeve Type bore diameter

Please refer to dimensional table for part number specification.

- Additional Keyway at Shaft Hole → P.xxxx Available / Add'l charge
- Cleanroom Wash & Packaging → P.xxxx Available / Add'l charge
- Change to Stainless Steel Screw → P.xxxx Available / Add'l charge

● Applicable motors

	Tight Fit	Easy Fit
Servomotor	⊙	○
Stepping Motor	⊙	⊙
General-Purpose Motor	⊙	⊙

⊙: Excellent ○: Very good

● Property

	Tight Fit	Easy Fit
Zero Backlash	○	-
High Torque	⊙	⊙
Allowable Misalignment	○	○
Vibration Absorption	⊙	⊙
Electrical Insulation	⊙	⊙
Assembling	○	⊙
Allowable Operating Temperature	-20°C to 60°C	-20°C to 60°C

⊙: Excellent ○: Very good

● Sleeve Type

Sleeve Type	Sleeve Hardness (JIS)			
	A80	A92	A98	D64
Tight Fit				
Easy Fit				

Small ← Rated Torque / Max. Torque → Large
Large ← Allowable Misalignment → Small

● Tight Fit

The hub and sleeve are press-fit and can be used under zero backlash*1. Since the sleeve's vibration absorption can raise the gain of a servomotor, this unit can achieve high responsive operation exceeding the Disk coupling.

*1: For the torque used under zero backlash, please refer to dimensional table.

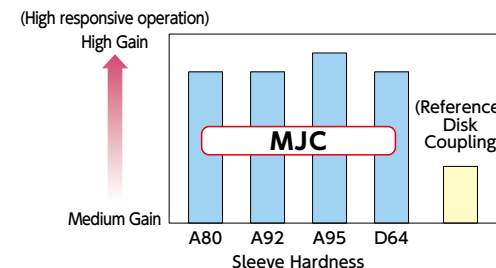

● Tight Fit Applications

XY stage / Index table / Machine tool / Injection molding machine



- This is a jaw type flexible coupling.
- Tight Fit enables transmission with zero backlash at low torque.
- Easy fit allows you to assemble and partition the hub and sleeve smoothly.
- Excellent flexibility allows eccentricity, angular misalignment and twisting vibration to be accepted.
- It has electrical insulation. Resistance value: Not less than 2 MΩ
- There are four types of sleeve hardness. Please select desirable units according to usage conditions including torque and misalignment.

● Easy Fit

This unit allows you to easily assemble and partition the hub and sleeve. This allows you to reduce the time of assembling the unit and maintenance. It is possible to mount a hub on the shaft in advance and easily assemble the unit even in a location where the coupling is less-visible.

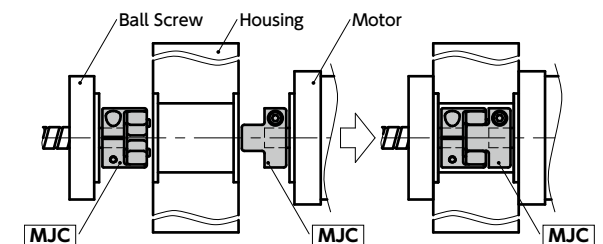

● Easy Fit Applications

Transport device / Mixer / Ventilator / Pump / Dispenser

Selection

● Selection based on shaft diameter and rated torque

The area bounded by the shaft diameter and rated torque indicates is the selection size.

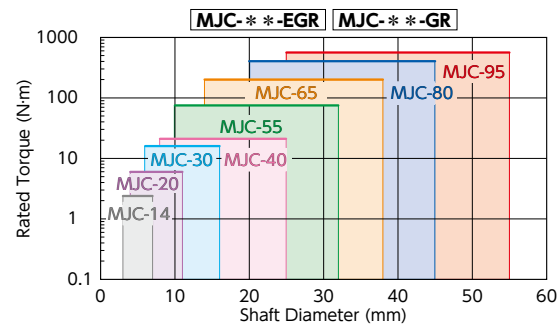
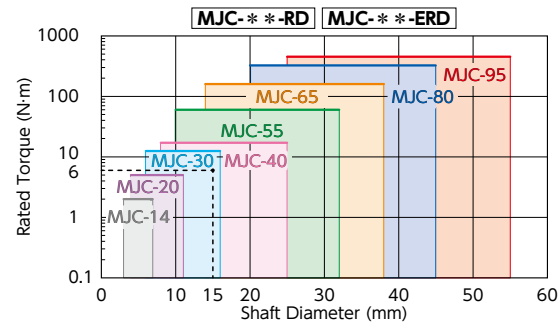
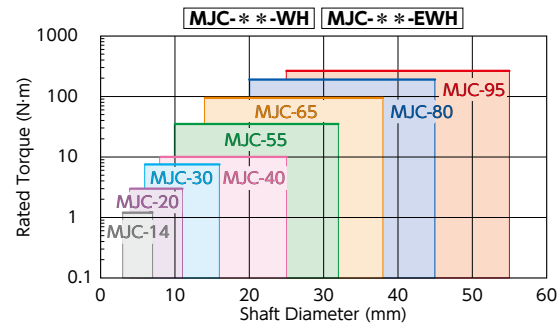
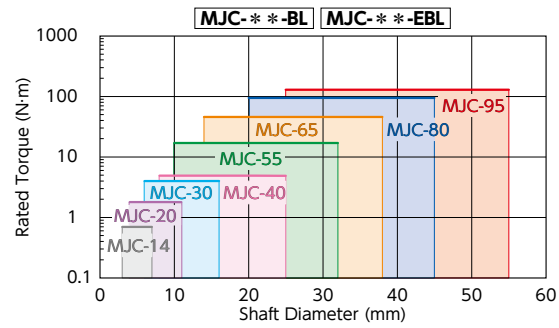

● Selection Example

In case of selected parameters of shaft diameter of $\phi 15$ and load torque of 6 N·m, the selected size for **MJC-**-RD**, **MJC-**-ERD** is **MJC-30-RD**, **MJC-30-ERD**.

● Selection based on the rated output of the servomotor

Rated Output (W)	Servomotor Specifications			Selection Outside Diameter Size			
	Diameter of Motor Shaft (mm)	Rated Torque (N·m)	Instantaneous Max. Torque (N·m)	MJC-**-BL MJC-**-EBL	MJC-**-WH MJC-**-EWH	MJC-**-RD MJC-**-ERD	MJC-**-GR MJC-**-EGR
10	5 - 6	0.032	0.096	14	14	14	14
20	5 - 6	0.064	0.19	14	14	14	14
30	5 - 7	0.096	0.29	14	14	14	14
50	6 - 8	0.16	0.48	20	20	20	20
100	8	0.32	0.95	20	20	20	20
200	9 - 14	0.64	1.9	30	30	30	30
400	14	1.3	3.8	30	30	30	30
750	16 - 19	2.4	7.2	-	40	40	40

● Motor specifications are based on general values. For details, see the motor manufacturer's catalogs. This is the size for cases where devices such as reduction gears are not used.

● Selection Example

In case of motor specification of shaft diameter of $\phi 9$ and rated torque of 0.64 N·m, the selected size of **MJC-**-BL** is as follows.

- Set Screw Type — **MJC-30-BL**
- Clamping Type — **MJC-30CS-BL**
- Set Screw + Key Type — **MJC-30K-BL**
- Clamping + Key Type — **MJC-30CSK-BL**

MJC Flexible coupling - Jaw - type - Set screw type

WEB Selection Tool | WEB CAD Download | High torque | Vibration absorption | Electrical Insulation

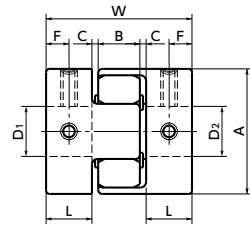

Outside Diameter: $\phi 14 - \phi 30$

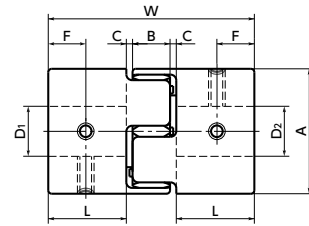
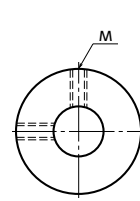

Outside Diameter: $\phi 40$

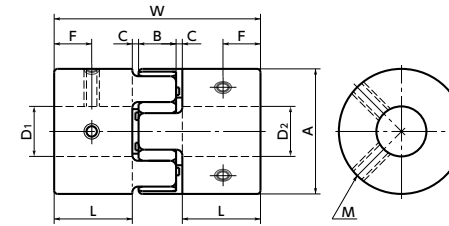
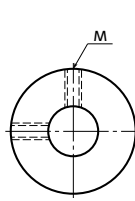

Outside Diameter: $\phi 55 - \phi 95$

Sleeve Details

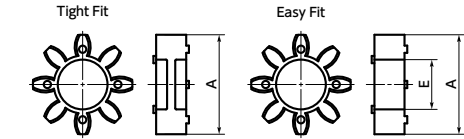

Ambient Temperature / Temperature Correction Factor

Ambient Temperature	Temperature Correction Factor
-20°C to 30°C	1.00
30°C to 40°C	0.80
40°C to 60°C	0.70

Dimensions

Unit : mm

Part Number	A	L	W	B	C*1	Sleeve E	F	M	Screw Tightening Torque (N·m)
MJC-14	14	7	22	6	1	4.5	3.5	M3	0.7
MJC-20	20	10	30	8	1	7	5	M3	0.7
MJC-30	30	11	35	10	1.5	11	5.5	M4	1.7
MJC-40	40	25	66	12	2	18	12.5	M5	4
MJC-55	55	30	78	14	2	27.5	15	M6	7
MJC-65	65	35	90	15	2.5	31	17.5	M8	15
MJC-80	80	45	114	18	3	37	22.5	M8	15
MJC-95	95	50	126	20	3	45.5	25	M8	15

*1: Use with C Dimension

Part Number	Standard metric bore diameter (dimensional allowance H8)																																		
	D1 · D2	3	4	4.5	5	6	6.35	7	8	9.525	10	11	12	14	15	16	18	19	20	22	24	25	28	30	32	35	38	40	42	45	48	50	55		
MJC-14	●	●	●	●	●	●	●	●																											
MJC-20		●	●	●	●	●	●	●	●	●	●	●	●	●	●	●	●	●	●	●	●	●	●	●	●	●	●	●	●	●	●	●	●	●	
MJC-30					●	●	●	●	●	●	●	●	●	●	●	●	●	●	●	●	●	●	●	●	●	●	●	●	●	●	●	●	●	●	
MJC-40								●	●	●	●	●	●	●	●	●	●	●	●	●	●	●	●	●	●	●	●	●	●	●	●	●	●	●	
MJC-55													●	●	●	●	●	●	●	●	●	●	●	●	●	●	●	●	●	●	●	●	●	●	
MJC-65																																			
MJC-80																																			
MJC-95																																			

Part Number	Standard inch bore diameter (dimensional allowance H7)																																			
	D1 · D2	1/8	3/16	1/4	5/16	3/8	7/16	1/2	9/16	5/8	11/16	3/4	13/16	7/8	15/16	1	1-1/8	1-1/4	1-3/8	1-1/2	1-5/8	1-3/4														
MJC-14	●	●	●	●	●	●	●	●	●	●	●	●	●	●	●	●	●	●	●	●	●	●	●	●	●	●	●	●	●	●	●	●	●	●		
MJC-20		●	●	●	●	●	●	●	●	●	●	●	●	●	●	●	●	●	●	●	●	●	●	●	●	●	●	●	●	●	●	●	●	●	●	
MJC-30				●	●	●	●	●	●	●	●	●	●	●	●	●	●	●	●	●	●	●	●	●	●	●	●	●	●	●	●	●	●	●	●	
MJC-40					●	●	●	●	●	●	●	●	●	●	●	●	●	●	●	●	●	●	●	●	●	●	●	●	●	●	●	●	●	●	●	
MJC-55						●	●	●	●	●	●	●	●	●	●	●	●	●	●	●	●	●	●	●	●	●	●	●	●	●	●	●	●	●	●	●
MJC-65									●	●	●	●	●	●	●	●	●	●	●	●	●	●	●	●	●	●	●	●	●	●	●	●	●	●	●	●
MJC-80																																				
MJC-95																																				

- All products are provided with hex socket set screw.
- In a case where the bore diameter are $\phi 3, \phi 4$ and $\phi 1/8$, the setscrew is used in only one place.
- Recommended dimensional allowances of applicable shaft diameter are h6 and h7.
- A set of hubs with set screw type for one side and clamping type or other type for the other side is available upon request.

Performance

Part Number	Sleeve		Max. Bore Diameter (mm)	Rated*1 torque (N·m)	Max.*1 torque (N·m)	Zero Backlash*3 Allowable Transmission Torque (N·m)	Max. Rotational Frequency (min ⁻¹)	Moment*2 of Inertia (kg·m ²)	Static Torsional Stiffness (N·m / rad)	Max. Lateral Misalignment (mm)	Max. Angular Misalignment (°)	Max. Axial Misalignment (mm)	Mass*2 (g)	Sleeve Hardness (JIS)
	Tight Fit	Easy Fit												
MJC-14	BL	EBL	7	0.7	1.4	0.1	45000	2.0 x 10 ⁻⁷	8	0.15	1	+0.6 0	6.6	A80
MJC-20	BL	EBL	11	1.8	3.6	0.2	31000	1.1 x 10 ⁻⁶	16	0.2	1	+0.8 0	17	
MJC-30	BL	EBL	16	4	8	0.5	21000	6.2 x 10 ⁻⁶	46	0.2	1	+1.0 0	44	
MJC-40	BL	EBL	25	4.9	9.8	1.2	15000	3.7 x 10 ⁻⁵	380	0.15	1	+1.2 0	130	
MJC-55	BL	EBL	32	17	34		11000	1.6 x 10 ⁻⁴	1400	0.2	1	+1.4 0	320	
MJC-65	BL	EBL	38.1	46	92		9000	3.6 x 10 ⁻⁴	2800	0.2	1	+1.5 0	520	
MJC-80	BL	EBL	45	95	190		7000	1.1 x 10 ⁻³	3200	0.2	1	+1.8 0	1000	
MJC-95	BL	EBL	55	130	260		6000	2.3 x 10 ⁻³	3600	0.2	1	+2.0 0	1500	
MJC-14	WH	EWH	7	1.2	2.4	0.1	45000	2.0 x 10 ⁻⁷	14	0.1	1	+0.6 0	6.6	
MJC-20	WH	EWH	11	3	6	0.2	31000	1.1 x 10 ⁻⁶	29	0.15	1	+0.8 0	17	
MJC-30	WH	EWH	16	7.5	15	0.5	21000	6.2 x 10 ⁻⁶	73	0.15	1	+1.0 0	44	
MJC-40	WH	EWH	25	10	20	1.2	15000	3.7 x 10 ⁻⁵	570	0.1	1	+1.2 0	130	
MJC-55	WH	EWH	32	35	70		11000	1.6 x 10 ⁻⁴	1600	0.15	1	+1.4 0	320	
MJC-65	WH	EWH	38.1	95	190		9000	3.6 x 10 ⁻⁴	3000	0.15	1	+1.5 0	520	
MJC-80	WH	EWH	45	190	380		7000	1.1 x 10 ⁻³	5300	0.15	1	+1.8 0	1000	
MJC-95	WH	EWH	55	265	530		6000	2.3 x 10 ⁻³	6200	0.15	1	+2.0 0	1500	
MJC-14	RD	ERD	7	2	4	0.1	45000	2.0 x 10 ⁻⁷	22	0.1	1	+0.6 0	6.6	A98
MJC-20	RD	ERD	11	5	10	0.2	31000	1.1 x 10 ⁻⁶	55	0.1	1	+0.8 0	17	
MJC-30	RD	ERD	16	12.5	25	0.5	21000	6.2 x 10 ⁻⁶	130	0.1	1	+1.0 0	44	
MJC-40	RD	ERD	25	17	34	1.2	15000	3.7 x 10 ⁻⁵	1200	0.1	1	+1.2 0	130	
MJC-55	RD	ERD	32	60	120		11000	1.6 x 10 ⁻⁴	2600	0.1	1	+1.4 0	320	
MJC-65	RD	ERD	38.1	160	320		9000	3.6 x 10 ⁻⁴	4900	0.1	1	+1.5 0	520	
MJC-80	RD	ERD	45	325	650		7000	1.1 x 10 ⁻³	6500	0.1	1	+1.8 0	1000	
MJC-95	RD	ERD	55	450	900		6000	2.3 x 10 ⁻³	8900	0.1	1	+2.0 0	1500	
MJC-14	GR	EGR	7	2.4	4.8	0.1	45000	2.0 x 10 ⁻⁷	66	0.08	1	+0.6 0	6.6	
MJC-20	GR	EGR	11	6	12	0.2	31000	1.1 x 10 ⁻⁶	87	0.08	1	+0.8 0	17	
MJC-30	GR	EGR	16	16	32	0.5	21000	6.2 x 10 ⁻⁶	200	0.08	1	+1.0 0	44	
MJC-40	GR	EGR	25	21	42	1.2	15000	3.7 x 10 ⁻⁵	3000	0.08	1	+1.2 0	130	
MJC-55	GR	EGR	32	75	150		11000	1.6 x 10 ⁻⁴	9000	0.08	1	+1.4 0	320	
MJC-65	GR	EGR	38.1	200	400		9000	3.6 x 10 ⁻⁴	13000	0.08	1	+1.5 0	520	
MJC-80	GR	EGR	45	405	810		7000	1.1 x 10 ⁻³	14000	0.08	1	+1.8 0	1000	
MJC-95	GR	EGR	55	560	1120		6000	2.3 x 10 ⁻³	15000	0.08	1	+2.0 0	1500	

- *1: Correction of rated torque and max. torque due to load fluctuation is not required. However, if ambient temperature exceeds 30°C, be sure to correct the rated torque and max. torque with temperature correction factor shown in the table. **MJC**'s allowable operating temperature is -20°C to 60°C.
- *2: These are values with max. bore diameter.
- *3: For transmission with Zero Backlash, please use a tight fit sleeve.

Part number specification

MJC-95-EBL-40-45



Additional Keyway at Shaft Hole → P.xxxx | Cleanroom Wash & Packaging → P.xxxx | Change to Stainless Steel Screw → P.xxxx
Available / Add'l charge | Available / Add'l charge | Available / Add'l charge

MJC-CS Flexible coupling - Jaw - type - Clamping type

Additional Size Revised Part number Specification Change

WEB Selection Tool WEB CAD Download High torque Vibration absorption Electrical Insulation

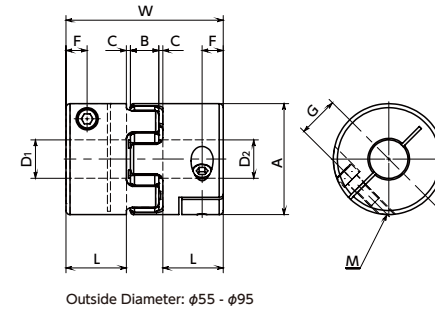
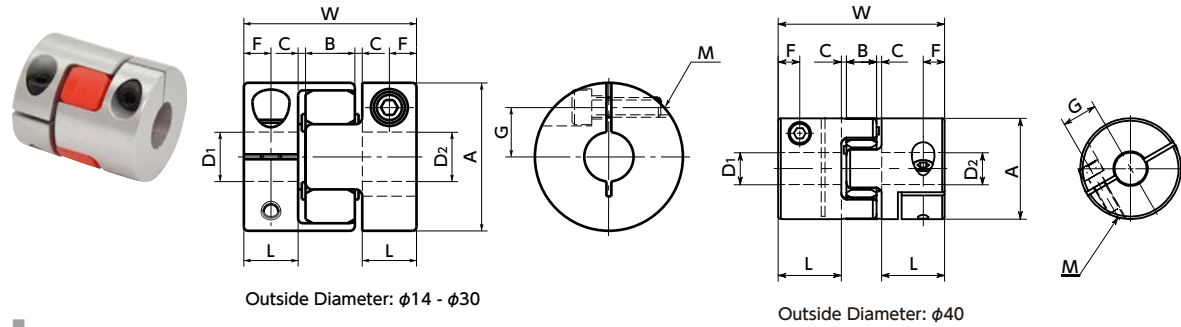

Sleeve Details

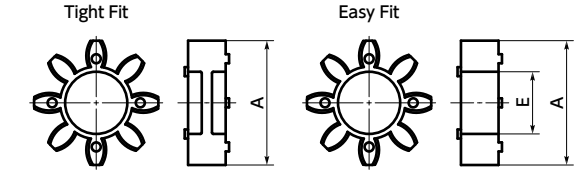

Ambient Temperature / Temperature Correction Factor

Ambient Temperature	Temperature Correction Factor
-20°C to 30°C	1.00
30°C to 40°C	0.80
40°C to 60°C	0.70

Dimensions

Unit : mm

Part Number	Bore Diameter	A	L	W	B	C*1	Sleeve E	F	G	M	Screw Tightening Torque (N·m)
MJC-14CS	3 - 5	14	7	22	6	1	4.5	3.5	4	M2	0.5
	6 - 7										
MJC-20CS	4 - 8	20	10	30	8	1	7	5	6.5	M2.5	1
	9.525 - 11										
MJC-30CS	6 - 12	30	11	35	10	1.5	11	5.5	10	M4	3.5
	12.7 - 16										
MJC-40CS	7.9375 - 20	40	25	66	12	2	18	8.5	14	M5	8
	22 - 25										
MJC-55CS	9.525 - 28	55	30	78	14	2	27.5	10.5	20	M6	13
	30 - 32										
MJC-65CS	12.7 - 32	65	35	90	15	2.5	31	13	24	M8	28
	34.925 - 38.1										
MJC-80CS	19.05 - 42	80	45	114	18	3	37	15	30	M8	28
	45										
MJC-95CS	0.05	95	50	126	20	3	45.5	18	34	M10	55
	50 - 55										

*1 : Use with C Dimension

Part Number	Standard metric bore diameter																																	
	D1	D2	3	4	4.5	5	6	6.35	7	8	9.525	10	11	12	14	15	16	18	19	20	22	24	25	28	30	32	35	38	40	42	45	48	50	55
MJC-14CS	●	●	●	●	●	●	●	●	●	●	●	●	●	●	●	●	●	●	●	●	●	●	●	●	●	●	●	●	●	●	●	●	●	●
MJC-20CS	●	●	●	●	●	●	●	●	●	●	●	●	●	●	●	●	●	●	●	●	●	●	●	●	●	●	●	●	●	●	●	●	●	●
MJC-30CS	●	●	●	●	●	●	●	●	●	●	●	●	●	●	●	●	●	●	●	●	●	●	●	●	●	●	●	●	●	●	●	●	●	●
MJC-40CS	●	●	●	●	●	●	●	●	●	●	●	●	●	●	●	●	●	●	●	●	●	●	●	●	●	●	●	●	●	●	●	●	●	●
MJC-55CS	●	●	●	●	●	●	●	●	●	●	●	●	●	●	●	●	●	●	●	●	●	●	●	●	●	●	●	●	●	●	●	●	●	●
MJC-65CS	●	●	●	●	●	●	●	●	●	●	●	●	●	●	●	●	●	●	●	●	●	●	●	●	●	●	●	●	●	●	●	●	●	●
MJC-80CS	●	●	●	●	●	●	●	●	●	●	●	●	●	●	●	●	●	●	●	●	●	●	●	●	●	●	●	●	●	●	●	●	●	●
MJC-95CS	●	●	●	●	●	●	●	●	●	●	●	●	●	●	●	●	●	●	●	●	●	●	●	●	●	●	●	●	●	●	●	●	●	●

Part Number	Standard inch bore diameter																							
	D1	D2	1/8	3/16	1/4	5/16	3/8	7/16	1/2	9/16	5/8	11/16	3/4	13/16	7/8	15/16	1	1 1/8	1 1/4	1 3/8	1 1/2	1 5/8	1 3/4	
MJC-14CS	●	●	●	●	●	●	●	●	●	●	●	●	●	●	●	●	●	●	●	●	●	●	●	●
MJC-20CS	●	●	●	●	●	●	●	●	●	●	●	●	●	●	●	●	●	●	●	●	●	●	●	●
MJC-30CS	●	●	●	●	●	●	●	●	●	●	●	●	●	●	●	●	●	●	●	●	●	●	●	●
MJC-40CS	●	●	●	●	●	●	●	●	●	●	●	●	●	●	●	●	●	●	●	●	●	●	●	●
MJC-55CS	●	●	●	●	●	●	●	●	●	●	●	●	●	●	●	●	●	●	●	●	●	●	●	●
MJC-65CS	●	●	●	●	●	●	●	●	●	●	●	●	●	●	●	●	●	●	●	●	●	●	●	●
MJC-80CS	●	●	●	●	●	●	●	●	●	●	●	●	●	●	●	●	●	●	●	●	●	●	●	●
MJC-95CS	●	●	●	●	●	●	●	●	●	●	●	●	●	●	●	●	●	●	●	●	●	●	●	●

- All products are provided with hex socket head cap screw.
- Recommended dimensional allowances of applicable shaft diameter are h6 and h7.
- A set of hubs with clamping type for one side and set screw type or other type for the other side is available upon request.
- In case of mounting on D-cut shaft, be careful about the position of the D-cut surface of the shaft. → P.xxxx

Performance

Part Number	Sleeve		Max. Bore Diameter (mm)	Rated ⁺¹ torque (N·m)	Max. ⁺¹ torque (N·m)	Zero Backlash ⁺³ Allowable Transmission Torque(N·m)	Max.Rotational Frequency (min ⁻¹)	Moment ⁺² of Inertia (kg·m ²)	Static Torsional Stiffness (N·m / rad)	Max. Lateral Misalignment (mm)	Max. Angular Misalignment (°)	Max. Axial Misalignment (mm)	Mass ⁺² (g)	Sleeve Hardness (JIS)	
	Tight Fit	Easy Fit													
MJC-14CS	BL	EBL	7	0.7	1.4	0.1	45000	1.9 x 10 ⁻⁷	8	0.15	1	+0.6 0	6.2	A80	
MJC-20CS	BL	EBL	11	1.8	3.6	0.2	31000	1.0 x 10 ⁻⁶	16	0.2	1	+0.8 0	16		
MJC-30CS	BL	EBL	16	4	8	0.5	21000	6.0 x 10 ⁻⁶	46	0.2	1	+1.0 0	42		
MJC-40CS	BL	EBL	25	4.9	9.8	1.2	15000	3.6 x 10 ⁻⁵	380	0.15	1	+1.2 0	130		
MJC-55CS	BL	EBL	32	17	34		11000	1.6 x 10 ⁻⁴	1400	0.2	1	+1.4 0	310		
MJC-65CS	BL	EBL	38.1	46	92		9000	3.5 x 10 ⁻⁴	2800	0.2	1	+1.5 0	500		
MJC-80CS	BL	EBL	45	95	190		7000	1.0 x 10 ⁻³	3200	0.2	1	+1.8 0	1000		
MJC-95CS	BL	EBL	55	130	260		6000	2.3 x 10 ⁻³	3600	0.2	1	+2.0 0	1600		
MJC-14CS	WH	EWH	7	1.2	2.4	0.1	45000	1.9 x 10 ⁻⁷	14	0.1	1	+0.6 0	6.2		A92
MJC-20CS	WH	EWH	11	3	6	0.2	31000	1.0 x 10 ⁻⁶	29	0.15	1	+0.8 0	16		
MJC-30CS	WH	EWH	16	7.5	15	0.5	21000	6.0 x 10 ⁻⁶	73	0.15	1	+1.0 0	42		
MJC-40CS	WH	EWH	25	10	20	1.2	15000	3.6 x 10 ⁻⁵	570	0.1	1	+1.2 0	130		
MJC-55CS	WH	EWH	32	35	70		11000	1.6 x 10 ⁻⁴	1600	0.15	1	+1.4 0	310		
MJC-65CS	WH	EWH	38.1	95	190		9000	3.5 x 10 ⁻⁴	3000	0.15	1	+1.5 0	500		
MJC-80CS	WH	EWH	45	190	380		7000	1.0 x 10 ⁻³	5300	0.15	1	+1.8 0	1000		
MJC-95CS	WH	EWH	55	265	530		6000	2.3 x 10 ⁻³	6200	0.15	1	+2.0 0	1600		
MJC-14CS	RD	ERD	7	2	4	0.1	45000	1.9 x 10 ⁻⁷	22	0.1	1	+0.6 0	6.2	A98	
MJC-20CS	RD	ERD	11	5	10	0.2	31000	1.0 x 10 ⁻⁶	55	0.1	1	+0.8 0	16		
MJC-30CS	RD	ERD	16	12.5	25	0.5	21000	6.0 x 10 ⁻⁶	130	0.1	1	+1.0 0	42		
MJC-40CS	RD	ERD	25	17	34	1.2	15000	3.6 x 10 ⁻⁵	1200	0.1	1	+1.2 0	130		
MJC-55CS	RD	ERD	32	60	120		11000	1.6 x 10 ⁻⁴	2600	0.1	1	+1.4 0	310		
MJC-65CS	RD	ERD	38.1	160	320		9000	3.5 x 10 ⁻⁴	4900	0.1	1	+1.5 0	500		
MJC-80CS	RD	ERD	45	325	650		7000	1.0 x 10 ⁻³	6500	0.1	1	+1.8 0	1000		
MJC-95CS	RD	ERD	55	450	900		6000	2.3 x 10 ⁻³	8900	0.1	1	+2.0 0	1600		
MJC-14CS	GR	EGR	7	2.4	4.8	0.1	45000	1.9 x 10 ⁻⁷	66	0.08	1	+0.6 0	6.2		D64
MJC-20CS	GR	EGR	11	6	12	0.2	31000	1.0 x 10 ⁻⁶	87	0.08	1	+0.8 0	16		
MJC-30CS	GR	EGR	16	16	32	0.5	21000	6.0 x 10 ⁻⁶	200	0.08	1	+1.0 0	42		
MJC-40CS	GR	EGR	25	21	42	1.2	15000	3.6 x 10 ⁻⁵	3000	0.08	1	+1.2 0	130		
MJC-55CS	GR	EGR	32	75	150		11000	1.6 x 10 ⁻⁴	9000	0.08	1	+1.4 0	310		
MJC-65CS	GR	EGR	38.1	200	400		9000	3.5 x 10 ⁻⁴	13000	0.08	1	+1.5 0	500		
MJC-80CS	GR	EGR	45	405	810		7000	1.0 x 10 ⁻³	14000	0.08	1	+1.8 0	1000		
MJC-95CS	GR	EGR	55	560	1120		6000	2.3 x 10 ⁻³	15000	0.08	1	+2.0 0	1600		

- *1 : Correction of rated torque and max. torque due to load fluctuation is not required. However, if ambient temperature exceeds 30°C, be sure to correct the rated torque and max. torque with temperature correction factor shown in the table. **MJC-CS**'s allowable operating temperature is -20°C to 60°C.
- *2 : These are values with max. bore diameter.
- *3 : For transmission with Zero Backlash, please use a tight fit sleeve.

Part number specification

MJC-30CS-GR-7-8

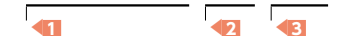

Additional Keyway at Shaft Hole → P.xxxx Cleanroom Wash & Packaging → P.xxxx Change to Stainless Steel Screw → P.xxxx Available / Add'l charge Available / Add'l charge Available / Add'l charge

