

## PNOZ XV2.1P C 3/24-240VACDC 2n/o 2n/o t

787542

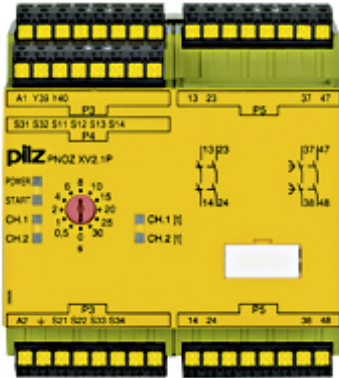

Safety relay (standalone) Inputs: 1-/2-channel wiring with/without detection of shorts across contacts Outputs: 2 N/O, 2 N/O (t = 0 - 3 s) . Automatic/monitored start UB 24 - 240 V AC/DC, width: 90 mm, plug-in spring-loaded terminals. Monitoring E-STOP, safety gates.

## Accessori opzionali



374291

PNOZ X Set spring loaded terminals P3+P4

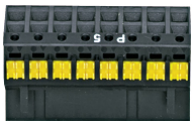

374292

PNOZ X Set spring loaded terminals P5+P5