



Principale

Gamma prodotto	Altivar 71
Tipo di prodotto o componente	Variatore di velocità
Prodotto per applicazioni specifiche	Macchine ad alta tensione, complesse
Nome componente	ATV71
Potenza motore in kW	0,37 kW a 200...240 V monofase 0,75 kW a 200...240 V 3 fasi
Potenza motore in hp	1 hp a 200...240 V 3 fasi 0,5 hp a 200...240 V monofase
Lunghezza cavo motore	
Tensione alimentazione nominale [Us]	200...240 V (- 15...10 %)
Numero di fasi della rete	3 fasi Monofase
Corrente di linea	5,3 A per 240 V 3 fasi 0,75 kW / 1 hp 5,8 A per 240 V monofase 0,37 kW / 0,5 hp 6,1 A per 200 V 3 fasi 0,75 kW / 1 hp 6,9 A per 200 V monofase 0,37 kW / 0,5 hp
Filtro EMC	Integrato
Stile assemblaggio	Con dissipatore di calore
Potenza apparente	1,4 kVA a 240 V monofase 0,37 kW / 0,5 hp 2,2 kVA a 240 V 3 fasi 0,75 kW / 1 hp
Isc linea prospettiva	<= 5 kA, 3 fasi <= 5 kA, monofase
Corrente di uscita nominale	3 A a 4 kHz 230 V monofase 0,37 kW / 0,5 hp 4,8 A a 4 kHz 230 V 3 fasi 0,75 kW / 1 hp
Corrente transitoria massima	4,5 A per 60 s monofase 0,37 kW / 0,5 hp 4,9 A per 2 s monofase 0,37 kW / 0,5 hp 7,2 A per 60 s 3 fasi 0,75 kW / 1 hp 7,9 A per 2 s 3 fasi 0,75 kW / 1 hp
Frequenza di uscita	0,1...599 Hz
Frequenza di commutazione nominale	4 kHz
Frequenza di commutazione	1...16 kHz regolabile 4...16 kHz con fattore di declassamento
Profilo di controllo motore asincrono	Sistema ENA (Energy adaptation) per carichi non equilibrati Controllo vettore di flusso (FVC) con sensore (vettore corrente) Controllo vettore di flusso senza sensore (SFVC) (vettore tensione o corrente) Rapporto tensione/frequenza (2 o 5 punti)
Tipo di polarizzazione	Nessuna impedenza per Modbus

Complementare

Applicazione prodotto	Motori asincroni Motori sincroni
Limiti tensione alimentazione	170...264 V
Frequenza di alimentazione	50...60 Hz (- 5...5 %)
Frequenza di rete	47,5...63 Hz
Gamma di velocità	1...100 per motore asincrono in modo circuito aperto, senza segnale di velocità 1...50 per motore sincrono in modo circuito aperto, senza segnale di velocità 1...1000 per motore asincrono in modo circuito chiuso con segnale encoder
Accuratezza velocità	+/-0,01% della velocità nominale per 0,2 Tn a Tn variazione coppia in modo circuito chiuso con segnale encoder +/-10% della velocità nominale per 0,2 Tn a Tn variazione coppia senza segnale velocità

Le informazioni fornite in questo documento contengono descrizioni generali e/o caratteristiche tecniche delle prestazioni dei prodotti in esso riportati. Questa documentazione non è da intendersi come esaustiva e non deve essere usata per determinare l'idoneità o l'affidabilità di questi prodotti per applicazioni specifiche dell'utente. È dovere di ogni utente o integratore eseguire la corretta e completa analisi dei rischi, valutazione e collaudo dei prodotti per quanto riguarda la specifica applicazione o uso. Né Schneider Electric S.p.A. né alcuna delle sue affiliate o consociate, possono essere ritenuti responsabili per l'uso improprio delle informazioni contenute nel presente documento.

Precisione di coppia	+/- 15 % in modo circuito aperto, senza segnale di velocità +/- 5 % in modo circuito chiuso con segnale encoder
Sovracoppia transitoria	220 % della coppia motore nominale +/- 10 % per 2 s 170 % della coppia motore nominale +/- 10 % per 60 s ogni 10 minuti
Coppia frenante	<= 150% con freno o resistore sollevamento 0.3 senza resistore freno
Profilo di controllo motore sincrono	Controllo vettoriale senza ritorno velocità
Circuito di regolazione	Regolatore PI regolabile
Compensazione slittamento motore	Regolabile Qualsiasi carico automatico Non disponibile nel rapporto tensione/frequenza (2 o 5 punti) Eliminabile
Segnalazione locale	1 LED rosso presenza di tensione unità
Tensione di uscita	<= tensione alimentatore
Isolamento	Elettrico tra alimentazione e controllo
Tipo di cavi	Con kit NEMA tipo 1 : 3-trefolo cavo UL 508 a 40 °C, rame 75°C PVC Con kit IP21 o IP31 : 3-trefolo cavo IEC a 40 °C, rame 70°C PVC Senza kit di montaggio : 1-trefolo cavo IEC a 45 °C, rame 70°C PVC Senza kit di montaggio : 1-trefolo cavo IEC a 45 °C, rame 90°C XLPE/EPR
Collegamento elettrico	AI1-/AI1+, AI2, AO1, R1A, R1B, R1C, R2A, R2B, LI1...LI6, PWR morsetto 2,5 mm ² / AWG 14 L1/R, L2/S, L3/T, U/T1, V/T2, W/T3, PC/-, PO, PA/+, PA, PB morsetto 4 mm ² / AWG 10
Coppia di serraggio	AI1-/AI1+, AI2, AO1, R1A, R1B, R1C, R2A, R2B, LI1...LI6, PWR 0,6 Nm L1/R, L2/S, L3/T, U/T1, V/T2, W/T3, PC/-, PO, PA/+, PA, PB 1,4 Nm / 12,3 lbin
Alimentazione	Alimentazione interna per potenziometro di riferimento (da 1 a 10 kOhm), 10,5 V DC +/- 5 %, <= 10 mA per protezione sovraccarico e da cortocircuito Alimentazione interna, 24 V DC, limiti tensione 21...27 V, <= 200 mA per protezione sovraccarico e da cortocircuito
Numero ingressi analogici	2
Tipo di ingresso analogico	AI1-/AI1+ tensione differenziale bipolare +/- 10 V CC, tensione ingresso 24 V max, risoluzione 11 bit + segno AI2 corrente configurabile con software 0...20 mA, impedenza 242 Ohm, risoluzione 11 bit AI2 tensione configurabile con software 0...10 V CC, tensione ingresso 24 V max, impedenza 30000 Ohm, risoluzione 11 bit
Durata campionatura	AI1-/AI1+ 2 ms, +/- 0,5 ms per analog ingressi AI2 2 ms, +/- 0,5 ms per analogico ingressi LI1...LI5 2 ms, +/- 0,5 ms per digitale ingressi LI6 (se configurato come ingresso logico) 2 ms, +/- 0,5 ms per digitale ingressi
Tempo di risposta	<= 100 ms in STO (Safe Torque Off) AO1 2 ms, tolleranza +/- 0,5 ms per analogico uscite R1A, R1B, R1C 7 ms, tolleranza +/- 0,5 ms per digitale uscite R2A, R2B 7 ms, tolleranza +/- 0,5 ms per digitale uscite
Precisione	AI1-/AI1+ +/-0,6% per una variazione di temperaturadi 60°C AI2 +/-0,6% per una variazione di temperaturadi 60°C AO1 +/- 1 % per una variazione di temperaturadi 60°C
Errore linearità	AI1-/AI1+, AI2 +/- 0,15% del valore massimo AO1 +/-0,2%
Numero uscite analogiche	1
Tipo uscita analogica	AO1 corrente configurabile con software 0...20 mA, impedenza 500 Ohm, risoluzione 10 bit AO1 uscita logica configurabile mediante software 10 V <= 20 mA AO1 tensione configurabile con software 0...10 V CC, impedenza 470 Ohm, risoluzione 10 bit
Numero uscite digitali	2
Tipo di uscita digitale	R1A, R1B, R1C logica relè configurabile NO/NC, durata elettrica 100000 cicli R2A, R2B logica relè configurabile NO, durata elettrica 100000 cicli
Corrente minima di commutazione	Logica relè configurabile 3 mA a 24 V CC
Massima corrente di commutazione	R1, R2 su resistivo carico, 5 A a 250 V CA, cos phi = 1, R1, R2 su resistivo carico, 5 A a 30 V CC, cos phi = 1, R1, R2 su induttivo carico, 2 A a 250 V CA, cos phi = 0,4, R1, R2 su induttivo carico, 2 A a 30 V CC, cos phi = 0,4,
Numero ingressi digitali	7
Tipo di ingresso digitale	LI6 : configurabile con interruttore 24 V CC con PLC livello 1, impedenza: 3500 Ohm PWR : ingresso di sicurezza 24 V CC, impedenza: 1500 Ohm conforme a ISO 13849-1 livello d LI1...LI5 : programmabile 24 V CC con PLC livello 1, impedenza: 3500 Ohm LI6 : sonda PTC configurabile con interruttore 0...6, impedenza: 1500 Ohm

Logica ingresso digitale	LI1...LI5 logica positiva (sorgente), < 5 V (stato 0), > 11 V (stato 0) LI1...LI5 logica negativa (corrente), > 16 V (stato 0), < 10 V (stato 0) LI6 (se configurato come ingresso logico) logica positiva (sorgente), < 5 V (stato 0), > 11 V (stato 0) LI6 (se configurato come ingresso logico) logica negativa (corrente), > 16 V (stato 0), < 10 V (stato 0)
Rampe accelerazione/decelerazione	Adattamento automatico rampa se oltre il potere d'interruzione, con resistore Regolabile linearmente e separatamente da 0,01 a 9000 s S, U o personalizzato
Frenatura di arresto	Con iniezione CC
Tipo di protezione	Comando contro superamento del limite di velocità Comando contro perdita fase ingresso Comando interruzione sul circuito di controllo Comando interruzione fase di ingresso Comando sovratensione alimentazione Comando sottotensione alimentazione Comando sovracorrente tra fasi uscita e messa a terra Comando protezione surriscaldamento Comando sovratensioni sul bus CC Comando cortocircuito tra le fasi del motore Comando protezione termica Motore interruzione fase motore Motore rimozione alimentazione Motore protezione termica
Resistenza di isolamento	> 1 mOhm a 500 V CC per 1 minuto a massa
Risoluzione frequenza	Ingresso analogico 0,024/50 Hz Unità display 0,1 Hz
Compatibilità	CANopen Modbus
Tipo di connettore	1 RJ45 per Modbus su lato anteriore 1 RJ45 per Modbus sul morsetto SUB-D 9 maschio su RJ45 per CANopen
Interfaccia fisica	2 cavi RS 485 per Modbus
Trama di trasmissione	RTU per Modbus
Velocità di trasmissione	20 kbps, 50 kbps, 125 kbps, 250 kbps, 500 kbps, 1 Mbps per CANopen 4800 bps, 9600 bps, 19200 bps, 38,4 Kbps per Modbus sul morsetto 9600 bps, 19200 bps per Modbus su lato anteriore
Formato dati	8 bit, 1 arresto, parità pari per Modbus su lato anteriore 8 bit, parità dispari o nessuna parità configurabile per Modbus sul morsetto
Numero di indirizzi	1...247 per Modbus 1...127 per CANopen
Metodo di accesso	Slave per CANopen
Simbologia	CE
Posizione di funzionamento	Verticale +/- 10 gradi
Altezza	230 mm
Profondità	175 mm
Larghezza	130 mm
Peso prodotto	3 kg
Funzionalità	Pieno
Applicazione specifica	Altre applicazioni
Scheda opzioni	CC-Link scheda comunicazione Scheda programmabile interna controller DeviceNet scheda comunicazione Ethernet/IP scheda comunicazione Fipio scheda comunicazione I/O extension card Interbus-S scheda comunicazione Scheda di interfaccia per encoder Modbus Plus scheda comunicazione Modbus TCP scheda comunicazione Modbus/Uni-Telway scheda comunicazione Scheda carro ponte Profibus DP scheda comunicazione Profibus DP V1 scheda comunicazione

Ambiente

livello di rumore	43 dB conforme a 86/188/EEC
-------------------	-----------------------------

resistenza dielettrica	2830 V DC tra terminali di terra e alimentazione 4230 V DC tra terminali di controllo e alimentazione
compatibilità elettromagnetica	Test immunità radiofrequenza condotta conforme a IEC 61000-4-6 livello 3 Prova di immunità ai transitori veloci / burst conforme a IEC 61000-4-4 livello 4 Test immunità scarica elettrostatica conforme a IEC 61000-4-2 livello 3 Test immunità ai campi elettromagnetici irradiati a radiofrequenza conforme a IEC 61000-4-3 livello 3 Test immunità cali di tensione e interruzioni conforme a IEC 61000-4-11 Prova di immunità all'impulso di tensione-corrente 1,2/50 µs - 8/20 µs conforme a IEC 61000-4-5 livello 3
norme di riferimento	EN 55011 classe A gruppo 1 EN 61800-3 ambienti 1 categoria C2 EN 61800-3 ambienti 2 categoria C2 EN/IEC 61800-3 EN/IEC 61800-5-1 IEC 60721-3-3 gruppo 3C1 IEC 60721-3-3 gruppo 3S2 UL tipo 1
certificazioni prodotto	CSA C-Tick GOST NOM 117 UL
grado di inquinamento	2 conforme a EN/IEC 61800-5-1
grado di protezione IP	IP20
resistenza alle vibrazioni	1,5 mm picco-picco (F = 3...13 Hz) conforme a EN/IEC 60068-2-6 1 gn (F = 13...200 Hz) conforme a EN/IEC 60068-2-6
resistenza agli shock	15 gn per 11 ms conforme a EN/IEC 60068-2-27
umidità relativa	5...95% senza condensa conforme a IEC 60068-2-3 5...95% senza caduta verticale di gocce d'acqua conforme a IEC 60068-2-3
temperatura ambiente di funzionamento	-10...50°C senza riduzione
temperatura di stoccaggio	-25...70°C
altitudine di funzionamento	<= 1000 m senza riduzione 1000...3000 m con declassamento corrente dell'1% per 100 m

UL Type 1/IP 20 Drives

Dimensions without Option Card

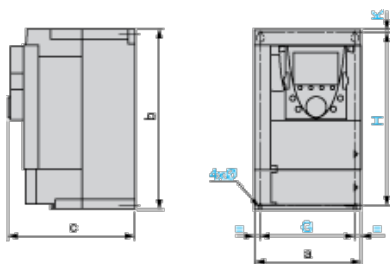

Dimensions in mm

a	b	c	G	H	K	Ø
130	230	175	113.5	220	5	5

Dimensions in in.

a	b	c	G	H	K	Ø
5.11	9.05	6.89	4.46	8.66	0.19	0.19

Dimensions with 1 Option Card (1)

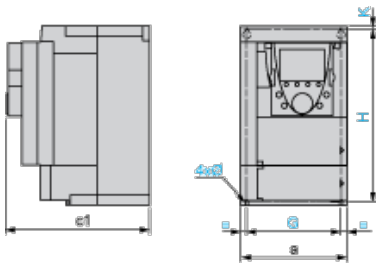

Dimensions in mm

a	c1	G	H	K	Ø
130	198	113.5	220	5	5

Dimensions in in.

a	c1	G	H	K	Ø
5.11	7.79	4.46	8.66	0.19	0.19

(1) Option cards: I/O extension cards, communication cards or "Controller Inside" programmable card.

Dimensions with 2 Option Cards (1)

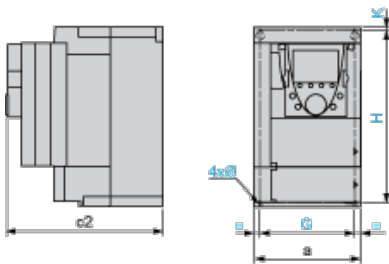

Dimensions in mm

a	c2	G	H	K	Ø
130	221	113.5	220	5	5

Dimensions in in.

a	c2	G	H	K	Ø
5.11	8.70	4.46	8.66	0.19	0.19

(1) Option cards: I/O extension cards, communication cards or "Controller Inside" programmable card.

Mounting Recommendations

Depending on the conditions in which the drive is to be used, its installation will require certain precautions and the use of appropriate accessories.

Install the unit vertically:

- ▮ Avoid placing it close to heating elements
- ▮ Leave sufficient free space to ensure that the air required for cooling purposes can circulate from the bottom to the top of the unit.

Clearance

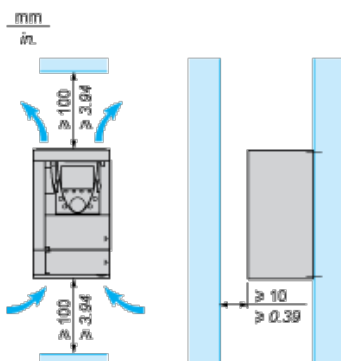

Mounting Types

Type A Mounting

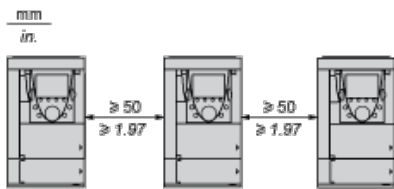

Type B Mounting

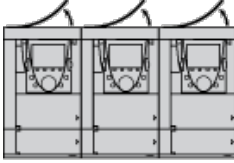

Type C Mounting

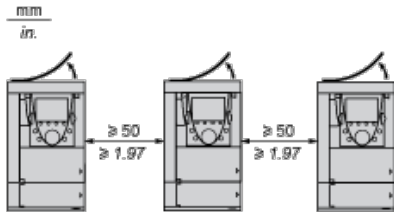

By removing the protective blanking cover from the top of the drive, the degree of protection for the drive becomes IP 20.

The protective blanking cover may vary according to the drive model (refer to the user guide).

The protective blanking cover must be removed from ATV 71P••N4Z drives when they are mounted in a dust and damp proof enclosure.

Specific Recommendations for Mounting the Drive in an Enclosure

Ventilation

To ensure proper air circulation in the drive:

- 1 Fit ventilation grilles.
- 1 Ensure that there is sufficient ventilation. If there is not, install a forced ventilation unit with a filter. The openings and/or fans must provide a flow rate at least equal to that of the drive fans (refer to the product characteristics).

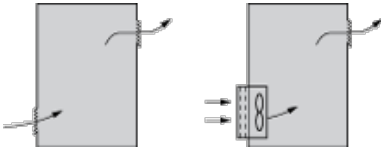

- 1 Use special filters with IP 54 protection.
- 1 Remove the blanking cover from the top of the drive.

Dust and Damp Proof Metal Enclosure (IP 54)

The drive must be mounted in a dust and damp proof enclosure in certain environmental conditions: dust, corrosive gases, high humidity with risk of condensation and dripping water, splashing liquid, etc.

This enables the drive to be used in an enclosure where the maximum internal temperature reaches 50°C.

Wiring Diagram Conforming to Standards EN 954-1 Category 1, IEC/EN 61508 Capacity SIL1, in Stopping Category 0 According to IEC/EN 60204-1

Three-Phase Power Supply with Upstream Breaking via Contactor

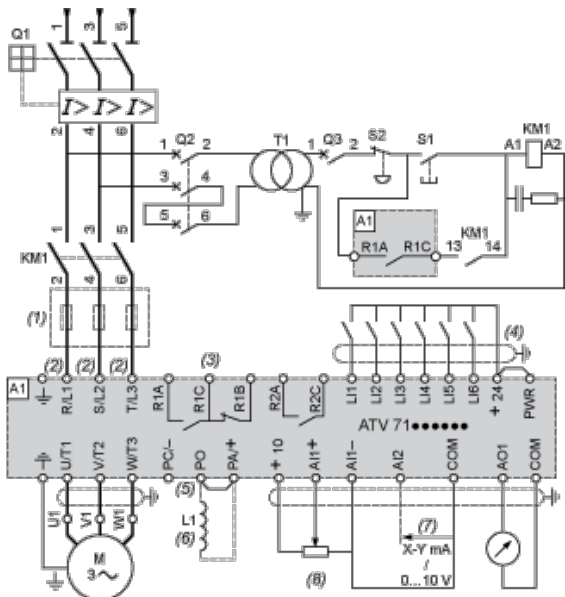

A1 ATV71 drive

KM1 Contactor

L1 DC choke

Q1 Circuit-breaker

Q2 GV2 L rated at twice the nominal primary current of T1

Q3 GB2CB05

S1, XB4 B or XB5 A pushbuttons

S2

T1 100 VA transformer 220 V secondary

(1) Line choke (three-phase); mandatory for ATV71HC11Y...HC63Y drives (except when a special transformer is used (12-pulse)).

(2) For ATV71HC40N4 drives combined with a 400 kW motor, ATV71HC50N4 and ATV71HC40Y...HC63Y, refer to the power terminal connections diagram.

(3) Fault relay contacts. Used for remote signalling of the drive status.

(4) Connection of the common for the logic inputs depends on the positioning of the SW1 switch. The above diagram shows the internal power supply switched to the "source" position (for other connection types, refer to the user guide).

(5) There is no PO terminal on ATV71HC11Y...HC63Y drives.

(6) Optional DC choke for ATV71H...M3, ATV71HD11M3X...HD45M3X, ATV71•075N4...•D75N4 and ATV71P...N4Z drives. Connected in place of the strap between the PO and PA+ terminals. For ATV71HD55M3X, HD75M3X, ATV71HD90N4...HC50N4 drives, the choke is supplied with the drive; the customer is responsible for connecting it.

(7) Software-configurable current (0...20 mA) or voltage (0...10 V) analog input.

(8) Reference potentiometer.

All terminals are located at the bottom of the drive. Fit interference suppressors on all inductive circuits near the drive or connected on the same circuit, such as relays, contactors, solenoid valves, fluorescent lighting, etc.

Wiring Diagram Conforming to Standards EN 954-1 Category 1, IEC/EN 61508 Capacity SIL1, in Stopping Category 0 According to IEC/EN 60204-1

Power Section for Single-Phase Power Supply

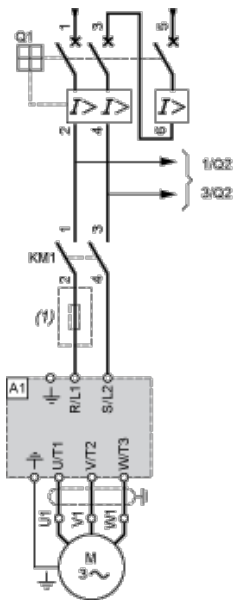

A1 ATV71 drive

KM1 Contactor

Q1 Circuit-breaker

Q2 GV2 L rated at twice the nominal primary current of T1

(1) Line Choke (single-phase); mandatory for ATV71HU40M3...HU75M3 drives with a 200...240 V 50/60 Hz single-phase power supply.

All terminals are located at the bottom of the drive. Fit interference suppressors on all inductive circuits near the drive or connected on the same circuit, such as relays, contactors, solenoid valves, fluorescent lighting, etc.

Wiring Diagram Conforming to Standards EN 954-1 Category 1, IEC/EN 61508 Capacity SIL1, in Stopping Category 0 According to IEC/EN 60204-1

Three-Phase Power Supply with Downstream Breaking via Switch Disconnector

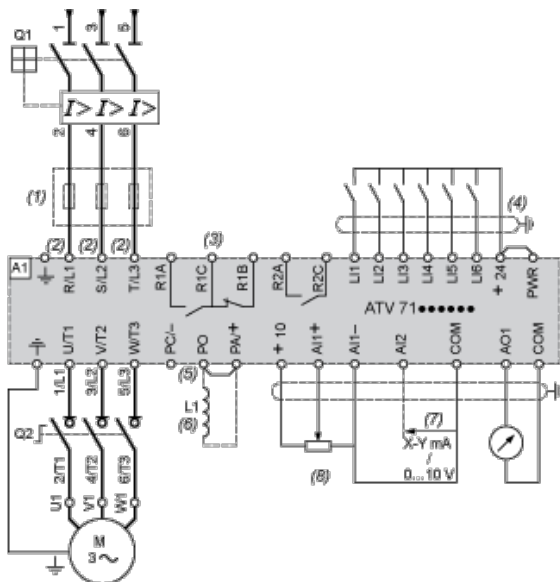

A1 ATV71 drive

L1 DC choke

Q1 Circuit-breaker

Q2 Switch disconnector (Vario)

(1) Line choke (three-phase), mandatory for ATV71HC11Y...HC63Y drives (except when a special transformer is used (12-pulse)).

(2) For ATV71HC40N4 drives combined with a 400 kW motor, ATV71HC50N4 and ATV71HC40Y...HC63Y, refer to the power terminal connections diagram.

(3) Fault relay contacts. Used for remote signalling of the drive status.

(4) Connection of the common for the logic inputs depends on the positioning of the SW1 switch. The above diagram shows the internal power supply switched to the "source" position (for other connection types, refer to the user guide).

(5) There is no PO terminal on ATV71HC11Y...HC63Y drives.

(6) Optional DC choke for ATV71H...M3, ATV71HD11M3X...HD45M3X, ATV71•075N4...•D75N4 and ATV71P...N4Z drives.

Connected in place of the strap between the PO and PA/+ terminals. For ATV71HD55M3X, HD75M3X, ATV71HD90N4...HC50N4 drives, the choke is supplied with the drive; the customer is responsible for connecting it.

- (7) Software-configurable current (0...20 mA) or voltage (0...10 V) analog input.
- (8) Reference potentiometer.

All terminals are located at the bottom of the drive. Fit interference suppressors on all inductive circuits near the drive or connected on the same circuit, such as relays, contactors, solenoid valves, fluorescent lighting, etc.

Wiring Diagram Conforming to Standards EN 954-1 Category 1, IEC/EN 61508 Capacity SIL1, in Stopping Category 0 According to IEC/EN 60204-1

Power Section for Single-Phase Power Supply

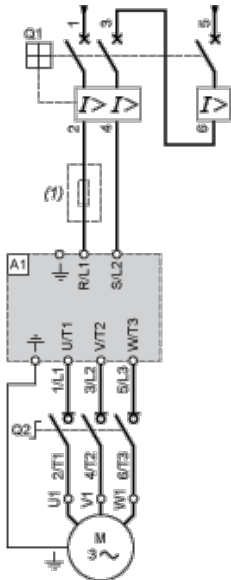

A1 ATV71 drive

Q1 Circuit-breaker

Q2 Switch disconnecter (Vario)

(1) Line Choke (single-phase); mandatory for ATV71HU40M3...HU75M3 drives with a 200...240 V 50/60 Hz single-phase power supply.

All terminals are located at the bottom of the drive. Fit interference suppressors on all inductive circuits near the drive or connected on the same circuit, such as relays, contactors, solenoid valves, fluorescent lighting, etc.

Wiring Diagram Conforming to Standards EN 954-1 Category 3, IEC/EN 61508 Capacity SIL2, in Stopping Category 0 According to IEC/EN 60204-1

Three-Phase Power Supply, Low Inertia Machine, Vertical Movement

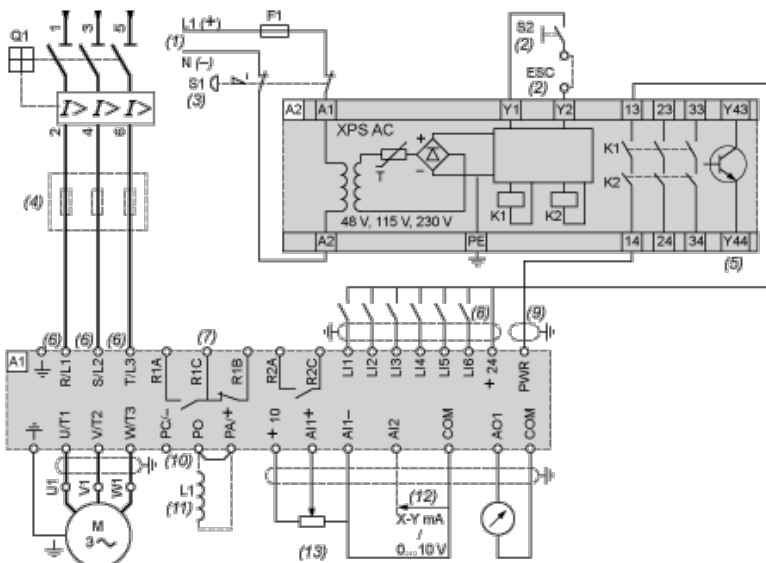

A1 ATV71 drive

A2 Preventa XPS AC safety module for monitoring emergency stops and switches. One safety module can manage the "Power Removal" function for several drives on the same machine. In this case, each drive must connect its PWR terminal to its + 24 V via

the safety contacts on the XPS AC module. These contacts are independent for each drive.

- F1 Fuse
 - L1 DC choke
 - Q1 Circuit-breaker
 - S1 Emergency stop button with 2 contacts
 - S2 XB4 B or XB5 A pushbutton
- (1) Power supply: 24 Vdc or Vac, 48 Vac, 115 Vac, 230 Vac.
 - (2) S2: resets XPS AC module on power-up or after an emergency stop. ESC can be used to set external starting conditions.
 - (3) Requests freewheel stopping of the movement and activates the "Power Removal" safety function.
 - (4) Line choke (three-phase), mandatory for and ATV71HC11Y...HC63Y drives (except when a special transformer is used (12-pulse)).
 - (5) The logic output can be used to signal that the machine is in a safe stop state.
 - (6) For ATV71HC40N4 drives combined with a 400 kW motor, ATV71HC50N4 and ATV71HC40Y...HC63Y, refer to the power terminal connections diagram.
 - (7) Fault relay contacts. Used for remote signalling of the drive status.
 - (8) Connection of the common for the logic inputs depends on the positioning of the SW1 switch. The above diagram shows the internal power supply switched to the "source" position (for other connection types, refer to the user guide).
 - (9) Standardized coaxial cable, type RG174/U according to MIL-C17 or KX3B according to NF C 93-550, external diameter 2.54 mm / 0.09 in., maximum length 15 m / 49.21 ft. The cable shielding must be earthed.
 - (10) There is no PO terminal on ATV71HC11Y...HC63Y drives.
 - (11) Optional DC choke for ATV71H...M3, ATV71HD11M3X...HD45M3X, ATV71•075N4...•D75N4 and ATV71P...N4Z drives. Connected in place of the strap between the PO and PA/+ terminals. For ATV71HD55M3X, HD75M3X, ATV71HD90N4...HC50N4 drives, the choke is supplied with the drive; the customer is responsible for connecting it.
 - (12) Software-configurable current (0...20 mA) or voltage (0...10 V) analog input.
 - (13) Reference potentiometer.

All terminals are located at the bottom of the drive. Fit interference suppressors on all inductive circuits near the drive or connected on the same circuit, such as relays, contactors, solenoid valves, fluorescent lighting, etc.

Wiring Diagram Conforming to Standards EN 954-1 Category 3, IEC/EN 61508 Capacity SIL2, in Stopping Category 0 According to IEC/EN 60204-1

Power Section for Single-Phase Power Supply

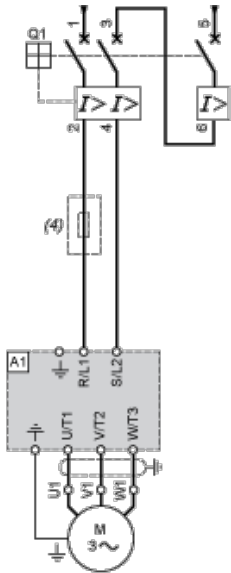

- A1 ATV71 drive
 - Q1 Circuit-breaker
- (4) Line Choke (single-phase); mandatory for ATV71HU40M3...HU75M3 drives with a 200...240 V 50/60 Hz single-phase power supply.

All terminals are located at the bottom of the drive. Fit interference suppressors on all inductive circuits near the drive or connected on the same circuit, such as relays, contactors, solenoid valves, fluorescent lighting, etc.

Wiring Diagram Conforming to Standards EN 954-1 Category 3, IEC/EN 61508 Capacity SIL2, in Stopping Category 1 According to IEC/EN 60204-1

Three-Phase Power Supply, High Inertia Machine

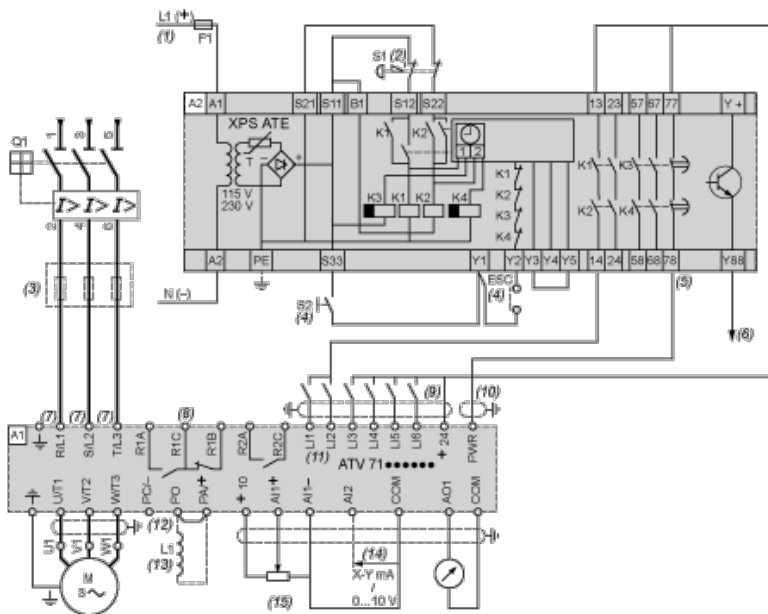

- A1 ATV71 drive
- A2 Preventa XPS ATE safety module for monitoring emergency stops and switches. One safety module can manage the "Power Removal" safety function for several drives on the same machine. In this case the time delay must be adjusted on the drive controlling the motor that requires the longest stopping time. In addition, each drive must connect its PWR terminal to its + 24 V via the safety contacts on the XPS ATE module. These contacts are independent for each drive.
- (5) Removal" safety function for several drives on the same machine. In this case the time delay must be adjusted on the drive controlling the motor that requires the longest stopping time. In addition, each drive must connect its PWR terminal to its + 24 V via the safety contacts on the XPS ATE module. These contacts are independent for each drive.
- F1 Fuse
- L1 DC choke
- Q1 Circuit-breaker
- S1 Emergency stop button with 2 N/C contacts
- S2 Run button
- (1) Power supply: 24 Vdc or Vac, 115 Vac, 230 Vac.
- (2) Requests controlled stopping of the movement and activates the "Power Removal" safety function.
- (3) Line choke (three-phase), mandatory for ATV71HC11Y...HC63Y drives (except when a special transformer is used (12-pulse)).
- (4) S2: resets XPS ATE module on power-up or after an emergency stop. ESC can be used to set external starting conditions.
- (5) For stopping times requiring more than 30 seconds in category 1, use a Preventa XPS AV safety module which can provide a maximum time delay of 300 seconds.
- (6) The logic output can be used to signal that the machine is in a safe state.
- (7) For ATV71HC40N4 drives combined with a 400 kW motor, ATV71HC50N4 and ATV71HC40Y...HC63Y, refer to the power terminal connections diagram.
- (8) Fault relay contacts. Used for remote signalling of the drive status.
- (9) Connection of the common for the logic inputs depends on the positioning of the SW1 switch. The above diagram shows the internal power supply switched to the "source" position (for other connection types, refer to the user guide).
- (10) Standardized coaxial cable, type RG174/U according to MIL-C17 or KX3B according to NF C 93-550, external diameter 2.54 mm/0.09 in., maximum length 15 m/49.21 ft. The cable shielding must be earthed.
- (11) Logic inputs LI1 and LI2 must be assigned to the direction of rotation: LI1 in the forward direction and LI2 in the reverse direction.
- (12) There is no PO terminal on ATV71HC11Y...HC63Y drives.
- (13) Optional DC choke for ATV71H...M3, ATV71HD11M3X...HD45M3X, ATV71•075N4...•D75N4 and ATV71P...N4Z drives. Connected in place of the strap between the PO and PA/+ terminals. For ATV71HD55M3X, HD75M3X, ATV71HD90N4...HC50N4 drives, the choke is supplied with the drive; the customer is responsible for connecting it.
- (14) Software-configurable current (0...20 mA) or voltage (0...10 V) analog input.
- (15) Reference potentiometer.

All terminals are located at the bottom of the drive. Fit interference suppressors on all inductive circuits near the drive or connected on the same circuit, such as relays, contactors, solenoid valves, fluorescent lighting, etc.

Wiring Diagram Conforming to Standards EN 954-1 Category 3, IEC/EN 61508 Capacity SIL2, in Stopping Category 1 According to IEC/EN 60204-1

Power Section for Single-Phase Power Supply

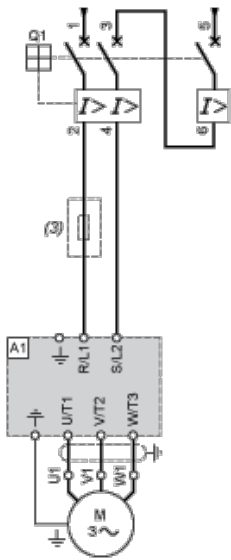

A1 ATV71 drive

Q1 Circuit-breaker

(3) Line Choke (single-phase); mandatory for ATV71HU40M3...HU75M3 drives with a 200...240 V 50/60 Hz single-phase power supply.

All terminals are located at the bottom of the drive. Fit interference suppressors on all inductive circuits near the drive or connected on the same circuit, such as relays, contactors, solenoid valves, fluorescent lighting, etc.

Derating Curves

The derating curves for the drive nominal current (I_n) depend on the temperature, the switching frequency and the mounting type. For intermediate temperatures (e.g. 55°C), interpolate between 2 curves.

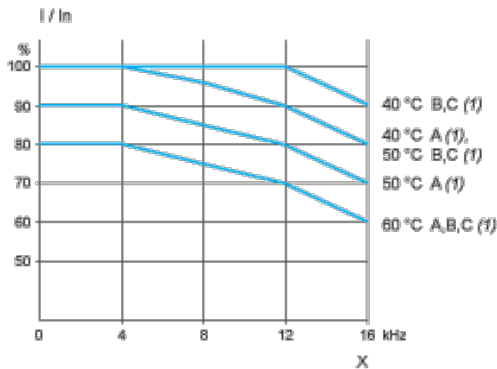

X Switching frequency

(f) Mounting type