

GV2L10

Interruttore automatico GV2L - 32 A - 3 poli 3d -
sganciatore magnetico



Principale

Gamma	TeSys
Nome del prodotto	TeSys GV2
Nome abbreviato	GV2L
Applicazione	Motore
Numero di poli	3P
Tipo di rete	CA
Categoria di utilizzo	AC-3 conforme a IEC 60947-4-1 Categoria A conforme a IEC 60947-2
Frequenza di rete	50/60 Hz conforme a IEC 60947-2
Potere di interruzione	100 kA Icu a 500 V CA 50/60 Hz conforme a IEC 60947-2 100 kA Icu a 230/240 V CA 50/60 Hz conforme a IEC 60947-2 100 kA Icu a 400/415 V CA 50/60 Hz conforme a IEC 60947-2 100 kA Icu a 440 V CA 50/60 Hz conforme a IEC 60947-2 4 kA Icu a 690 V CA 50/60 Hz conforme a IEC 60947-2
Potere di interruzione di servizio nominale [Ics]	100 % a 230/240 V CA 50/60 Hz conforme a IEC 60947-2 100 % a 440 V CA 50/60 Hz conforme a IEC 60947-2 100 % a 500 V CA 50/60 Hz conforme a IEC 60947-2 100 % a 690 V CA 50/60 Hz conforme a IEC 60947-2 100 % a 400/415 V CA 50/60 Hz conforme a IEC 60947-2
Tecnologia sganciatore	Magnetico
Corrente di sgancio magnetico	78 A

Complementare

Tipo di fissaggio	Agganciato su guida DIN simmetrica 35 mm Screwed on panel (with 2 x M4 screws)
Posizione di funzionamento	Qualunque posizione
Potenza motore in kW	3 kW a 500 V CA 50/60 Hz 4 kW a 690 V CA 50/60 Hz 2,2 kW a 400/415 V CA 50/60 Hz
Tipo di comando	Manovra rotativa
Tensione nominale di impiego [Ue]	690 V CA 50/60 Hz conforme a IEC 60947-2
Tensione nominale di isolamento [Ui]	690 V CA 50/60 Hz conforme a IEC 60947-2
Tensione nominale di tenuta ad impulso [Uimp]	6 kV conforme a IEC 60947-2
Dissipazione energia per polo	1,8 W
Durata meccanica	100000 cicli
Durata elettrica	100000 cicli per AC-3 a 415 V
Massima velocità operativa	40 cicli/h
Servizio nominale	Continuo conforme a IEC 60947-4-1
Connessioni - morsetti	Morsetti di fissaggio a vite 2 cavi 1...6 mm ² solido Morsetti di fissaggio a vite 2 cavi 1,5...6 mm ² flessibile senza estremità cavo Morsetti di fissaggio a vite 2 cavi 1...4 mm ² flessibile con estremità cavo
Coppia di serraggio	1,7 Nm su morsetti di fissaggio a vite
Robustezza meccanica	Urti 30 Gn conforme a IEC 60068-2-27

Le informazioni fornite in questo documento contengono descrizioni generali e/o caratteristiche tecniche delle prestazioni dei prodotti in esso riportati. Questa documentazione non è da intendersi come esaustiva e non deve essere usata per determinare l'idoneità o l'affidabilità di questi prodotti per applicazioni specifiche dell'utente. È dovere di ogni utente o integratore eseguire la corretta e completa analisi dei rischi, valutazione e collaudo dei prodotti per quanto riguarda la specifica applicazione o uso. Né Schneider Electric S.p.A. né alcuna delle sue affiliate o consociate, possono essere ritenuti responsabili per l'uso improprio delle informazioni contenute nel presente documento.

Attitudine al sezionamento	Si conforme a IEC 60947-1
Sensibilità mancanza di fase	S'
Altezza	89 mm
Larghezza	45 mm
Profondità	97 mm
Peso prodotto	0,33 kg

Ambiente

norme di riferimento	EN 60204 IEC 60947-1 IEC 60947-2 NF C 63-120 NF C 63-650 NF C 79-130 VDE 0113 VDE 0660
certificazioni prodotto	BV CCC CSA DNV GL LRQS (Lloyds register of shipping) RINA
trattamento di protezione	TH
grado di protezione IK	IK04
temperatura ambiente di funzionamento	-20...60°C
temperatura di stoccaggio	-40...80°C
resistenza al fuoco	960 °C conforme a IEC 60695-2-1
altitudine di funzionamento	0...2000 m

Sostenibilità dell'offerta

Stato sostenibilità offerta	Prodotto Green Premium
RoHS (codice data: aass)	Conforme - da 0631 - dichiarazione di conformità Schneider Electric
REACH	Contiene SVHC oltre i limiti
Profilo ambientale prodotto	Disponibile
Istruzioni fine vita prodotto	Non richiede operazioni specifiche di riciclaggio

Tripping Curves for GV2L or LE Combined with Thermal Overload Relay LRD or LR2K

Average Operating Times at 20 °C Related to Multiples of the Setting Current



- 1 3 poles from cold state
- 2 2 poles from cold state
- 3 3 poles from hot state

Current Limitation on Short-Circuit for GV2L and GV2LE Only (3-Phase 400/415 V)

Dynamic Stress

$I_{peak} = f(\text{prospective } I_{sc}) \text{ at } 1.05 U_e = 435 \text{ V}$

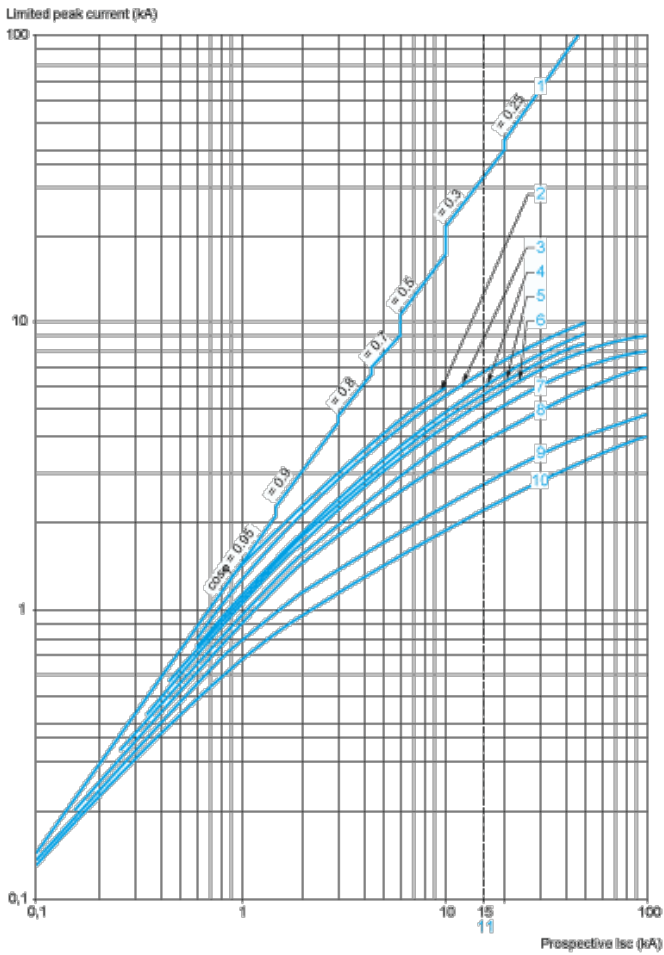

- 1 Maximum peak current
- 2 32 A
- 3 25 A
- 4 18 A
- 5 14 A
- 6 10 A
- 7 6.3 A
- 8 4 A
- 9 2.5 A
- 10 1.6 A
- 11 Limit of rated ultimate breaking capacity on short-circuit of GV2LE (14, 18, 23, and 25 A ratings).

Current Limitation on Short-Circuit for GV2L and GV2LE + Thermal Overload Relay LRD or LR2K (3-Phase 400/415 V)

Dynamic Stress

$I_{peak} = f(\text{prospective } I_{sc}) \text{ at } 1.05 U_e = 435 \text{ V}$



- 1 Maximum peak current
- 2 32 A
- 3 25 A
- 4 18 A
- 5 14 A
- 6 10 A
- 7 6.3 A
- 8 4 A
- 9 2.5 A
- 10 1.6 A
- 11 Limit of rated ultimate breaking capacity on short-circuit of GV2LE (14, 18, 23, and 25 A ratings).

Thermal Limit on Short-Circuit for GV2L Only

Thermal Limit in kA²s in the Magnetic Operating Zone

Sum of $I^2dt = f$ (prospective Isc) at 1.05 Ue = 435 V

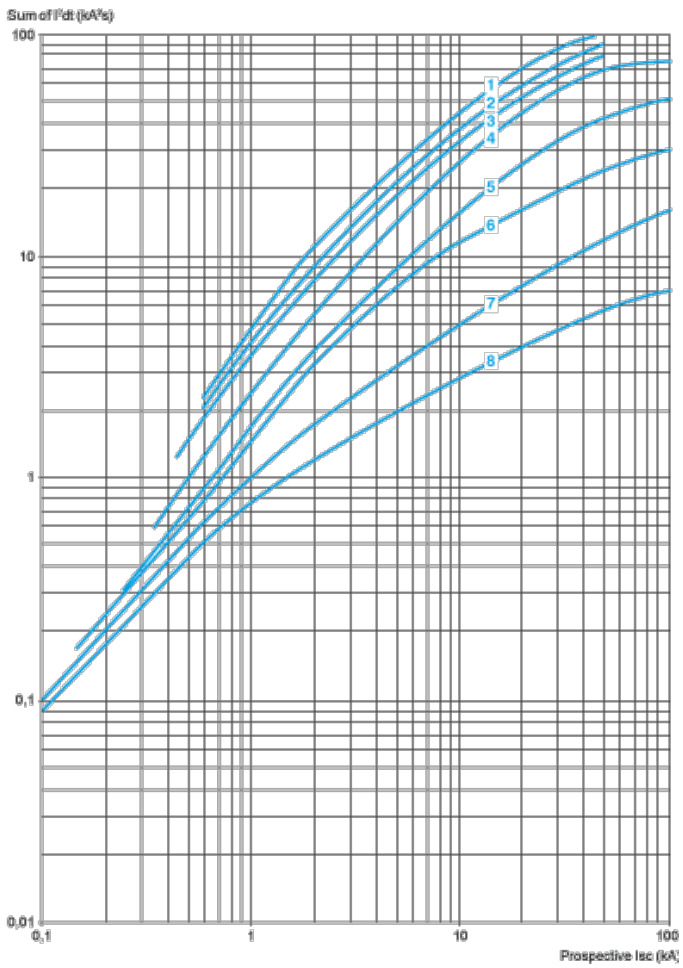

- 1 25 A and 32 A
- 2 18 A
- 3 14 A
- 4 10 A
- 5 6.3 A
- 6 4 A
- 7 2.5 A
- 8 1.6 A

Thermal Limit on Short-Circuit for GV2L and GV2LE + Thermal Overload Relay LRD or LR2K

Thermal Limit in kA²s in the Magnetic Operating Zone

Sum of $I^2dt = f$ (prospective Isc) at $1.05 U_e = 435 V$



- 1 32 A (GV2LE32)
- 2 25 A and 32 A (GV2L32)
- 3 18 A
- 4 14 A
- 5 10 A
- 6 6.3 A
- 7 4 A
- 8 2.5 A
- 9 1.6 A
- 10 Limit of rated ultimate breaking capacity on short-circuit of GV2 LE (14, 18, 23, and 25 A ratings).

GV2L

Dimensions

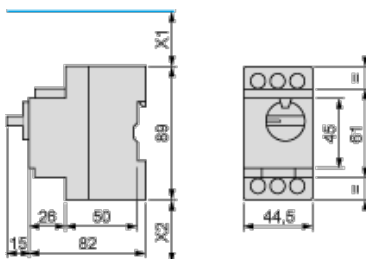

X1 Electrical clearance = 40 mm for $U_e \leq 415$ V, or 80 mm for $U_e = 440$ V, or 120 mm for $U_e = 500$ and 690 V.
 X2 = 40 mm.

GVAD, AM, AN, AU, AS

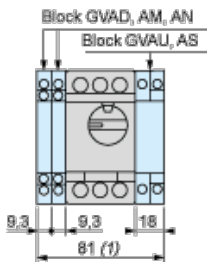

1 Maximum
GV2AK00

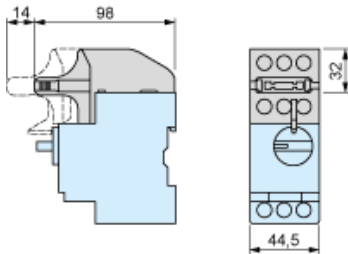

Mounting

On rail AM1 DE200, AM1 ED200 (35 x 15)

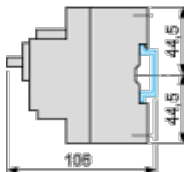

Panel mounted



On pre-slotted mounting plate AM1 PA

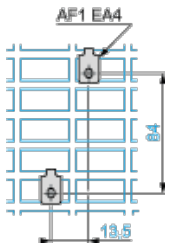

Adapter Plate GK2AF01

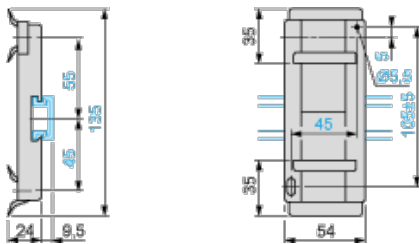

7.5 mm Height Compensation Plate GV1F03



Mounting

Mounting of External Operator GV2APN01, GV2APN02 or GV2APN04 for Motor Circuit Breakers GV2L

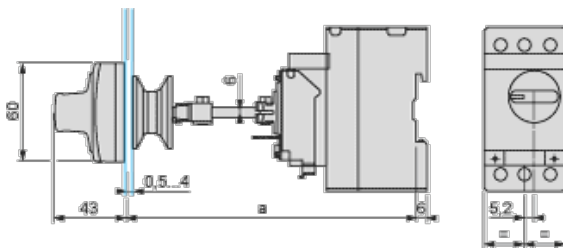

Door cut-out

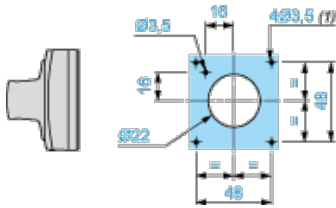

(1) For IP65 only.

Mounting of External Operator GVAPH02 for Motor Circuit Breakers GV2L

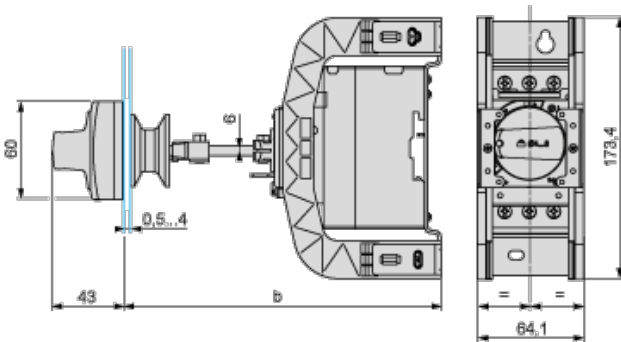

	b	
	Minimum	Maximum
GV2 APN.. + GV APH02	151	250
GV2 APN.. + GV APH02 + GV APK11	250	445

Door cut-out

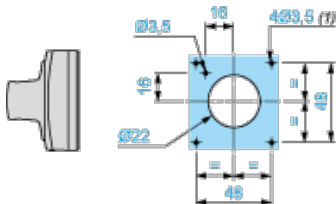

(1) For IP65 only.

GV2L and GV2LE

Sets of busbars GV2G445, GV2G454, GV2G472, with terminal block GV2G05

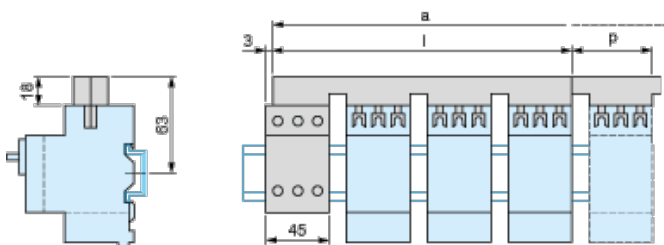

	l	p
GV2G445 (4 x 45 mm)	179	45
GV2G454 (4 x 54 mm)	206	54
GV2G472 (4 x 72 mm)	260	72

Number of tap-offs	a			
	5	6	7	8

GV2G445	224	269	314	359
GV2G454	260	314	368	422
GV2G472	332	404	476	548

Sets of Busbars for GV2L and GV2LE

Sets of busbars GV2G... with terminal block GV1G09

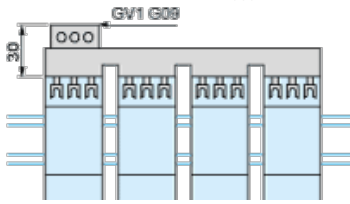

Sets of busbars GV2G245, GV2G254, GV2GR272

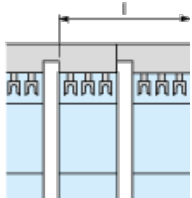

	I
GV2G245 (2 x 45 mm)	89
GV2G254 (2 x 54 mm)	98
GV2G272 (2 x 72 mm)	116

Set of busbars GV2G554

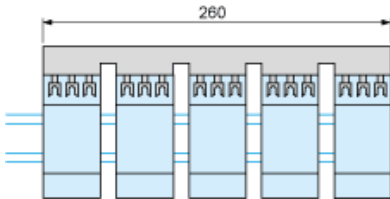

Sets of busbars GV2G345 and GV2G354

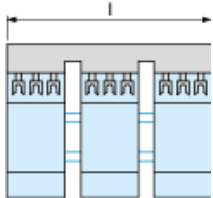

	I
GV2G345 (3 x 45 mm)	134
GV2G354 (3 x 54 mm)	152

GV2L••

