



Principale

Gamma prodotto	Harmony XAC
Tipo di prodotto o componente	Stazione di comando pensile
Nome abbreviato	XACB

Complementare

Tipo pannello di controllo	Doppio isolamento
Materiale contenitore	Poliestere con fibra di vetro
Tipo di circuito elettrico	Circuito di controllo Circuito di potenza
Tipo di cassetta	Cassetta vuota
Numero di fori	3 fori
Colore stazione di controllo	Giallo
Entrata cavo	Manicotto in gomma con ingresso a gradini 7...13 mm
Corrimano	Senza
Centro forato comando verticale	40 mm
Norme di riferimento	EN/IEC 60947-5-1 CSA C22.2 No 14
Certificazioni prodotto	CSA tipo 4
Trattamento di protezione	TH
Temperatura ambiente di funzionamento	-25...70°C
Temperatura di stoccaggio	-40...70°C
Resistenza alle vibrazioni	15 gn 10...500 Hz IEC 60068-2-6
Resistenza agli shock	100 gn IEC 60068-2-27
Categoria di sovratensione	Classe II IEC 61140
Grado di protezione IP	IP65 IEC 60529
Grado di protezione IK	IK08 EN 50102
Durata meccanica	1000000 cicli
Peso prodotto	0,76 kg

Ambiente

Dimensions

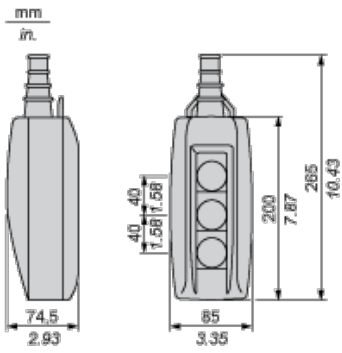

Protective cable sleeves

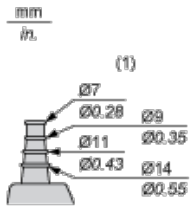

(1) Internal \varnothing

Control of Single-Speed Reversing Motor

With XESD1181 contact block, to be ordered separately

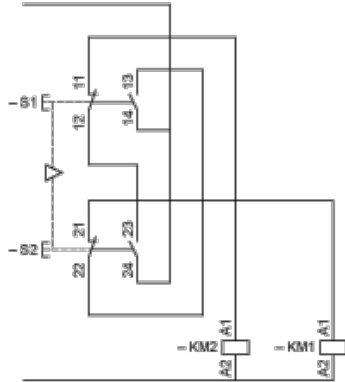

Control of 2-Speed Reversing Motor

With XESD1281 contact block, to be ordered separately

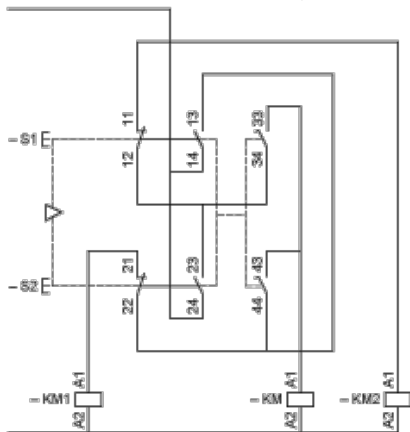

KM High speed contactor

Control of Single-Speed Reversing Motor 2-Phase Switching

With XESD1191 contact block, to be ordered separately

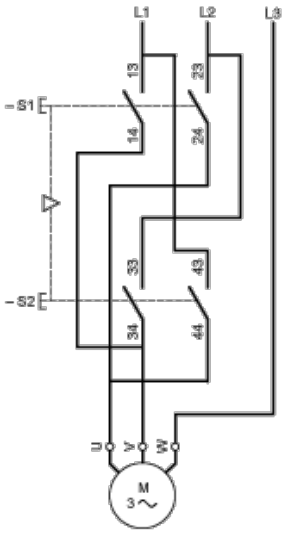

Combined with 3-pole isolating block XACS399 or XACS3991, shown in the unoperated position (pendant station "supplied"), fitted with key release trigger action latching Emergency stop operator.

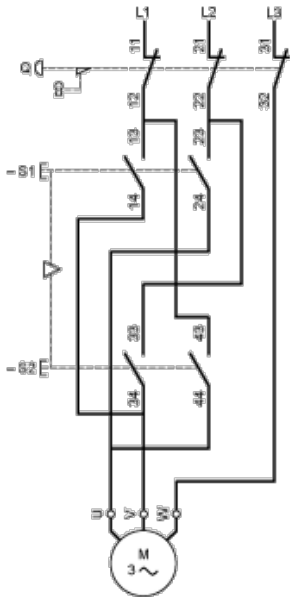

Control of 2-Speed Reversing Motor 2-Phase Switching

With XESD1291 contact block, to be ordered separately

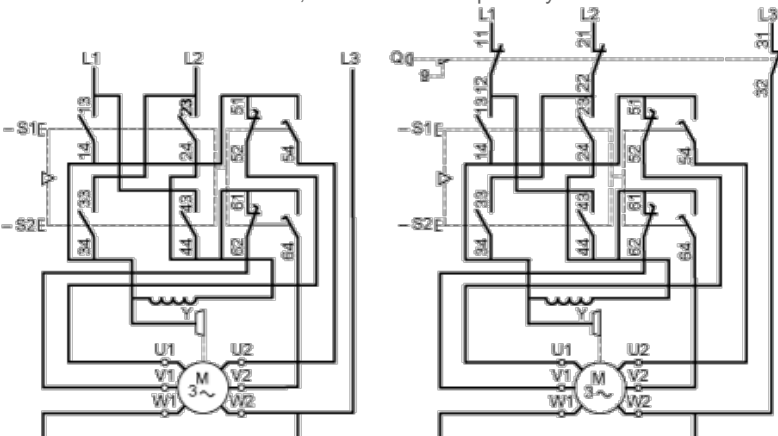

Control of Single-Speed Reversing Motor 3-Phase switching, Reversing by 2-Phase Inversion

With XESD2201 contact block, to be ordered separately

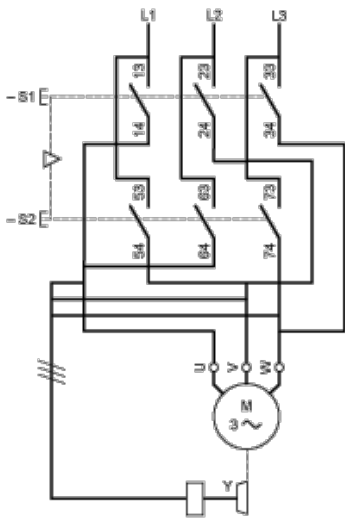

Control of Single-Speed Reversing Motor 3-Phase switching, Reversing by 2-Phase Inversion

With XESD2241 contact block, to be ordered separately

