



Model 88 V Automotive Multimeter Quick Reference Guide

 See *Users Manual* for "Safety Information" and complete operating information.

Fuse Test

 + LEAd =  OK

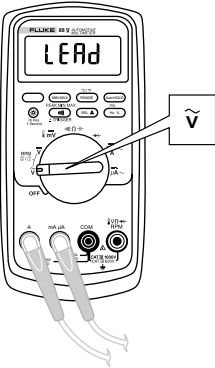

Test Lead Alert

 + LEAd = 

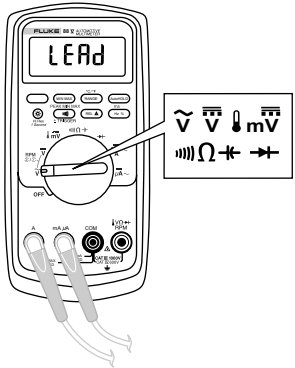

Voltage

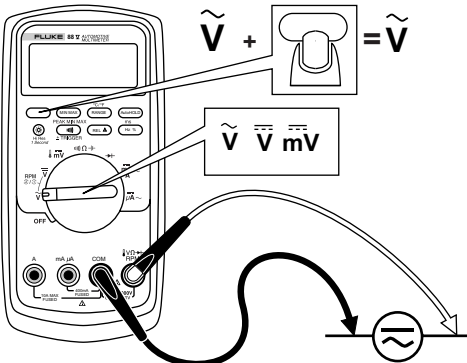

Temperature

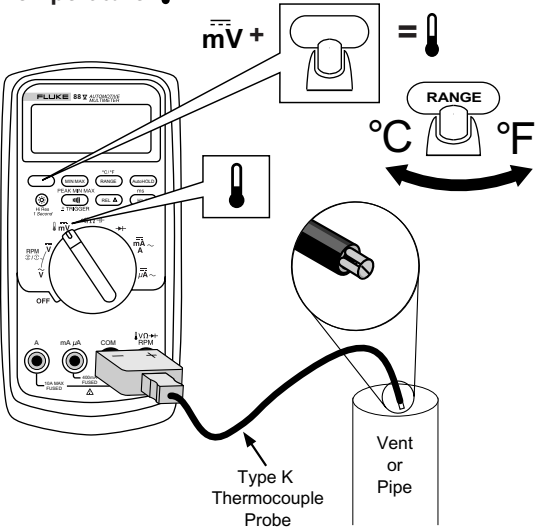

Resistance Ω

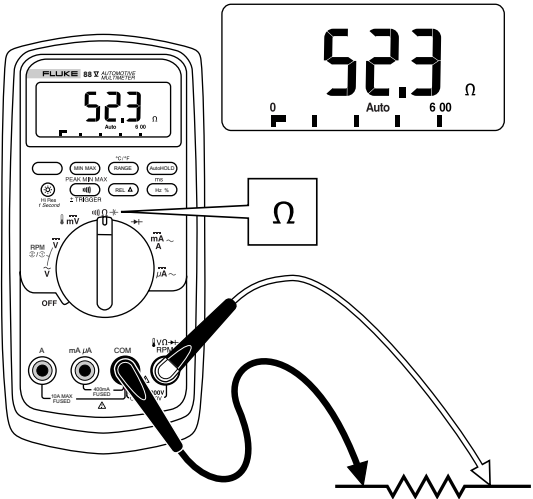

Conductance nS

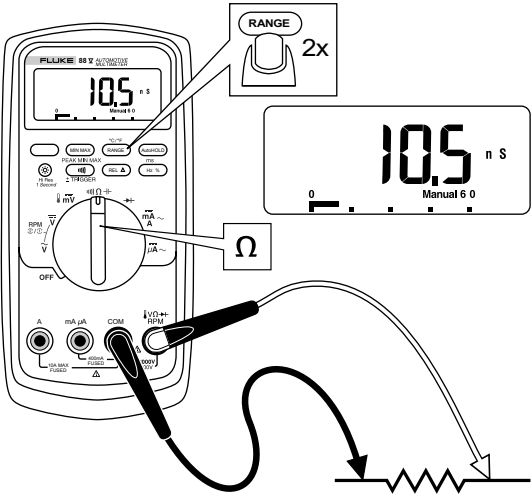

Continuity)))

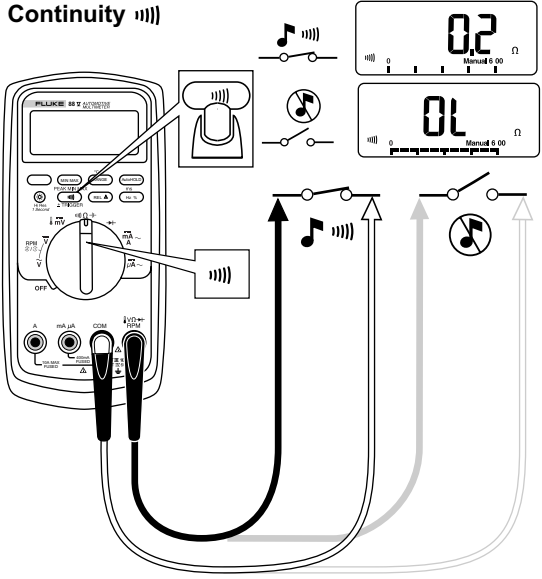

Smoothing (Power Up Option Only)

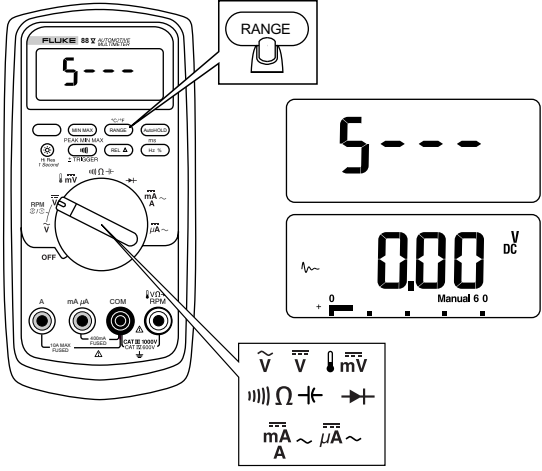

Current mA, A, μA, mA, A, μA

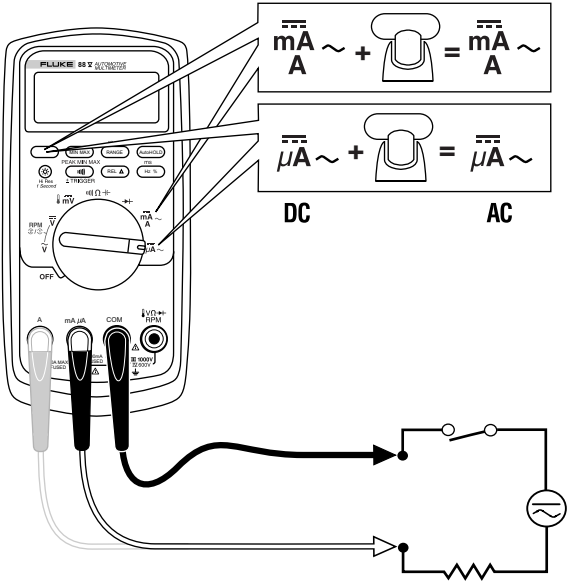

Diode Test →

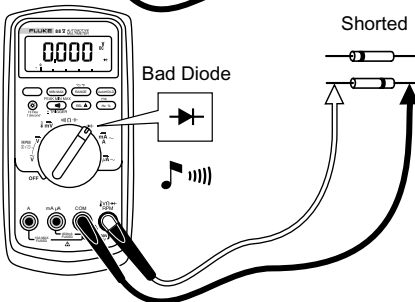
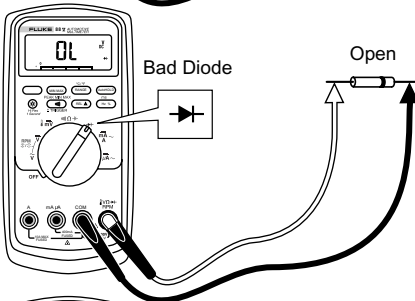
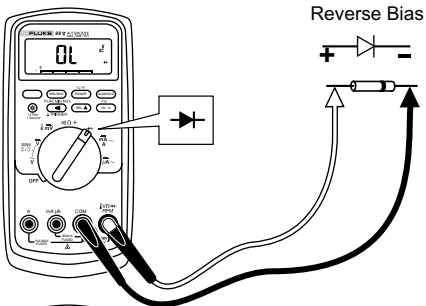
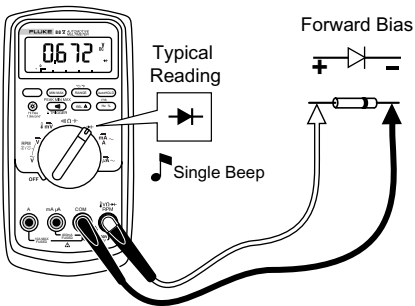

DUTY CYCLE (%)	DWELL (NO. OF CYLINDERS)					DUTY CYCLE (%)	DWELL (NO. OF CYLINDERS)				
	3	4	5	6	8		3	4	5	6	8
0	0.0	0.0	0.0	0.0	0.0	50	60.0	45.0	36.0	30.0	22.5
1	1.2	0.9	0.7	0.6	0.5	51	61.2	45.9	36.7	30.6	23.0
2	2.4	1.8	1.4	1.2	0.9	52	62.4	46.8	37.4	31.2	23.4
3	3.6	2.7	2.2	1.8	1.4	53	63.6	47.7	38.2	31.8	23.9
4	4.8	3.6	2.9	2.4	1.8	54	64.8	48.6	38.9	32.4	24.3
5	6.0	4.5	3.6	3.0	2.3	55	66.0	49.5	39.6	33.0	24.8
6	7.2	5.4	4.3	3.6	2.7	56	67.2	50.4	40.3	33.6	25.2
7	8.4	6.3	5.0	4.2	3.2	57	68.4	51.3	41.0	34.2	25.7
8	9.6	7.2	5.8	4.8	3.6	58	69.6	52.2	41.8	34.8	26.1
9	10.8	8.1	6.5	5.4	4.1	59	70.8	53.1	42.5	35.4	26.6
10	12.0	9.0	7.2	6.0	4.5	60	72.0	54.0	43.2	36.0	27.0
11	13.2	9.9	7.9	6.6	5.0	61	73.2	54.9	43.9	36.6	27.5
12	14.4	10.8	8.6	7.2	5.4	62	74.4	55.8	44.6	37.2	27.9
13	15.6	11.7	9.4	7.8	5.9	63	75.6	56.7	45.4	37.8	28.4
14	16.8	12.6	10.1	8.4	6.3	64	76.8	57.6	46.1	38.4	28.8
15	18.0	13.5	10.8	9.0	6.8	65	78.0	58.5	46.8	39.0	29.3
16	19.2	14.4	11.5	9.6	7.2	66	79.2	59.4	47.5	39.6	29.7
17	20.4	15.3	12.2	10.2	7.7	67	80.4	60.3	48.2	40.2	30.2
18	21.6	16.2	13.0	10.8	8.1	68	81.6	61.2	49.0	40.8	30.6
19	22.8	17.1	13.7	11.4	8.6	69	82.8	62.1	49.7	41.4	31.1
20	24.0	18.0	14.4	12.0	9.0	70	84.0	63.0	50.4	42.0	31.5
21	25.2	18.9	15.1	12.6	9.5	71	85.2	63.9	51.1	42.6	32.0
22	26.4	19.8	15.8	13.2	9.9	72	86.4	64.8	51.8	43.2	32.4
23	27.6	20.7	16.6	13.8	10.4	73	87.6	65.7	52.6	43.8	32.9
24	28.8	21.6	17.3	14.4	10.8	74	88.8	66.6	53.3	44.4	33.3
25	30.0	22.5	18.0	15.0	11.3	75	90.0	67.5	54.0	45.0	33.8
26	31.2	23.4	18.7	15.6	11.7	76	91.2	68.4	54.7	45.6	34.2
27	32.4	24.3	19.4	16.2	12.2	77	92.4	69.3	55.4	46.2	34.7
28	33.6	25.2	20.2	16.8	12.6	78	93.6	70.2	56.2	46.8	35.1
29	34.8	26.1	20.9	17.4	13.1	79	94.8	71.1	56.9	47.4	35.6
30	36.0	27.0	21.6	18.0	13.5	80	96.0	72.0	57.6	48.0	36.0
31	37.2	27.9	22.3	18.6	14.0	81	97.2	72.9	58.3	48.6	36.5
32	38.4	28.8	23.0	19.2	14.4	82	98.4	73.8	59.0	49.2	36.9
33	39.6	29.7	23.8	19.8	14.9	83	99.6	74.7	59.8	49.8	37.4
34	40.8	30.6	24.5	20.4	15.3	84	100.8	75.6	60.5	50.4	37.8
35	42.0	31.5	25.2	21.0	15.8	85	102.0	76.5	61.2	51.0	38.3
36	43.2	32.4	25.9	21.6	16.2	86	103.2	77.4	61.9	51.6	38.7
37	44.4	33.3	26.6	22.2	16.7	87	104.4	78.3	62.6	52.2	39.2
38	45.6	34.2	27.4	22.8	17.1	88	105.6	79.2	63.4	52.8	39.6
39	46.8	35.1	28.1	23.4	17.6	89	106.8	80.1	64.1	53.4	40.1
40	48.0	36.0	28.8	24.0	18.0	90	108.0	81.0	64.8	54.0	40.5
41	49.2	36.9	29.5	24.6	18.5	91	109.2	81.9	65.5	54.6	41.0
42	50.4	37.8	30.2	25.2	18.9	92	110.4	82.8	66.2	55.2	41.4
43	51.6	38.7	31.0	25.8	19.4	93	111.6	83.7	67.0	55.8	41.9
44	52.8	39.6	31.7	26.4	19.8	94	112.8	84.6	67.7	56.4	42.3
45	54.0	40.5	32.4	27.0	20.3	95	114.0	85.5	68.4	57.0	42.8
46	55.2	41.4	33.1	27.6	20.7	96	115.2	86.4	69.1	57.6	43.2
47	56.4	42.3	33.8	28.2	21.2	97	116.4	87.3	69.8	58.2	43.7
48	57.6	43.2	34.6	28.8	21.6	98	117.6	88.2	70.6	58.8	44.1
49	58.8	44.1	35.3	29.4	22.1	99	118.8	89.1	71.3	59.4	44.6

Duty Cycle %/Dwell

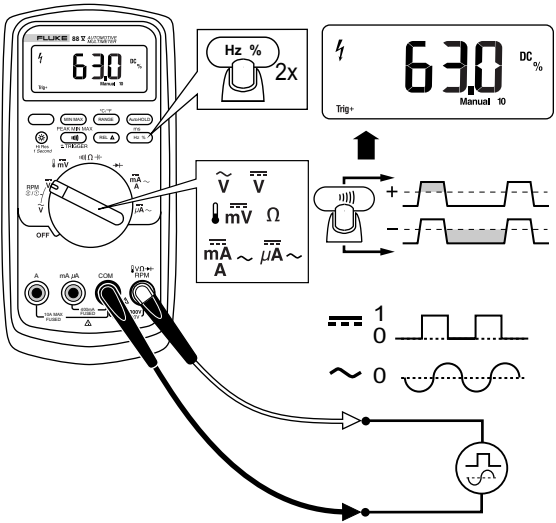

Frequency (Hz)

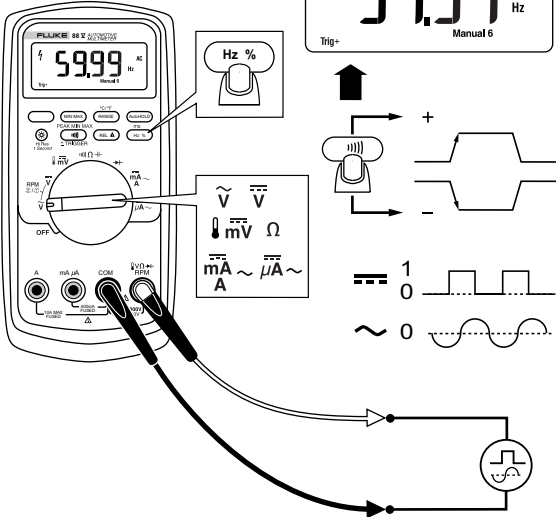

Pulse Width (ms)

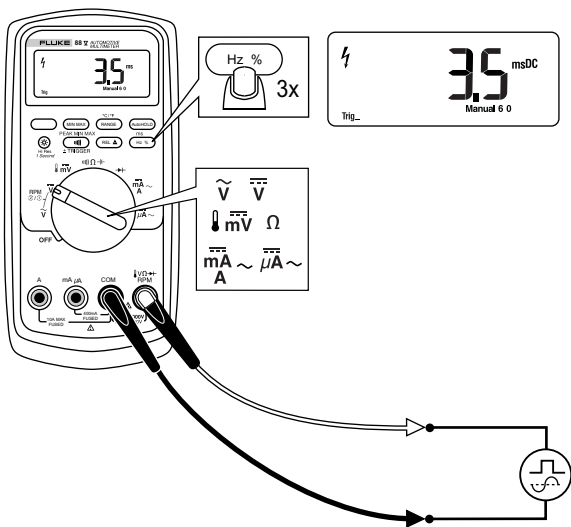

RPM $\text{②}/\text{①}$

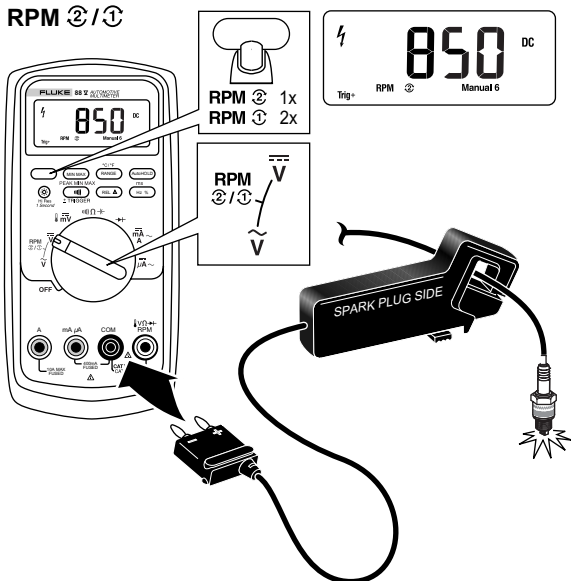

Min, Max, Average **MIN MAX**

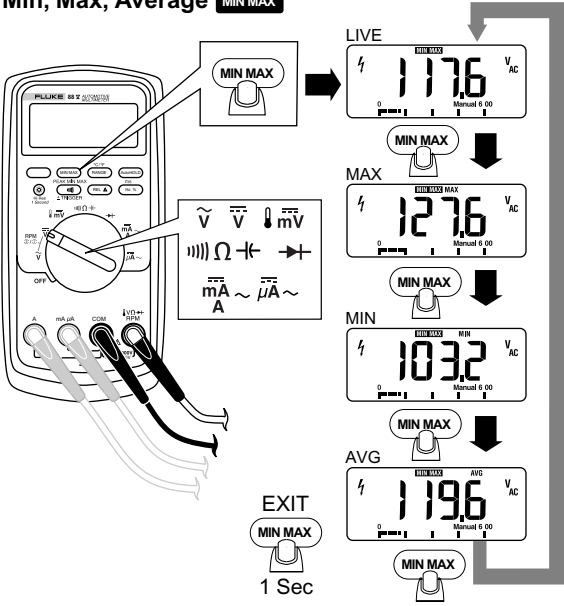

AutoHOLD **HOLD**

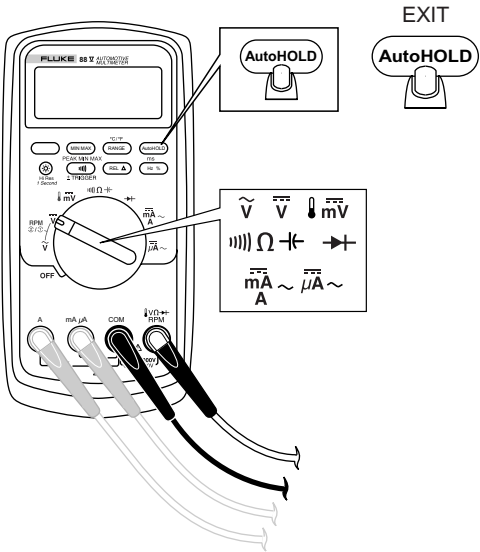

Relative Δ (Zero)

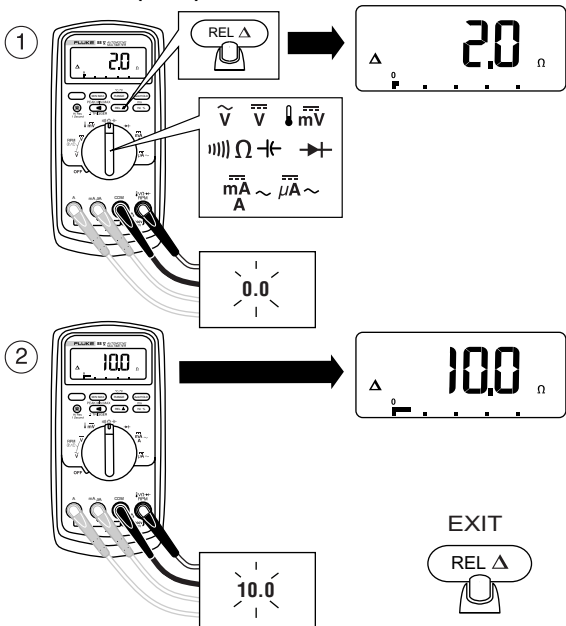

Hi Res Mode

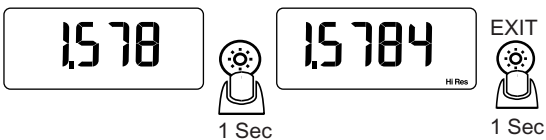

ToolPak

