



Main

Range of Product	Harmony Electromechanical Relays
Series name	Power
Product or Component Type	Plug-in relay
Device short name	RPM
Contacts type and composition	4 C/O
[Uc] control circuit voltage	120 V AC 50/60 Hz
[Ithe] conventional enclosed thermal current	15 A -40...131 °F (-40...55 °C)
Status LED	With
Control Type	Lockable test button
Utilisation coefficient	20 %

Complementary

Shape of pin	Flat
[Ui] rated insulation voltage	250 V IEC 300 V CSA 300 V UL
[Uimp] rated impulse withstand voltage	4 kV 1.2/50 µs
Contacts material	AgNi
[Ie] rated operational current	15 A 277 V AC) UL 15 A 28 V DC) UL 15 A 250 V AC) NO IEC 15 A 28 V DC) NO IEC 7.5 A 250 V AC) NC IEC 7.5 A 28 V DC) NC IEC
Maximum switching voltage	250 V IEC
Resistive load current	15 A 250 V AC 15 A 28 V DC
Maximum switching capacity	3750 VA 420 W
Minimum switching capacity	170 mW 10 mA, 17 V
Operating rate	<= 1200 cycles/hour under load <= 18000 cycles/hour no-load
Mechanical durability	10000000 cycles
Electrical durability	100000 cycles resistive
Average coil consumption in VA	2.5 60 Hz
Drop-out voltage threshold	>= 0.15 U _c AC
Operate time	20 ms at nominal voltage
Release time	20 ms at nominal voltage
Average coil resistance	2100 Ohm at 68 °F (20 °C) +/- 15 %
Rated operational voltage limits	96...132 V AC
Protection category	RT I
Test levels	Level A
Operating position	Any position
Pollution degree	3
Safety reliability data	B10d = 100000

The information provided in this documentation contains general descriptions and/or technical characteristics of the performance of the products contained herein. This documentation is not intended as a substitute for and is not to be used for determining suitability or reliability of these products for specific user applications. It is the duty of any such user or integrator to perform the appropriate and complete risk analysis, evaluation and testing of the products with respect to the relevant specific application or use thereof. Neither Schneider Electric Industries SAS nor any of its affiliates or subsidiaries shall be responsible or liable for misuse of the information contained herein.

Net Weight	0.16 lb(US) (0.071 kg)
Device presentation	Complete product

Environment

Dielectric strength	1500 V AC between contacts with micro disconnection 2000 V AC between coil and contact with reinforced 2000 V AC between poles with basic
Standards	CSA C22.2 No 14 UL 508 EN/IEC 61810-1
Product Certifications	UL EAC CSA
Ambient Air Temperature for Storage	-40...185 °F (-40...85 °C)
Ambient air temperature for operation	-40...131 °F (-40...55 °C)
Vibration resistance	3 gn +/- 1 mm 10...150 Hz)5 cycles in operation 5 gn +/- 1 mm 10...150 Hz)5 cycles not operating
Degree of protection (Housing only)	IP40 conforming to EN/IEC 60529
Shock resistance	15 gnin operation 30 gnnot operating

Ordering and shipping details

Category	21127-ZELIO ICE CUBE RELAYS
Discount Schedule	CP2
GTIN	3389119402248
Returnability	Yes
Country of origin	CN

Packing Units

Unit Type of Package 1	PCE
Number of Units in Package 1	1
Package 1 Height	0.94 in (2.4 cm)
Package 1 Width	1.30 in (3.3 cm)
Package 1 Length	1.97 in (5.0 cm)
Package 1 Weight	2.54 oz (72.0 g)

Offer Sustainability

Sustainable offer status	Green Premium product
California proposition 65	WARNING: This product can expose you to chemicals including: Nickel compounds, which is known to the State of California to cause cancer, and Di-isodecyl phthalate (DIDP), which is known to the State of California to cause birth defects or other reproductive harm. For more information go to www.P65Warnings.ca.gov
REACH Regulation	REACH Declaration
REACH free of SVHC	Yes
EU RoHS Directive	Pro-active compliance (Product out of EU RoHS legal scope) EU RoHS Declaration
Toxic heavy metal free	Yes
Mercury free	Yes
China RoHS Regulation	China RoHS Declaration
RoHS exemption information	Yes
Environmental Disclosure	Product Environmental Profile
WEEE	The product must be disposed on European Union markets following specific waste collection and never end up in rubbish bins.

Contractual warranty

Warranty	18 months
----------	-----------

Dimensions

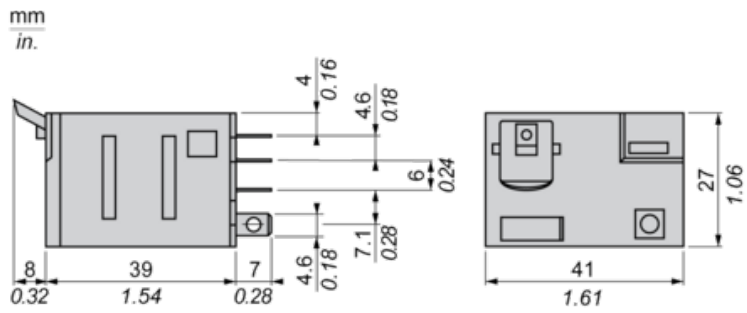

Pin Side View

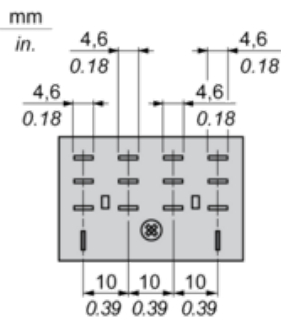

Wiring Diagram

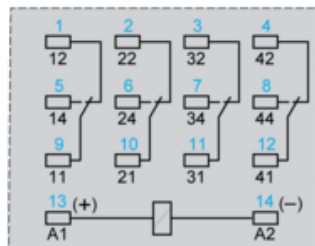
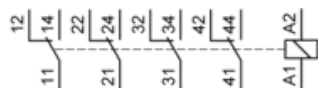

Symbols shown in blue correspond to Nema marking.

Electrical Durability of Contacts

Durability (inductive load) = durability (resistive load) x reduction coefficient.

Resistive AC load

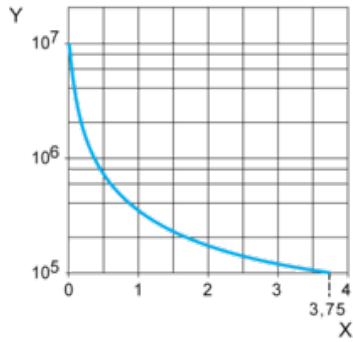

X Switching capacity (kVA)

Y Durability (Number of operating cycles)

Reduction coefficient for inductive AC load (depending on power factor $\cos \phi$)

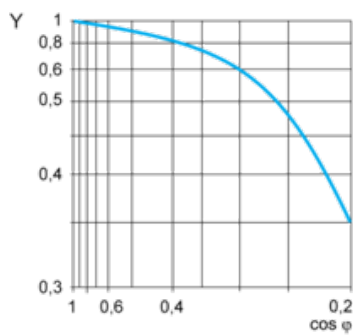

Y Reduction coefficient (A)

Maximum switching capacity on resistive DC load

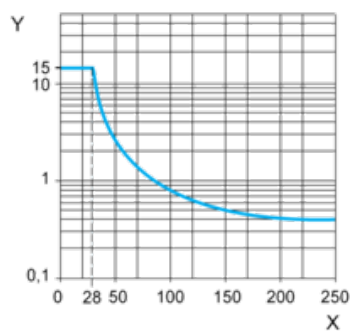

X Voltage DC

Y Current DC

Note : These are typical curves, actual durability depends on load, environment, duty cycle, etc.