



Main

Range of Product	Modicon ABE7
Product or Component Type	Sub-base with plug-in electromechanical relay
Sub-base type	Output sub-base
[Us] rated supply voltage	19...30 V IEC 61131-2
Number of Channels	16

Complementary

Supply voltage type	DC
Product Compatibility	ABR7S37
Status LED	1 LED per channel (Green) channel status 1 LED (Green) power ON
Polarity distribution	Volt-free
Short-circuit protection	1 A internal fuse, 5 x 20 mm, fast blow PLC end)
Fixing mode	By clips 35 mm symmetrical DIN rail) By screws solid plate with fixing kit)
Maximum supply current	1 A
Voltage drop on power supply fuse	0.3 V
[Ui] rated insulation voltage	2000 V terminals/mounting rails 300 V coil circuit/contact circuits IEC 60947-1
[Uimp] rated impulse withstand voltage	2.5 kV
Installation category	II IEC 60664-1
Tightening torque	5.31 lbf.in (0.6 N.m) flat Ø 3.5 mm
Net Weight	2.87 lb(US) (1.3 kg)

Environment

Product Certifications	DNV CSA GL EAC
IP degree of protection	IP2X conforming to IEC 60529
Resistance to incandescent wire	1382 °F (750 °C) IEC 60695-2-11
Shock resistance	15 gn 11 ms IEC 60068-2-27
Vibration resistance	2 gn 10...150 Hz)IEC 60068-2-6
Resistance to electrostatic discharge	4 kV contact) level 3 IEC 61000-4-2 8 kV air) level 3 IEC 61000-4-2
Resistance to radiated fields	9.14 V/m (10 V/m) 26000000...100000000 Hz)IEC 61000-4-3 level 3
Resistance to fast transients	2 kV level 3 IEC 61000-4-4
Ambient air temperature for operation	23...140 °F (-5...60 °C) IEC 61131-2
Ambient air temperature for storage	-40...176 °F (-40...80 °C) IEC 61131-2
Pollution degree	2 IEC 60664-1

Ordering and shipping details

Category	22375-INTERFACE MODULE(ABA,R,S)
Discount Schedule	CP2
GTIN	3389110705119
Returnability	No
Country of origin	LV

Packing Units

Unit Type of Package 1	PCE
Number of Units in Package 1	1
Package 1 Height	3.35 in (8.5 cm)
Package 1 Width	3.94 in (10.0 cm)
Package 1 Length	11.50 in (29.2 cm)
Package 1 Weight	2.60 lb(US) (1.181 kg)
Unit Type of Package 2	S03
Number of Units in Package 2	6
Package 2 Height	11.81 in (30.0 cm)
Package 2 Width	11.81 in (30.0 cm)
Package 2 Length	15.75 in (40.0 cm)
Package 2 Weight	16.66 lb(US) (7.557 kg)

Offer Sustainability

Sustainable offer status	Green Premium product
California proposition 65	WARNING: This product can expose you to chemicals including: Lead and lead compounds, which is known to the State of California to cause cancer and birth defects or other reproductive harm. For more information go to www.P65Warnings.ca.gov
REACH Regulation	REACH Declaration
REACH free of SVHC	Yes
EU RoHS Directive	Pro-active compliance (Product out of EU RoHS legal scope) EU RoHS Declaration
Mercury free	Yes
China RoHS Regulation	China RoHS Declaration
RoHS exemption information	Yes
Environmental Disclosure	Product Environmental Profile
Circularity Profile	End Of Life Information
WEEE	The product must be disposed on European Union markets following specific waste collection and never end up in rubbish bins.

Contractual warranty

Warranty	18 months
----------	-----------

Dimensions

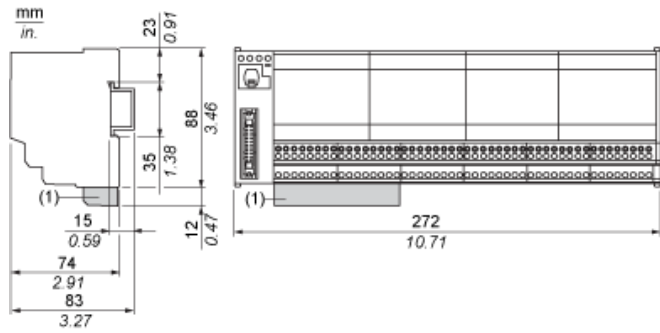

(1) ABE7BV10 / BV20, ABE7BV10E / BV20E

Mounting

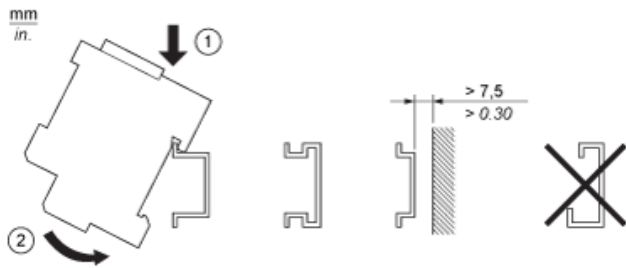

HE10 16 Channels

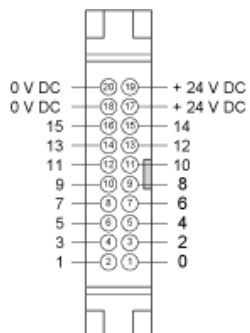

Wiring Diagram with Other Relays not Supplied

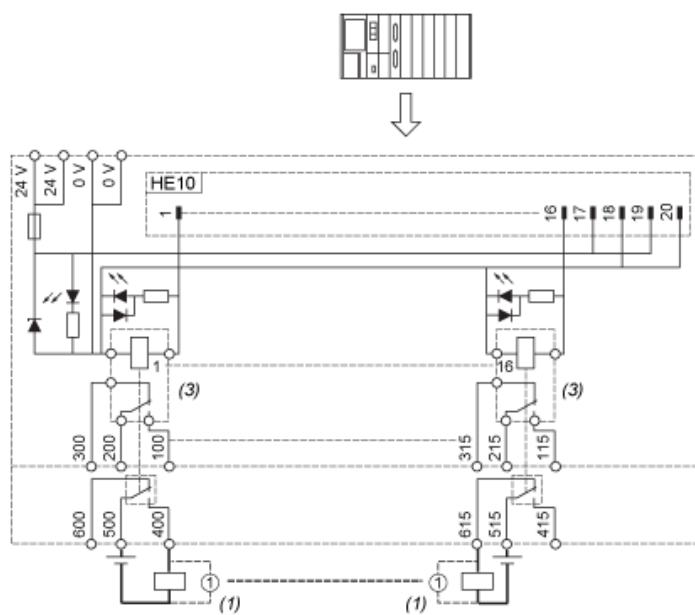

- (1) Inductive load
- (3) ABR7S37 (2 "OF" "DPDT") Ith = 8 A (supplied)

Curves for Determining Cable Type and Length According to the Current

16-channel Sub-base

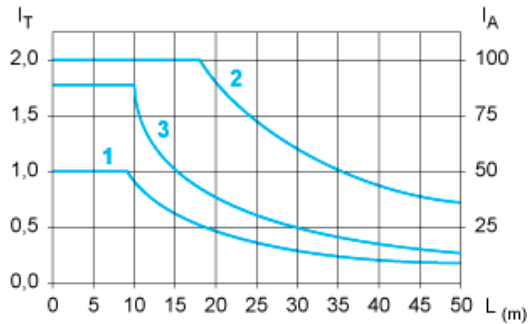

- L Cable length
- I_T Total current per sub base (A)
- I_A Average current per channel (mA)
- (1) TSXC DP••2 and ABFH20H••0 cables with c.s.a. 0.08 mm² (AWG 28).
- (2) TSXC DP••3 cables with c.s.a. 0.34 mm² (AWG 22).
- (3) Cables with c.s.a. 0.13 mm² (AWG 26).

The curves are given for a voltage drop of 1 V in the cable. For n volts tolerance, multiply the length determined from the graph by n.

Temperature Derating Curves

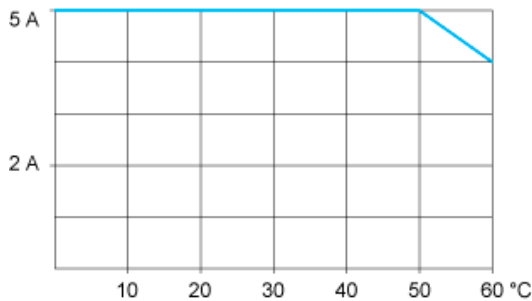

Electrical Durability (in Millions of Operating Cycles) Conforming to IEC 60947-5-1

DC Loads

DC12 curves

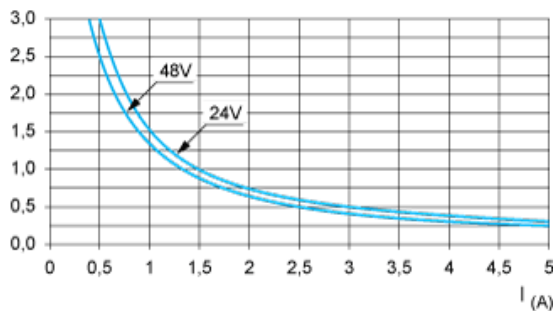

DC12control of resistive loads and of solid state loads isolated by optocoupler, I/R ≤ 1 ms.

DC13 curves

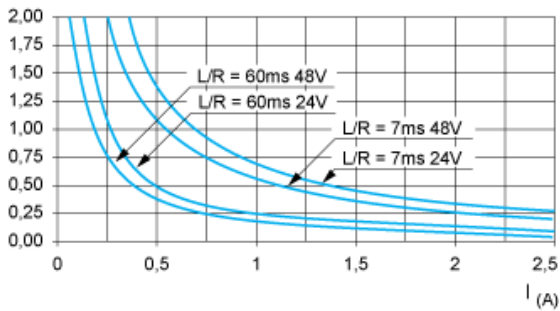

DC13 Switching electromagnets, $L/R \leq 2 \times (U_e \times I_e)$ in ms, U_e : rated operational voltage, I_e : rated operational current (with a protective diode on the load, DC12 curves must be used with a coefficient of 0.9 applied to the number in millions of operating cycles)

AC Loads

AC12 curves

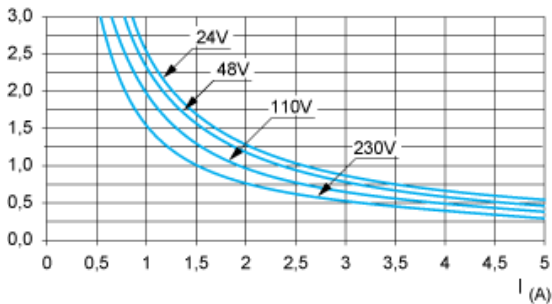

AC12 control of resistive loads and of solid state loads isolated by optocoupler, $\cos \phi \geq 0.9$.

AC14 curves

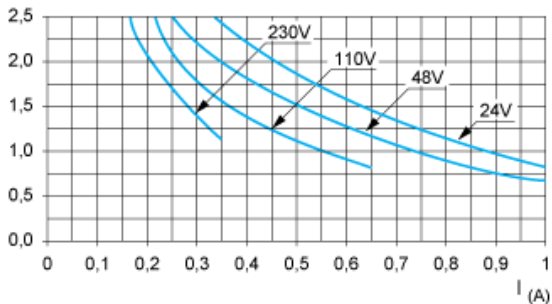

AC14 control of small electromagnetic loads ≤ 72 VA, make: $\cos \phi = 0.3$, break: $\cos \phi = 0.3$.

AC15 curves

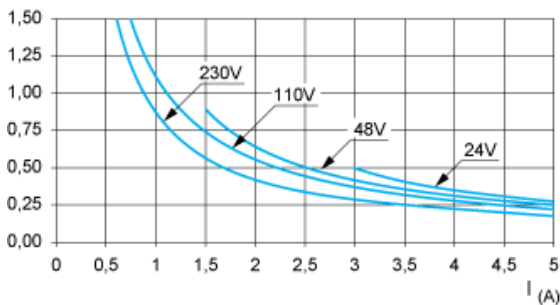

AC15 control of electromagnetic loads > 72 VA, make: $\cos \phi = 0.7$, break: $\cos \phi = 0.4$.