



Main

Range of Product	TeSys GV4
Range	TeSys Deca TeSys Deca
Device short name	GV4PE
Product name	TeSys GV4 TeSys Deca
Product or Component Type	Motor circuit breaker
Device Application	Motor protection
Trip unit technology	Thermal-magnetic Electronic

Complementary

Poles description	3P
Utilisation category	Category A IEC 60947-2 AC-3 IEC 60947-4-1
Operating position	Any position
Motor power kW	37 KW 400...415 V AC 50/60 Hz 45 KW 500 V AC 50/60 Hz 22 KW 400...415 V AC 50/60 Hz 30 KW 500 V AC 50/60 Hz 37 KW 660...690 V AC 50/60 Hz 45 KW 660...690 V AC 50/60 Hz 55 KW 660...690 V AC 50/60 Hz 30 KW 400...415 V AC 50/60 Hz 37 kW 500 V AC 50/60 Hz
Breaking capacity	100 KA Icu 220...240 V AC 50/60 Hz IEC 60947-2 50 KA Icu 380...415 V AC 50/60 Hz IEC 60947-2 50 KA Icu 440 V AC 50/60 Hz IEC 60947-2 15 KA Icu 525 V AC 50/60 Hz IEC 60947-2 65 KA 208Y/120 V AC 50/60 Hz UL 60947 65 KA 240 V AC 50/60 Hz UL 60947 35 KA 480Y/277 V AC 50/60 Hz UL 60947 8 KA Icu 660...690 V AC 50/60 Hz IEC 60947-2 25 KA Icu 500 V AC 50/60 Hz IEC 60947-2 18 kA 600Y/347 V AC 50/60 Hz UL 60947
Control Type	Toggle
Line Rated Current	80 A
Magnetic tripping current	1360 A
[Ue] rated operational voltage	690 V AC 50/60 Hz IEC 60947-2
[Ui] rated insulation voltage	800 V AC 50/60 Hz IEC 60947-2
[Ith] conventional free air thermal current	115 A IEC 60947-4-1
[Uimp] rated impulse withstand voltage	8 kV IEC 60947-2
Power dissipation per pole	4.6 W
Mechanical durability	40000 cycles
Electrical durability	14000 Cycles AC-3 440 V In/2 7000 cycles AC-3 440 V In
Maximum operating rate	25 cyc/h
Rated duty	Continuous IEC 60947-4-1
Connection pitch	1.06 In (27 mm) without spreaders 1.38 in (35 mm) with spreaders
Connections - terminals	Lugs-ring terminals

The information provided in this documentation contains general descriptions and/or technical characteristics of the performance of the products contained herein. This documentation is not intended as a substitute for and is not to be used for determining suitability or reliability of these products for specific user applications. It is the duty of any such user or integrator to perform the appropriate and complete risk analysis, evaluation and testing of the products with respect to the relevant specific application or use thereof. Neither Schneider Electric Industries SAS nor any of its affiliates or subsidiaries shall be responsible or liable for misuse of the information contained herein.

Tightening torque	79.66 Lbf.in (9 N.m) 0.02...0.15 in ² (16...95 mm ²) 44.25 lbf.in (5 N.m) 0.00...0.02 in ² (1.5...10 mm ²)
Mechanical robustness	Vibrations +/- 1 mm 2...13.2 Hz IEC 60068-2-6 Vibrations 0.7 gn 13.2...100 Hz IEC 60068-2-6 Shocks 15 gn 11 ms IEC 60068-2-27
Phase failure sensitivity	Yes IEC 60947-4-1
Height	6.10 in (155 mm)
Width	3.19 in (81 mm)
Depth	4.57 in (116 mm)
Net Weight	3.20 lb(US) (1.45 kg)
Color	Gray RAL 7016)
Suitability for isolation	Yes IEC 60947-1

Environment

Standards	CSA C22.2 No 60947-4-1 UL 60947-4-1 EN/IEC 60947-4-1 EN/IEC 60947-2
Product Certifications	IEC UL CSA CCC EAC ATEX EU-RO MR
Climatic withstand	IACS E10
IK degree of protection	IK07 IEC 62262
Pollution degree	3
IP degree of protection	IP40 IEC 60529
Ambient Air Temperature for Storage	-58...185 °F (-50...85 °C)
Fire resistance	1760 °F (960 °C) IEC 60695-2-11
Operating altitude	5000 m
Ambient air temperature for operation	-13...158 °F (-25...70 °C)

Ordering and shipping details

Category	22365-TESYS GV4 MOTOR CIRCUIT BREAKERS
Discount Schedule	I11
GTIN	3606481310453
Returnability	No

Packing Units

Unit Type of Package 1	PCE
Number of Units in Package 1	1
Package 1 Height	4.92 in (12.5 cm)
Package 1 Width	3.54 in (9 cm)
Package 1 Length	8.66 in (22 cm)
Package 1 Weight	3.15 lb(US) (1.429 kg)
Unit Type of Package 2	S03
Number of Units in Package 2	5
Package 2 Height	11.81 in (30 cm)
Package 2 Width	11.81 in (30 cm)
Package 2 Length	15.75 in (40 cm)
Package 2 Weight	20.94 lb(US) (9.5 kg)
Unit Type of Package 3	PAL
Number of Units in Package 3	256
Package 3 Height	43.31 in (110 cm)
Package 3 Width	31.50 in (80 cm)
Package 3 Length	47.24 in (120 cm)
Package 3 Weight	873.03 lb(US) (396 kg)

Offer Sustainability

Sustainable offer status	Green Premium product
REACH Regulation	REACH Declaration
EU RoHS Directive	Compliant EU RoHS Declaration
Mercury free	Yes
China RoHS Regulation	China RoHS Declaration
RoHS exemption information	Yes
Environmental Disclosure	Product Environmental Profile
Circularity Profile	End Of Life Information
WEEE	The product must be disposed on European Union markets following specific waste collection and never end up in rubbish bins.
PVC free	Yes
Halogen content performance	Halogen free plastic parts product

Contractual warranty

Warranty	18 months
----------	-----------

Thermal-Magnetic Tripping Curves for GV4P, GV4PE, GV4PEM

Average Operating Times at 20 °C Related to Multiples of the Setting Current

Hot state

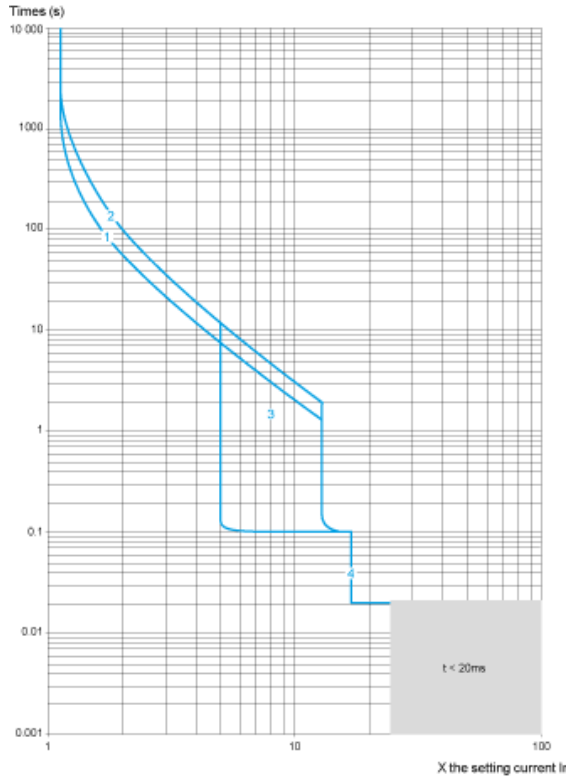

- 1 Class 10
- 2 Class 20
- 3 $I_{sd} = 5 \dots 13 \times I_r$
- 4 $I_i = 17 I_n$

Cold state

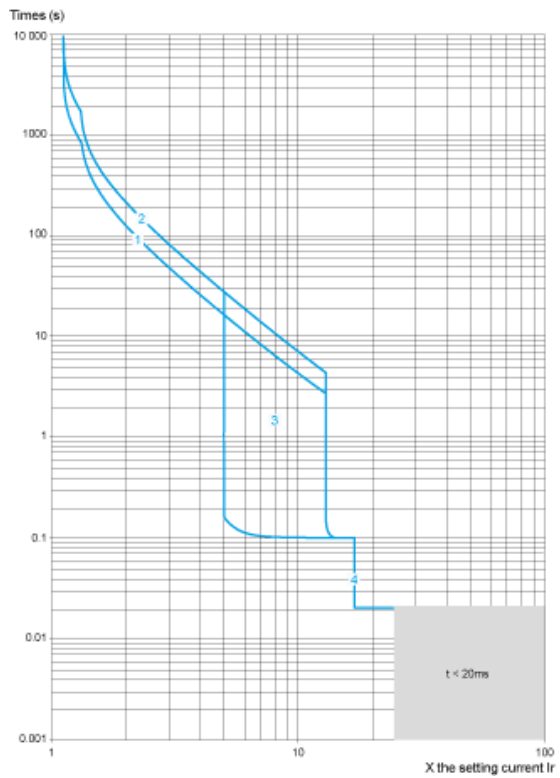

- 1 Class 10
- 2 Class 20
- 3 $I_{sd} = 5 \dots 13 \times I_r$
- 4 $I_i = 17 I_n$

Current Limitation on Short-Circuit for GV4P, GV4PE, GV4PEM (3-Phase 400/415 V)

Dynamic Stress

$I_{\text{peak}} = f(\text{prospective } I_{sc}) \text{ at } 1.05 U_e = 435 \text{ V}$

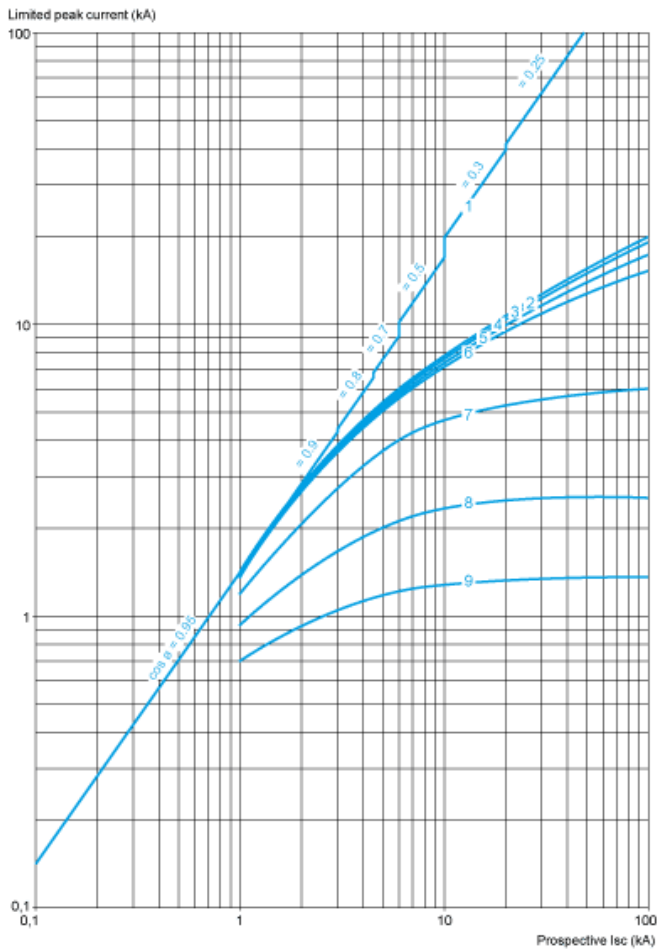

- 1 Maximum peak current
- 2 GV4P115
- 3 GV4P80
- 4 GV4P50
- 5 GV4P25
- 6 GV4P12
- 7 GV4P07
- 8 GV4P03
- 9 GV4P02

Thermal Limit on Short-Circuit for GV4P, GV4PE, GV4PEM

Thermal Limit in kA^2s in the Magnetic Operating Zone

Sum of $I^2dt = f$ (prospective Isc) at 1.05 Ue = 435 V

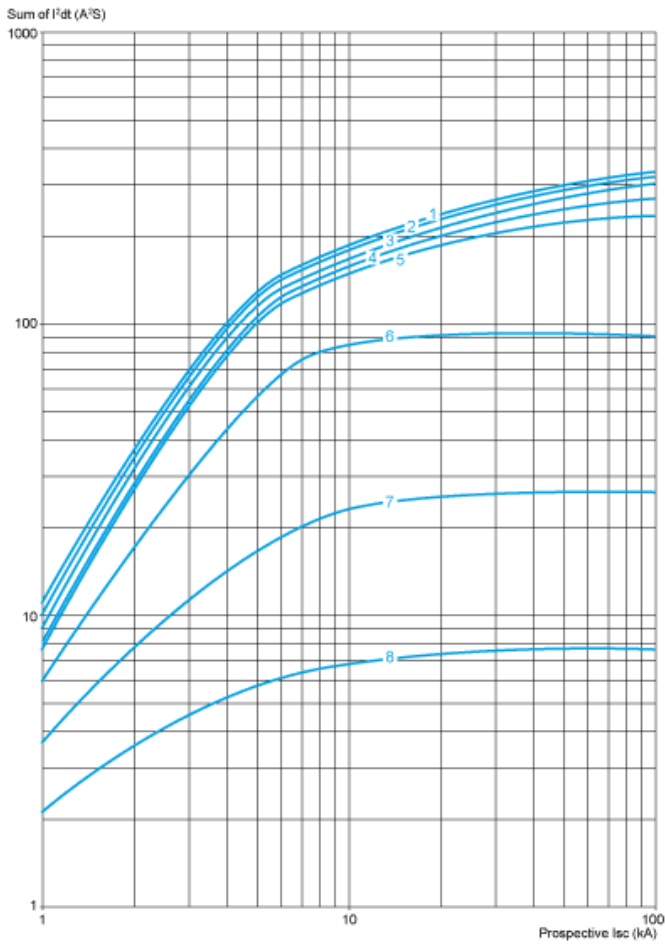

- 1 GV4P115
- 2 GV4P80
- 3 GV4P50
- 4 GV4P25
- 5 GV4P12
- 6 GV4P07
- 7 GV4P03
- 8 GV4P02

GV4 with Toggle: GV4LE, GV4PE, GV4PEM

With EverLink® Connector

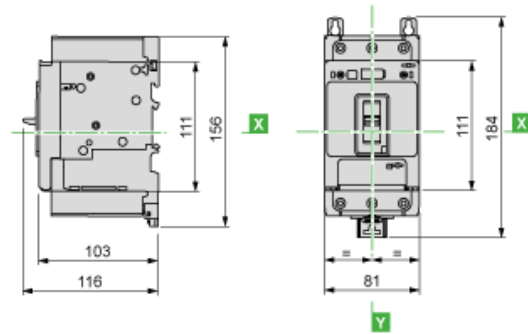

With Crimp Lug Connector

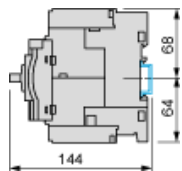

GV4 with Rotary Handle: GV4L, GV4P, or GV4LE, GV4PE, GV4PEM with GV4ADN01, GV4ADN02 Direct Mounting Rotary Handle

Dimensions

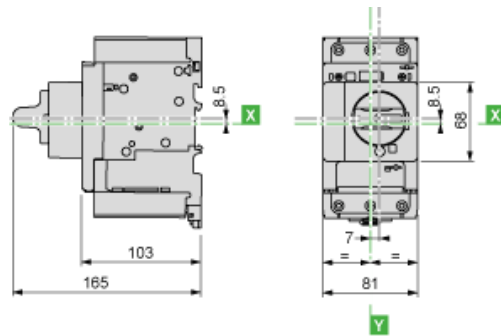

GV4L, GV4P, GV4LE, GV4PE, GV4PEM

Panel Mounting with M4 Screws

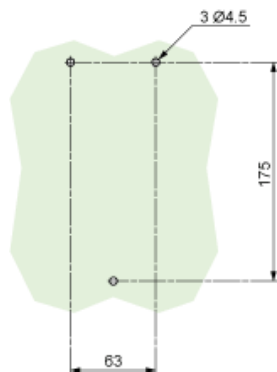

Door Cut-Out for Rotary Handle

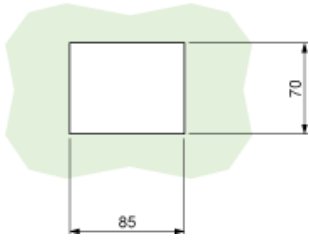

Minimum Safety Clearance

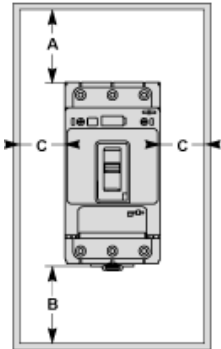

Toggle-type, rotary handle-type: identical clearance values.

Safety Clearance (mm)						
	Painted Sheet Metal			Bare Sheet Metal		
	A	B	C	A	B	C
No accessory	30	0	0	40	0	5
Interphase barriers	0	0	0	0	0	5
Long terminal shield	0	0	0	0	0	5

Magnetic Motor Circuit Breakers

GV4P, GV4PE, GV4PEM

