

PANEL THICKNESS E DIM		NUMBER OF GASKET
IN	MM	
.06	2	4
.13	3	3
.19	5	2
.25	6	1

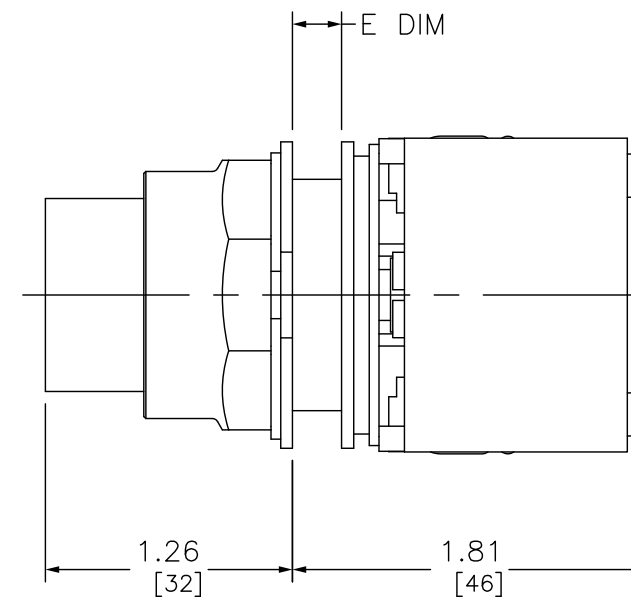

DUAL DIMENSIONS: INCHES
MILLIMETERS

PUSH BUTTON 600VAC 10A 30MM T-K

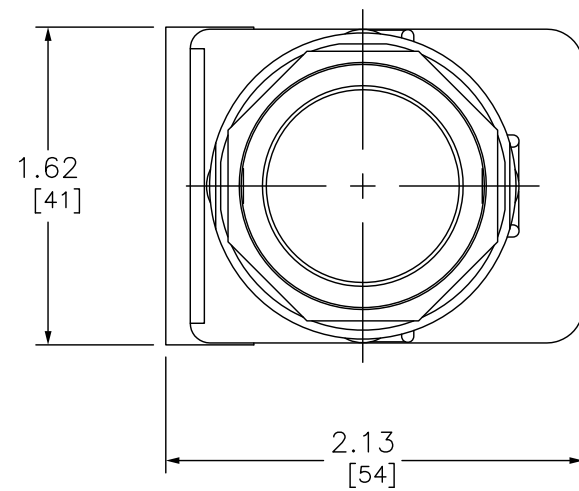

DWG# 9001K1L35LGGH13
NO.