

FRONT

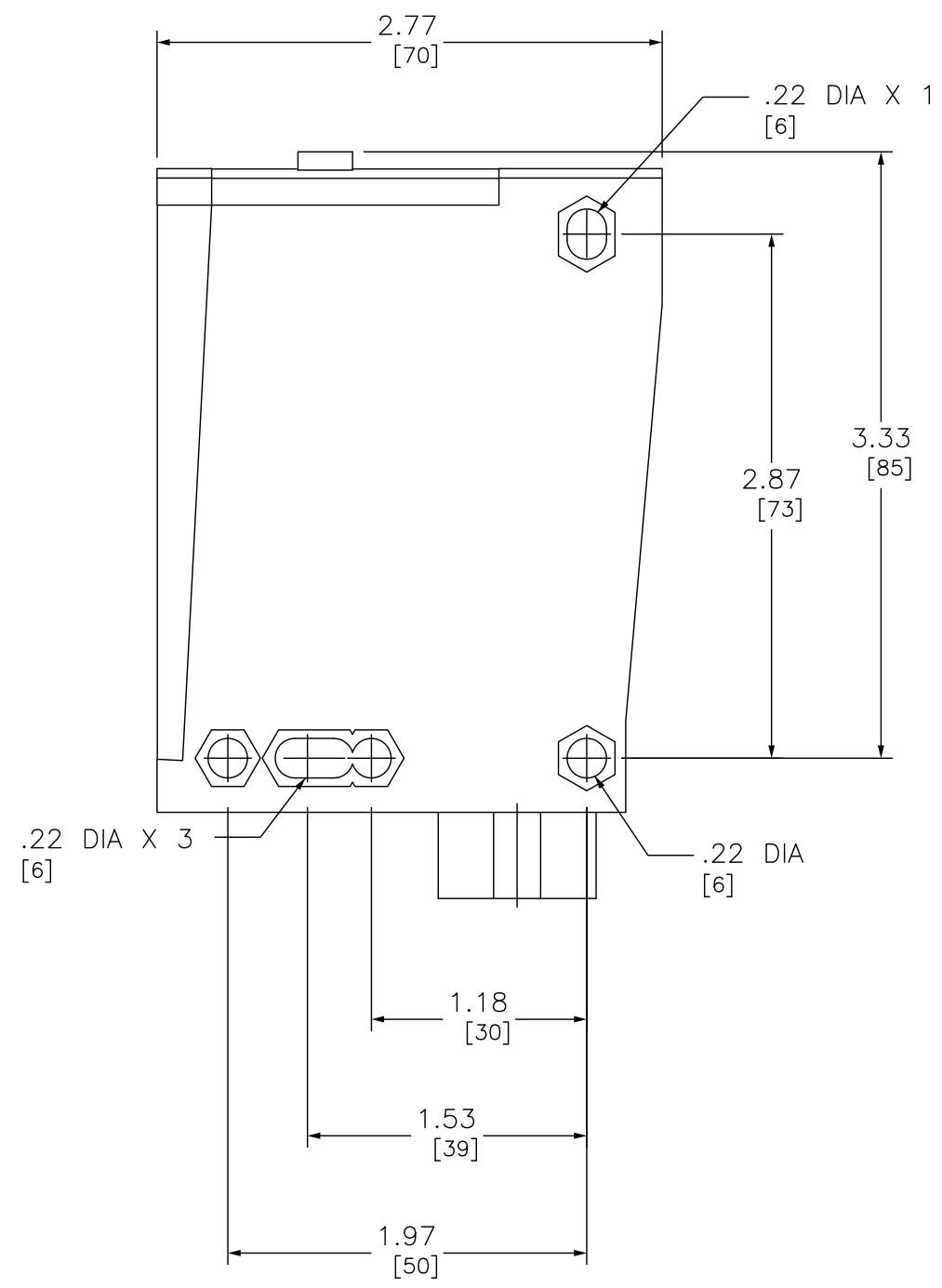

RIGHT

DUAL DIMENSIONS: INCHES
MILLIMETERS

PHOTOELECTRIC SENSOR COMPACT XUX



DWG# XUX5ARCNT16
NO.