

ZB5AK1313

Head for illuminated selector switch, Harmony XB5, grey plastic, white handle, 22mm, universal LED, 3 positions, stay put



Main

| | |
|-------------------------------|--------------------------------------|
| Range of Product | Harmony XB5 |
| Product or Component Type | Head for illuminated selector switch |
| Product Compatibility | Universal LED |
| Device short name | ZB5 |
| Bezel material | Dark grey plastic |
| Mounting diameter | 0.87 in (22 mm) |
| Head type | Standard |
| Sale per indivisible quantity | 1 |
| Shape of signaling unit head | Round |
| Type of operator | Stay put |
| Operator profile | White standard handle |
| Operator position information | 3 positions +/- 45° |

Complementary

| | |
|-----------------------------|---|
| CAD overall width | 1.14 in (29 mm) |
| CAD overall height | 1.14 in (29 mm) |
| CAD overall depth | 1.69 in (43 mm) |
| Net Weight | 0.04 lb(US) (0.016 kg) |
| Mechanical durability | 1000000 cycles |
| Station name | XALD 1...5 cut-outs XALK 2...5 cut-outs |
| Electrical composition code | M3 4 single front mounting integral LED M6 2 single front mounting integral LED and transformer M10 2 single front mounting integral LED MF1 2 single front mounting integral LED MR1 2 single rear mounting integral LED M4 4 single and double front mounting integral LED |
| Device presentation | Basic element |

Environment

| | |
|---------------------------------------|---|
| Protective treatment | TH |
| Ambient Air Temperature for Storage | -40...158 °F (-40...70 °C) |
| Ambient Air Temperature for Operation | -40...158 °F (-40...70 °C) |
| Overvoltage category | Class II IEC 60536 |
| IP degree of protection | IP66 IEC 60529 IP67 IP69 IP69K |
| NEMA degree of protection | NEMA 13 NEMA 4X |
| Resistance to high pressure washer | 1015.26 psi (7000000 Pa) 131 °F (55 °C) 0.1 m |
| IK degree of protection | IK06 IEC 50102 |

The information provided in this documentation contains general descriptions and/or technical characteristics of the performance of the products contained herein. This documentation is not intended as a substitute for and is not to be used for determining suitability or reliability of these products for specific user applications. It is the duty of any such user or integrator to perform the appropriate and complete risk analysis, evaluation and testing of the products with respect to the relevant specific application or use thereof. Neither Schneider Electric Industries SAS nor any of its affiliates or subsidiaries shall be responsible or liable for misuse of the information contained herein.

| | |
|------------------------|---|
| Standards | EN/IEC 60947-1 EN/IEC 60947-5-1 UL 508 CSA C22.2 No 14 EN/IEC 60947-5-5 JIS C8201-5-1 EN/IEC 60947-5-4 JIS C8201-1 |
| Product Certifications | CSA UL Listed DNV LROS (Lloyds register of shipping) GL BV |
| Vibration resistance | 5 gn 2...500 Hz)IEC 60068-2-6 |
| Shock resistance | 30 gn 18 ms) half sine wave acceleration IEC 60068-2-27 50 gn 11 ms) half sine wave acceleration IEC 60068-2-27 |

Ordering and shipping details

| | |
|-------------------|-------------------------------------|
| Category | 22467-PUSHBUTTONS,22MM(PLASTIC) NEW |
| Discount Schedule | CS2 |
| GTIN | 3389110137989 |
| Returnability | No |
| Country of origin | FR |

Packing Units

| | |
|------------------------------|------------------------|
| Unit Type of Package 1 | PCE |
| Number of Units in Package 1 | 1 |
| Package 1 Height | 1.18 in (3 cm) |
| Package 1 Width | 1.89 in (4.8 cm) |
| Package 1 Length | 1.97 in (5 cm) |
| Package 1 Weight | 0.81 oz (23 g) |
| Unit Type of Package 2 | S02 |
| Number of Units in Package 2 | 100 |
| Package 2 Height | 5.91 in (15 cm) |
| Package 2 Width | 11.81 in (30 cm) |
| Package 2 Length | 15.75 in (40 cm) |
| Package 2 Weight | 5.69 lb(US) (2.582 kg) |

Offer Sustainability

| | |
|----------------------------|---|
| Sustainable offer status | Green Premium product |
| California proposition 65 | WARNING: This product can expose you to chemicals including: Di-isodecyl phthalate (DIDP), which is known to the State of California to cause birth defects or other reproductive harm. For more information go to www.P65Warnings.ca.gov |
| REACH Regulation | REACH Declaration |
| REACH free of SVHC | Yes |
| EU RoHS Directive | Pro-active compliance (Product out of EU RoHS legal scope) EU RoHS Declaration |
| Toxic heavy metal free | Yes |
| Mercury free | Yes |
| China RoHS Regulation | China RoHS Declaration |
| RoHS exemption information | Yes |
| Environmental Disclosure | Product Environmental Profile |
| Circularity Profile | End Of Life Information |

Contractual warranty

| | |
|----------|-----------|
| Warranty | 18 months |
|----------|-----------|

Dimensions

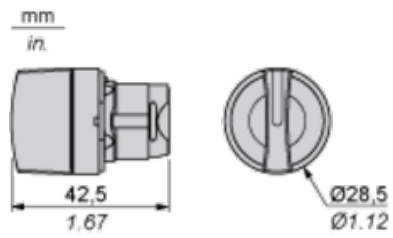

Panel Cut-out for Pushbuttons, Switches and Pilot Lights (Finished Holes, Ready for Installation)

Connection by Screw Clamp Terminals or Plug-in Connectors or on Printed Circuit Board



- (1) Diameter on finished panel or support
- (2) For selector switches and Emergency stop buttons, use of an anti-rotation plate type ZB5AZ902 is recommended.
- (3) $\varnothing 22.5$ mm recommended ($\varnothing 22.3_0^{+0.4}$) / $\varnothing 0.89$ in. recommended ($\varnothing 0.88$ in. $_0^{+0.016}$)

| Connections | a in mm | a in in. | b in mm | b in in. |
|---|---------|----------|---------|----------|
| By screw clamp terminals or plug-in connector | 40 | 1.57 | 30 | 1.18 |
| By Faston connectors | 45 | 1.77 | 32 | 1.26 |
| On printed circuit board | 30 | 1.18 | 30 | 1.18 |

Detail of Lug Recess

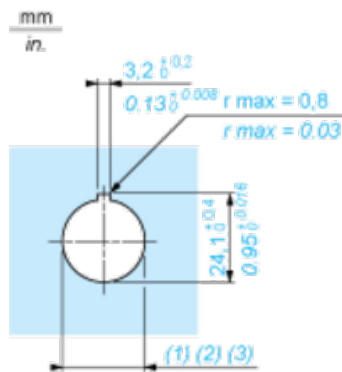

- (1) Diameter on finished panel or support
- (2) For selector switches and Emergency stop buttons, use of an anti-rotation plate type ZB5AZ902 is recommended.
- (3) $\varnothing 22.5$ mm recommended ($\varnothing 22.3_0^{+0.4}$) / $\varnothing 0.89$ in. recommended ($\varnothing 0.88$ in. $_0^{+0.016}$)

Pushbuttons, Switches and Pilot Lights for Printed Circuit Board Connection

Panel Cut-outs (Viewed from Installer's Side)



A: 30 mm min. / 1.18 in. min.

B: 40 mm min. / 1.57 in. min.

Printed Circuit Board Cut-outs (Viewed from Electrical Block Side)

Dimensions in mm



A: 30 mm min.

B: 40 mm min.

Dimensions in in.



A: 1.18 in. min.

B: 1.57 in. min.

General Tolerances of the Panel and Printed Circuit Board

The cumulative tolerance must not exceed 0.3 mm / 0.012 in.: $T1 + T2 = 0.3 \text{ mm max.}$

Installation Precautions

- Minimum thickness of circuit board: 1.6 mm / 0.06 in.
- Cut-out diameter: 22.4 mm \pm 0.1 / 0.88 in. \pm 0.004
- Orientation of body/fixing collar ZB5AZ009: $\pm 2^\circ 30'$ (excluding cut-outs marked a and b).
- Tightening torque of screws ZBZ006: 0.6 N.m (5.3 lbf.in) max.
- Allow for one ZB5AZ079 fixing collar/pillar and its fixing screws:
 - every 90 mm / 3.54 in. horizontally (X), and 120 mm / 4.72 in. vertically (Y).
 - with each selector switch head (ZB5AD•, ZB5AJ•, ZB5AG•).

The fixing centers marked a and b are diagonally opposed and must align with those marked 4 and 5.



(1) Head ZB5AD•

(2) Panel

(2) Nut

(4) Printed circuit board

Mounting of Adapter (Socket) ZBZ01•

- 1 2 elongated holes for ZBZ006 screw access
- 2 1 hole \varnothing 2.4 mm \pm 0.05 / 0.09 in. \pm 0.002 for centring adapter ZBZ01•
- 3 8 \times \varnothing 1.2 mm / 0.05 in. holes
- 4 1 hole \varnothing 2.9 mm \pm 0.05 / 0.11 in. \pm 0.002, for aligning the printed circuit board (with cut-out marked a)
- 5 1 elongated hole for aligning the printed circuit board (with cut-out marked b)
- 6 4 holes \varnothing 2.4 mm / 0.09 in. for clipping in adapter ZBZ01•

Dimensions An + 18.1 relate to the \varnothing 2.4 mm \pm 0.05 / 0.09 in. \pm 0.002 holes for centring adapter ZBZ01•.

Electrical Composition Corresponding to Code M3

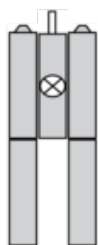

Electrical Composition Corresponding to Code M4

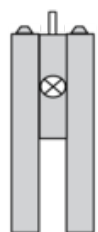

Electrical Composition Corresponding to Codes M6 and P2

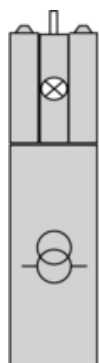

Electrical Composition Corresponding to Codes M5, M10, MF1, MR1 and MF2

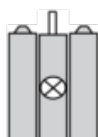

Legend

Single contact

Double contact

Light block





Possible location



Sequence of Contacts Fitted to 3-position Selector Switch Body



Position 315°



| | | | | | |
|----------|---|---|--------|---|---|
| Push | Position | Top | |  |  |
| Bottom |  |  | | | |
| Location | | Left | Right | | |
| State | | 1 | 0 | | |
| Contacts | N/O | | closed | open | |
| N/C | | open | closed | | |





Position 0°



| | | | | | |
|----------|---|---|--|--|--|
| Push | Position | Top |  |  |  |
| Bottom |  |  | | | |
| Location | | Left | Right | | |
| State | | 0 | 0 | | |
| Contacts | N/O | | open | open | |
| N/C | | closed | closed | | |

Position 45°



| | | | | | |
|----------|---|---|---|--|--|
| Push | Position | Top |  |  | |
| Bottom |  |  | | | |
| Location | | Left | Right | | |
| State | | 0 | 1 | | |
| Contacts | N/O | | open | closed | |
| N/C | | closed | open | | |