

# XCMD2102L3

Limit switch, Limit switches XC Standard, XCMD, steel roller plunger, 1NC+1 NO, snap, 3 m



## Main

Range of Product	Telemecanique Limit switches XC Standard
Series name	Standard format
Product or Component Type	Limit switch
Device short name	XCMD
Sensor design	Miniature
Body type	Fixed
Head type	Plunger head
Material	Metal
Body Material	Zamak
Head material	Zamak
Fixing Mode	By the body
Movement of operating head	Linear
Type of operator	Spring return roller plunger metal
Type of approach	Lateral approach, 2 directions
Number of poles	2
Contacts type and composition	1 NC + 1 NO
Contact operation	Snap action

## Complementary

Switch actuation	By 30° cam
Electrical connection	Removable cable connector
Cable length	9.84 ft (3 m)
Cable composition	5 x 0.75 mm <sup>2</sup>
Wire insulation material	PvR
Contacts insulation form	Zb
Positive opening	With
Positive opening minimum force	35 N
Minimum force for tripping	7 N
Maximum actuation speed	1.64 ft/s (0.5 m/s)
Contact code designation	B300, AC-15 (U <sub>e</sub> = 240 V), I <sub>e</sub> = 1.5 A EN/IEC 60947-5-1 appendix A R300, DC-13 (U <sub>e</sub> = 250 V), I <sub>e</sub> = 0.1 A EN/IEC 60947-5-1 appendix A
[Ui] rated insulation voltage	300 V 3)UL 508 400 V 3)IEC 60947-5-1 300 V 3)CSA C22.2 No 14
[Uimp] rated impulse withstand voltage	4 kV IEC 60664 4 kV IEC 60947-1
Short-circuit protection	6 A cartridge fuse gG
Electrical durability	5000000 Cycles, DC-13, 120 V, 1 W 60 cyc/mn 0.5 IEC 60947-5-1 appendix C 5000000 Cycles, DC-13, 24 V, 3 W 60 cyc/mn 0.5 IEC 60947-5-1 appendix C 5000000 cycles, DC-13, 48 V, 2 W 60 cyc/mn 0.5 IEC 60947-5-1 appendix C
Mechanical durability	10000000 cycles
Width	1.18 in (30 mm)
Height	1.97 in (50 mm)
Depth	0.63 in (16 mm)

The information provided in this documentation contains general descriptions and/or technical characteristics of the performance of the products contained herein. This documentation is not intended as a substitute for and is not to be used for determining suitability or reliability of these products for specific user applications. It is the duty of any such user or integrator to perform the appropriate and complete risk analysis, evaluation and testing of the products with respect to the relevant specific application or use thereof. Neither Schneider Electric Industries SAS nor any of its affiliates or subsidiaries shall be responsible or liable for misuse of the information contained herein.

## Environment

Shock resistance	25 gn 18 ms IEC 60068-2-27
Vibration resistance	5 gn 10...500 Hz)IEC 60068-2-6
IP degree of protection	IP66 conforming to IEC 60529 IP67 conforming to IEC 60529 IP68 conforming to IEC 60529
IK degree of protection	IK06 EN 62262
Overvoltage category	Class I
Ambient Air Temperature for Operation	-13...158 °F (-25...70 °C)
Product Certifications	UL CSA
Standards	EN 60947-5-1 IEC 60947-5-1 CSA C22.2 No 14 UL 508



## Ordering and shipping details

Category	22413-LIMIT SWITCH, IEC, MINIATURE
Discount Schedule	T
GTIN	3389110301113
Returnability	Yes
Country of origin	ID

## Packing Units

Unit Type of Package 1	PCE
Number of Units in Package 1	1
Package 1 Height	0.98 in (2.5 cm)
Package 1 Width	7.87 in (20.0 cm)
Package 1 Length	7.87 in (20.0 cm)
Package 1 Weight	11.78 oz (334.0 g)
Unit Type of Package 2	PAL
Number of Units in Package 2	240
Package 2 Height	23.62 in (60.0 cm)
Package 2 Width	31.50 in (80.0 cm)
Package 2 Length	94.49 in (240.0 cm)
Package 2 Weight	180.96 lb(US) (82.08 kg)
Unit Type of Package 3	S03
Number of Units in Package 3	30
Package 3 Height	11.81 in (30.0 cm)
Package 3 Width	11.81 in (30.0 cm)
Package 3 Length	15.75 in (40.0 cm)
Package 3 Weight	24.37 lb(US) (11.053 kg)

## Offer Sustainability

Sustainable offer status	Green Premium product
California proposition 65	WARNING: This product can expose you to chemicals including: Diisononyl phthalate (DINP), which is known to the State of California to cause cancer, and Di-isodecyl phthalate (DIDP), which is known to the State of California to cause birth defects or other reproductive harm. For more information go to <a href="http://www.P65Warnings.ca.gov">www.P65Warnings.ca.gov</a>
REACH Regulation	 <a href="#">REACH Declaration</a>
EU RoHS Directive	Pro-active compliance (Product out of EU RoHS legal scope)  <a href="#">EU RoHS Declaration</a>
Mercury free	Yes
RoHS exemption information	 Yes

---

Environmental Disclosure	<a href="#">Product Environmental Profile</a>
Circularity Profile	<a href="#">End Of Life Information</a>

---

### Contractual warranty

---

Warranty	18 months
----------	-----------

---

Dimensions

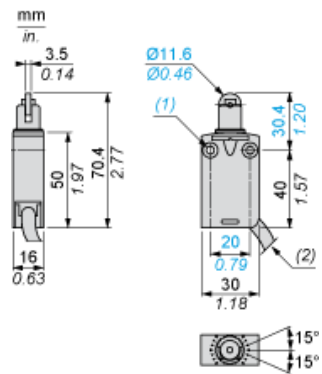

- (1) 2 fixing holes  $\text{Ø} 4.2$  mm, counterbored  $\text{Ø} 8$  mm by 4 mm deep.
- (2) External diameter of cable 7.5 mm.

---

## Mounting

---

### Sweep of Connecting Cable

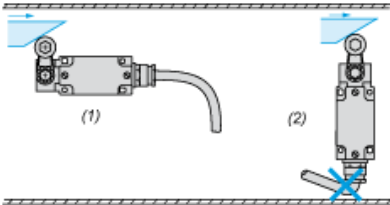

- (1) Recommended
- (2) To be avoided

---

## Setting-up

---

### Plunger or Multi-directional Heads

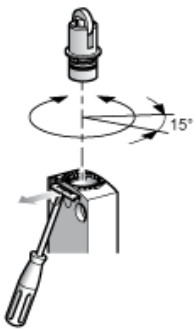

---

## Wiring Diagram

---

### 2-pole NC + NO Snap Action

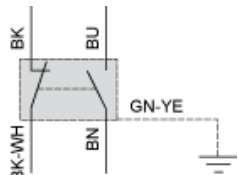

(BK) Black  
(BK- Black White  
WH)  
(BU) Blue  
(BN) Brown  
(GN- Green Yellow  
YE)

Characteristics of Actuation

Switch Actuation by 30° Cam

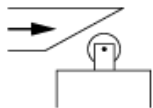

Functional Diagram

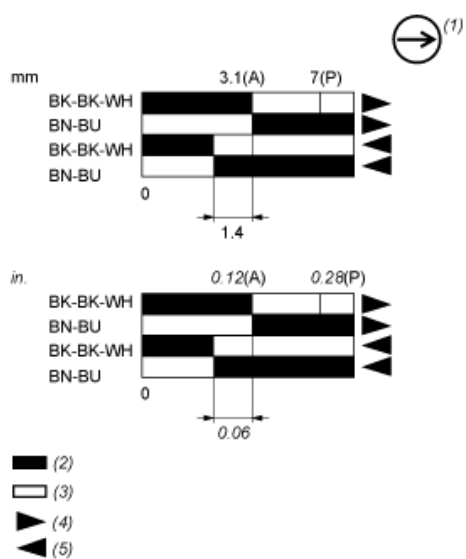

- (P) Positive opening point
- (A) Cam displacement
- (1) NC contact with positive opening operation
- (2) Closed
- (3) Open
- (4) Tripping
- (5) Resetting
- (BK) Black
- (BK- Black White
- WH)
- (BU) Blue
- (BN) Brown