

## Grounding and Bonding Practices When Installing Variable Frequency Drives

Retain for future use.

### Introduction

Variable frequency drives (VFDs) have several unique wiring characteristics that must be considered in their installation to minimize electrical interference with drive control signal wiring, communication networks, PLCs, or other equipment. Following the grounding and shielding practices discussed in this paper will help improve control and network signal integrity, reduce signal errors, and increase operational performance.

VFDs have unique characteristics that must be considered in their installation. VFDs control the voltage and current in a motor by rapidly switching the voltage on and off. The drive output is a pulse width modulated voltage waveform with a very fast rise time that can easily couple in to other equipment, either by conducted or radiated emissions. Proper grounding and shielding can reduce this effect.

Leakage currents from the PWM waveform may affect ground fault protective relays. How much they are affected depends on the type of EMC filter used, whether or not this filter is grounded, and also by how the power system is grounded.

Drive control circuits are not internally referenced to ground. We will show how and where to ground them for maximum benefit.

By properly grounding the drive we can help reduce the EMI from the drive operation, reduce ground fault tripping, and obtain the best control signal integrity.

### Definitions

**Electromagnetic interference (EMI).** This is an unwanted signal that can disturb monitoring, control, or communication signals. EMI can be radiated through the air or conducted over the control, network, or power wiring. EMI should be eliminated or reduced as much as possible.

**Electromagnetic compatibility (EMC).** This is a term used to describe methods or equipment that can reduce electromagnetic interference. An example is the EMC filter (Figure 1) which connects to the input of the VFD.

**Figure 1: EMC Filter**



**Pulse Width Modulation (PWM).** Since the DC bus voltage is not adjustable, the varying output voltage of a VFD is created by varying the width of the output pulses. For a 460 V drive, the motor pulses rise from 0 to 650 Vdc in less than a microsecond. This high dV/dt can cause noise currents to be coupled into other nearby conductors. See Figure 2. The pulse frequency is constant, 4 kHz for example, and the pulse width (also called duty cycle) controls the average effective voltage.

**Figure 2: Pulse Width Modulation**

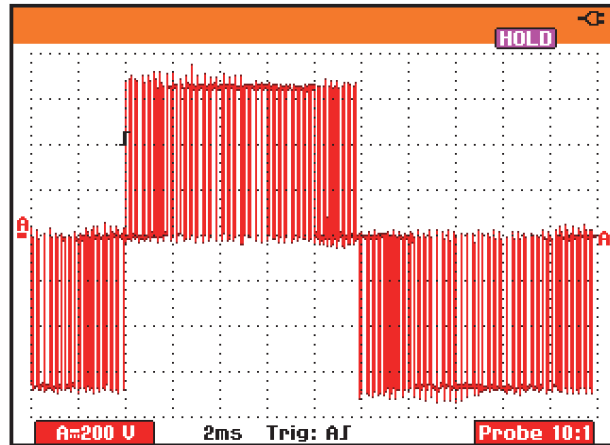

## Fundamental Principles

### Principle 1

Electricity always travels in a closed loop. When troubleshooting electrical noise issues, look for the path back to the source.

Using a current probe with an oscilloscope can be helpful in diagnosing and correcting grounding issues. By detecting the noise currents and understanding the path, it is easier to know how to do the ground wiring.

### Principle 2

There is always some capacitance between any two conductors.

**Figure 3: Capacitance**

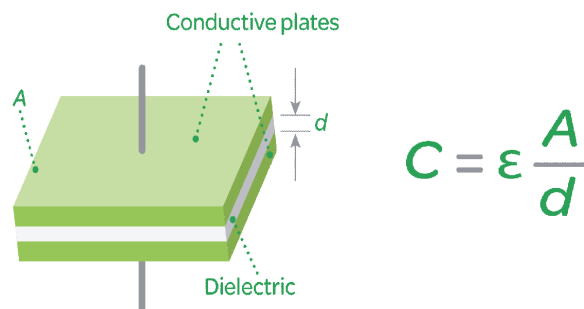

### Principle 3

The current in a capacitor depends on the rate of change of the voltage.

**Figure 4: Capacitor Current**

$$I = C \frac{dV}{dt}$$

The PWM voltage pulses can result in currents spikes in the ground wires. As an example, capacitively coupled current spikes from a square wave are shown in Figure 5.

**Figure 5: Noise Currents**

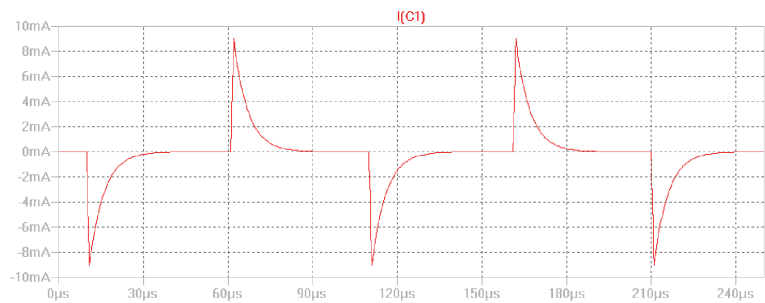

## Three Areas of Grounding

- VFD input side grounding
- VFD output side grounding
- VFD controls and communications grounding

The drive must be grounded to the incoming power for safety and for noise reduction. The motor should also be grounded. How that is accomplished can greatly affect the amount of electrical noise in the system. Since the drives have analog and digital inputs and outputs (I/O) for control systems, as well as communications such as Modbus or Ethernet, proper grounding of these cables is also important.

### VFD Input Side Grounding

In the US, all installations use one of the following methods of input side connections:

- Wye solidly grounded
- High resistance grounded
- Corner grounded delta
- Corner grounded open delta
- High leg delta
- Delta ungrounded

#### Wye Solidly Grounded

This is the most common and preferred method of input side grounding. It gives a balanced voltage to ground and it provides a path for ground currents. Incoming transients have a path to ground, so they do not get to the drive. Noise currents coupled to ground from the motor can use the ground to get back to the drive. See "VFD Output Side Grounding" on page 6. This noise then does not go further upstream.

Slash rated overcurrent protective devices, with ratings such as 480Y/277, can be used on solidly grounded Wye systems. They cannot be used on

any of the other connection systems because one or more of the voltages will exceed the lower number in the slash rating. The EMC neutral switch on the drive can be closed when using a solidly grounded WYE system. It should be opened when using one of the other connection systems.

**Figure 6: Wye Solidly Grounded**

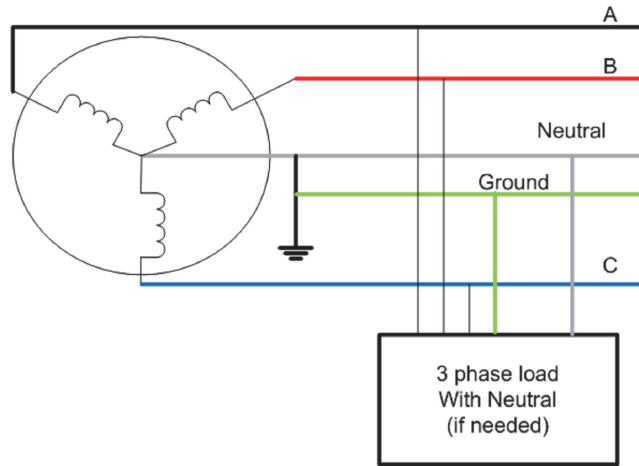

High Resistance Grounded (HRG) Systems

This configuration has a resistor from the transformer wye neutral to ground. It limits any fault current if there is a short to ground. Because the fault current is low, the circuit breaker will not open. A ground fault relay is used to detect if there is a ground fault and this relay can be used to provide a warning or to trip the circuit breaker.

Corner Grounded Delta

In this configuration, one of the phases of the delta connected secondary is grounded (usually B phase) to create a Neutral. Although most drives can work with this configuration, there is a higher line-to-ground voltage for the A and C phases, and therefore the EMC filter ground must be disconnected. Also, the DC bus levels fluctuate and can produce drive ground faults if the cable runs to the motor are long.

**Figure 7: Corner Grounded Delta**

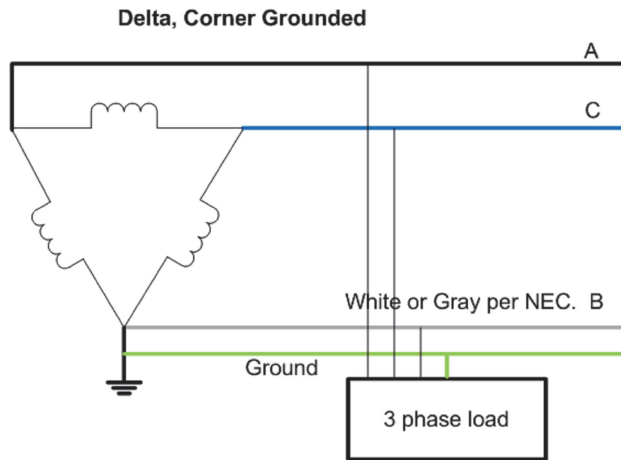

Corner Grounded Open Delta

Similar to the corner grounded delta, this configuration has the B phase grounded. However, the transformer winding from A to C is missing. This phase is created by the vector sum of A to B plus B to C. For running three-phase motors directly, it can work satisfactorily. But since drives have a rectifier front end, they can act as though they are on single-phase power. The voltages can become very unbalanced and the drive may overheat. Adding a line reactor can help balance the currents. A better solution is to add a delta wye drive isolation transformer to balance the voltages and derive a neutral for balanced drive input voltages.

**Figure 8: Corner Grounded Open Delta**

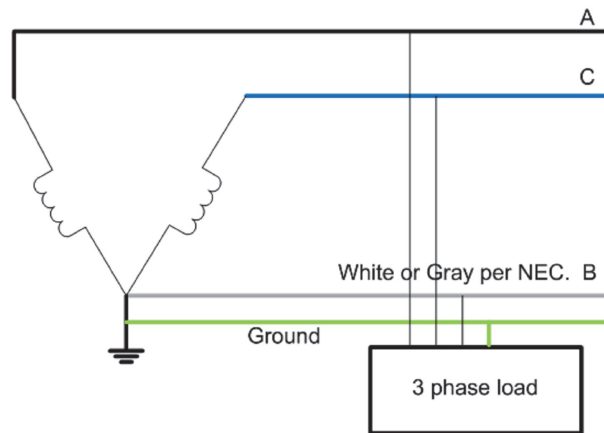

High Leg Delta

In this delta configuration, one of the windings has a grounded center tap. Usually used only for 240 V systems, this gives two 120 V lines to ground (A to ground and C to ground) as well as 240 V (A to C), similar to the single phase power in house. The B phase is higher with respect to ground, 208 V, and therefore the name high leg delta.

Line-to-ground voltages: A = 120, B = 208, C = 120.  
Line-to-line voltages: A to B = 240, B to C = 240, C to A = 240.

**Figure 9: High Leg Delta**

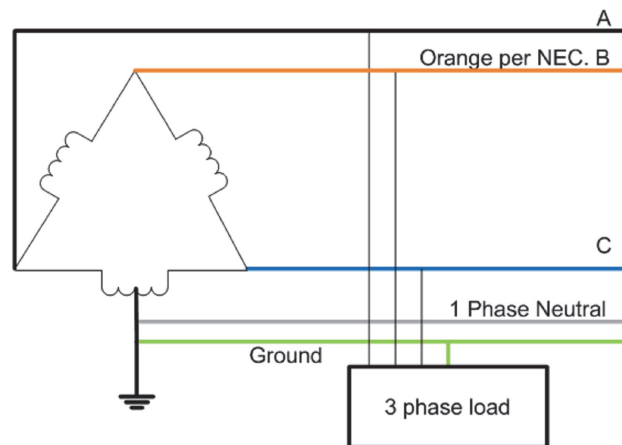

With this configuration, a building could have single-phase power for the lights and equipment and three-phase power for the pumps and fans. This is

Delta ungrounded

usually seen in farms and applications where the amount of power needed is low. The EMC filter must be disconnected in this configuration.

The delta secondary in this system is not grounded at all, but is left floating with respect to ground. The actual voltage to ground is a result of stray capacitances. If the capacitances are balanced, then the voltage may appear to be balanced with respect to ground; however, any transients can upset this balance and cause much higher voltages with respect to ground. In this system, the EMC filter must be disconnected from ground. There may be high levels of electrical noise which can interfere with the analog and logic signals and the communication protocols.

**Figure 10: Delta Ungrounded**

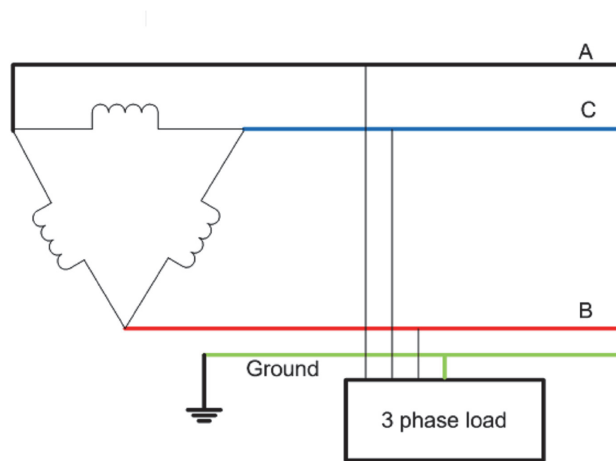

VFD Output Side Grounding

**Figure 11: Noise Current Path in a Drive System**

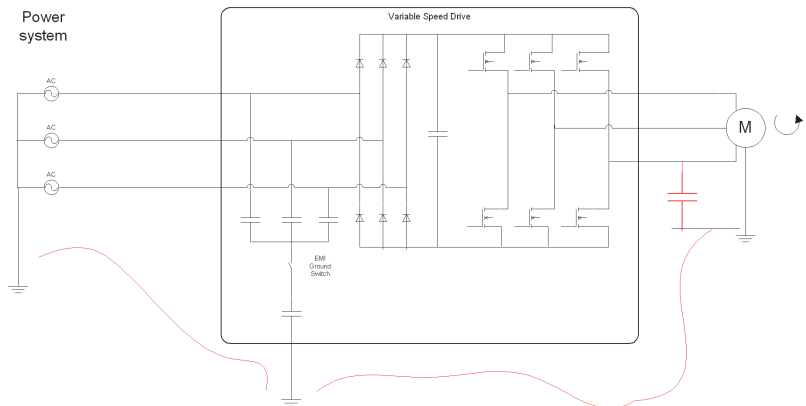

The capacitively coupled noise currents from the motor and the motor cable get coupled to ground and want to get back to the drive's DC bus. This is the source of the PWM pulses, so the currents complete a loop back to the DC bus.

The EMC filter, if connected to ground, provides a path back into the drive. If the EMC filter ground switch is open, then the current has to go back to the transformer neutral, then on the power leads, and then into the drive.

Rule 1

Dedicate a ground wire from the motor directly to the VFD.

**Figure 12: Dedicated Ground Wires from Motor to Drive**

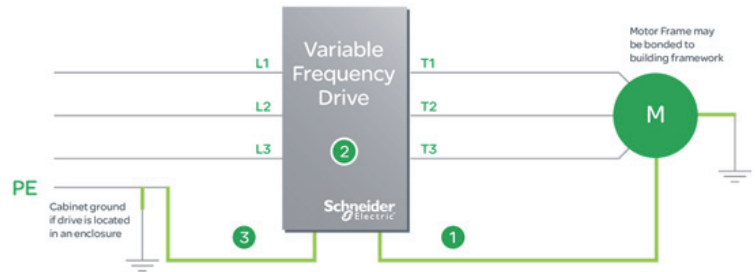
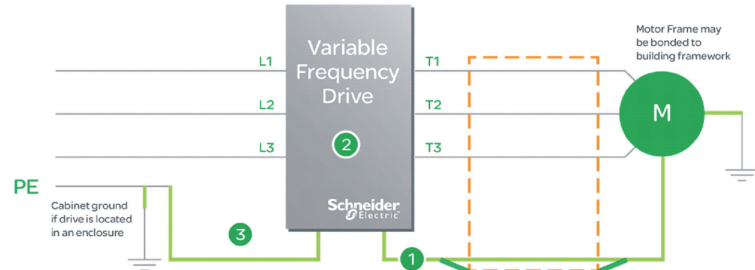

Figure 12 illustrates how to properly run the ground wires to the drive. There must be a ground wire (1) that comes from the motor, along with the motor power leads, directly back to the drive (2). Any noise that is coupled from the motor winding to the motor housing gets brought by this ground wire back to the drive, through the drive's internally grounded EMC filter, and back to the DC bus. The incoming power ground (3) also has a wire from the drive to the power system ground. This ground wire does not need to carry the noise currents if the output ground wire is in place.

Rule 2

When using shielded cable between the VFD and motor, connect the cable shield at both ends.

**Figure 13: Connect the VFD Motor Cable Shield at Both Ends**



Results of Properly Grounding a VFD

**Figure 14: Input Ground (Left) and Motor Ground (Right)**

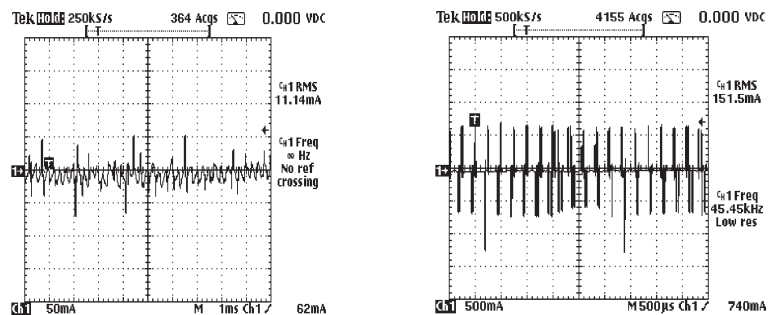
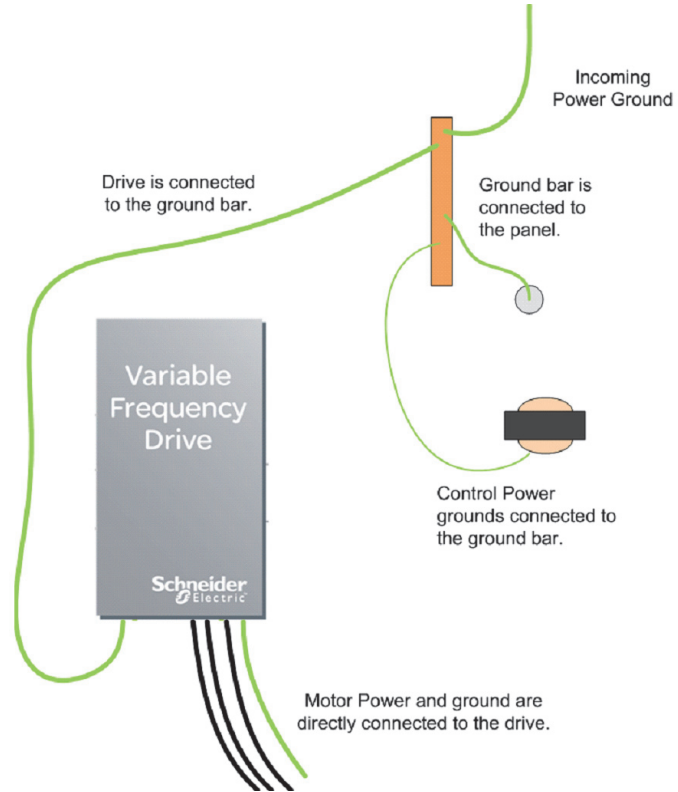

Figure 14 shows the input ground (left) and the motor ground (right). The input ground wire carries far less noise current than the motor ground wire. Note that the scale factor for the motor ground graph is 10 times larger than that of the input ground graph. If the EMC filter were disconnected from ground, then these two currents would be the same.

Properly Grounding a VFD on a Panel

The motor power and the motor ground wire are connected directly to the drive. This helps ensure that the noise currents do not have to go through other wires on the panel. The incoming power ground wire comes to a ground bar and then on to the drive. The ground bar is connected to the panel at a location where the paint has been removed. Removing the paint helps ensure a good electrical connection. Other control power transformers, power supplies, PLCs, and such are also connected to the ground bar.

**Figure 15: Properly Grounding a VFD on a Panel**



Optimal EMC Grounding

Most open style drives come with an EMC grounding plate (1) attached to the bottom of the drive.

**Figure 16: EMC Grounding**

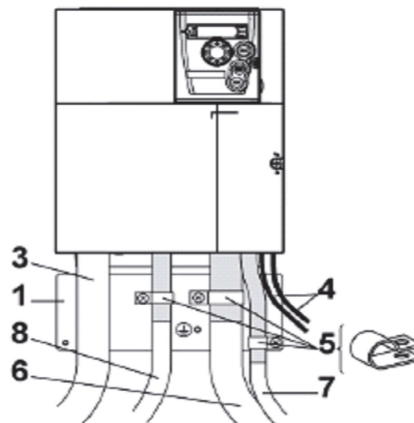



Motor cable (6) is a shielded VFD cable with three wires plus the ground. The motor ground is directly connected to the drive ground terminal. The shield is exposed and grounded by the clamps (5).

The DB resistor cable (8) and control cable (7) should also be shielded and grounded to this plate. The input power (3) and relay control wires (4) do not need to be shielded.

## More Fundamental Principles

### Principle 4

Every wire has some inductance and therefore impedance.

### Principle 5

The voltage across an impedance depends on the current through it (Ohm's Law:  $V = I \times R$ ).

### Principle 6

If a circuit has multiple loops and they share an impedance, the voltage in one loop will be affected by the current in the other loop. This is called shared impedance coupling.

**Figure 17: Shared Impedance Coupling**

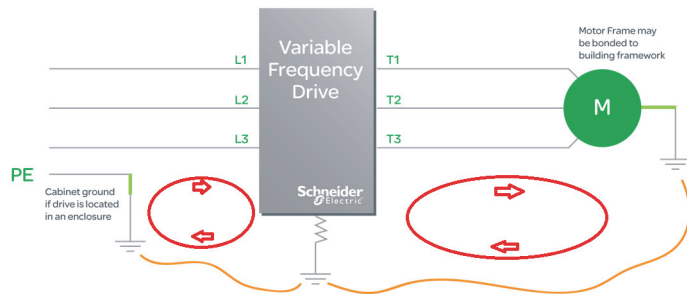

For example, Figure 17 illustrates a drive in a cabinet with a 3 ft wire connecting the drive to a ground bar at the bottom of the cabinet.

This 3 ft wire will have an inductance of more than 1  $\mu\text{H}$ , and at 1 MHz that is more than 6 ohms of impedance.

The current spikes of 1 A that we saw in an earlier graph would develop a voltage of 6 V across this wire.

These 6 V spikes would be added to the signal of any analog inputs or outputs.

## VFD Control and Communication Grounding

### Common Reference

The logic inputs and outputs (I/O), analog I/O, and serial communications are in a circuit that shares a common reference. This common is not grounded inside the drive. It is intended to be grounded at the system controller or PLC. It must not be left floating, especially if shielded cable is used.

### Switch Mode Power Supplies

In order to derive the voltages needed for the electronics and the I/O, such as the 24 V for the logic inputs and the 10 V for the speed potentiometer, there is a switch mode power supply. This power supply has a transistor that switches the DC bus voltage at 50 kHz to 100 kHz and drives a transformer

to create the 5 V, 10 V, and 24 V needed. Although there is filtering for the switch mode power supply, if the drive is not properly grounded, 50–100 kHz noise could appear on the control signals.

**Rule 3**

Ground the common of the control circuits at the system controller or PLC, rather than at the drive.

**Rule 4**

Connect shields to the common reference.

**Figure 18: Rule 3 and Rule 4**

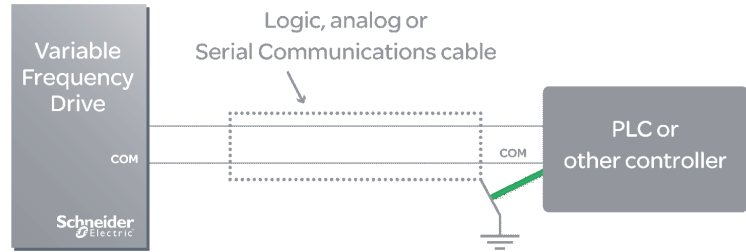

In this example, the shield and common are tied to ground at the PLC. With the common and the shield at the same voltage, there will be no current flow between them, even if there is a significant amount of capacitance between them.

Any noise currents in the shield go to the reference point at the PLC and do not add to any differential voltages on the signal wires. If there are any switch mode power supply currents capacitively coupled to the control circuits in the drive, the common wire will carry them to ground and back to the drive, not affecting the control signals.

**Figure 19: Improper Grounding of Shielded Cable**

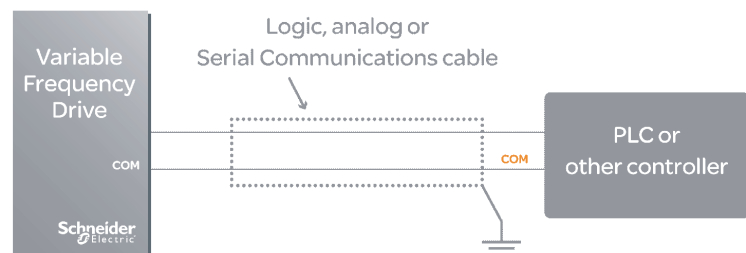

The example in Figure 19 shows a common mistake. The shield is grounded, but the control circuits of the wires inside the shield are left floating. This causes electrical noise issues.

The stray capacitances within the drive and controller will cause the wires in the shield to be at some voltages other than ground. Because the wires and the shield are at different voltages, the capacitance in the cable will cause noise currents to flow, showing up as noise voltages between the wires and with respect to ground. Shields must be connected to the common reference of the wires they contain, and the common must be grounded at one point in the installation.

**Rule 5**

Ground the shield at both ends.

**Rule 6**

Use a 0.01 μF (typical value) capacitor at one end of long cables.

**Figure 20: Rule 5 and Rule 6**

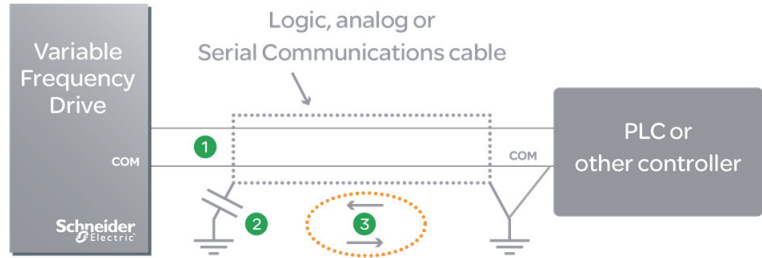

For the best in high frequency rejection, it may be desirable to ground the other end of the shield at point 1 for bypassing high frequency noise to ground. For long cable runs where the grounds may be at different potentials, it is recommended to ground the other end (1) through a capacitor (2) to block the low frequency (60 Hz) currents that could flow through a ground loop (3). Without the capacitor, low frequency currents can flow through the shield and couple noise into the signal wires inside the shield.

**Rule 7**

Maintain good separation of wiring.

**Figure 21: Rule 7**

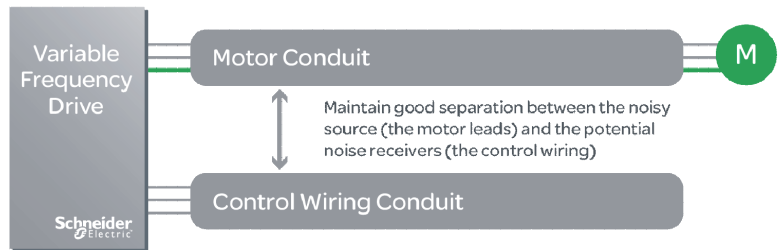

It is necessary to keep the noise sources (the motor leads) separated from the potential noise receivers (the control or communication wiring). This can be accomplished by distance and shielding. Use separate conduits for the motor and the control wiring. Never run control wiring in the same conduit as the motor leads.

Metal conduit that is grounded can provide some electrostatic shielding. Steel conduit can also shield the wires from magnetic fields, further improving the reliability.

**Principles Summary**

1. Electricity always travels in a closed loop.
2. There is always some capacitance between any two conductors.
3. The current in a capacitor depends on the rate of change of the voltage.  
 $I = C \, dV/dt$ .
4. Every wire has inductance and therefore impedance.

5. The voltage across an impedance depends on the current through it.  
Ohms law:  $V = I \times R$ .
6. If a circuit has multiple loops and they share an impedance, the voltage in one loop will be affected by the current in the other loop.

## Rules Summary

1. Dedicate a ground wire from the motor directly to the VFD.
2. When using shielded cable between the VFD and motor, connect the cable shield at both ends.
3. Ground the common of the control circuits at the system controller or PLC.
4. Connect shields to the common reference.
5. Ground the shield at both ends if there is not a risk that there will be stray ground currents.
6. Use a capacitor to ground the shield at one end of long cables to eliminate stray ground loop currents. Typical capacitor value is 0.01  $\mu\text{F}$ .
7. Maintain good separation of wiring.

## Conclusion

By understanding how electric noise currents can flow in a system, noise can be reduced or channeled in a way that can greatly reduce the effects that the noise can produce. The PWM output of VFDs with its high  $dV/dt$  can be easily coupled into other parts of the circuit where it can cause electrical interference in control wiring and communication cables. By using the techniques shown in this paper, we can reduce the noise and provide reliable control of motor loads.

## For More Information

For more information on variable frequency drives see:

- 8800DB0801, *The Effects of Available Short Circuit Current on AC Drives*
- 8800DB1203, *Variable Frequency Drives and Short-Circuit Current Ratings*
- CPTG003, *Control Panel Technical Guide-How to protect a machine from malfunctions due to electromagnetic disturbance.*

For more information on Grounding see:

- Electrical Installation Guide 2015 from Schneider Electric
- National Electric Code® NFPA® 70
- IEEE Green Book 142-1991, "Recommended Practice for Grounding of Industrial and Commercial Power Systems"
- IEEE Emerald Book 1100-1999 "Recommended Practice for Powering and Grounding Sensitive Electronic Equipment"
- IEC 60364 "Low-Voltage Electrical Installation"

**Schneider Electric USA, Inc.**  
800 Federal Street  
Andover, MA 01810 USA  
888-778-2733  
www.schneider-electric.us

Electrical equipment should be installed, operated, serviced, and maintained only by qualified personnel. No responsibility is assumed by Schneider Electric for any consequences arising out of the use of this material.

Schneider Electric and Square D are trademarks owned by Schneider Electric Industries SAS or its affiliated companies. All other trademarks are the property of their respective owners.