



Main

Range of Product	Harmony Control Relays
Product or Component Type	Speed control relay
Relay Type	Speed control relays
Relay name	RM35S
Relay monitored parameters	Overspeed Underspeed
Time delay range	0.6...60 s adjustable on energisation (0...10 % of the full scale value)
Switching capacity in VA	1250 VA
Minimum switching current	10 mA 5 V DC
[Us] rated supply voltage	24...240 V AC/DC
Maximum power consumption in VA	5 VA AC
Measurement range	0.05...0.5 s 0.5...5 min 1...10 min 1...10 s 0.5...5 s 0.1...1 s 0.1...1 min
Utilisation category	AC-12 IEC 60947-5-1 AC-13 IEC 60947-5-1 AC-14 IEC 60947-5-1 AC-15 IEC 60947-5-1 DC-12 IEC 60947-5-1 DC-13 IEC 60947-5-1 DC-14 IEC 60947-5-1

Complementary

Rest time in memory mode	50 Ms contact S2 in memory mode on time delay 1 s supply Un in memory mode on time delay
Maximum switching voltage	250 V AC/DC
Supply voltage limits	20.4...264 V AC/DC
Maximum power consumption in W	3 W DC
Width	1.38 in (35 mm)
Output contacts	1 C/O
Contacts material	Cadmium free
Nominal output current	5 A
Delay at power up	0.05 s
Hysteresis	5 % threshold
Measurement accuracy	+/- 10 % of the full scale value
Repeat accuracy	+/- 0.5 % input and measurement circuit +/- 0.5 % time delay
Measurement error	+/- 0.1 %/°C with temperature variation < +/- 1 % over the whole range with voltage variation
Input frequency	0.0017...20 Hz
Response time	15 ms max (on crossing the threshold)
Polarity	Reversible polarity on DC supply
Threshold setting	10...100 %

Supply voltage for sensor	11.5...12.5 V
Maximum supply current for sensors	40 MA < 24 V AC 77 °F (25 °C) 40 MA < 24 V DC 77 °F (25 °C) 50 MA 24...240 V AC 50 mA 24...240 V DC
Impulse duration	>= 5 ms high state >= 5 ms low state
Input compatibility	3-wire sensor (E1) PNP or NPN, 12 V, 50 mA NAMUR sensor (E2), 12 V, 1.5 kOhm Voltage input (E1), 0...30 V, 9.5 kOhm >= 4.5 V <= 1 V Volt-free contact input (E1), 12 V, 9.5 kOhm
Marking	CE : EMC 89/336/EEC CE : 73/23/EEC
Overvoltage category	III IEC 60664-1
Insulation resistance	> 500 MOhm 500 V DC between supply and relay output IEC 60255-5 > 500 MOhm 500 V DC between measurement and relay output IEC 60664-1 > 1 MOhm 500 V DC between supply and measurement IEC 60255-5 > 500 MOhm 500 V DC between supply and relay output IEC 60664-1 > 500 MOhm 500 V DC between measurement and relay output IEC 60255-5 > 1 MOhm 500 V DC between supply and measurement IEC 60664-1
[Ui] rated insulation voltage	250 V IEC 60664-1
Operating voltage tolerance	- 15 % + 10 % Un
Supply frequency	50/60 Hz +/- 10 %
Operating position	Any position without derating
Connections - terminals	Screw terminals, 1 x 0.5...1 x 4 mm ² AWG 20...AWG 11) solid without cable end Screw terminals, 2 x 0.5...2 x 2.5 mm ² AWG 20...AWG 14) solid without cable end Screw terminals, 1 x 0.2...1 x 2.5 mm ² AWG 24...AWG 12) flexible with cable end Screw terminals, 2 x 0.2...2 x 1.5 mm ² AWG 24...AWG 16) flexible with cable end
Tightening torque	5.31...8.85 lbf.in (0.6...1 N.m) IEC 60947-1
Housing material	Self-extinguishing plastic
Status LED	1 LED Green power ON 1 LED Yellow inhibit 1 LED Yellow relay (R)
Mounting support	35 mm symmetrical DIN rail conforming to EN/IEC 60715
Electrical durability	100000 cycles
Mechanical durability	30000000 cycles
Operating rate	<= 360 operations/hour full load

Environment

Immunity to microbreaks	50 ms
Electromagnetic compatibility	Emission standard for industrial environments EN/IEC 61000-6-4 Emission standard for residential, commercial and light-industrial environments EN/IEC 61000-6-3 Immunity for industrial environments NF EN/IEC 61000-6-2
Standards	NF EN 60255-6 IEC 60255-6
Product Certifications	C-tick GOST UL GL CSA
Ambient Air Temperature for Storage	-40...158 °F (-40...70 °C)
Ambient Air Temperature for Operation	-4...122 °F (-20...50 °C)
Relative humidity	95 % 131 °F (55 °C) IEC 60068-2-30
Vibration resistance	0.35 mm 5...57.6 Hz)IEC 60068-2-6/IEC 60255-21-1 1 gn 57.6...150 Hz)IEC 60068-2-6/IEC 60255-21-1
Shock resistance	15 gn 11 ms IEC 60255-21-1
IP degree of protection	IP20 IEC 60529 terminals) IP30 IEC 60529 casing)
Pollution degree	3 IEC 60664-1
Dielectric test voltage	2 kV AC 50 Hz
Non-dissipating shock wave	4 kV

Ordering and shipping details

Category	22380-RELAYS-MEASUREMENT (RM17-RM35)
Discount Schedule	CP2
GTIN	3389119405256
Returnability	Yes
Country of origin	ID

Packing Units

Unit Type of Package 1	PCE
Number of Units in Package 1	1
Package 1 Height	1.73 in (4.4 cm)
Package 1 Width	2.91 in (7.4 cm)
Package 1 Length	3.70 in (9.4 cm)
Package 1 Weight	4.59 oz (130.0 g)
Unit Type of Package 2	S03
Number of Units in Package 2	48
Package 2 Height	11.81 in (30.0 cm)
Package 2 Width	11.81 in (30.0 cm)
Package 2 Length	15.75 in (40.0 cm)
Package 2 Weight	15.83 lb(US) (7.181 kg)

Offer Sustainability

Sustainable offer status	Green Premium product
California proposition 65	WARNING: This product can expose you to chemicals including: Lead and lead compounds, which is known to the State of California to cause cancer and birth defects or other reproductive harm. For more information go to www.P65Warnings.ca.gov
REACH Regulation	REACH Declaration
EU RoHS Directive	Pro-active compliance (Product out of EU RoHS legal scope) EU RoHS Declaration
Mercury free	Yes
China RoHS Regulation	China RoHS Declaration
RoHS exemption information	Yes
Environmental Disclosure	Product Environmental Profile
Circularity Profile	End Of Life Information
WEEE	The product must be disposed on European Union markets following specific waste collection and never end up in rubbish bins.

Contractual warranty

Warranty	18 months
----------	-----------

Speed Control Relays

Dimensions and Mounting

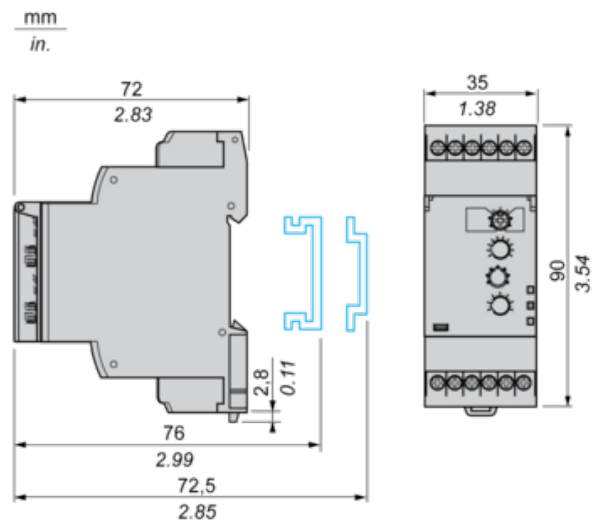

Speed Control Relays

Wiring Diagrams

Contact input

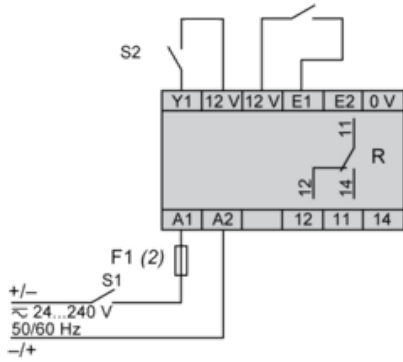

(2) A quick-blow fuse or circuit-breaker.

S2 Inhibit - Reset

Namur proximity sensor input

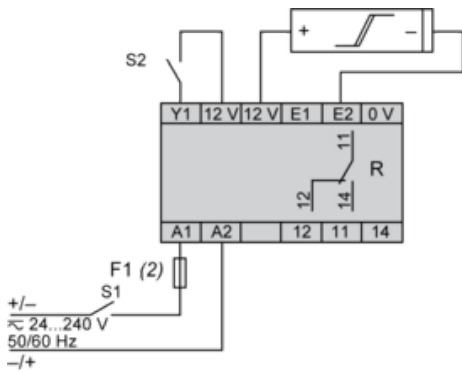

(2) A quick-blow fuse or circuit-breaker.

S2 Inhibit - Reset

NPN/PNP sensor input

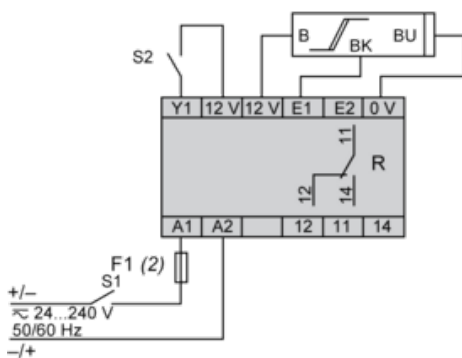

(2) A quick-blow fuse or circuit-breaker.

S2 Inhibit - Reset

0-30 V voltage input

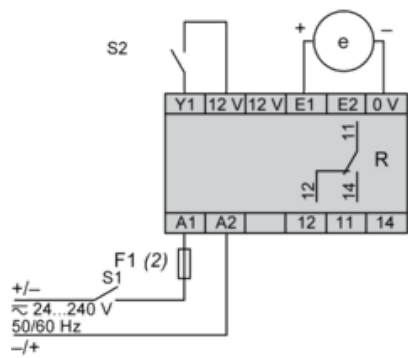

(2) A quick-blow fuse or circuit-breaker.

S2 Inhibit - Reset

Function Diagrams

Underspeed Control

Without memory ("No Memory" mode)

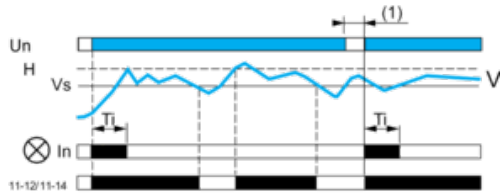

With memory ("Memory" mode)

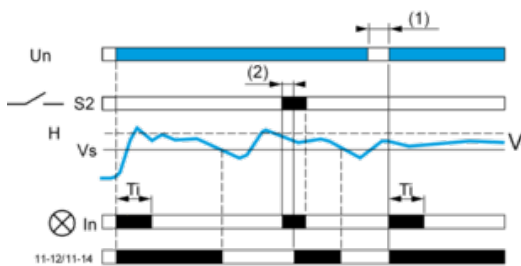

With inhibition by S2 ("Inhib./S2" mode)

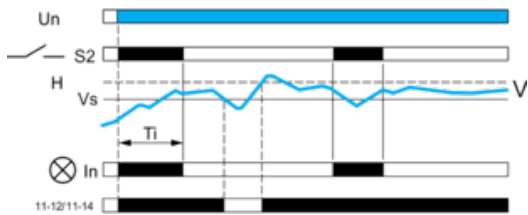

Overspeed Control

Without memory ("No Memory" mode)

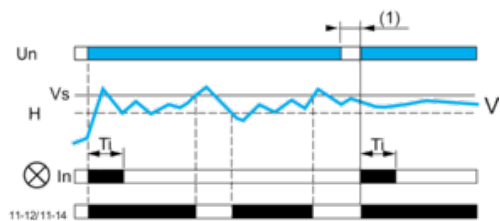

With memory ("Memory" mode)

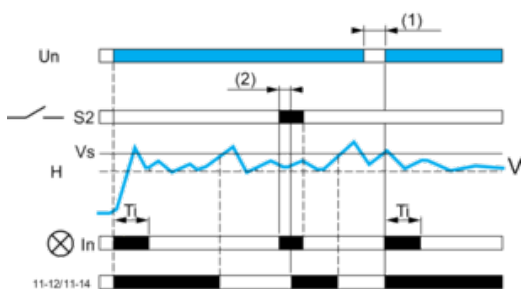

Legend

- T_i Starting inhibition time delay
- U_n Supply voltage
- V Monitored speed
- H Hysteresis

Vs Overspeed threshold

S2 Inhibition external contact

In LED indicating the inhibition status

(1) Power break to reset the output relay

(2) S2 contact closure to make the output relay return to normal state

11-12/11-14 Output relay connections

Relay status: black color = energized.

NOTE: In "Memory" mode, the relay opens after the time delay and stays in that position when crossing of the threshold is detected. The power supply voltage must be switched off to reset the product.

With inhibition by S2 ("Inhib./S2" mode)

