

Modicon M340

BMX NOC 0401

Ethernet Communication Module

User Manual

Original instructions

10/2019



The information provided in this documentation contains general descriptions and/or technical characteristics of the performance of the products contained herein. This documentation is not intended as a substitute for and is not to be used for determining suitability or reliability of these products for specific user applications. It is the duty of any such user or integrator to perform the appropriate and complete risk analysis, evaluation and testing of the products with respect to the relevant specific application or use thereof. Neither Schneider Electric nor any of its affiliates or subsidiaries shall be responsible or liable for misuse of the information contained herein. If you have any suggestions for improvements or amendments or have found errors in this publication, please notify us.

You agree not to reproduce, other than for your own personal, noncommercial use, all or part of this document on any medium whatsoever without permission of Schneider Electric, given in writing. You also agree not to establish any hypertext links to this document or its content. Schneider Electric does not grant any right or license for the personal and noncommercial use of the document or its content, except for a non-exclusive license to consult it on an "as is" basis, at your own risk. All other rights are reserved.

All pertinent state, regional, and local safety regulations must be observed when installing and using this product. For reasons of safety and to help ensure compliance with documented system data, only the manufacturer should perform repairs to components.

When devices are used for applications with technical safety requirements, the relevant instructions must be followed.

Failure to use Schneider Electric software or approved software with our hardware products may result in injury, harm, or improper operating results.

Failure to observe this information can result in injury or equipment damage.

© 2019 Schneider Electric. All rights reserved.

Table of Contents



	Safety Information	9
	About the Book	13
Chapter 1	Installation	15
	Physical Description of the BMX NOC 0401 Module	16
	Standards and Certifications	19
	Communication Module Specifications	20
	Communication Specifications	22
	Mounting the BMX NOC 0401 Module	24
	Installing Control Expert Ethernet Configuration Tool Software	26
	Uninstalling the Ethernet Configuration Tool	28
Chapter 2	Configuring the Ethernet Communication Module	29
2.1	Ethernet Network Configuration Example	30
	The Ethernet Network Example	30
2.2	Creating a Project in Control Expert	32
	Creating a Project in Control Expert	33
	Configuring the Size and Location of Inputs and Outputs	38
2.3	The Control Expert FDT/DTM Interface	41
	DTM Browser	42
	DTM Browser Menu Commands	45
	Field Bus Discovery Service	51
	Device Editor	55
	Configuring Properties in the Device Editor	57
	Uploading and Downloading DTM-Based Applications	59
2.4	Channel Properties	62
	Channel Properties Page	63
	Channel Properties - Switch Settings	65
	Channel Properties - QoS Queue	67
	Channel Properties — TCP/IP Page	70
	Channel Properties - EtherNet/IP Page	75
2.5	Ethernet Services	77
	Enabling Ethernet Services	78
	Configuring the DHCP and FDR Servers	80
	Configuring the SNMP Agent	86
	Configuring Access Control	89
	Configuring QoS Ethernet Packet Tagging	92

	Configuring the Rapid Spanning Tree Protocol	96
	Configuring the Email Service	100
	Sending Email via the SEND_EMAIL Block	103
	Configuring the Network Time Service	105
2.6	Security	108
	Security Features	108
2.7	Configuring the Ethernet Communication Module as an EtherNet/IP Adapter	110
	Introducing the Local Slave	111
	Configuring a Local Slave	113
	Local Slave Inputs and Outputs	118
Chapter 3	Adding Devices to an Ethernet Network	125
3.1	Hardware Catalog	126
	Adding a DTM to the Control Expert Hardware Catalog	127
	Add an EDS File to the Control Expert Hardware Catalog	128
	Updating the Control Expert Hardware Catalog	131
	Remove an EDS File from the Control Expert Hardware Catalog	133
3.2	Adding an EtherNet/IP Device to the Network	135
	Setting Up Your Network	136
	Adding an STB NIC 2212 Remote Device	138
	Configuring STB NIC 2212 Properties	140
	Configuring EtherNet/IP Connections	146
	Connecting to the Advantys STB Island	152
	Configuring I/O Items	156
3.3	Adding a Modbus TCP Device to the Network	170
	Setting Up Your Network	171
	Adding an STB NIP 2212 Remote Device	173
	Configuring STB NIP 2212 Properties	175
	Connecting to the Advantys STB Island	183
	Configuring I/O Items	187
Chapter 4	Working With Derived Data Types	197
	Creating and Updating Derived Data Types	198
	Working with Derived Data Type Variables	200
	Effect of Activating and De-activating Devices on I/O %MW Memory Addresses	209

Chapter 5	Optimizing Performance	213
5.1	Selecting a Switch	214
	Role of a Switch in an Ethernet Network	215
	Transmission Speed, Duplex and Auto-Negotiation	216
	Quality of Service (QoS)	217
	IGMP Snooping	218
	Rapid Spanning Tree Protocol (RSTP)	219
	Virtual Local Area Network (VLAN)	220
	Port Mirroring	222
	Simple Network Management Protocol (SNMP) Agent	223
5.2	Control Application Design	224
	Message Types	225
	Message Connection Types	227
	TCP and CIP Connections	229
	Message Priority	230
	Messaging Performance	231
	Message Frequency	232
	Allocating Network Bandwidth	234
	Estimating Message Traverse and Response Times	236
5.3	Projecting Ethernet Network Performance	238
	Network Load and Bandwidth Calculation Example	238
Chapter 6	CIP Objects	243
	Identity Object	245
	Assembly Object	247
	Connection Manager Object	249
	Modbus Object	251
	Quality Of Service (QoS) Object	253
	TCP/IP Interface Object	255
	Ethernet Link Object	257
	EtherNet/IP Interface Diagnostics Object	262
	EtherNet/IP IO Scanner Diagnostics Object	265
	IO Connection Diagnostics Object	267
	EtherNet/IP Explicit Connection Diagnostics Object	271
	EtherNet/IP Explicit Connection Diagnostics List Object	273

Chapter 7 Online Action	277
Accessing CIP Objects	278
Editing Port Configuration Properties for Remote EtherNet/IP Devices	280
Pinging a Network Device	282
Viewing and Editing Online Settings for a Remote Device	284
Chapter 8 Explicit Messaging	287
8.1 Explicit Messaging Using the DATA_EXCH Block	288
Configuring Explicit Messaging Using DATA_EXCH	289
Configuring the DATA_EXCH Management Parameter	291
8.2 EtherNet/IP Explicit Messaging Using DATA_EXCH	293
Explicit Messaging Services	294
Configuring EtherNet/IP Explicit Messaging Using DATA_EXCH	296
EtherNet/IP Explicit Message Example: Get_Attribute_Single	298
EtherNet/IP Explicit Message Example: Read Modbus Object	302
EtherNet/IP Explicit Message Example: Write Modbus Object	306
8.3 Modbus TCP Explicit Messaging Using DATA_EXCH	310
Modbus TCP Explicit Messaging Function Codes	311
Configuring Modbus TCP Explicit Messaging Using DATA_EXCH	312
Modbus TCP Explicit Message Example: Read Register Request	314
8.4 Explicit Messaging via the Control Expert GUI	319
Sending Explicit Messages to EtherNet/IP Devices	320
Sending Explicit Messages to Modbus TCP Devices	323
Chapter 9 Diagnostics	325
9.1 Module Hardware Diagnostics	326
LED Indicators for the BMX NOC 0401	326
9.2 Control Expert Software Diagnostics	328
Using the Diagnostic Window	329
Ethernet Port Diagnostics	332
Bandwidth Diagnostics	336
Email Diagnostics	339
Network Time Service Diagnostics	341
Communication Module RSTP Diagnostics	344
Local Slave / Connection Diagnostics	347
Local Slave or Connection I/O Value Diagnostics	351
Logging	353

9.3	CPU I/O Block Diagnostics	355
	Accessing the Control Expert Diagnostic Tools	356
	Communication Channel Diagnostics in Control Expert	358
	Communication Module Diagnostics in Control Expert	360
Chapter 10	Replacing the Ethernet Communication Module	367
	Replacing the Ethernet Communication Module	367
Chapter 11	Embedded Web Pages	369
11.1	Accessing the Embedded Web Server	370
	Introducing the Embedded Web Pages	371
	Accessing the Home Page	372
	Using and Editing a Username and Passwords	373
	Configuring Port Mirroring	376
11.2	Monitoring the Control Expert Application	378
	Using the Monitoring Page	379
	Data Editor (Standard)	380
	Working With Data Templates	385
	Data Editor (Lite)	389
11.3	Diagnostics	391
	Using the Diagnostics Page	392
	Status Summary	393
	Rack Viewer	396
	Processor Load	398
	Scanner Status	401
	Messaging	403
	QoS Configuration	405
	Port Statistics	407
	Redundancy	410
	Email Diagnostics	411
	Network Time Service Diagnostics	414
	Properties	416
Appendices	417
Appendix A	Detected Error Codes	419
	EtherNet/IP Implicit or Explicit Messaging Detected Error Codes	420
	Explicit Messaging: Communication and Operation Reports	423
Appendix B	CIP General Status Codes	427
	CIP General Status Codes	427
Appendix C	Modbus Exception Response Codes	431
	MODBUS Exception Response Codes	431

Appendix D	Email Detected Error Response Codes	433
	Electronic Mail Notification Service Detected Error Response Codes .	433
Glossary	435
Index	437

Safety Information



Important Information

NOTICE

Read these instructions carefully, and look at the equipment to become familiar with the device before trying to install, operate, service, or maintain it. The following special messages may appear throughout this documentation or on the equipment to warn of potential hazards or to call attention to information that clarifies or simplifies a procedure.



The addition of this symbol to a “Danger” or “Warning” safety label indicates that an electrical hazard exists which will result in personal injury if the instructions are not followed.



This is the safety alert symbol. It is used to alert you to potential personal injury hazards. Obey all safety messages that follow this symbol to avoid possible injury or death.

DANGER

DANGER indicates a hazardous situation which, if not avoided, **will result in death** or serious injury.

WARNING

WARNING indicates a hazardous situation which, if not avoided, **could result in death** or serious injury.

CAUTION

CAUTION indicates a hazardous situation which, if not avoided, **could result** in minor or moderate injury.

NOTICE

NOTICE is used to address practices not related to physical injury.

PLEASE NOTE

Electrical equipment should be installed, operated, serviced, and maintained only by qualified personnel. No responsibility is assumed by Schneider Electric for any consequences arising out of the use of this material.

A qualified person is one who has skills and knowledge related to the construction and operation of electrical equipment and its installation, and has received safety training to recognize and avoid the hazards involved.

BEFORE YOU BEGIN

Do not use this product on machinery lacking effective point-of-operation guarding. Lack of effective point-of-operation guarding on a machine can result in serious injury to the operator of that machine.

WARNING

UNGUARDED EQUIPMENT

- Do not use this software and related automation equipment on equipment which does not have point-of-operation protection.
- Do not reach into machinery during operation.

Failure to follow these instructions can result in death, serious injury, or equipment damage.

This automation equipment and related software is used to control a variety of industrial processes. The type or model of automation equipment suitable for each application will vary depending on factors such as the control function required, degree of protection required, production methods, unusual conditions, government regulations, etc. In some applications, more than one processor may be required, as when backup redundancy is needed.

Only you, the user, machine builder or system integrator can be aware of all the conditions and factors present during setup, operation, and maintenance of the machine and, therefore, can determine the automation equipment and the related safeties and interlocks which can be properly used. When selecting automation and control equipment and related software for a particular application, you should refer to the applicable local and national standards and regulations. The National Safety Council's Accident Prevention Manual (nationally recognized in the United States of America) also provides much useful information.

In some applications, such as packaging machinery, additional operator protection such as point-of-operation guarding must be provided. This is necessary if the operator's hands and other parts of the body are free to enter the pinch points or other hazardous areas and serious injury can occur. Software products alone cannot protect an operator from injury. For this reason the software cannot be substituted for or take the place of point-of-operation protection.

Ensure that appropriate safeties and mechanical/electrical interlocks related to point-of-operation protection have been installed and are operational before placing the equipment into service. All interlocks and safeties related to point-of-operation protection must be coordinated with the related automation equipment and software programming.

NOTE: Coordination of safeties and mechanical/electrical interlocks for point-of-operation protection is outside the scope of the Function Block Library, System User Guide, or other implementation referenced in this documentation.

START-UP AND TEST

Before using electrical control and automation equipment for regular operation after installation, the system should be given a start-up test by qualified personnel to verify correct operation of the equipment. It is important that arrangements for such a check be made and that enough time is allowed to perform complete and satisfactory testing.

WARNING

EQUIPMENT OPERATION HAZARD

- Verify that all installation and set up procedures have been completed.
- Before operational tests are performed, remove all blocks or other temporary holding means used for shipment from all component devices.
- Remove tools, meters, and debris from equipment.

Failure to follow these instructions can result in death, serious injury, or equipment damage.

Follow all start-up tests recommended in the equipment documentation. Store all equipment documentation for future references.

Software testing must be done in both simulated and real environments.

Verify that the completed system is free from all short circuits and temporary grounds that are not installed according to local regulations (according to the National Electrical Code in the U.S.A, for instance). If high-potential voltage testing is necessary, follow recommendations in equipment documentation to prevent accidental equipment damage.

Before energizing equipment:

- Remove tools, meters, and debris from equipment.
- Close the equipment enclosure door.
- Remove all temporary grounds from incoming power lines.
- Perform all start-up tests recommended by the manufacturer.

OPERATION AND ADJUSTMENTS

The following precautions are from the NEMA Standards Publication ICS 7.1-1995 (English version prevails):

- Regardless of the care exercised in the design and manufacture of equipment or in the selection and ratings of components, there are hazards that can be encountered if such equipment is improperly operated.
- It is sometimes possible to misadjust the equipment and thus produce unsatisfactory or unsafe operation. Always use the manufacturer's instructions as a guide for functional adjustments. Personnel who have access to these adjustments should be familiar with the equipment manufacturer's instructions and the machinery used with the electrical equipment.
- Only those operational adjustments actually required by the operator should be accessible to the operator. Access to other controls should be restricted to prevent unauthorized changes in operating characteristics.

About the Book



At a Glance

Document Scope

This manual describes the use of the Modicon M340 BMX NOC 0401 Ethernet communication module. This manual describes the creation of a complete configuration. The features and functions of the module are described in the course of constructing this configuration.

The specific configuration settings contained in this manual are intended to be used for instructional purposes only. The settings required for your specific configuration differ from the examples presented in this manual.

Validity Note

This documentation is valid for EcoStruxure™ Control Expert 14.1 or later.

Related Documents

For additional information, refer to the online help files for the Control Expert software, and to the following technical publications:

Title of Documentation	Reference Number
Modicon M580, M340, and X80 I/O Platforms, Standards and Certifications	EIO0000002726 (English), EIO0000002727 (French), EIO0000002728 (German), EIO0000002730 (Italian), EIO0000002729 (Spanish), EIO0000002731 (Chinese)
Advantys STB EtherNet/IP Network Interface Applications Guide	31008204 (English), 31008205 (French), 31008206 (German), 31008207 (Spanish), 31008208 (Italian)

You can download these technical publications and other technical information from our website at <https://www.schneider-electric.com/en/download>

Chapter 1

Installation

Overview

The Ethernet communication module serves as the interface between a M340 PLC and other Ethernet network devices by means of either the EtherNet/IP or the Modbus TCP communication protocol. This chapter shows you how to install the module by:

- inserting it into a PLC backplane
- connecting it to an Ethernet network
- installing the Control Expert Ethernet Configuration Tool software

What Is in This Chapter?

This chapter contains the following topics:

Topic	Page
Physical Description of the BMX NOC 0401 Module	16
Standards and Certifications	19
Communication Module Specifications	20
Communication Specifications	22
Mounting the BMX NOC 0401 Module	24
Installing Control Expert Ethernet Configuration Tool Software	26
Uninstalling the Ethernet Configuration Tool	28

Physical Description of the BMX NOC 0401 Module

Front

The front of the module presents the following features:

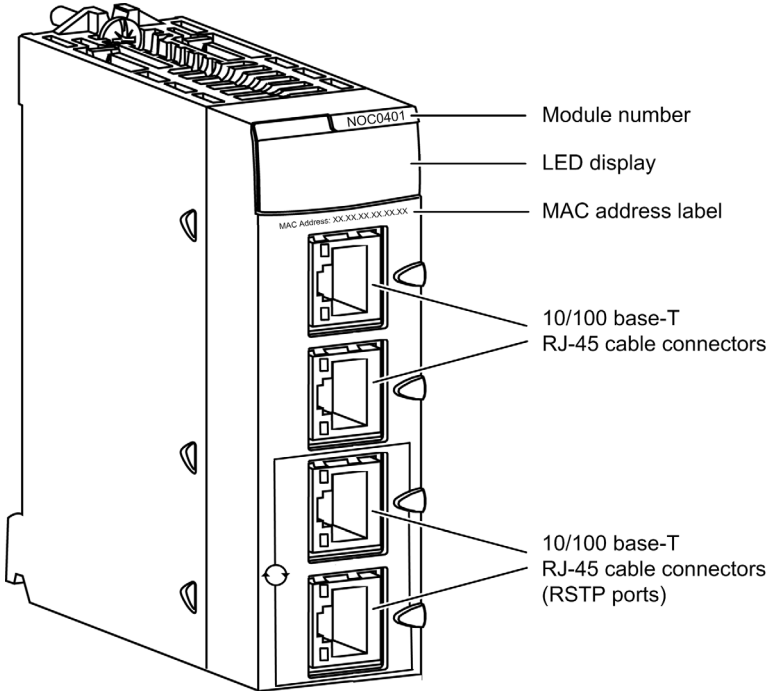

Rotary Switches

The back of the BMX NOC 0401 presents two rotary switches, which you can use to specify how the module will obtain its IP address.

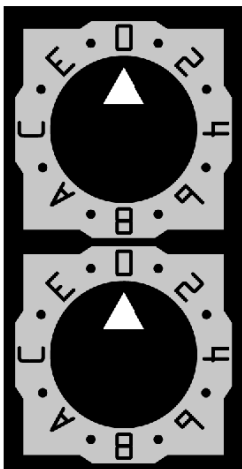

The settings of these two rotary switches work together to specify the source of the module's IP address, as follows:

Setting	Description
Upper switch:	
0...9	Tens value (0, 10, 20...90) for the device name setting. It is added to the ones value on the lower switch to identify the module to a DHCP server.
A...F	Tens value (100, 200, 300... 150) for the device name setting. It is added to the ones value on the lower switch to identify the module to a DHCP server.
Lower switch:	
0...9	Ones value (0, 1, 2...9) for the device name setting. It is added to the tens value on the upper switch to identify the module to a DHCP server.
A + B	BootP ¹ : The module obtains its IP address from a BootP server.
C + D	Stored ¹ : The module uses the IP address configured in the application.
E + F	Clear IP ¹ : The module applies its default IP address.
1. The lower switch alone determines module behavior. The upper switch is ignored.	

Switch Labels

The right side of the module displays two labels explaining the choice of rotary switch settings, as depicted below.

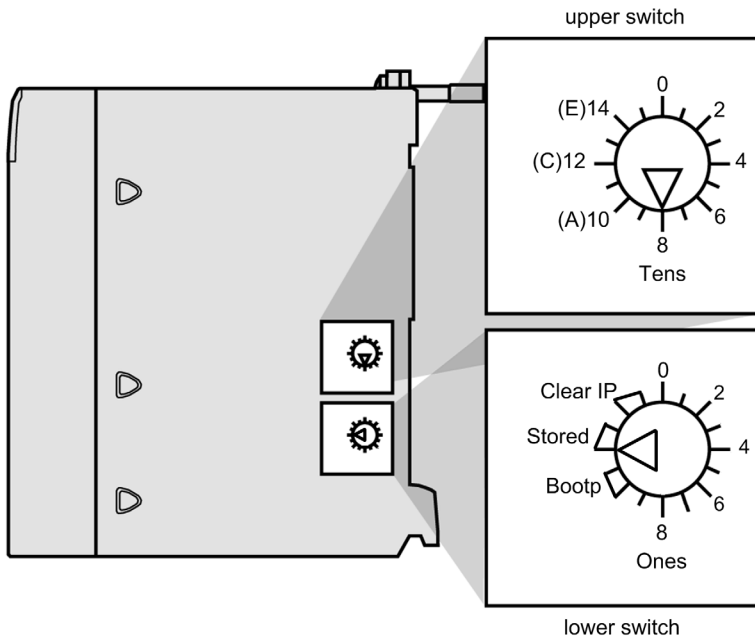

LEDs

The BMX NOC 0401 communication module presents the following LED indicators:

- RUN (running)
- ERR (detected error)
- MS (module status)
- NS (network status)
- ETH STS (Ethernet status)

In addition, each Ethernet port presents the following two LED indicators:

- LNK (link)
- ACT (activity)

For a description of these LEDs, and how to use them to diagnose the communication module, refer to the topic LED Indicators for the Ethernet Communication Module ([see page 326](#)).

Standards and Certifications

Download

Click the link that corresponds to your preferred language to download standards and certifications (PDF format) that apply to the modules in this product line:

Title	Languages
Modicon M580, M340, and X80 I/O Platforms, Standards and Certifications	<ul style="list-style-type: none"><li data-bbox="679 386 953 410">● English: EIO0000002726<li data-bbox="679 414 953 438">● French: EIO0000002727<li data-bbox="679 441 953 466">● German: EIO0000002728<li data-bbox="679 469 953 493">● Italian: EIO0000002730<li data-bbox="679 496 953 521">● Spanish: EIO0000002729<li data-bbox="679 524 953 548">● Chinese: EIO0000002731

Communication Module Specifications

Altitude Operating Conditions

The characteristics apply to the module BMX NOC 0401 for use at altitude up to 2000 m (6560 ft). When the module operate above 2000 m (6560 ft), apply additional derating.

For detailed information, refer to chapter *Operating and Storage Conditions* (see *Modicon M580, M340, and X80 I/O Platforms, Standards and Certifications*).

Specifications

BMX NOC 0401 specifications include:

Environmental	
Operating Temperature	0...+60 °C (+32...+140 °F)
Ports	
Communication Ports	Four auto-sensing 10/100Base-T shielded twisted pair (RJ-45 connector) ports.
Electrical	
Bus Current Required	@3.3V: 550 mA
Power Dissipation	1.9 W
Fuse	None

Software Compatibility

The Ethernet communication module is compatible with Unity Pro programming software version 5.0 and later.

NOTE: Unity Pro is the former name of Control Expert for version 13.1 or earlier.

Communication Modules per Station

The maximum number of communication modules — including but not limited to BMX NOC 0401 Ethernet communication modules — you can install in a single station is determined by the CPU serving that station

CPU	Maximum Number of Communication Modules per Station
BMX P34 1000	2
BMX P34 2000	3
BMX P34 2010	3
BMX P34 20102	3
BMX P34 2020	3
BMX P34 2030	3
BMX P34 20302	3

NOTE: If you use the embedded Ethernet port with the BMX P34 2*** copro, the maximum number of communication modules per station is two.

Communication Specifications

Introduction

The following specifications describe both the I/O communication and the explicit messaging capacities of the BMX NOC 0401.

I/O Communication Specifications

The Ethernet communication module presents the following I/O communication features:

Communication type	Feature	Capacity
EtherNet/IP (CIP Implicit Messaging)	Scanner	
	Maximum number of devices	128 devices (125 devices as scanner + 3 devices as adapter) shared with Modbus TCP
	Maximum message size	512 bytes
	Adapter	
	Maximum number of instances	3 adapter instances
	Maximum number of connections	2 connections per instance
	Maximum message size	511 bytes including header
	Inputs	505 bytes excluding header
	Outputs	509 bytes excluding header
Modbus TCP (Modbus Scanner)	Maximum number of registers	
	Read	125 registers
	Write	120 registers
	Maximum number of devices	128 devices shared with EtherNet/IP
	Maximum message size	
	Read	250 bytes (125 words) excluding header
	Write	240 bytes (120 words) excluding header

Explicit Messaging Specifications

The Ethernet communication module presents the following explicit messaging features:

Communication type	Feature	Capacity
EtherNet/IP (CIP Explicit Messaging)	Client	
	Maximum number of simultaneous connections	16 connections
	Maximum number of concurrent requests	16 requests, shared with Modbus TCP
	Server	
	Maximum number of simultaneous connections	32 connections
	Maximum messaging size	1023 bytes
Modbus TCP (Modbus Scanner)	Client	
	Maximum number of simultaneous connections	16 connections
	Maximum number of concurrent requests	16 requests, shared with EtherNet/IP
	Server	
	Maximum number of simultaneous requests	128 requests
	Maximum number of simultaneous connections	32 connections
	Maximum message size	
	Read	250 bytes (125 words) excluding header
	Write	240 bytes (120 words) excluding header

Mounting the BMX NOC 0401 Module

Tools Required

One medium sized (size 2) Phillips-head screw driver.

Mounting the Module

The module can be mounted in any of the racks of the Modicon M340 system. It can be installed in any available slot (except in the offset X Bus racks). To mount the communication module:

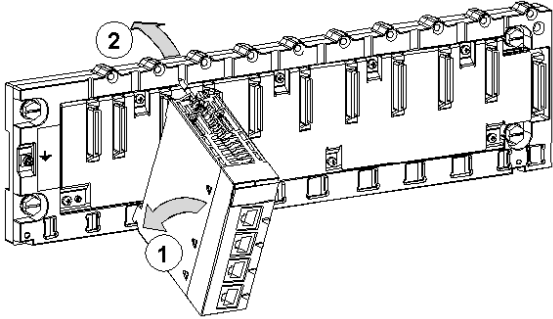
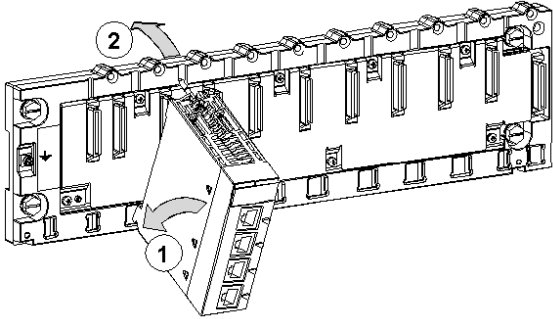
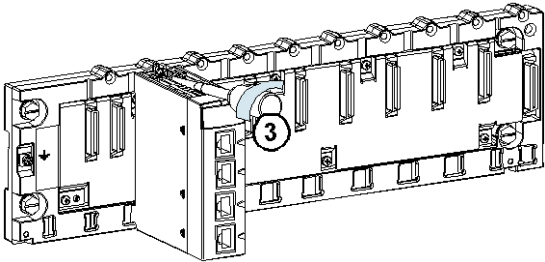
Step	Action	Illustration
1	Position the locating pins (situated at the bottom part of the rear of the module) in the corresponding slots.	
2	Swivel the module upwards toward the top of the rack, so that the back of the module sits flush with the rack. NOTE: Before positioning the pins, remove the pins protective cover.	
3	Tighten the screw to hold the module in place on the rack. NOTE: The tightening torque is 0.4...1.5 N·m (0.30...1.10 lbf-ft).	

Wiring

WARNING

HAZARD OF ELECTRICAL SHOCK OR BURN

Connect the ground wire to the protective ground (PE) terminal before you establish any further connections. When you remove connections, disconnect the ground wire last. The Ethernet cable shield must be connected to PE ground at the Ethernet switch.

Failure to follow these instructions can result in death, serious injury, or equipment damage.

The Ethernet communication module communicates over an industrial Ethernet network through any one of four RJ45 connectors located on the front of the module.

- Use the top two ports (ports 1 and 2) to connect to end devices.
- Use the bottom two ports (ports 3 and 4)—which support the RSTP redundancy protocol—to connect to the local area networks, for example, a ring.

Installing Control Expert Ethernet Configuration Tool Software

Overview

Accessing Control Expert Configuration Tool Software depends on the software version you are using:

- Unity Pro version 6.0 and higher: The module configuration software is already included in the software installation.
- Unity Pro version 5.0: You need to install the Ethernet Configuration Tool software, which you can obtain from the following website:
<http://www.global-download.schneider-electric.com/8525773E00058BDC/all/DA00A87B8BB30386852577940058D66C>

NOTE: Unity Pro is the former name of Control Expert for version 13.1 or earlier.

Installing Ethernet Configuration Tool Software for Unity Pro Version 5.0

To install this software, navigate to the root of the installation files and run the file **Setup.exe**.

The setup process displays the following setup screens:

Step	Screen	Description
1	Welcome	Click Next to continue.
2	ReadMe and Release Notes Display	Indicate whether to display the ReadMe file. Click Next to continue.
3	ReadMe	(Optional) Displays the ReadMe file, if selected above. Click Next to continue.
4	License Agreement	Displays the software license. Select I accept... , then click Next to continue.
5	Customer Information	Enter the following data: <ul style="list-style-type: none"> ● your first and last names ● company name ● identify for whom the software is installed: <ul style="list-style-type: none"> ○ anyone who uses this computer ○ only for yourself Click Next to continue.
6	Destination Folder	Identify where the application will be installed. Either: <ul style="list-style-type: none"> ● Accept the default path ● Click Change... and specify a new path Click Next to continue.
7	Ready to Install	Click Next to continue.
8	Status	Progress bar indicates the status of the installation. When complete, click Next to continue.
9	Install Complete	Click Finish .

The installation process described above copies the following objects to your PC:

- the Ethernet Configuration Tool
- a Generic EtherNet/IP DTM
- a Generic Modbus TCP DTM

NOTE: A DTM is a small software driver that defines and enables a device.

Updating Hardware Catalog

For installations of Unity Pro version 5.0 and higher, the next step is to update the **Hardware Catalog**. Updating the **Hardware Catalog** adds your new Ethernet communication module to the list of available modules and devices that you can add to your application.

Refer to the topic Updating the Control Expert Hardware Catalog (*see page 131*) for step-by-step instructions.

Uninstalling the Ethernet Configuration Tool

Introduction

Use the **Add or Remove Programs** utility provided by the Windows™ operating system to uninstall the Ethernet Configuration Tool.

To completely uninstall the Ethernet Configuration Tool, remove each of the following three DTMs, one at a time:



Generic EtherNet/IP DTM



Generic Modbus TCP DTM



Unity Pro Ethernet Configuration Tool

Uninstalling the Ethernet Configuration Tool DTMs

To remove the three Ethernet Configuration Tool DTMs:

Step	Action
1	Open the Windows Control Panel: Start → Settings → Control Panel.
2	In the Control Panel , double click on Add or Remove Programs.
3	In the Add or Remove Programs window, select the Change or Remove Programs page.
4	Select the first of the three DTMs to remove (for example, the Generic EtherNet/IP DTM), then click Remove.
5	Repeat step 4 for each of the remaining 2 DTMs: Generic Modbus DTM and Control Expert Ethernet Configuration Tool.

Chapter 2

Configuring the Ethernet Communication Module

Overview

This chapter shows you how to use Control Expert programming software to select and configure the Ethernet communication module.

NOTE: The instructions presented in this chapter include specific choices made for a sample project. Your project may include different choices that are appropriate for your specific configuration.

What Is in This Chapter?

This chapter contains the following sections:

Section	Topic	Page
2.1	Ethernet Network Configuration Example	30
2.2	Creating a Project in Control Expert	32
2.3	The Control Expert FDT/DTM Interface	41
2.4	Channel Properties	62
2.5	Ethernet Services	77
2.6	Security	108
2.7	Configuring the Ethernet Communication Module as an EtherNet/IP Adapter	110

Section 2.1

Ethernet Network Configuration Example

The Ethernet Network Example

The Ethernet Network

This manual describes the creation of a complete Ethernet network configuration for the following topology:

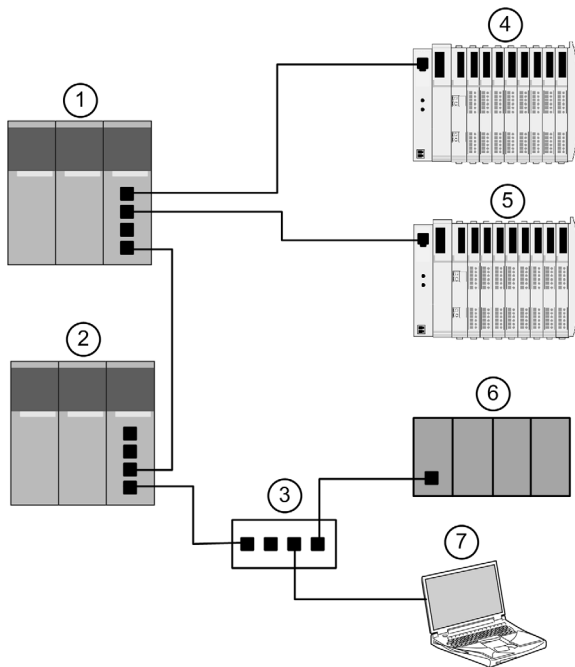

- 1 Primary PLC incorporating the BMX NOC 0401 Ethernet communication module
- 2 A secondary PLC that “listens” to the scan of the primary PLC local slave by the third-party scanner
- 3 Ethernet managed switch
- 4 Advantys STB island, with an STB NIC 2212 EtherNet/IP network interface module plus 8 I/O modules
- 5 Advantys STB island, with an STB NIP 2212 Modbus TCP network interface module plus 8 I/O modules
- 6 Third-party PLC that scans a local slave in the primary PLC (1)
- 7 PC equipped with both Control Expert configuration software (upgraded with the Ethernet Configuration Tool that ships with the BMX NOC 0401 Ethernet communication module) and Advantys configuration software, used to configure communication settings for Ethernet communication module in the primary PLC (1) and the remote network interface modules on the STB I/O islands (4 and 5)

Multiple Roles of the PLC and Ethernet Communication Module

The PLC, and in particular the BMX NOC 0401 Ethernet communication module, can be configured to simultaneously perform multiple roles with respect to other network devices. In this sample network, you will learn how to configure the communication module to operate as:

- a scanner of devices that use the EtherNet/IP (4) and the Modbus TCP (5) protocols
- an adapter—also known as a local slave—that produces output data that both the remote third-party PLC (6) and secondary PLC (2) can read as input data
- a DHCP server that provides IP address settings to other devices on the Ethernet network
- an FDR server that provides operational settings to devices on the Ethernet network that also receive their IP address from the DHCP server, above

Section 2.2

Creating a Project in Control Expert

Overview

This section shows you how to add modules—including the BMX NOC 0401 Ethernet communication module—to your project, using Control Expert.

What Is in This Section?

This section contains the following topics:

Topic	Page
Creating a Project in Control Expert	33
Configuring the Size and Location of Inputs and Outputs	38

Creating a Project in Control Expert

Introduction

This topic shows you how to create a new Control Expert project, and add to the new project the following components:

- a CPU
- a power supply
- a BMX NOC 0401 Ethernet communication module

NOTE: The following example uses Unity Pro version 7.0, or higher.

NOTE: Unity Pro is the former name of Control Expert for version 13.1 or earlier.

Creating and Saving a New Project

Use Control Expert to create a new project. The following steps describe the creation of a project for the sample network:

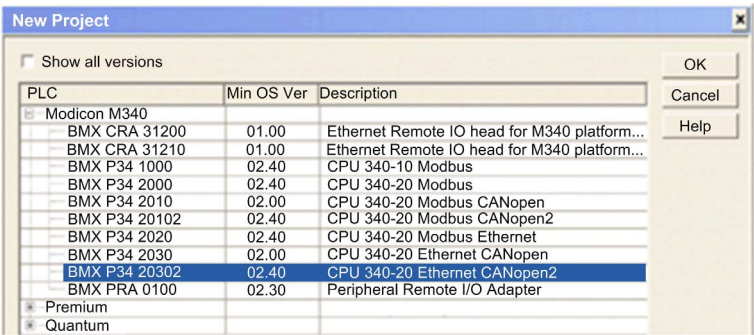
Step	Action																																										
1	Open Control Expert.																																										
2	In the main menu, select File → New... The New Project window opens displaying a list of Schneider-Electric controller types.																																										
3	In the New Project window, expand the Modicon M340 node to select a CPU.  <table border="1" data-bbox="336 906 980 1156"> <thead> <tr> <th>PLC</th> <th>Min OS Ver</th> <th>Description</th> </tr> </thead> <tbody> <tr> <td>Modicon M340</td> <td></td> <td></td> </tr> <tr> <td> BMX CRA 31200</td> <td>01.00</td> <td>Ethernet Remote I/O head for M340 platform...</td> </tr> <tr> <td> BMX CRA 31210</td> <td>01.00</td> <td>Ethernet Remote I/O head for M340 platform...</td> </tr> <tr> <td> BMX P34 1000</td> <td>02.40</td> <td>CPU 340-10 Modbus</td> </tr> <tr> <td> BMX P34 2000</td> <td>02.40</td> <td>CPU 340-20 Modbus</td> </tr> <tr> <td> BMX P34 2010</td> <td>02.00</td> <td>CPU 340-20 Modbus CANopen</td> </tr> <tr> <td> BMX P34 20102</td> <td>02.40</td> <td>CPU 340-20 Modbus CANopen2</td> </tr> <tr> <td> BMX P34 2020</td> <td>02.40</td> <td>CPU 340-20 Modbus Ethernet</td> </tr> <tr> <td> BMX P34 2030</td> <td>02.00</td> <td>CPU 340-20 Ethernet CANopen</td> </tr> <tr> <td> BMX P34 20302</td> <td>02.40</td> <td>CPU 340-20 Ethernet CANopen2</td> </tr> <tr> <td> BMX PRA 0100</td> <td>02.30</td> <td>Peripheral Remote I/O Adapter</td> </tr> <tr> <td> Premium</td> <td></td> <td></td> </tr> <tr> <td> Quantum</td> <td></td> <td></td> </tr> </tbody> </table> <p>In this example, select the BMX P34 20302 Ethernet CANopen2 controller.</p> <p>NOTE: By selecting the BMX P34 20302 Ethernet CANopen2 controller, you can later select the BMX NOC 0401.2 Ethernet communication module.</p>	PLC	Min OS Ver	Description	Modicon M340			BMX CRA 31200	01.00	Ethernet Remote I/O head for M340 platform...	BMX CRA 31210	01.00	Ethernet Remote I/O head for M340 platform...	BMX P34 1000	02.40	CPU 340-10 Modbus	BMX P34 2000	02.40	CPU 340-20 Modbus	BMX P34 2010	02.00	CPU 340-20 Modbus CANopen	BMX P34 20102	02.40	CPU 340-20 Modbus CANopen2	BMX P34 2020	02.40	CPU 340-20 Modbus Ethernet	BMX P34 2030	02.00	CPU 340-20 Ethernet CANopen	BMX P34 20302	02.40	CPU 340-20 Ethernet CANopen2	BMX PRA 0100	02.30	Peripheral Remote I/O Adapter	Premium			Quantum		
PLC	Min OS Ver	Description																																									
Modicon M340																																											
BMX CRA 31200	01.00	Ethernet Remote I/O head for M340 platform...																																									
BMX CRA 31210	01.00	Ethernet Remote I/O head for M340 platform...																																									
BMX P34 1000	02.40	CPU 340-10 Modbus																																									
BMX P34 2000	02.40	CPU 340-20 Modbus																																									
BMX P34 2010	02.00	CPU 340-20 Modbus CANopen																																									
BMX P34 20102	02.40	CPU 340-20 Modbus CANopen2																																									
BMX P34 2020	02.40	CPU 340-20 Modbus Ethernet																																									
BMX P34 2030	02.00	CPU 340-20 Ethernet CANopen																																									
BMX P34 20302	02.40	CPU 340-20 Ethernet CANopen2																																									
BMX PRA 0100	02.30	Peripheral Remote I/O Adapter																																									
Premium																																											
Quantum																																											

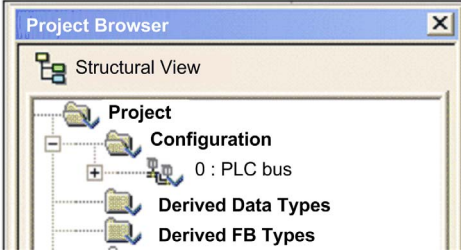
Step	Action
4	<p>Click OK. The Project Browser, below, opens.</p>  <p>The screenshot shows a window titled "Project Browser" with a close button (X) in the top right corner. Below the title bar is a "Structural View" pane. The view displays a tree structure of project elements: a "Project" folder, a "Configuration" folder, a "0 : PLC bus" folder, "Derived Data Types", and "Derived FB Types". Each folder has a small icon next to it, and the "0 : PLC bus" folder has a plus sign next to it, indicating it is expanded.</p>
5	<p>To save the project, select File → Save. The Save As dialog opens.</p>
6	<p>In the Save As dialog, type in a File name—which will be the name of your project—then click Save. Control Expert saves your project to the specified path location.</p> <p>NOTE: You can change the default location Control Expert uses to store project files. Before saving your project:</p> <ol style="list-style-type: none"> 1 Select Tools → Options. The Options Management window opens. 2 In the left pane, navigate to Options → General → Paths. 3 In the right pane, type in a new path location for the Project path. You can also edit the: <ul style="list-style-type: none"> ○ Import/Export file path ○ XVM path ○ Project settings templates path 4 Click OK close the window and save your path edits.

Adding a Power Supply to the New Project

When you added the CPU to the project, above, Control Expert may also have added a power supply to the project. If not, the next step is to manually add a power supply to your project:

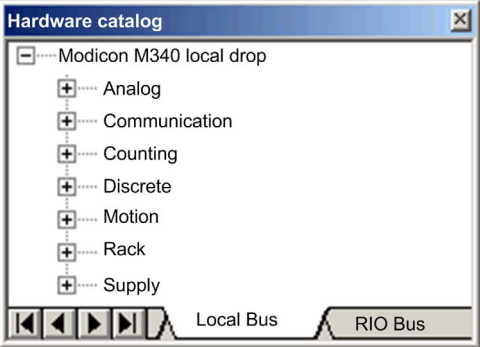
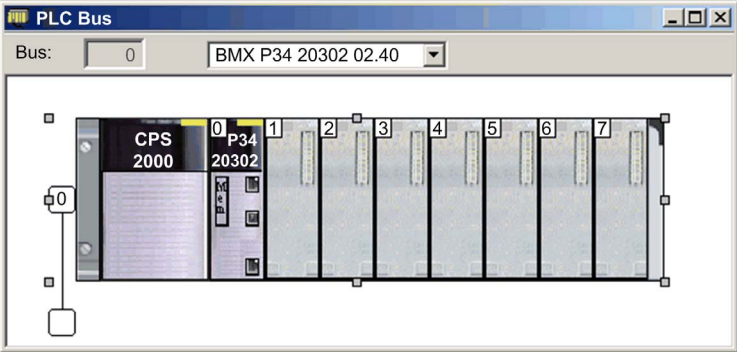
Step	Action
7	<p>In the Project Browser, double click 0 : PLC bus to display both the:</p> <ul style="list-style-type: none"> ● Local Bus window with the selected CPU in the second position, and ● Hardware catalog displaying the Local Bus tab, below: 
8	<p>In the Hardware catalog, under the Supply node, use your mouse to select then drag a BMX CPS 2000 power supply to the first position in the rack.</p> 
9	<p>In the File menu, select Save, to save your edits.</p> <p>NOTE: Schneider-Electric recommends that you periodically save your changes as you make edits.</p>

Adding an Ethernet Communication Module to the New Project

Next, add an Ethernet communication module to your project:

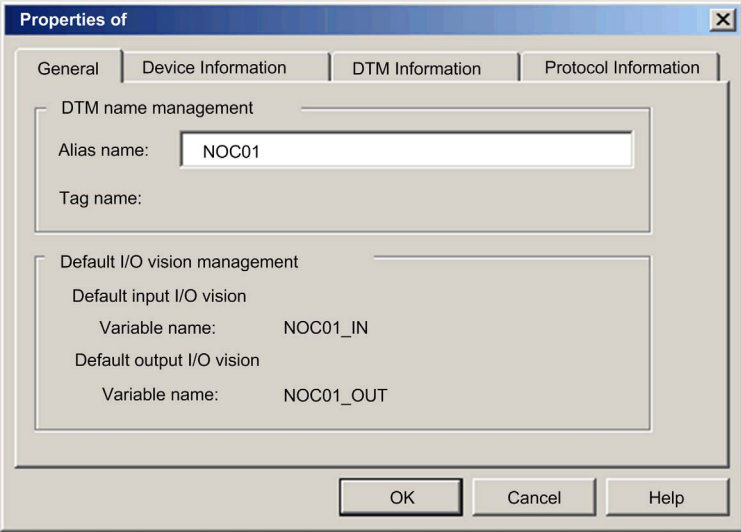
Step	Action
10	<p>Returning to the Hardware catalog, under the Communication node, use your mouse to select then drag a BMX NOC 0401.2 Ethernet communication module to an open slot in the rack—in this example, slot 2.</p> <p>NOTE: You can select the BMX NOC 0401.2 only after:</p> <ul style="list-style-type: none"> • selecting the BMX P34 20302 CPU for the project, and • upgrading the BMX NOC 0401 module firmware to version 2.0 or higher <p>When you drop the communication module into the rack, Control Expert opens the communication module Properties window.</p>
11	<p>In the General page of the module properties window, type in an alias name for the communication module: NOC01:</p>  <p>When you change the alias name, Control Expert changes the base input and output type and variable names to match the edited alias name.</p> <p>NOTE: Schneider Electric recommends that you assign a unique alias name to each communication module. This practice helps you distinguish between modules of the same type.</p>
12	<p>In the File menu, select Save, to save your edits.</p>

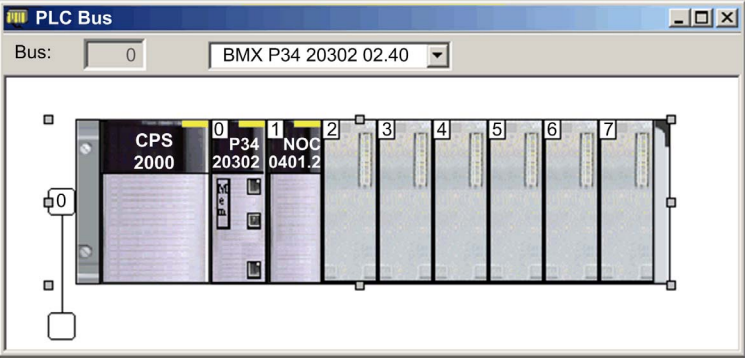
Step	Action
13	<p>Click OK to close the Properties window. The Local Bus now displays the three modules you have added:</p> 
14	<p>The next step is to configure the located memory space in the CPU for the communication module's inputs and outputs (see page 38).</p>

Configuring the Size and Location of Inputs and Outputs

Overview

Use the **Configuration** page of the Ethernet communication module's **Properties** window to configure:

- the size and starting position of inputs
- the size and starting position of outputs

The following steps present one example of how to configure the size and location of inputs and outputs. Your own project configuration may differ.

Setting Input and Output Memory Addresses and Naming the Module

The **Properties** window opens when you double-click the left mouse button on the image of the BMX NOC 0401 communication module in either the **Local Bus** window, or the **Project Browser**.

When you select the **Configuration** page, it displays the network, or Alias, name. This is the name assigned to the network channel when the communication module was added to the project.

Use the **Configuration** page to edit the communication module inputs and outputs, as follows:

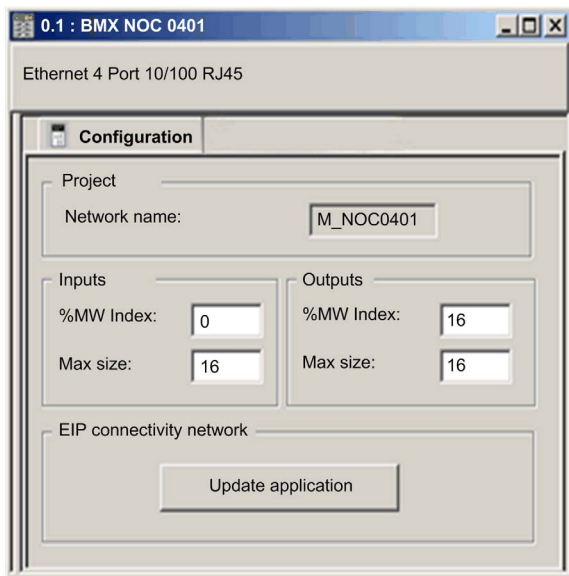

To input the above settings, take the following steps:

Step	Action
1	In the module's Properties window, select the Configuration page.
2	<p>Type in the size and starting position of the inputs and outputs, as follows:</p> <p>In the Inputs area:</p> <ul style="list-style-type: none"> ● In the %MW index field, type in a starting address for inputs, in this example: 0. ● In the Max size field, type in the maximum number of 16-bit words dedicated to inputs, in this example: 16. <p>In the Outputs area:</p> <ul style="list-style-type: none"> ● In the %MW index field, type in a starting address for outputs, in this example: 16. ● In the Max size field, type in the maximum number of 16-bit words dedicated to outputs—in this example: 16. <p>Notes:</p> <ul style="list-style-type: none"> ● Locate the inputs and outputs at the beginning of a 4-byte (or 2 word) range. Because address numbering in the M340 platform is zero-based, verify that %MW index input and output settings are configured to start at an even number. ● Allocate separate non-overlapping space to inputs and outputs. ● Control Expert automatically reserves space for two arrays of 32 bytes, as follows: <ul style="list-style-type: none"> ○ for connection health bits (<i>see page 203</i>), located at the beginning of the space configured for inputs ○ for connection control bits (<i>see page 207</i>), located at the beginning of the space configured for outputs ● Confirm that the %MW space assigned for both inputs and outputs is available in the CPU. For more information, refer to the Control Expert help file topic <i>Processor Configuration Screen</i>.
3	<p>In Control Expert select Edit → Validate (or click the Validate  button) to save the address and size settings for inputs and outputs.</p> <p>NOTE: After you validate module settings for the first time, the module name cannot be edited. If you subsequently decide to change the module name, delete the existing module from the configuration, then add and rename a replacement module.</p>

Completing the Ethernet Network Configuration

After configuring settings for inputs and outputs, the next step is to configure the communication module settings beginning with its **Channel Properties** and then configure remote Ethernet network devices (*see page 125*).

NOTE: After you input configuration settings for the communication module and remote devices, return to the **Configuration** page of the Ethernet communication module's **Properties** window and click the **Update application** button. This creates derived data type (DDT) variables (*see page 198*) that display the following information and commands for your project:

- connection health bits, that display the status of each connection
- connection control bits, you can use to toggle each connection on and off
- the value of input and output items
- module and device configuration settings
- free memory space that has been reserved, but not yet allocated

Section 2.3

The Control Expert FDT/DTM Interface

Overview

The section describes the use of DTMs within Control Expert.

What Is in This Section?

This section contains the following topics:

Topic	Page
DTM Browser	42
DTM Browser Menu Commands	45
Field Bus Discovery Service	51
Device Editor	55
Configuring Properties in the Device Editor	57
Uploading and Downloading DTM-Based Applications	59

DTM Browser

Overview

The **DTM Browser** displays a hierarchical list of DTMs—in the form of nodes on a connectivity tree—that have been added to your Control Expert project. Each DTM node represents an actual module or device in your Ethernet network.

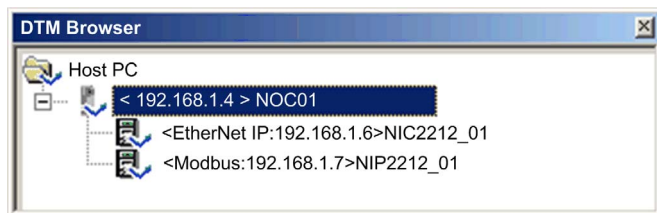

Node Types

There are 3 types of DTM nodes:

- Communication DTMs:
 - Any COM DTM can be plugged directly under the root node (Host PC) at the 1st level
 - A COM DTM can support Gateway DTMs or Device DTMs as children if their protocols are compatible
- Gateway DTMs:
 - A Gateway DTM can support other Gateway DTMs or Device DTMs as children if their protocols are compatible.
- Device DTMs:
 - A Device DTM does not support any child DTMs

Node Names

Each DTM has a default name when inserted into the browser. The default name consists of the following elements:



<Channel: Address> Device Name

Where:

Element	Description
channel	This is the name of the channel communication media, to which the device is plugged in. This name is read from the DTM and is set by the device vendor. Example: EtherNet/IP, Modbus
address	The bus address of the device, which can be: <ul style="list-style-type: none"> • The connection point on its parent gateway network • The slot number in the modular device parent internal bus Example: the device IP address
device name	The default name is determined by the vendor in the device DTM, but can be edited by the user.

Node Status

The **DTM Browser** displays the status of each DTM node in the connectivity tree, as follows:.

Status	Description
Built / Not-built	A blue check mark  superimposed on a device icon indicates that node, or one of its sub-nodes, is not built. This means that some property of the node has changed, and the information stored in the physical device is no longer consistent with the local project.
Connected / Disconnected	A connected DTM is denoted in bold text. An unconnected DTM appears in plain text. NOTE: <ul style="list-style-type: none"> • Connecting a DTM to its physical device automatically connects higher level parent nodes up to the root node. • Disconnecting a DTM from its physical device automatically disconnects its lower level child nodes. NOTE: Connecting or disconnecting a DTM to or from its device does not also connect or disconnect Control Expert to or from the PLC. DTMs can be connected/disconnected while Control Expert is either offline or online.
Installed / Not-installed	A red  superimposed on a device icon indicates the DTM for that device is not installed on the PC.

Handling Invalid Nodes

As indicated above, a red **X** superimposed on a node indicates the DTM for that node is not installed on the PC. To resolve this situation, click the right mouse button on the node to open a pop-up menu with the following two commands:

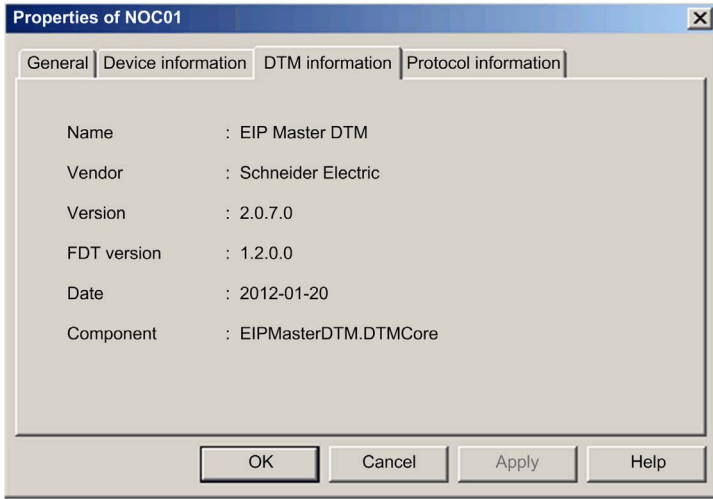
Command	Description
Delete	Removes the selected node (and its sub-nodes) from the DTM Browser .
Properties	<p>Opens the following dialog, which you can use to identify the name of the missing DTM:</p> 

DTM Browser Menu Commands

Overview

The **DTM Browser** includes a pop-up, contextual (right-click) menu that displays commands for the currently selected DTM. The list of available commands consists of:

- universal commands, as determined by the selected node level:
 - host PC node (level 1)
 - communication module node (level 2)
 - remote device node (level 3)
- device-specific commands, as determined by the device DTM

Host PC Node Commands

The **Host PC** node contextual menu includes the following commands:

Name	Description
Add ¹	Opens the Add dialog — containing a subset of the Hardware Catalog , allowing the selection of a communication module DTM.
Check DTM devices ¹	Checks the current project for invalid DTMs or DTMs that are not installed in the PC. If the results of the check include invalid or not-installed DTMs, they are displayed in the User errors tab in the information window and a red X is superimposed over their icons in the DTM Browser .
DTM services	Displays the communication DTMs selection, as well as the device topology, their respective IP addresses, and connection state. In this dialog, for each device you can connect, disconnect, load from devices, or store to devices. You can also choose to stop communication or continue activity when detected errors occur.
DTM hardware catalog	Displays the DTM catalog tab of the Hardware Catalog dialog.
Expand all ²	Displays every DTM in the project.
Collapse all ²	Displays only the communication DTMs in the project.
1. This command also appears in the Control Expert Edit menu. 2. This command also appears in the Control Expert View menu.	

Communication Module and Remote Device Node Commands

The **DTM Browser**'s contextual menu has the following items:

Name	Description
Open ¹	This opens the Device Editor for the selected communication module. NOTE: Double-clicking the left mouse button on the DTM in the DTM Browser also opens this window.
Add ¹	This opens the Add dialog, displaying a subset of the Hardware Catalog , allowing the selection of a DTM. NOTE: Control Expert filters the content of the Add dialog, so that it displays only DTMs that are compatible with the selected DTM selected.
Delete ¹	If the selected DTM allows this function, this deletes the selected DTM and its sub-node DTMs from the DTM connectivity tree. Deletion from the DTM connectivity tree does not affect the DTM's link to the I/O scanning table.
Field Bus Discovery	This scans the connected physical devices to create the corresponding field bus topology. Refer to the Field Bus Discovery Service topic.
Connect ¹	This connects the DTM (<i>see page 49</i>) to its physical device on the network. This connection does not depend on the PLC online/offline status of the Control Expert project application. NOTE: Connecting a gateway or device DTM implicitly connects its parent DTM.
Disconnect ¹	This disconnects the DTM (<i>see page 49</i>) from its physical device. This disconnection depends on the PLC online/offline status of the Control Expert project application. NOTE: Disconnecting a gateway or device DTM implicitly disconnects its parent DTM.
Load data from device ¹	This loads data from the physical device on the network to the DTM.
Store data to device ¹	This loads data from the DTM to the physical device on the network.
Copy	This command is disabled.
Paste	This command is disabled.
Device menu	This command opens a sub-menu that contains device-specific commands, as determined by the device vendor. For details, refer to the Communication Module Commands topic (<i>see page 47</i>).
Device menu 2	This command opens a sub-menu that contains device-specific commands, as determined by the device vendor. For details, refer to the Communication Module Commands topic (<i>see page 47</i>).
Properties ¹	Opens the Ethernet communication module Properties window.
1. This command also appears in the Control Expert Edit menu. 2. This command also appears in the Control Expert View menu.	

Name	Description
Print device ¹	<p>If this optional function is supported by a DTM, this function displays the device documentation — including configuration settings — in the PC's default Internet browser, which can then be printed.</p> <p>NOTE: Device information can be printed:</p> <ul style="list-style-type: none"> • for only one device DTM at a time, when that DTM is not open for editing in the Device Editor. • only when the DTM is disconnected from the physical device.
Zoom out ²	This returns to the display of the entire DTM connectivity tree.
Expand all ²	This displays DTMs below the selected DTM.
Collapse all ²	This displays only the selected DTM.
<p>1. This command also appears in the Control Expert Edit menu.</p> <p>2. This command also appears in the Control Expert View menu.</p>	

Communication Module Commands

When you select **Device menu** in the main contextual menu for the communication module, a sub-menu with the following commands is displayed:

Name	Description
Offline Parameter	This command is disabled.
Online Parameter	This command is disabled.
Compare	This compares 2 devices, either online or offline.
Configuration	This opens the Device Editor for the selected communication module, when the module and its DTM are disconnected.
Observe	This command is disabled.
Diagnosis	This opens the Diagnosis Window for the selected communication module, when the module and its DTM are connected.

Name		Description
Additional functions	Add EDS to library	Opens the EDS File Wizard , which you can use to add a device EDS file to the Control Expert EDS device library. Control Expert displays the contents of EDS files as DTMs for use in the DTM Browser and Device Editor .
	Remove EDS from library	Opens the EDS Deletion from Device Library window, which you can use to delete an EDS file from the device library.
	Online Action	Opens the Online Action window. Depending upon the protocol(s) a remote device supports, you can use the Online Action window to: <ul style="list-style-type: none"> ● Ping a remote EtherNet/IP or Modbus TCP device ● view and write to EtherNet/IP properties in a remote EtherNet/IP device ● view and write to port configuration properties in a remote EtherNet/IP device
	EtherNet/IP Explicit Message	Opens the EtherNet/IP Explicit Message (<i>see page 320</i>) window, which you can use to send explicit messages to EtherNet/IP remote devices.
	Modbus TCP Explicit Message	Opens the Modbus TCP Explicit Message (<i>see page 323</i>) window, which you can use to send explicit messages to Modbus TCP remote devices.
	About	
	Advanced Mode	Displays or hides expert-level properties that help define Ethernet connections. See the Enabling Advanced Mode topic (<i>see page 50</i>) for instruction on how to use this feature.

When you select **Device menu 2** in the main contextual menu for the communication module, a sub-menu with the following commands is displayed:

Name	Description
Configuration	This opens the Device Editor for the selected communication module, when the module and its DTM are disconnected.
Diagnosis	This opens the Diagnosis Window for the selected communication module, when the module and its DTM are connected.
Add EDS to library	Opens the EDS File Wizard , which you can use to add a device EDS file to the Control Expert EDS device library. Control Expert displays the contents of EDS files as DTMs for use in the DTM Browser and Device Editor .
Remove EDS from library	Opens the EDS Deletion from Device Library window, which you can use to delete an EDS file from the device library.
Online Action	Opens the Online Action window. Depending upon the protocol(s) a remote device supports, you can use the Online Action window to: <ul style="list-style-type: none"> ● Ping a remote EtherNet/IP or Modbus TCP device ● view and write to EtherNet/IP properties in a remote EtherNet/IP device ● view and write to port configuration properties in a remote EtherNet/IP device
EtherNet/IP Explicit Message	Opens the EtherNet/IP Explicit Message (<i>see page 320</i>) window, which you can use to send explicit messages to EtherNet/IP remote devices.

Name	Description
Modbus TCP Explicit Message	Opens the Modbus TCP Explicit Message (<i>see page 323</i>) window, which you can use to send explicit messages to Modbus TCP remote devices.
Advanced Mode	Displays or hides expert-level properties that help define Ethernet connections. See the Enabling Advanced Mode topic (<i>see page 50</i>) for instruction on how to use this feature.

Connecting and Disconnecting a Device or Module DTM

A device or module DTM can be either connected to, or disconnected from, the physical device or module.

When a device and its DTM are...	You can use the Ethernet configuration tool to...
Connected	Monitor and diagnose the real-time operation of the device or module
Disconnected	Configure a communication module or remote device by editing its properties

NOTE: Distinguish between:

- connecting and disconnecting a DTM and the associated physical device using commands in the **DTM Browser**
— and —
- placing Control Expert in online or offline operating mode using commands in the Control Expert **PLC** menu

You can connect a DTM to, or disconnect a DTM from a device or module using the contextual pop-up menu in the **DTM Browser**. The **DTM Browser** indicates the relationship between the DTM and the remote module or device: a connected DTM is displayed in **bold** text; a disconnected DTM is displayed in normal text.

To connect a DTM to, or disconnect a DTM from its respective module or device, follow these steps:

Step	Action
1	In the DTM Browser select the DTM that you want to connect to, or disconnect from, the physical communication module or remote device. NOTE: If the module or device name appears in: <ul style="list-style-type: none"> • bold text, it is connected and only the Disconnect command is enabled. • normal text, it is disconnected and only the Connect command is enabled.
2	Click the right-mouse button. Result: A pop-up menu opens.
3	Select one of the following commands: <ul style="list-style-type: none"> • Connect • Disconnect NOTE: The Connect and Disconnect commands are also available in the Control Expert Edit menu.

Enabling Advanced Mode

Use the contextual menu in the **DTM Browser** to toggle Control Expert in or out of **Advanced Mode**, thereby displaying or hiding expert-level properties that help define Ethernet connections. These properties are identified by the  icon.

NOTE: To maintain system performance, confirm that **Advanced Mode** properties are configured only by persons with a solid understanding of communication protocols.

To toggle **Advanced Mode** on and off:

Step	Action
1	Close both the Diagnosis Window and every instance of the Device Editor before attempting to toggle Advanced Mode on or off. NOTE: If the Device Editor or the Diagnosis Window is open, the Advanced Mode status — on or off — cannot be changed.
2	In the DTM Browser , right-click the communication module. Result: A pop-up menu opens.
3	To toggle ON advanced mode, select Device Menu → Advanced Mode .
4	To toggle OFF advanced mode, repeat steps 1 through 3, above.

Field Bus Discovery Service

Introduction

Use the field bus discovery service to detect and add to your Control Expert application, network devices that are situated on a local network. The field bus discovery service is available only when the Ethernet communication module DTM is connected to its physical device.

Only the first level devices below the communication DTM are detected.

Performing Field Bus Discovery

The results of the scanning process is compared to the registered DTMs in the DTM catalog of the computer. If a match is found in the DTM catalog for a scanned device, the results are accompanied with a matching type that gives the accuracy of the match.

These are the available matching types:

- *Exact match*: Every identification attribute matches. The correct device type was found.
- *Generic match*: At least the **Vendor** and device **Type ID** attributes match. The support level of the DTM is “Generic Support.”
- *Uncertain match*: At least the **Vendor** and device **Type ID** attributes match. The support level of the DTM is *not* “Generic Support.”

Use the field bus discovery service:

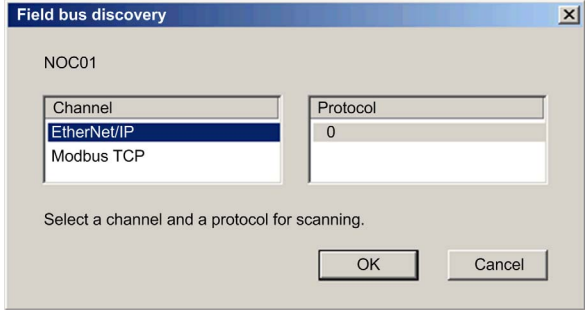
Step	Action
1	In the DTM Browser , select an appropriate DTM. NOTE: The field bus discovery service limits its search to the range of IP addresses that is pre-configured for the selected channel in the Channel Properties page (<i>see page 63</i>).
2	Right-click the DTM and scroll to Field bus discovery to open the dialog box: 
3	Under these conditions, select a channel and a protocol: <ul style="list-style-type: none"> ● The DTM has more than one channel. ● The channel supports more than one protocol.
4	Click on OK . The service starts to detect devices on the selected channel.

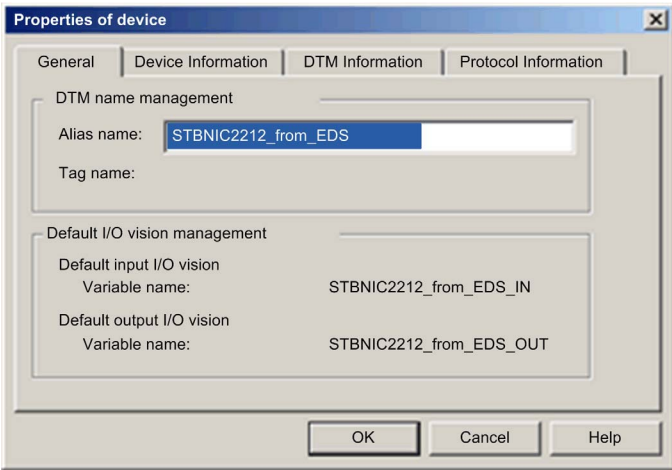
Step	Action
5	If at least one matched device has been found, the Field Bus Discovery dialog displays a list of Scanned Devices .
6	Use the controls of the Field Bus Discovery dialog to select the devices to add to your Control Expert application.
7	After you have selected the devices you want to add in the Field Bus Discovery dialog, click OK .
8	If the field bus discovery process finds at least one device with an IP address that is already used in the project, you are asked if you want to continue and replace the existing project device(s): <ul style="list-style-type: none"> ● Yes: Proceed to the next step. ● No: Cancel automatic field bus discovery.
9	<p>The device properties dialog (below) opens, displaying the default name for the first discovered device to be added:</p>  <p>In the General page of the device properties dialog, type in the Alias name for the device to be added, then click OK. The dialog closes, then re-opens if there is another device to be added to the application.</p>
10	Repeat the above step for each additional discovered device.
11	After you finish adding devices to the application, configure each device for operation as part of the application: <ul style="list-style-type: none"> ● Disconnect the Ethernet communication module from its DTM. In the DTM Browser, select the Ethernet communication module, then select Edit → Disconnect. ● Configure the new device properties in the DTMs for both the Ethernet communication module, and the newly added remote device.

Field Bus Discovery Dialog

If at least one matched device has been found, the Field Bus Discovery dialog box is displayed listing the scanned and matched devices. Select the matched devices to be created in the Control Expert project (which then shows up in the **Selected Devices** list):

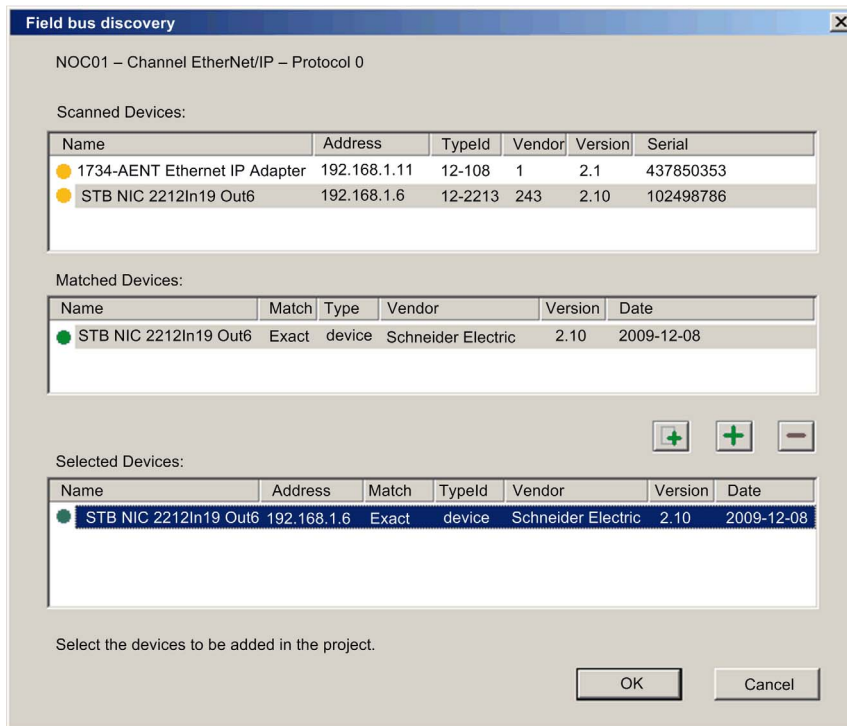



This dialog presents these lists:

List	Description
Scanned Devices	The devices (matched and unmatched) found during the scan.
Matched Devices	The matched DTMs found in the workstation DTM catalog for the device that you selected in the Scanned Devices list. Each time a scanned device is selected in the Scanned Devices list, the contents of the Matched Devices list is updated to display the matched device DTMs found for the selected scanned device. The matching process can yield one or more matched devices for a given scanned device. In this case, only one DTM was discovered for the selected scanned device.
Selected Devices	This list displays the device DTMs that have been selected in the Matched Devices list, which will be added to the Control Expert project.

The lists use the following colored icons:

Color	Meaning
Green	The device has been selected.
Yellow	The device has been matched.
Red	The device has not been matched.
Black	Information about the address of the scanned device: <ul style="list-style-type: none"> ● In the Scanned Devices list, the device has an address identical to one of the DTMs in the Control Expert project ● In the Matched Devices list, the device will be assigned an address identical to one of the DTMs in the Control Expert project
<p>NOTE: An icon can consist of two colors. For example, a search can discover a device that:</p> <ul style="list-style-type: none"> ● has a matching DTM, and ● has an IP address identical to a device already added to the Control Expert application <p>In this case, the icon next to the discovered device would be:</p> <ul style="list-style-type: none"> ● half yellow and half black before it is selected, and ● half green and half black after it is selected 	

This dialog has five buttons:

Button	Use this button to...
Add All 	Automatically add the most closely matched (according to the matching types listed above) device DTM for each found device in the Matched Devices list to the Selected Devices list.
Add One 	Add the matched device DTM selected in the Matched Devices list.
Remove 	Remove one or more devices from the Selected Devices list.
OK	Insert the device DTMs in the Selected Devices list into the Control Expert project. If there are one or more devices in the Selected Devices list that have the same address in the Control Expert project, a message box opens asking if you want to continue. If you click OK , devices in the Control Expert project that have identical addresses as the selected devices are deleted and replaced by the DTMs selected in the Selected Devices list.
Cancel	Cancel the field bus discovery scan and do nothing. Information in the three lists is discarded.

Device Editor

Description

Use the **Device Editor** to view and configure Ethernet communication modules and remote devices. The collection of properties you can view or configure depends on:

- the node type selected in the **DTM Browser**:
 - communication module
 - remote device
- whether Control Expert is operating in **Advanced Mode**

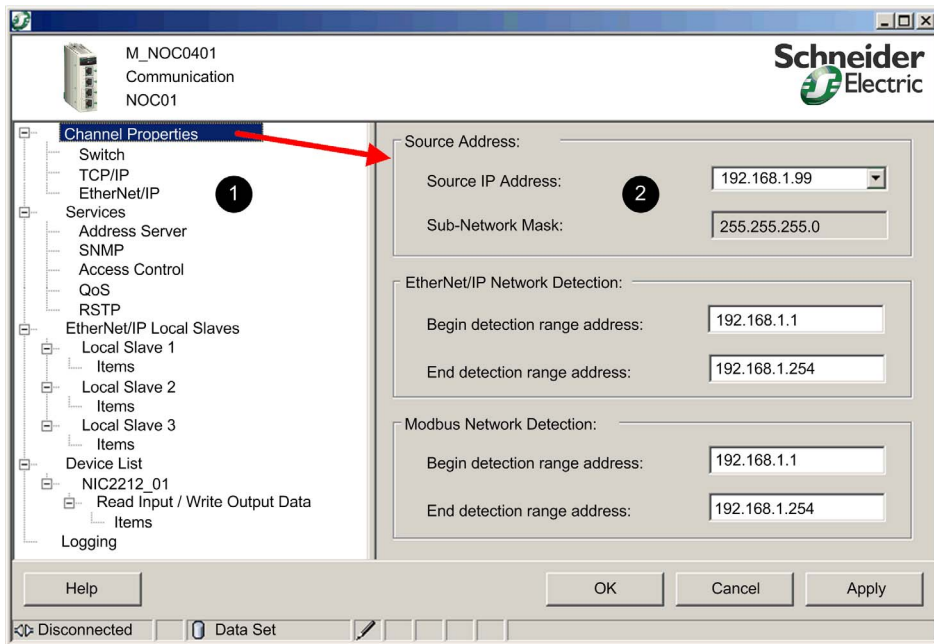

Displaying Properties of the Ethernet Communication Module

After you open the BMX NOC 0401 Ethernet communication module in the **DTM Browser**, the left pane (1, below) of the **Device Editor** displays a tree control containing configurable property groups for the communication module. Click on a node in the tree control to display one or more pages of module properties for the selected group in the right pane (2, below).



Property Types

The **Device Editor** displays an icon next to many device properties. The following three icons are displayed:

This icon...	Indicates the property is...
	Read-only. The property value cannot be edited in this page.
	Read-write. The property value can be edited in this page.
	An expert-level communication protocol property that is displayed only when Advanced Mode is enabled.

Displaying Property Definitions

Many property configuration pages provide an on-screen definition of the property you are editing. To display a property definition in the **Description** section of the page, select that property in the property list. The following screen displays a description of the **Gateway IP Address** property.

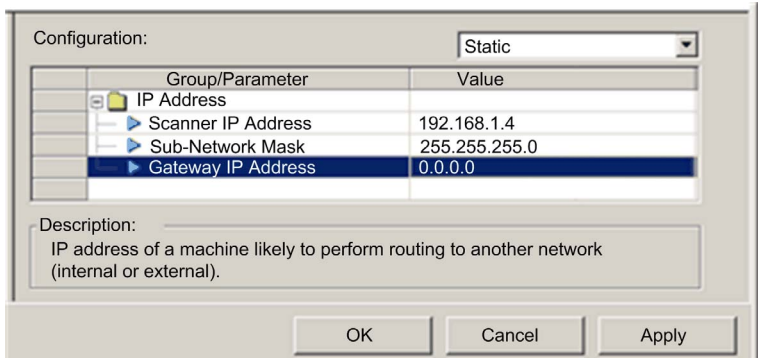

NOTE: The page displayed above can be accessed by opening an Ethernet communication module in the **Device Editor**, and then selecting **Channel Properties** → **TCP/IP** in the navigation tree.

Configuring Properties in the Device Editor



Configuring Properties

The **Device Editor** can be opened from the **DTM Browser**.

To open the **DTM Browser** select **Tools → DTM Browser** in the Control Expert main menu.

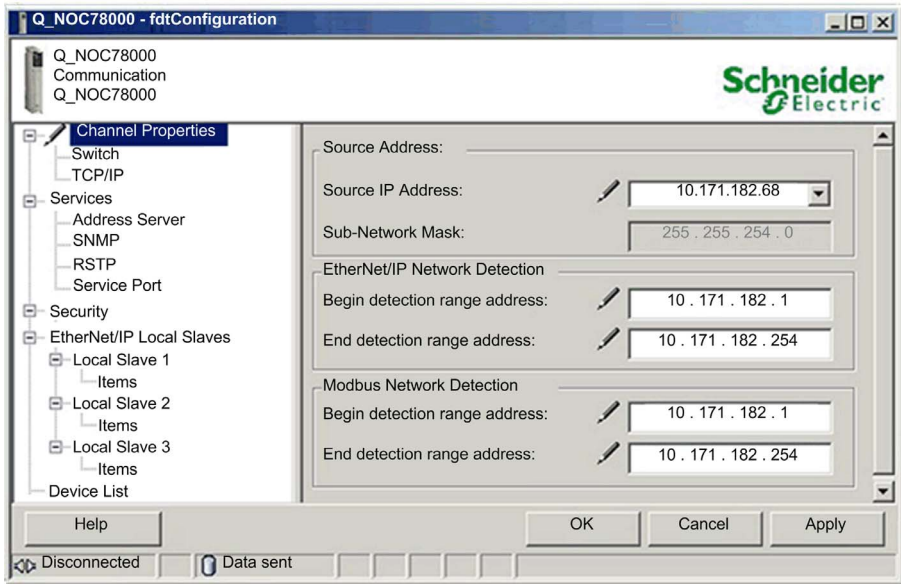
To use the **Device Editor**:

Step	Description
1	Confirm that the DTM you want to use is not connected to the actual communication module or device. If necessary, disconnect the DTM from the module or device (<i>see page 49</i>).
2	In the DTM Browser , select the Ethernet network node you want to configure, which can be either: <ul style="list-style-type: none"> ● an Ethernet communication module — or — ● a remote device
3	<p>With a node selected in the DTM Browser, do one of the following:</p> <ul style="list-style-type: none"> ● In the Control Expert main menu, select Edit → Open. — or — ● In the DTM Browser click the right mouse button and, in the pop-up menu, select Open. <p>The Device Editor appears. It displays the configurable properties for the selected module or device:</p> 
4	Expand the navigation tree and select a node in the left window pane to display its properties in the right pane. The list of configurable properties varies, depending on the node type — communication module or remote device — selected in the DTM Browser .

Step	Description	
5	While you edit a parameter, Control Expert displays an icon — next to the field you are editing and in the navigation tree — indicating the parameter value is being edited. Control Expert displays one of the following icons:	
	This icon...	Indicates the importance of the parameter being edited is...
		High: Editing this parameter may limit or deny access to the module or device.
		Low: Editing this parameter will not limit or deny access to the module or device.
6	<p>After you finish editing a page, click:</p> <ul style="list-style-type: none"> ● Apply to save your edits and keep the page open. — or — ● OK to save your edits and close the page. <p>NOTE: Your edits will not take effect until they are successfully downloaded from your PC to the CPU and from the CPU to the communication modules and network devices.</p>	

Uploading and Downloading DTM-Based Applications

Introduction

You can use Control Expert to download an application file from your PC to the PLC, and to upload an application file from the PLC to your PC.

To perform a successful upload, confirm that the application file includes specific upload-related information as part of the application.

Downloading DTM-Based Applications

Control Expert applications that include DTM files require more memory than traditional Control Expert applications. The following products employ DTMs for network configuration:

- 140 NOC 771 01 Ethernet Communication Module for Quantum
- TSX ETC 101 Ethernet Communication Module for Premium
- BMX NOC 0401 Ethernet Communication Module for M340

In some cases, the configurations created for these modules—and the data associated with them—will require more memory than is available in the CPU.

If the amount of memory required by an application exceeds the amount of memory that is available in the CPU, Control Expert displays a message during the build process, before the application is downloaded to the PLC.

When this situation occurs, exclude the additional upload-related information from the application to complete the build and enable the application download. To do this, make the following configuration change in Control Expert:

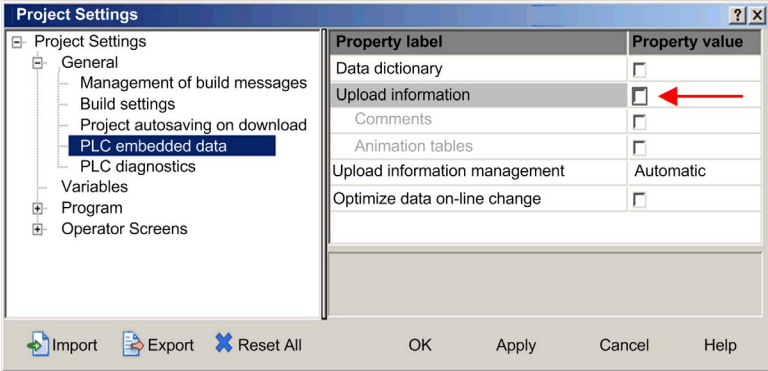
Step	Action														
1	In the main menu, select Tools → Project Settings... The Project Settings window opens.														
2	In the left pane of the Project Settings window, select General → PLC embedded data .														
3	<p>In the right pane, de-select Upload information:</p>  <table border="1" data-bbox="293 412 1061 781"> <thead> <tr> <th>Property label</th> <th>Property value</th> </tr> </thead> <tbody> <tr> <td>Data dictionary</td> <td><input type="checkbox"/></td> </tr> <tr> <td>Upload information</td> <td><input type="checkbox"/></td> </tr> <tr> <td>Comments</td> <td><input type="checkbox"/></td> </tr> <tr> <td>Animation tables</td> <td><input type="checkbox"/></td> </tr> <tr> <td>Upload information management</td> <td>Automatic</td> </tr> <tr> <td>Optimize data on-line change</td> <td><input type="checkbox"/></td> </tr> </tbody> </table>	Property label	Property value	Data dictionary	<input type="checkbox"/>	Upload information	<input type="checkbox"/>	Comments	<input type="checkbox"/>	Animation tables	<input type="checkbox"/>	Upload information management	Automatic	Optimize data on-line change	<input type="checkbox"/>
Property label	Property value														
Data dictionary	<input type="checkbox"/>														
Upload information	<input type="checkbox"/>														
Comments	<input type="checkbox"/>														
Animation tables	<input type="checkbox"/>														
Upload information management	Automatic														
Optimize data on-line change	<input type="checkbox"/>														
4	Click OK to save your changes and close the Project Settings window.														

After the **Upload information** setting is disabled, you can build the application and download it to the PLC.

NOTE: An application in which the **Upload information** setting has been disabled cannot later be uploaded from the PLC to the PC.

Uploading DTM-Based Applications

DTM-based applications that were successfully downloaded to Control Expert—with the project's **Upload information** setting enabled—can later be uploaded from the PLC to the PC if the target PC has the following files installed on it:

- a version of Control Expert that is equal to or higher than the version used to create the application
- the master DTMs for the modules included in the configuration
NOTE: The Ethernet Configuration Tool installation CD contains the Master DTMs for the Ethernet communication modules, referenced above.
- the device DTMs for the DTM-based devices attached to the network (confirm that the DTMs are of the same or higher revision as each device DTM used in the configuration)
- the device EDS files for any EtherNet/IP device used in the configuration (confirm that the EDS files are of the same or higher revision as each device EDS file used in the configuration)

After the above components have been installed on the target PC, you can upload a DTM-based Control Expert application from a PLC.

NOTE: Confirm that each of the above DTM components is installed on the target PC *before* attempting the upload.

Section 2.4

Channel Properties

Overview

This section describes how to configure channel properties for the Ethernet network.

What Is in This Section?

This section contains the following topics:

Topic	Page
Channel Properties Page	63
Channel Properties - Switch Settings	65
Channel Properties - QoS Queue	67
Channel Properties — TCP/IP Page	70
Channel Properties - EtherNet/IP Page	75

Channel Properties Page

Description

Use the **Channel Properties** page to:

- select the IP address to use for:
 - connecting module or device DTMs to physical devices
 - sending explicit messages to Modbus TCP and EtherNet/IP devices
- view your PC's IP address settings

The **Channel Properties** page looks like this:

The screenshot shows a dialog box titled "Channel Properties". It is divided into three main sections, each with a title and a group box:

- Source Address:** Contains a "Source IP Address" dropdown menu set to "192.168.1.99" and a "Sub-Network Mask" text box containing "255.255.255.0".
- EtherNet/IP Network Detection:** Contains a "Begin detection range address" text box with "192.168.1.1" and an "End detection range address" text box with "192.168.1.254".
- Modbus Network Detection:** Contains a "Begin detection range address" text box with "192.168.1.1" and an "End detection range address" text box with "192.168.1.254".

At the bottom of the dialog box are three buttons: "OK", "Cancel", and "Apply".

To display this page, select the **Channel Properties** node in the navigation tree located on the left side of the **Device Editor**.

NOTE: Refer to the topic *Configuring Properties in the Device Editor* ([see page 57](#)) for instructions on how to edit properties.

Properties

This page presents the following properties:

Name	Description
Source Address area:	
Source IP Address (PC):	A list of IP addresses assigned to network interface cards installed on your PC.
Sub-Network Mask:	The subnet mask associated with the selected Source IP Address.
EtherNet/IP Network Detection area:	
Begin detection range address	The starting IP address of the address range for automatic field bus discovery of EtherNet/IP devices.
End detection range address	The ending IP address of the address range for automatic field bus discovery of EtherNet/IP devices.
Modbus TCP Network Detection area:	
Begin detection range address	The starting IP address of the address range for automatic field bus discovery of Modbus TCP devices.
End detection range address	The ending IP address of the address range for automatic field bus discovery of Modbus TCP devices.

Managing Source IP Address for Multiple PCs

When you connect a PC to a DTM-based Control Expert application, Control Expert requires that you define the IP address of the PC connected to the PLC, which is referred to as the *source IP address (PC)*. Rather than having to perform a **Build** in Control Expert each time you connect a PC to the PLC, the source IP address (PC) is selected automatically when you import the Control Expert application. During application import, the DTM retrieves all available configured NIC addresses of a connected PC and matches the subnet mask of the master with the available NIC list.

- If a match between the subnet mask of the master and the NIC list exists, Control Expert automatically selects the matched IP address as the *source IP address (PC)* in the **Channel Properties** page.
- If multiple matches exist, Control Expert automatically selects the IP address nearest to the subnet mask.
- If no match exists, Control Expert automatically selects the IP address to the nearest available subnet mask.

Channel Properties - Switch Settings

Description

Use the **Switch** tab of the **Switch** page to:

- enable or disable each of the four Ethernet ports on the BMX NOC 0401 communication module
- view and edit the **Baud Rate** for each port, which includes both the:
 - transmission speed, and
 - duplex mode

NOTE: The Ethernet communication module supports only the **Ethernet II** frame type.

The **Switch** page looks like this:

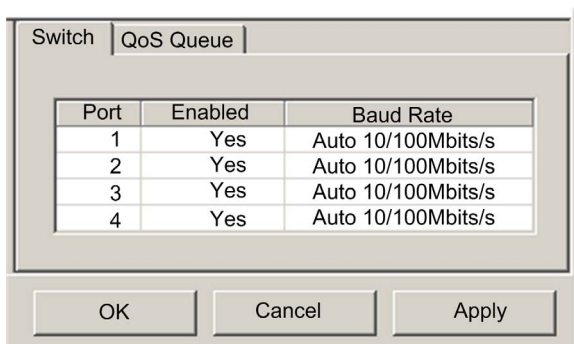

Port	Enabled	Baud Rate
1	Yes	Auto 10/100Mbps/s
2	Yes	Auto 10/100Mbps/s
3	Yes	Auto 10/100Mbps/s
4	Yes	Auto 10/100Mbps/s

OK Cancel Apply

To display this page, select the **Channel Properties** → **Switch** node in the navigation tree located on the left side of the **Device Editor**, then click on the **Switch** tab.

NOTE: Refer to the topic [Configuring Properties in the Device Editor](#) (*see page 57*) for instructions on how to edit properties.

Properties

This page presents the following properties:

Name	Description
Port	(read-only) The Ethernet port number: 1...4.
Enabled	The active status of the port: <ul style="list-style-type: none"> ● Yes = enabled ● No = disabled
Baud Rate	The transmission speed and duplex mode for the network. Values include: <ul style="list-style-type: none"> ● Auto 10/100 Mb (default) ● 100 Mb Half ● 100 Mb Full ● 10 Mb Half ● 10 Mb Full <p>NOTE: Schneider Electric recommends the default setting—Auto 10/100 Mb. This setting causes the connected devices to perform auto-negotiation and thereby determine the fastest common transmission rate and duplex mode.</p>

Channel Properties - QoS Queue

Description

The BMX NOC 0401 Ethernet communication module can be configured to sort packets it receives by placing them into one of 4 separate queues—based upon their priority (very high, high, low, very low)—and handle each packet in the order of its priority.

The module also can be configured to add a *differentiated service code point* (DSCP) value to each packet it originates, indicating the relative priority of the packet.

The process of packet queuing and DSCP tagging together enable the module to perform Ethernet packet traffic management.

Use the **QoS Queue** tab of the **Channel Properties** → **Switch** page to assign *differentiated service code point* (DSCP) values and queueing priorities to Ethernet packets based on their message type.

NOTE:

- The settings input in this page are synchronized with the values input in the **Services** → **QoS** page (*see page 92*). Edits to a common property in either page will change that value in the other page.
- The **Explicit Message** group settings are editable only when Control Expert is operating in **Advanced Mode**.
- Confirm that every switch in your network adopts the same DSCP tagging scheme, thereby providing consistent packet traffic management throughout your network.

The **QoS Queue** page, displaying the default settings, looks like this:

The screenshot shows the 'QoS Queue' configuration page with four sections, each containing a table of traffic types, their DSCP values, and queue mappings.

Precision Time Control

Type of Traffic	DSCP Value	Queue Mapping
PTP Event	59	Very High
PTP General	47	High

EtherNet IP Control

Type of Traffic	DSCP Value	Queue Mapping
Urgent	55	High
Scheduled	47	High
High	43	High
Low	31	Low
Explicit	27	Low

Modbus TCP Control

Type of Traffic	DSCP Value	Queue Mapping
Modbus I/O	47	High
Modbus Explicit	27	Low

Network Time Protocol

Type of Traffic	DSCP Value	Queue Mapping
NTP Control	59	Very High

At the bottom of the page are three buttons: 'OK', 'Cancel', and 'Apply'.

To display this page, select the **Channel Properties** → **Switch** node in the navigation tree located on the left side of the **Device Editor**, then click on the **QoS Queue** tab.

NOTE: Refer to the topic *Configuring Properties in the Device Editor* ([see page 57](#)) for instructions on how to edit properties.

QoS Queue Mapping Settings

DSCP settings have a range of 0...63. The range of **Queue Mapping** settings are set forth below:

Group	Traffic Type	Available Group Queue Settings
Precision Time Control	Point-to-point event	<ul style="list-style-type: none"> ● Very High ● High
	Point-to-point general	<ul style="list-style-type: none"> ● High ● Low ● Very Low
IEtherNet IP Control ¹	Urgent	<ul style="list-style-type: none"> ● High ● Low ● Very Low
	Scheduled	
	High	
	Low	
	Explicit ²	
Modbus TCP Control ¹	Modbus I/O	<ul style="list-style-type: none"> ● High ● Low ● Very Low
	Modbus Explicit	
Network Time Protocol	NTP Control	<ul style="list-style-type: none"> ● Very High ● High ● Low ● Very Low
1. Edits to these properties are synchronized with the Services → QoS page (<i>see page 92</i>). 2. Editable only in Advanced Mode .		

Channel Properties — TCP/IP Page

Description

Use the **TCP/IP** page to:

- select a **Configuration** mode, which specifies how the communication module obtains its IP addressing settings, and
- edit the IP addressing settings that will be used if the **Configuration** mode is set to **Static**

NOTE: The settings made in this page can either match or conflict with the manual settings made using the 2 rotary switches on the back of the module. See the Resolving Conflicting Hardware and Software IP Address Settings topic for an explanation of when IP addressing conflicts exist and how the module resolves them.

The **TCP/IP** page looks like this:

Group/Parameter	Value
IP Address	
▶ Scanner IP Address	192.168.1.4
▶ Sub-Network Mask	255.255.255.0
▶ Gateway IP Address	0.0.0.0

Description:
IP address of a machine likely to perform routing to another network (internal or external).

OK Cancel Apply

To display this page, select the **Channel Properties** → **TCP/IP** node in the navigation tree located on the left side of the **Device Editor**.

NOTE: Refer to the topic Configuring Properties in the Device Editor ([see page 57](#)) for instructions on how to edit properties.

Properties

The IP addressing properties you can configure in this page depends upon the selected configuration mode:

Property	Description	Configuration Mode Options
Scanner IP Address	The 32-bit identifier — consisting of both a network address and a host address — assigned to a device connected to a TCP/IP Internet network using the Internet Protocol (IP).	<ul style="list-style-type: none"> ● Static ● Flash memory ● BOOTP ● DHCP
Sub-Network Mask	The 32-bit value used to hide (or mask) the network portion of the IP address and thereby reveal the host address of a device on a network using the IP protocol.	<ul style="list-style-type: none"> ● Static
Gateway Address	The address of a device, if any, that serves as a gateway to the communication module.	<ul style="list-style-type: none"> ● Static
Name	<p>The device name.</p> <p>NOTE: The default device name, based on the rotary switch settings is BMX_0401_xxy. where:</p> <ul style="list-style-type: none"> ● xx is the value of the upper switch setting (tens) ● y is the value of the lower switch setting (ones) 	<ul style="list-style-type: none"> ● DHCP

Selecting a Configuration Mode

Use the **Configuration** list to specify a configuration mode. The configuration mode setting determines how the communication module obtains its IP address at startup. Choices are:

Configuration Mode	Description
Static	The module uses the scanner IP address, gateway IP address, and sub-network mask configured in this page.
Flash Memory	The module uses the IP address configured via the TCP/IP object and stored flash memory. An IP address configured by this process survives both a warm and a cold re-start.
BOOTP	The module uses an IP address assigned by a BOOTP server.
DHCP ¹	The module uses an IP address assigned by a DHCP server.

Default Address Configurations

The communication module uses a default address configuration when it is not configured or when a duplicate IP address is detected. The default address is based on the MAC address of the module and makes it possible for several Schneider Electric devices to use their default network configuration on the same network.

The module uses the following default address configurations:

- Default IP Address
This default address starts with 10.10 and uses the last two bytes of the MAC address. As an example, a device with the MAC address of 00:00:54:10:8A:05 has a default IP address of 10.10.138.5 (0x8A=138, 0x05=5).
- Default Sub-Network Mask
The default address is 255.0.0.0 (a class A mask).
- Default Gateway Address
The default gateway address is identical to the default IP address.

Duplicate Address Checking

Before going online, the module sends out at least 4 ARP (address resolution protocol) messages with a proposed IP address:

- if an answer is returned:
 - another network device is already using the proposed IP address
 - the module will not use the proposed IP address, but will instead use the default IP address
- if an answer is not returned:
 - the module is assigned the proposed IP address (along with the associated network parameters.)

NOTE: When powering up an entire network, some switches may be slow to complete the power up process. This can cause some ARP messages to be dropped. To help avoid this situation, Schneider Electric recommends that, when powering up an entire network, confirm that every network switch completes its power up cycle before powering up the PLCs.

Resolving Conflicting Hardware and Software IP Address Settings

The following table summarizes the status of the Ethernet channel depending on the **Configuration Mode** set in the application, and the positions of the 2 rotary switches on the back of the module:

Application: Configuration Mode	Rotary Switch Position			
	DHCP ¹	BOOTP	STORED	CLEAR IP
<no configuration>	No Conflict: Get IP address from DHCP server using device name from rotary switches. Start basic services only.	No Conflict: Get IP address from BOOTP server. Start basic services only.	No Conflict: Get IP address from: <ul style="list-style-type: none"> ● flash memory — or — ● BOOTP server — or — ● use default IP address Start basic services only.	No Conflict: Use default IP address. Start basic services only.
Static or Flash memory	Conflict: Get IP address from DHCP server using device name from rotary switches. Start basic services only.	Conflict: Get IP address from BOOTP server. Start basic services only.	No Conflict: Get IP address from the application. Start services configured in the application.	
DHCP or BOOTP with no configured device name	No Conflict: Get IP address from DHCP server using device name from rotary switches. Start services configured in the application.	No Conflict: Get IP address from BOOTP server. Start services configured in the application.	No Conflict: Get IP address from BOOTP server. Start services configured in the application.	
DHCP with a configured device name	Conflict (if device name on switches differs from name in application) or No Conflict: if names are equal. Get IP address from DHCP server using device name from rotary switches. If conflict, start basic services only; If no conflict, start services configured in the application.	Conflict: Get IP address from BOOTP server. Start basic services only.	No Conflict: Get IP address from DHCP server using device name from application. Start services configured in the application.	

1. Based on device name BMX_0401_xxy, where x = the top rotary switch, and y represents the bottom rotary switch.

Basic Services

The following services are provided by the module when it is using its default IP address:

- FTP server (used for firmware download)
- HTTP/Web server
- Modbus/TCP server
- EtherNet/IP explicit message server
- SNMP agent
- RSTP

NOTE: Using the module as a messaging server, when the module is using its default IP address, is not recommended. The module will replace the default IP address with a served or user-configured IP address as soon as one is received.

Channel Properties - EtherNet/IP Page

Description

The **EtherNet/IP** page is displayed only when Control Expert is operating in Advanced Mode (*see page 50*). Advanced mode properties are identified by the  icon.

Use the **EtherNet/IP** page to configure the following communication module properties:

- properties that determine how the communication module, as a scanner, opens connections for both implicit and explicit messages
- the frequency for transmitting produced data over implicit messaging connections
- the timeout period for explicit messaging connections
- the behavior of the communication module—as a scanner—when:
 - the application is stopped, or
 - the communication module receives a reset service request

The **EtherNet/IP** page looks like this:

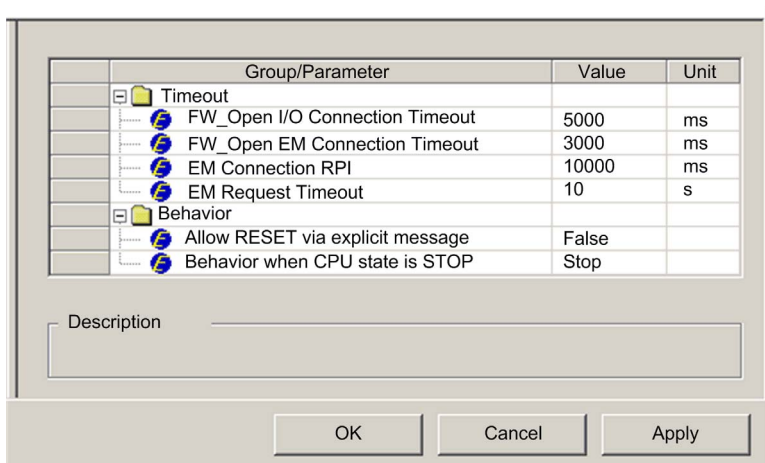

To display this page, select the **Channel Properties** → **EtherNet/IP** node in the navigation tree located on the left side of the **Device Editor**.

NOTE: Refer to the topic *Configuring Properties in the Device Editor* (*see page 57*) for instructions on how to edit properties.

Properties

Note: Users experienced in the configuration of EtherNet/IP networks can edit the following read-write properties.

Name	Description
Timeout	
FW_Open IO Connection Timing	The amount of time the communication module waits for the Forward_Open IO messaging transaction to open an implicit messaging connection. Default = 5000 ms
FW_Open EM Connection Timing	The amount of time the communication module waits for the Forward_Open IO messaging transaction to open an explicit messaging connection. Default = 3000 ms
EM Connected RPI	The value used to set the T->O (target to originator) and O->T (originator to target) requested packet interval (RPI) for explicit message connections. This value is used to calculate the lifetime of a connection. Default = 10000 ms.
EM Request Timeout	The amount of time the communication module waits between a request and reply of an explicit message. Default = 10 s.
Output	
Allow reset explicit message	The behavior of the communication module—as scanner—when it receives a reset service request: <ul style="list-style-type: none"> ● TRUE indicates the module will accept the request and reset itself. ● FALSE indicates the module ignores the reset service request and continues uninterrupted operations. Default = FALSE
Behavior when CPU state is STOP	The state of the communication module when the CPU application goes into a STOP state: <ul style="list-style-type: none"> ● TRUE indicates that the module enters STOP state (implicit connections are closed). ● FALSE indicates that the module enters IDLE state (implicit connections are not closed). Default = FALSE

Section 2.5

Ethernet Services

Overview

This section describes how to enable and configure Ethernet services provided by the BMX NOC 0401 communication module.

What Is in This Section?

This section contains the following topics:

Topic	Page
Enabling Ethernet Services	78
Configuring the DHCP and FDR Servers	80
Configuring the SNMP Agent	86
Configuring Access Control	89
Configuring QoS Ethernet Packet Tagging	92
Configuring the Rapid Spanning Tree Protocol	96
Configuring the Email Service	100
Sending Email via the SEND_EMAIL Block	103
Configuring the Network Time Service	105

Enabling Ethernet Services

Service List

Use the **Services** page to enable and disable Ethernet services provided by the communications module.

NOTE: After you enable any service, you can configure its settings. Control Expert applies default settings to services you enable but elect not to configure.

The **Services** page looks like this:

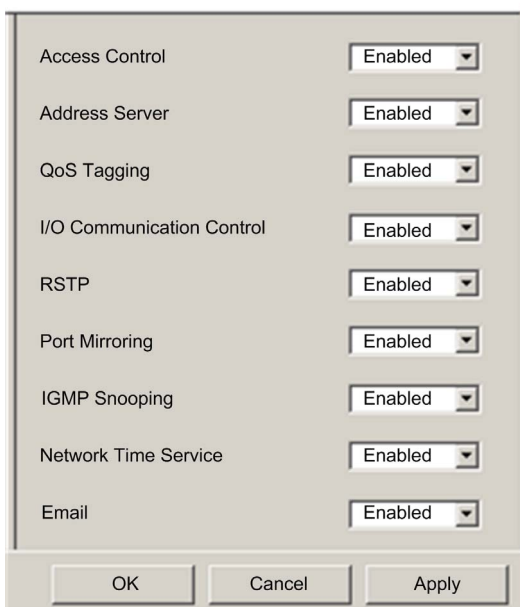

The screenshot shows a configuration window with a list of services and their status. Each service has a dropdown menu currently set to 'Enabled'. At the bottom of the window are three buttons: 'OK', 'Cancel', and 'Apply'.

Access Control	Enabled
Address Server	Enabled
QoS Tagging	Enabled
I/O Communication Control	Enabled
RSTP	Enabled
Port Mirroring	Enabled
IGMP Snooping	Enabled
Network Time Service	Enabled
Email	Enabled

To display this page, select the **Services** node in the navigation tree located on the left side of the **Device Editor**.

After you **Enable** a service in this page, the next step is to configure that service. Depending upon the specific service, it can be configured in either the Control Expert **Device Editor** (by selecting a node beneath the **Services** parent node) or in the module's web pages.

NOTE: Refer to the topic *Configuring Properties in the Device Editor* ([see page 57](#)) for instructions on how to edit properties in Control Expert.

Service Descriptions

The Ethernet communication module can be configured to provide the following services:

This service...	Enables the module to...	Configurable in...
SNMP	<ul style="list-style-type: none"> serve as an SNMP v1 agent provide trap information to up to two devices configured as SNMP managers. <p>NOTE: The SNMP service is enabled by default and cannot be disabled.</p>	(not editable)
Access Control	deny access to the Ethernet communication module from unauthorized devices.	Device Editor
Address Server	provide both IP addressing parameters and operating parameters to other Ethernet devices.	Device Editor
QoS Tagging	<p>add <i>Differentiated Services Code Point</i> (DSCP) tags to Ethernet packets so that network switches can prioritize the transmission and forwarding of Ethernet packets.</p> <p>NOTE: Before enabling QoS tagging, confirm that devices connected to the Ethernet communication module support QoS tagging.</p>	Device Editor
I/O Communication Control	<p>allow the Control Expert application to control the enabling and disabling of individual connections between the communication module and remote I/O devices.</p> <p>NOTE:</p> <ul style="list-style-type: none"> The application can open and close individual connections using the control bits located at the beginning of the output area. If this service is disabled the user—via the application program—cannot toggle on and off connection control bits 	Device Editor
RSTP	employ the <i>rapid spanning tree protocol</i> (RSTP)—in combination with other similarly-configured network devices—to manage redundant physical connections and create a loop-free logical path connecting the network devices.	Device Editor
Port Mirroring	duplicate the traffic entering and exiting any one of the four Ethernet ports onto another non-RSTP destination port, for the purpose of diagnosing the source port.	Web pages
IGMP Snooping	restrict outbound multicast transmissions to only those ports with downstream consumers.	<no configuration required>
Network Time Service	provide the source time synchronization signal for the PLC controller, which manages an internal clock to maintain this time.	Device Editor
Email	enable the sending—but not receiving—of email messages from the PLC application to a standard SMTP server.	Device Editor

Configuring the DHCP and FDR Servers

Description

The Ethernet communication module includes both a DHCP and a Fast Device Replacement (FDR) server. The DHCP server provides IP address settings to networked Ethernet devices. The FDR server provides operating parameter settings to replacement Ethernet devices that are equipped with FDR client functionality.

Use the **Address Server** page to:

- enable and disable the communication module's FDR service
- view an automatically generated list of devices included in the communication module's Ethernet configuration, displaying for each device:
 - IP addressing parameters, and
 - whether the device's IP addressing parameters are provided by the communication module's embedded DHCP server
- manually add remote devices—that are not part of the communication module's Ethernet configuration—to the communication module's DHCP client list

NOTE: Confirm that each device you manually add is equipped with DHCP client software, and is configured to subscribe to the communication module's IP addressing service.

The **Address Server** page looks like this:

The screenshot shows the 'Address Server' configuration interface. At the top, the 'FDR Server' is set to 'Enabled'. Below this, there are two sections for device management:

- Automatically Added Devices:** A table with columns for Device Number, IP Address, DHCP, Identifier Type, Identifier, Sub-Network Mask, and Gateway IP Address. It contains one entry with Device Number 003, IP Address 192.168.1.6, DHCP Enabled, Identifier Type Device Name, Identifier NIC2212_01, Sub-Network Mask 255.255.255.0, and Gateway IP Address 0.0.0.0.
- Manually Added Devices:** A table with columns for IP Address, Identifier Type, Identifier, Sub-Network Mask, and Gateway IP Address. It contains one entry with IP Address 192.169.0.23, Identifier Type Device Name, Identifier NIC2212_24, Sub-Network Mask 255.255.255.0, and Gateway IP Address 192.169.0.0. To the right of this table are buttons for 'Add Device Manually' and 'Remove'.

At the bottom of the interface are three buttons: 'OK', 'Cancel', and 'Apply'.

To display this page:

Step	Description
1	Select the Services node in the navigation tree located on the left side of the Device Editor . The Services page opens.
2	In the Services page, set the Address Server field to Enabled . The Address Server node appears in the navigation tree.
3	Select the Address Server node in the navigation tree.

Enabling the FDR Service

To enable the communication module's FDR service, set the **FDR Server** field to **Enabled**. To disable the service, toggle the same field to **Disabled**.

NOTE: Refer to the topic *Configuring Properties in the Device Editor* ([see page 57](#)) for instructions on how to apply edited properties to networked devices.

Any networked Ethernet device equipped with FDR client functionality can subscribe to the communication module's FDR service. The communication module can store up to 1 MB of FDR client operating parameter files. When this file storage capacity is reached, the module cannot store any additional client FDR files.

The communication module can store FDR client files for up to 128 devices, depending on the size of each stored file. For example, if the size of each FDR client file is small—not more than 8 Kb—the module could store up to the maximum of 128 parameter files.

Manually Adding Remote Devices to the DHCP Service

Remote devices that are part of the communication module's Ethernet configuration—and which have subscribed to the communication module's IP addressing service—automatically appear in the **Automatically Added Devices** list.

Other remote devices—that are not part of the communication module's configuration—can be manually added to the communication module's DHCP IP addressing service.

To manually add networked Ethernet devices, which are not part of the communication module's Ethernet configuration, to the communication module's IP addressing service:

Step	Description										
1	In the Address Server page, click the Add Device Manually button. Control Expert adds an empty row to the list of Manually Added Devices .										
2	In the new row, configure the following parameters for the client device: <table border="1"> <tbody> <tr> <td>IP Address</td> <td>Type in the IP address of the client device.</td> </tr> <tr> <td>Identifier Type</td> <td>Select the type of value the client device will use to identify itself to the FDR server: <ul style="list-style-type: none"> ● MAC address ● Device Name </td> </tr> <tr> <td>Identifier</td> <td>Depending upon the identifier type, type in the client device setting for the MAC address or Name.</td> </tr> <tr> <td>Mask</td> <td>Type in the client device subnet mask.</td> </tr> <tr> <td>Gateway</td> <td>Type in the gateway address that remote devices can use to communicate with devices located on other networks. Use 0.0.0.0 if remote devices will not communicate with devices located on other networks.</td> </tr> </tbody> </table>	IP Address	Type in the IP address of the client device.	Identifier Type	Select the type of value the client device will use to identify itself to the FDR server: <ul style="list-style-type: none"> ● MAC address ● Device Name 	Identifier	Depending upon the identifier type, type in the client device setting for the MAC address or Name.	Mask	Type in the client device subnet mask.	Gateway	Type in the gateway address that remote devices can use to communicate with devices located on other networks. Use 0.0.0.0 if remote devices will not communicate with devices located on other networks.
IP Address	Type in the IP address of the client device.										
Identifier Type	Select the type of value the client device will use to identify itself to the FDR server: <ul style="list-style-type: none"> ● MAC address ● Device Name 										
Identifier	Depending upon the identifier type, type in the client device setting for the MAC address or Name.										
Mask	Type in the client device subnet mask.										
Gateway	Type in the gateway address that remote devices can use to communicate with devices located on other networks. Use 0.0.0.0 if remote devices will not communicate with devices located on other networks.										
3	Refer to the topic <i>Configuring Properties in the Device Editor</i> (see page 57) for instructions on how to apply edited properties to networked devices.										

Viewing the Auto-Generated DHCP Client List

The list of **Automatically Added Devices** includes a row for each remote device that is:

- part of the communication module's Ethernet configuration, and
- configured to subscribe to the communication module's DHCP addressing service

NOTE: You cannot add devices to this list in this page. Instead, use the configuration pages for the remote device to subscribe to this service.

The list of **Automatically Added Devices** contains the following information for each networked device:

Property	Description
Device Number	The number assigned to the device in the Control Expert configuration.
IP Address	The client device IP address.
Enable DHCP	TRUE indicates that the device subscribes to the DHCP service.

Property	Description
Identifier Type	Indicates the mechanism used by the server to recognize the client (MAC address or DHCP device name).
Identifier	The actual MAC address or DHCP device name.
Mask	The client device subnet mask.
Gateway	The IP address a DHCP client device will use to access other devices that are not located on the local subnet. A value of 0.0.0.0 constrains the DHCP client device by allowing it to communicate only with devices on the local subnet.

Subscribing to the DHCP Service for a Device that is Part of the Configuration

An Ethernet device—that is part of the communication module Ethernet configuration—can subscribe to the communication module’s IP addressing service. To subscribe to this service, follow these steps:

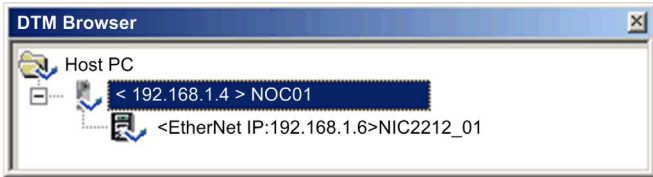
Step	Action
1	<p>In the DTM Browser, select the Ethernet communication module that is connected to the remote device that you want to add to the DHCP service. In the following example, the communication module with the alias name of NOC01 is selected:</p>  <p>NOTE: The selected module is connected to the STB NIC 2212 network interface device bearing the alias name NIC2212_01, which is the module you want to add to the DHCP service.</p>

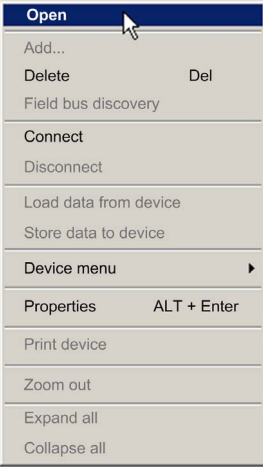
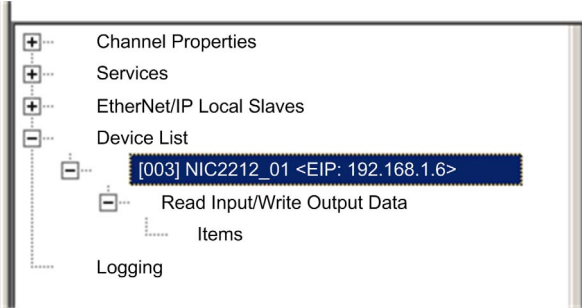
Step	Action
2	<p>With NOC01 selected in the DTM Browser, click the right mouse button, and select Open in the pop-up menu.:</p>  <p>The Device Editor opens.</p>
3	<p>In the navigation tree on the left side of the Device Editor, expand the Device List node and select the device for which you want to enable the DHCP service. In this example, select NIC2212_01:</p>  <p>Control Expert displays the properties for the selected remote device in the right pane of the window.</p>

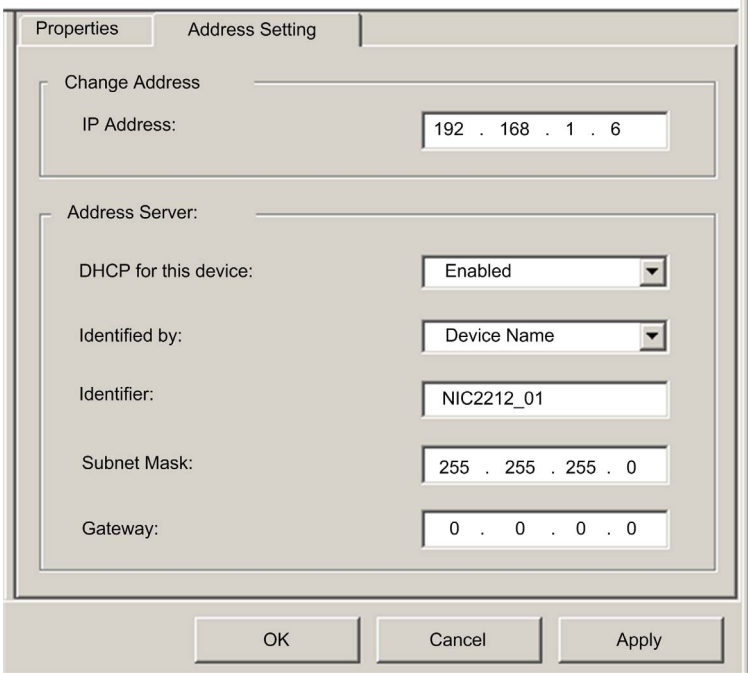
Step	Action										
4	<p>In the right pane of the window, select the Address Setting tab to display the following page:</p> 										
5	<p>In the Address Server area of this page, configure the following properties:</p> <table border="1" data-bbox="310 964 1251 1377"> <tbody> <tr> <td data-bbox="310 964 646 1000">DHCP for this device</td> <td data-bbox="646 964 1251 1000">Select Enabled</td> </tr> <tr> <td data-bbox="310 1000 646 1133">Identified by</td> <td data-bbox="646 1000 1251 1133"> The choices are: <ul style="list-style-type: none"> ● MAC Address, or ● Device Name Select Device Name. </td> </tr> <tr> <td data-bbox="310 1133 646 1224">Identifier</td> <td data-bbox="646 1133 1251 1224">Control Expert has automatically added the device name NIC2212_01. For the purpose of this example, accept this default value.</td> </tr> <tr> <td data-bbox="310 1224 646 1312">Subnet Mask</td> <td data-bbox="646 1224 1251 1312">Control Expert has automatically applied the same subnet mask used for the Ethernet communication module. For the purpose of this example, accept the default value of 255.255.255.0.</td> </tr> <tr> <td data-bbox="310 1312 646 1377">Gateway</td> <td data-bbox="646 1312 1251 1377">For the purpose of this example, accept the default value of 0.0.0.0.</td> </tr> </tbody> </table>	DHCP for this device	Select Enabled	Identified by	The choices are: <ul style="list-style-type: none"> ● MAC Address, or ● Device Name Select Device Name .	Identifier	Control Expert has automatically added the device name NIC2212_01 . For the purpose of this example, accept this default value.	Subnet Mask	Control Expert has automatically applied the same subnet mask used for the Ethernet communication module. For the purpose of this example, accept the default value of 255.255.255.0 .	Gateway	For the purpose of this example, accept the default value of 0.0.0.0 .
DHCP for this device	Select Enabled										
Identified by	The choices are: <ul style="list-style-type: none"> ● MAC Address, or ● Device Name Select Device Name .										
Identifier	Control Expert has automatically added the device name NIC2212_01 . For the purpose of this example, accept this default value.										
Subnet Mask	Control Expert has automatically applied the same subnet mask used for the Ethernet communication module. For the purpose of this example, accept the default value of 255.255.255.0 .										
Gateway	For the purpose of this example, accept the default value of 0.0.0.0 .										
6	<p>Click OK to save your edits.</p> <p>NOTE: Refer to the topic Configuring Properties in the Device Editor (<i>see page 57</i>) for more information on editing and saving property settings in this window.</p>										

Configuring the SNMP Agent

Description

The Ethernet communication module includes an SNMP v1 agent. An SNMP agent is a software component running on the communication module that allows access to the module's diagnostic and management information via the SNMP service.

SNMP browsers, network management software, and other tools typically use SNMP to access this data. In addition, the SNMP agent can be configured with the IP address of up to two devices—typically PC's running network management software—to be the target of event driven trap messages. These trap messages inform the management device of events such as cold start, and detected authentication failures.

Use the **SNMP** page to configure the SNMP agent in the communication module. The SNMP agent can connect to and communicate with up to 2 SNMP managers as part of an SNMP service. The SNMP service includes:

- authentication checking, by the Ethernet communication module, of any SNMP manager that sends SNMP requests
- management of event, or trap, reporting by the module

The **SNMP** page looks like this:

Group/Parameter	Value	Unit
IP Address Managers		
IP Address Manager 1	0.0.0.0	
IP Address Manager 2	0.0.0.0	
Agent		
Location (SysLocation)		
Contact (SysContact)		
SNMP Manager	False	
Community Names		
Set	Public	
Get	Public	
Trap	Public	
Security		
Enable "Authentication Failure" Trap	False	

Description

OK Cancel Apply

To display this page:

Step	Description
1	Select the Services node in the navigation tree located on the left side of the Device Editor . The Services page opens.
2	In the Services page, set the SNMP field to Enabled , then click OK or Apply . The SNMP node appears in the navigation tree.
3	Select the SNMP node in the navigation tree.

NOTE: Refer to the topic *Configuring Properties in the Device Editor* ([see page 57](#)) for instructions on how to edit properties.

Viewing and Configuring SNMP Properties

NOTE: The sysName SNMP parameter is neither editable nor visible in the Control Expert Ethernet Configuration Tool software. By default, the sysName is set to the Ethernet communication module part number.

When DHCP is enabled and **Device Name** is selected as the DHCP identifier for the module, the SNMP sysName parameter is not set to the module part number, but is instead the device name.

The following properties can be viewed and edited in the **SNMP** page:

Property	Description
IP Address Managers:	
IP Address Manager 1	The IP address of the first SNMP manager to which the SNMP agent sends notices of traps.
IP Address Manager 2	The IP address of the second SNMP manager to which the SNMP agent sends notices of traps.
Agent:	
Location	The device location (32 characters maximum)
Contact	Information describing the person to contact for device maintenance (32 characters maximum)
SNMP Manager	Select either: <ul style="list-style-type: none"> ● TRUE: the Location and Contact information are editable in this page ● FALSE: Location and Contact settings are not editable in this page
Community Names:	
Get	Password required by the SNMP agent before executing read commands from an SNMP manager. Default = public .
Set	Password required by the SNMP agent before executing write commands from an SNMP manager. Default = public
Trap	Password an SNMP manager requires from the SNMP agent before the manager will accept trap notices from the agent. Default = public

Property	Description
Security:	
Enable Authentication Failure Trap	TRUE causes the SNMP agent to send a trap notification message to the SNMP manager if an unauthorized manager sends a Get or Set command to the agent. Default = FALSE .

Configuring Access Control

Description

Use the **Access Control** page to restrict access to the Ethernet communication module in its role as either a Modbus TCP or EtherNet/IP server. When access control is enabled in the **Services** page, add the IP addresses of the following devices to the list of **Authorized Addresses** to permit communication with that device:

- the Ethernet communication module itself, so that the module can use EtherNet/IP explicit messaging for any of the following purposes:
 - obtaining diagnostic data
 - resetting the module
 - changing the IP address
- any client device that may send a request to the Ethernet communication module, in its role as either Modbus TCP or EtherNet/IP server
- your own maintenance PC, so that you can communicate with the PLC via Control Expert to configure and diagnose your application, and to view the module's web pages
- any target device to which the Ethernet communication module may send a Modbus TCP explicit message

NOTE: You need not add to list the IP address of devices that will be the target of EtherNet/IP explicit messages.

When access control is disabled in the **Services** page, the Ethernet communication module will accept Modbus TCP and EtherNet/IP requests from any device.

The following graphic depicts the **Access Control** page immediately after a new row has been added to the list of **Authorized Addresses**, but before the new item has been configured:

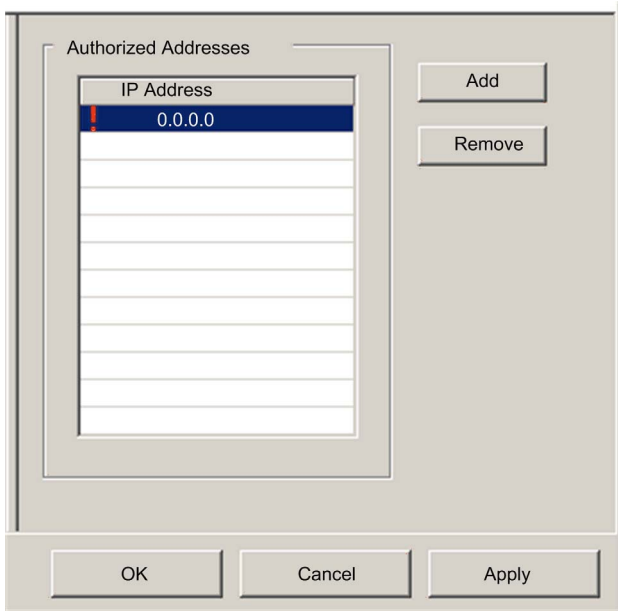

To display this page:

Step	Description
1	Select the Services node in the navigation tree located on the left side of the Device Editor . The Services page opens.
2	In the Services page, set the Access Control field to Enabled and click either OK or Apply . The Access Control node appears in the navigation tree.
3	Select the Access Control node in the navigation tree.

NOTE: Refer to the topic *Configuring Properties in the Device Editor* ([see page 57](#)) for instructions on how to edit properties.

Adding and Removing Devices in the Authorized Address List

To add a device to the **Authorized Addresses** list:

Step	Description
1	In the Access Control page, click Add . A new row appears in the Authorized Addresses list, displaying: <ul style="list-style-type: none">• a red exclamation point, indicating editing has begun, and• a placeholder IP address of 0.0.0.0
2	Double-click the left mouse button on the placeholder IP address. The IP address field expands and becomes editable.
3	In the new IP address field, type in the IP address of the device which will be able to access the communication module, then press Enter .
4	Repeat steps 1 through 3, above, for each additional device to which you want to grant access to the communication module.
5	Refer to the topic <i>Configuring Properties in the Device Editor</i> (see page 57) for instructions on how to save your configuration edits.

To remove a device from the **Authorized Addresses** list, select its IP address in the list, then click **Remove**. The selected IP address is removed.

Configuring QoS Ethernet Packet Tagging

Description

The Ethernet communication module can be configured to perform Ethernet packet tagging. The module supports the OSI layer 3 Quality of Service (QoS) standard defined in RFC-2475. When you enable QoS, the module adds a *differentiated services code point* (DSCP) tag to each Ethernet packet it transmits, thereby indicating the priority of that packet.

Use the **QoS** page to:

- specify the source of QoS packet priority settings, and
- view or edit QoS DSCP prioritization values

The contents of the **QoS** page depends on the Ethernet communication module you selected for your project: **BMX NOC 0401** or **BMX NOC 0401.2**.

NOTE: The DSCP Value settings input in the **QoS** page are synchronized with the same settings in the **QoS Queue** tab of the **Channel Properties → Switch** page. Edits to a common property in either page will change that value in the other page.

The **QoS** page displays five EtherNet/IP traffic types when you are operating in **Advanced Mode** (*see page 50*), or two EtherNet/IP traffic types when Advanced Mode is de-selected.

To display the **QoS** page:

Step	Description
1	Select the Services node in the navigation tree located on the left side of the Device Editor . The Services page opens.
2	In the Services page, set the QoS Tagging field to Enabled , then click OK or Apply . The QoS node appears in the navigation tree.
3	Select the QoS node in the navigation tree.

NOTE: Refer to the topic *Configuring Properties in the Device Editor* (*see page 57*) for instructions on how to edit properties.

The QoS Page for the BMX NOC 0401.2 Ethernet Communication Module

The following **QoS** page displays the default values for the **BMX NOC 0401.2** module displays when operating in **Advanced Mode**:

Use Value from: Configuration

EtherNet/IP Traffic

DSCP Value for I/O Data Scheduled Priority Messages	47
DSCP Value for Explicit Messages	27
DSCP Value for I/O Data Urgent Priority Messages	55
DSCP Value for I/O Data High Priority Messages	43
DSCP Value for I/O Data Low Priority Messages	31

Modbus TCP Traffic

DSCP Value for I/O Messages	47
DSCP Value for Explicit Messages	27

Network Time Protocol Traffic

DSCP Value for Network Time Protocol Messages	59
---	----

OK Cancel Apply

The QoS Page for the BMX NOC 0401 Ethernet Communication Module

The following **QoS** page displays the default values for the **BMX NOC 0401** module displays when operating in **Advanced Mode**:

Use Value from: Configuration

Type of Traffic

DSCP Value for I/O Data Urgent Priority Messages (EtherNet/IP):	55
DSCP Value for I/O Data Scheduled Priority Messages (EtherNet/IP):	47
DSCP Value for I/O Data High Priority Messages (Modbus/TCP - EtherNet/IP):	43
DSCP Value for I/O Data Low Priority Messages (EtherNet/IP):	31
DSCP Value for Explicit Message (Modbus/TCP - EtherNet/IP):	27

OK Cancel Apply

Specifying the Source of QoS Settings

The five QoS prioritization values can be set either from the communication module's flash memory, or in this page. To specify the QoS configuration source, set the **Use value from** field to either:

Setting	Description
Configuration ¹	The communication module uses the settings input in the Type of Traffic section of this page.
Flash ¹	The communication module uses the settings saved in the module's flash memory. The fields in the Type of Traffic section are read-only.

1. Schneider Electric recommends that QoS values be set in the configuration, and not by saving settings to flash memory. Settings saved to flash memory will be lost if the module is replaced.

NOTE: You can also edit QoS configuration settings by using explicit messages to set the attributes of the QoS CIP object ([see page 253](#)).

Type of Traffic Settings

QoS tagging lets you prioritize Ethernet packet streams based on the type of traffic in that stream. The communication module recognizes the traffic types described below. When the **Use value from** field is set to **Configuration**, you can edit the prioritization values in this page. Each traffic type can have a prioritization value from 0... 63.

Traffic Type	Default
DSCP Value for IO Data Scheduled Priority Messages (EtherNet/IP)	43
DSCP Value for Explicit Message (Modbus TCP & EtherNet/IP)	27
DSCP Value for IO Data Urgent Priority Messages (EtherNet/IP) ¹	55
DSCP Value for IO Data High Priority Messages (Modbus TCP & EtherNet/IP) ¹	43
DSCP Value for IO Data Low Priority Messages (EtherNet/IP) ¹	31
DSCP Value for Network Time Protocol Messages	59
1. Visible only when Advanced Mode (<i>see page 50</i>) is enabled.	

To effectively implement QoS settings in your Ethernet network:

- use network switches that support QoS
- consistently apply DSCP values to network devices and switches that support DSCP
- verify that switches apply a consistent set of rules for sorting DSCP tags, when transmitting and receiving Ethernet packets

NOTE: The QoS settings for Scheduled, High, and Low priority messages also apply to input and output priority messages for a remote device. You can configure these settings for a remote device (*see Quantum using EcoStruxure™ Control Expert, 140 NOC 771 01 Ethernet Communication Module, User Manual*) in the **Device Editor** by selecting a device connection node, then opening the connection's **General** page.

Configuring the Rapid Spanning Tree Protocol

Description

Ethernet ports 3 and 4, located on the front of the BMX NOC 0401 communication module, support the *Rapid Spanning Tree Protocol* (RSTP). RSTP is an OSI layer 2 protocol defined by IEEE 802.1D 2004. RSTP performs two necessary services:

- it creates a loop-free logical network path for Ethernet devices that are part of a topology that includes redundant physical paths
- it automatically restores network communication—by activating redundant links—in the event the network experiences a loss of service

RSTP software, operating simultaneously in every network switch, obtains information from each switch which enables the software to create a hierarchical logical network topology. RSTP is a flexible protocol that can be implemented on many physical topologies, including ring, mesh, or a combination of ring and mesh.

Use the **RSTP → General** and the **RSTP → Advanced** pages to configure RSTP for the embedded Ethernet switch in the communication module.

NOTE: RSTP can be implemented only when every network switch is configured to support RSTP.

The **RSTP → General** page looks like this:

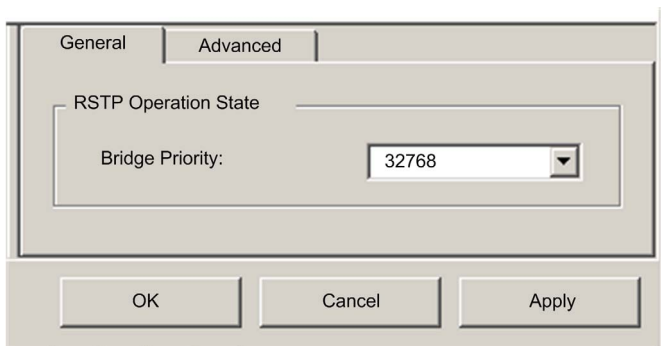

The image shows a configuration dialog box for RSTP. It has two tabs: "General" (selected) and "Advanced". Under the "General" tab, there is a section titled "RSTP Operation State". Inside this section, there is a label "Bridge Priority:" followed by a text input field containing the value "32768" and a small downward-pointing arrow on the right side. At the bottom of the dialog box, there are three buttons: "OK", "Cancel", and "Apply".

The **RSTP** → **Advanced** page looks like this:

The screenshot displays the RSTP Advanced configuration page, which is divided into three main sections: Bridge Parameters, Port Parameters, and Port 4 Parameters. At the top, there are two tabs: 'General' and 'Advanced', with 'Advanced' being the active tab. The Bridge Parameters section includes three input fields: 'Maximum Age Time' set to 20 s, 'Transmit Hold Count' set to 40 Times, and 'Hello Time' set to 2 s. The Port Parameters section is further divided into 'Port 3 Parameters' and 'Port 4 Parameters'. Both sections have identical settings: 'RSTP' is set to 'Enabled', 'Priority' is 0, 'RTP Cost' is 'Auto' with a 'Value' of 'N/A', 'Edge Port' is 'Auto', and 'Point to Point' is 'Auto'. At the bottom of the window, there are three buttons: 'OK', 'Cancel', and 'Apply'.

Section	Parameter	Value
Bridge Parameters	Maximum Age Time	20 s
	Transmit Hold Count	40 Times
	Hello Time	2 s
Port Parameters	Port 3 Parameters	
	RSTP	Enabled
	Priority	0
	RTP Cost	Auto
	Value	N/A
	Edge Port	Auto
Point to Point	Auto	
Port 4 Parameters		
RSTP	Enabled	
Priority	0	
RTP Cost	Auto	
Value	N/A	
Edge Port	Auto	
Point to Point	Auto	

To display these pages:

Step	Description
1	Select the Services node in the navigation tree located on the left side of the Device Editor . The Services page opens.
2	In the Services page, set the RSTP field to Enabled , then click OK or Apply . The RSTP node appears in the navigation tree.
3	Select the RSTP node in the navigation tree, then click on either the General or Advanced tab to display that page.

NOTE: Refer to the topic *Configuring Properties in the Device Editor* (*see page 57*) for instructions on how to edit properties.

Configuring RSTP Properties

The following properties can be viewed and edited in the **RSTP → General** page:

Property	Description
RSTP Operation State: Bridge Priority	A 2-byte value for the switch, from 0 to 65535, with a default of 32768 (the midpoint). NOTE: Network switches running RSTP software periodically exchange information about themselves using special packets called Bridge Protocol Data Units (BPDUs), which act as a heartbeat. The Bridge Priority value is contained in the BPDU and establishes the relative position of the switch in the RSTP hierarchy.

The following properties can be viewed and edited in the **RSTP → Advanced** page:

Property	Description
Bridge Parameters:	
Maximum Age Time	This value is set to The length of time, from 6 to 40 seconds, that the switch waits for receipt of the next hello message, before initiating a change to the RSTP topology. Default = 40 s.
Transmit Hold Count	The maximum number of BPDUs, from 1 to 40, that the switch can transmit per second. Default = 40.
Hello Time	(read-only) The frequency—set at 2 seconds—that the embedded switch sends heartbeat BPDUs.

Property	Description
Port Parameters (These properties can be separately configured for ports 3 and 4):	
RSTP	(read-only) This property is set to Enabled in the Services page.
Priority	<p>The priority assigned to the switch port, an integer from 0 to 240 in increments of 16. Default = 0. This value is used by the RSTP process if it needs to break a tie between two ports on the same switch when identifying a:</p> <ul style="list-style-type: none"> ● root port: the port on a non-root switch that is closest to the root bridge in terms of path cost, or ● designated port: the port at one end of a network segment through which traffic passes on its way to the root bridge
RSTP Cost	<p>The method used to determine the RSTP cost of the path through the embedded switch. Values include:</p> <ul style="list-style-type: none"> ● Auto—the RSTP protocol will automatically assign a value to the switch by operation of the RSTP algorithm ● Manual—you input the RSTP cost—an integer from 1 to 200000000—in the Value field.
Edge Port	(read-only) Set to a fixed value of Auto . The RSTP process automatically determines if the port is an RSTP edge port.
Point to Point	(read-only) Set to a fixed value of Auto . The RSTP process automatically determines if the port is an RSTP point-to-point port.

Configuring the Email Service

Using the Email Service

Use the Simple Mail Transfer Protocol (SMTP) service to configure up to three (3) Email messages. The PLC uses the Email messages you configure to notify specified Email recipients about meaningful run-time events—for example, a change in the value of a variable, or a threshold overrun.

NOTE: The Email service is available only when you first perform the following tasks:

- upgrade the firmware in the **BMX NOC 0401** Ethernet communication module to version 2.01 or higher.
- select the **BMX NOC 0401.2** Ethernet communication module for your project using Unity Pro version 7.0 or higher.

NOTE: Unity Pro is the former name of Control Expert for version 13.1 or earlier.

Email messages are transmitted by the execution of a `SEND_EMAIL` (*see page 103*) function block included in your application logic.

NOTE: To successfully send an Email message using the `SEND_EMAIL` block, the Email service and PLC application must be synchronized—i.e., the Email service must be activated whenever the PLC is in RUN mode.

You can configure the Email service only in the **Email Configuration** page of Control Expert. You can diagnose the operation of the Email service in the diagnostic pages of both the Control Expert software (*see page 328*) and the communication module web pages (*see page 391*).

Configuring Email Service Parameters

Use the following page to configure up to three Email messages:

SMTP Server Configuration

SMTP Server IP Address: SMTP Server Port:

Password Authentication

Authentication: Login:
 Password:

Email Header 1

From:
 To:
 Subject:

Email Header 2

From:
 To:
 Subject:

Email Header 3

From:
 To:
 Subject:

To display this page:

Step	Description
1	Select the Services node in the navigation tree located on the left side of the Device Editor . The Services page opens.
2	In the Services page, set the Email field to Enabled . The Email node appears in the navigation tree.
3	Select the Email node in the navigation tree.

Viewing and Configuring Email Settings

The configurable Email service parameters include the following:

Parameter	Description
SMTP Server Configuration:	
SMTP Server IP Address:	The IP address of the Email server that will relay Email messages.
SMTP Server Port:	TCP port used by the Email server. Default = 25.
Password Authentication:	
Authentication:	Is client authentication by the Email server: <ul style="list-style-type: none">● Disabled (default)● Enabled
Login:	If the Email server is configured for client authentication, the user name, up to 64 characters.
Password:	If the Email server is configured for client authentication, the client password string, up to 64 characters.
Email Header 1...3:	
From:	The Email address of the sender, up to 64 characters.
To:	The Email addresses of the recipients, up to 128 characters.
Subject:	The static part of the Email message, up to 32 characters.

Sending Email via the SEND_EMAIL Block

Using SEND_EMAIL to Send Pre-configured Email Messages

Use the `SEND_EMAIL` block in your application to programmatically send any of three email messages you previously configured in Control Expert (*see page 100*).

NOTE: To successfully send an Email message using the `SEND_EMAIL` block, synchronize the Email client service and PLC application—i.e., activate the Email client service whenever the PLC is in RUN mode.

FBD Representation

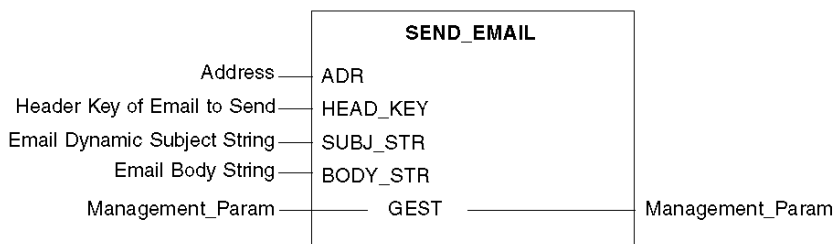

Input Parameters

The following table describes the input parameters:

Parameters	Data Type	Description
ADR	ARRAY [0...7] OF INT	The path to the destination device, in the format of <i>rack.slot.channel</i> . Use the EFB ADDR to convert from the string format to the array of INT. For example, if the module is configured at rack 0, slot 4, channel 0, use: ADDR('0.4.0').
HEAD_KEY	INT	The email header number previously configured in Control Expert (<i>see page 100</i>). Only values of 1, 2, and 3 are valid).
SUBJ_STR	STRING	The dynamic part of the email subject that is appended to the static subject string.
BODY_STR	STRING	The body of the email. NOTE: Use the \$N (or \$n) two-character tag to insert a line break in the email text.

Input / Output Parameters

The following table describes the `GEST` management parameter, which is the only input/output parameter:

Parameters	Data Type	Description
GEST	ARRAY [0...3] OF INT	The management parameter, consisting of 4 words.

The `GEST` management parameter presents the following structure:

Description	Word Order	MSB	LSB
System-managed data	1	Exchange number	Activity bit—the first bit of the first word. It indicates the execution status of the communication: <ul style="list-style-type: none"> ● 1 = Email is being sent ● 0 = Email complete
	2	Operation report <i>(see page 424)</i>	Communication report <i>(see page 423)</i>
User-managed data	3	Timeout	
	4	Length: the size of the data buffer. NOTE: The length parameter is an output parameter. This word is written by the system and equals the total length of the email (header + body). The maximum size of header + body is 1024 characters.	

Configuring the Network Time Service

The Network Time Protocol Client

The Ethernet communication module includes a network time protocol (NTP) client. After you enable the network time service (*see page 78*), you can configure it by:

- identifying two external NTP servers—a primary server, and a secondary server—the Ethernet communication module uses to synchronize its internal time setting
- specifying the time zone location of the module
- enabling the automatic adjustment of the module internal time setting for daylight saving time changes

The Ethernet communication module sends its internal time setting to the PLC controller over the shared backplane. The PLC manages an internal clock to maintain this time, and uses the time setting to time-stamp system events and I/O data.

NOTE: The network time service is available only when you first perform the following tasks:

- upgrade the firmware in the **BMX NOC 0401** Ethernet communication module to version 2.01 or higher
- select the **BMX NOC 0401.2** Ethernet communication module for your project using Unity Pro version 7.0 or higher

NOTE: Unity Pro is the former name of Control Expert for version 13.1 or earlier.

Operation of the network time service can be monitored and diagnosed in:

- the Network Time Service Diagnostics page of the Control Expert software (*see page 341*), and
- the Network Time Service web page (*see page 414*)

You can configure the network time only in the following page:

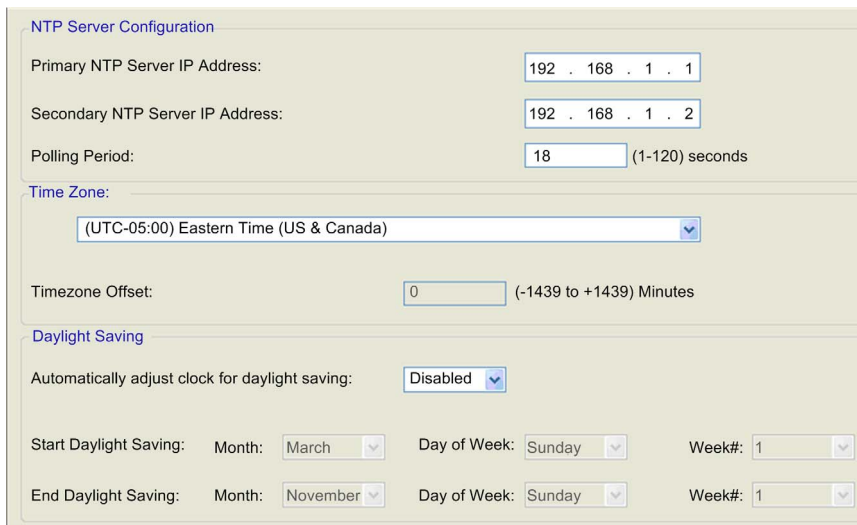

NTP Server Configuration

Primary NTP Server IP Address: 192 . 168 . 1 . 1

Secondary NTP Server IP Address: 192 . 168 . 1 . 2

Polling Period: 18 (1-120) seconds

Time Zone:

(UTC-05:00) Eastern Time (US & Canada)

Timezone Offset: 0 (-1439 to +1439) Minutes

Daylight Saving

Automatically adjust clock for daylight saving: Disabled

Start Daylight Saving: Month: March Day of Week: Sunday Week#: 1

End Daylight Saving: Month: November Day of Week: Sunday Week#: 1

To display this page:

Step	Description
1	Select the Services node in the navigation tree located on the left side of the Device Editor . The Services page opens.
2	In the Services page, set the Network Time Service field to Enabled . The Network Time Service node appears in the navigation tree.
3	Select the Network Time Service node in the navigation tree.

Viewing and Configuring Network Time Service Settings

The following settings can be viewed and edited in this page:

Property	Description	
NTP Server Configuration:		
Primary NTP Server IP Address	The IP address of the NTP server, from which the Ethernet communication module first requests a time setting.	
Secondary NTP Server IP Address	The IP address of the back-up NTP server, from which the Ethernet communication module requests a time setting, after not receiving a response from the primary NTP server.	
Polling Period	The frequency (1...120 seconds) the Ethernet communication module uses for requesting a time setting from the NTP server. Default = 18 seconds.	
Time Zone:		
Time Zone Setting	The time zone associated with the Ethernet communication module, selected from a list that includes time zones around the globe. Default = Greenwich Mean Time (GMT) + 0 minutes.	
Timezone Offset	The number of minutes (-1439...+1439) used to adjust the Time Zone Setting. Default = 0 minutes.	
Daylight Saving:		
Automatically adjust clock for daylight saving	<ul style="list-style-type: none"> Enabled: turns ON the automatic clock adjustment for daylight savings. Disabled: turns OFF the automatic clock adjustment for daylight savings. Default = Disabled. If automatic adjustment of the clock for daylight savings is enabled, use the next two fields to configure daylight saving adjustments.	
Start Daylight Saving	Month	Select the month daylight savings begins. Default = March.
	Day of Week	Select the day of the week daylight savings begins. Default = Sunday.
	Week#	Select the week of the month daylight savings begins. Default = 1 (first week of the month).

Property	Description	
End Daylight Saving	Month	Select the month daylight savings ends. Default = November.
	Day of Week	Select the day of the week daylight savings ends. Default = Sunday.
	Week#	Select the week of the month daylight savings ends. Default = 1 (first week of the month).

Section 2.6

Security

Security Features

Security and HTTP, FTP, and TFTP Services

You can enhance security for your project by disabling the FTP/TFTP and HTTP services at times when you do not need to use them. The module uses the HTTP service to provide access to the embedded webpages. The module uses the FTP and TFTP services to support various features including firmware upgrades, and FDR services.

The module's HTTP, FTP, and TFTP services can be disabled or enabled using the **DTM Browser Security** screen.

HTTP, FTP, and TFTP services are disabled by default in DTM instances created using BMX NOC 0401 module firmware version 2.04 or later and Unity Pro version 8.1 or later. They are enabled by default in instances created using previous versions of Unity Pro.

NOTE: Unity Pro is the former name of Control Expert for version 13.1 or earlier.

You can use Control Expert to enable or disable HTTP, FTP, and TFTP services as described in the following procedure.

If the HTTP, FTP, or TFTP services have been enabled with Control Expert, they can also be enabled or disabled at run time using a DATA_EXCH function block. (See the *Communication Block Library* for Control Expert.)

Using Control Expert to Enable and Disable Firmware Upgrade & FDR and Web Access Services

Perform the following steps to enable or disable FTP/TFTP or HTTP services on the module.

Step	Action
1	In the Control Expert main menu, select Tools → DTM Browser to open the DTM Browser .
2	Confirm that the DTM you want to use is not connected to the actual communication module or device. If necessary, disconnect the DTM from the module or device (<i>see page 46</i>).
3	In the DTM Browser , select the module. Right-click and select Open to open the Device Editor .
4	Click the Security node in the navigation tree in the left panel to open the Security screen.
5	On the Security screen, choose the appropriate setting: (Enabled or Disabled) for the service or services.
6	Click: <ul style="list-style-type: none">● Apply to save the changes and keep the window- or -● OK to save the changes and close the window

The edits do not take effect until they are successfully downloaded from your PC to the CPU and from the CPU to the communication modules and network devices.

Section 2.7

Configuring the Ethernet Communication Module as an EtherNet/IP Adapter

Overview

This section describes how to configure the Ethernet communication module to act as an EtherNet/IP adapter, using a functionality called Local Slave. The communication module supports up to three instances of local slaves.

In its role as a EtherNet/IP adapter, the module initiates no messages. Instead, it responds to:

- implicit messaging requests from a scanner device in the network, and
- explicit messaging requests—directed to the communication module's assembly object (*see page 247*)—from other devices on the network

NOTE: If no local slave instance is enabled, the communication module can respond to explicit messaging requests directed at its CIP objects (*see page 243*) other than the assembly object.

What Is in This Section?

This section contains the following topics:

Topic	Page
Introducing the Local Slave	111
Configuring a Local Slave	113
Local Slave Inputs and Outputs	118

Introducing the Local Slave

Local Slave Networking Example

The Ethernet communication module supports up to three instances of the local slave functionality. The local slave functionality allows other scanners on the network to read from, and write to, the Ethernet communication module using implicit messaging. Each local slave instance can accept one exclusive owner connection and one listen only connection. Through a local slave, a remote scanner can access the communication module's CIP Assembly object (*see page 247*). The local slave function is especially beneficial for peer to peer data exchanges at a repetitive rate.

NOTE:

- The Ethernet communication module can provide three local slave adapter instances, while simultaneously performing as a scanner. These roles are not mutually exclusive.
- The local slave is exclusively an EtherNet/IP functionality

In this example, the local slave instance is part of the following topology:

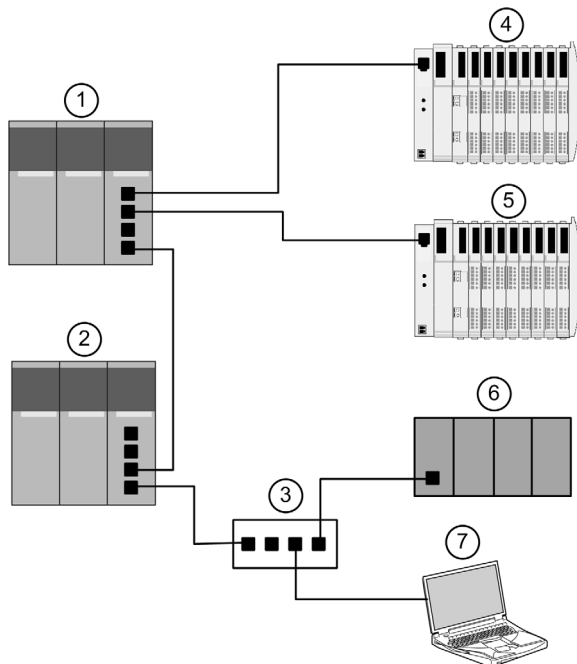

The sample configuration, above, includes the following devices:

- A primary PLC (1) incorporating the BMX NOC 0401 Ethernet communication module with one local slave instance enabled. The PLC scans I/O data from remote devices (4 and 5)
- A secondary PLC (2) that “listens” to the scan of the primary PLC’s local slave by the third-party PLC (6)
- A managed Ethernet switch (3)
- An Advantys STB island (4), with an STB NIC 2212 EtherNet/IP network interface module plus 8 I/O modules
- An Advantys STB island (5), with an STB NIP 2212 Modbus TCP network interface module plus 8 I/O modules
- A third party scanner (6)—which lacks adapter capability, and therefore cannot itself be scanned by the primary PLC (1)—that:
 - collects data from other sources (not part of this network)
 - writes data to inputs of the primary PLC’s local slave
 - scans the primary PLC’s local slave’s output data via an exclusive owner connection
- A PC running the following software:
 - Control Expert
 - the Control Expert Configuration Tool
 - Advantys Configuration Software

NOTE:

- Because the third party scanner (6) and the secondary scanner (2) are both receiving the same data produced by the local slave, configure the requested packet interval (RPI) setting of the third party scanner’s exclusive owner connection and the secondary scanner’s listen only connection to the same setting.
- By enabling a local slave on the primary PLC (1):
 - PLC (1) allows the third party PLC (6) to write to it at a repetitive rate, even if PLC (6) is not capable of acting as an adapter.
 - the secondary PLC (2) is able to scan the primary PLC (1) at a repetitive rate, rather than through application intensive explicit messaging.

The topics in this section show you how to use Control Expert software installed in the PC (7, above) to configure a local slave, and to create input and output items in support of the peer-to-peer data transfers between and among scanners.

Configuring a Local Slave

Description

The Ethernet communication module presents three identical **Local Slave** configuration pages. Use each page to configure a separate local slave instance. Create a local slave instance by:

- enabling and naming the local slave
- specifying the size of local slave input and output assemblies
- configuring local slave variable names

To display this page, select one of the three **Local Slave** nodes in the navigation tree located on the left side of the **Device Editor**.

NOTE: Refer to the topic *Configuring Properties in the Device Editor* ([see page 57](#)) for instructions on how to edit properties.

The following steps describe a sample configuration for **Local Slave 1**. Your configuration may be different.

Configuration Example: Local Slave 1

In the sample network configuration (*see Quantum using EcoStruxure™ Control Expert, 140 NOC 771 01 Ethernet Communication Module, User Manual*), the application in the third-party PLC produces data, which is available in the PLC Ethernet communication module as inputs. In this example, the third-party device produces the following information:

- production totals for manufacturing line A
- production totals for manufacturing line B
- the number of production interruption events for line A
- the number of production interruption events for line B

Any information that needs to be passed to the third-party device—for example, confirmation that data from the third-party device has been received by the PLC—is accessible in the third-party device as input data. In this example, the third-party device is programmed to scan Local Slave 1 for this confirmation.

When configuring inputs and outputs in both the local slave and the third-party PLC, associate inputs and outputs as follows:

Associate these local slave items:	With these third-party PLC items:
Outputs (T to O)—assembly instance 101	Inputs—assembly instance 101
Inputs (O to T)—assembly instance 102	Outputs—assembly instance 102

The configured **Local Slave** page looks like this:

The screenshot shows a configuration dialog box for a Local Slave. It is divided into three main sections: Properties, Assembly, and IO Structure Name.

- Properties:** Contains a 'Number' dropdown set to '000', an 'Active Configuration' dropdown set to 'Enabled', a 'Comment' text area, and a 'Connection Bit' input field set to '0'.
- Assembly:** Contains four input fields: 'Outputs (T to O):' (101), 'Outputs (T to O) Size:' (2) (1-509) Bytes, 'Inputs (O to T):' (102), 'Inputs (O to T) Size:' (8) (1-505) Bytes, 'Configuration:' (103), and 'Configuration Size:' (0) (0-200) Words.
- IO Structure Name:** Contains a 'Default Name' button and two sections: 'Input' and 'Output'. Each section has 'Structure Name' and 'Variable Name' input fields. For the Input section, the values are 'T_NOC01_LS1_IN' and 'NOC01_LS1_IN'. For the Output section, the values are 'T_NOC01_LS1_OUT' and 'NOC01_LS1_OUT'.

At the bottom of the dialog are three buttons: 'OK', 'Cancel', and 'Apply'.

Enabling and Naming the Local Slave

Use the **Properties** section of the **Local Slave** page to enable (or disable) and identify the local slave.

Setting	Description
Number	The unique number—or identifier—assigned to the device. By default, Control Expert assigns: <ul style="list-style-type: none"> ● 000 = local slave 1 ● 001 = local slave 2 ● 002 = local slave 3 In this example, accept the default 000 .
Active Configuration	<ul style="list-style-type: none"> ● Enabled activates the local slave. ● Disabled de-activates the local slave, but retains the current local slave settings. In this example, select Enabled .
Comment	An optional free text comment field up to 80 characters maximum. In this example, leave blank.
Connection bit	Auto-generated integer (0..127) indicating the offset of the connection's: <ul style="list-style-type: none"> ● health bit, located in the module's input area ● control bit, located in the module's output area Note: This setting is auto-generated after the local slave settings are input and the network configuration is saved.

Configuring the Size of Local Slave Input and Output Assemblies

Use the **Assemblies** section of the **Local Slave** page to configure the size of the local slave inputs and outputs. The assembly numbers are non-editable, and are assigned by Control Expert as follows:

Assembly number	Local slave number	Used for connection
101	1	T->O ¹
102	1	O->T Exclusive Owner
103	1	Configuration
199	1	O->T Listen Only
111	2	T->O
112	2	O->T Exclusive Owner
113	2	Configuration
200	2	O->T Listen Only
1. In this table: <ul style="list-style-type: none"> ● O indicates the originator—or scanner—device ● T indicates the target—or adapter—device 		

Assembly number	Local slave number	Used for connection
121	3	T->O
122	3	O->T Exclusive Owner
123	3	Configuration
201	3	O->T Listen Only

1. In this table:

- O indicates the originator—or scanner—device
- T indicates the target—or adapter—device

The **Local Slave** assembly settings include:

Setting	Description
Outputs (T->O)	A read-only value (see table, above). In this example, 101 .
Outputs (T->O) Size	The maximum size—in bytes—reserved for local slave outputs. An integer from 1 to 509. In this example, only two output bytes are used: type in 2 .
Inputs (O->T)	A read-only value (see table, above). In this example, 102 .
Inputs (O->T) Size	The maximum size—in bytes—reserved for local slave inputs. An integer from 0 to 505. In this example, only eight input bytes are used: type in 8 .
Configuration	A read-only value (see table, above). In this example, 103 .
Configuration Size	A read-only value set to 0 .

NOTE: When using explicit messaging to read the Ethernet communication module’s assembly object, you need to allocate sufficient room for the response, because the size of the response will equal the sum of:

the assembly size + Reply service (1 byte) + General Status (1 byte)

Configuring Local Slave I/O Variable Names

Each input and output that Control Expert creates for your application has both a non-editable structure name (used by Control Expert to internally identify input and output items) and an editable variable name.

Use the **I/O Structure Name** section of the **Local Slave** page to:

- view and edit local slave input and output variable names
- view non-editable local slave structure names

The following property settings have been made in this example:

Setting	Description
Input:	
Structure Name	<p>The read-only name for input structures. By default, it is the concatenation of:</p> <ul style="list-style-type: none"> • the prefix T_ • the alias device name—in this case NOC01 • the device number—in this case 01 • the suffix _IN <p>In this case, the default would be T_NOC01_01_IN.</p>
Variable Name	<p>The editable base name for input variables. By default, it is the concatenation of:</p> <ul style="list-style-type: none"> • the alias device name—in this case NOC01 • the device number—in this case 01 • the suffix _IN <p>In this case, the default would be NOC01_01_IN. For this example, accept the default variable name.</p>
Output:	
Structure Name	<p>The read-only name for output structures. By default, it is the concatenation of:</p> <ul style="list-style-type: none"> • the prefix T_ • the alias device name—in this case NOC01 • the device number—in this case 01 • the suffix _OUT <p>In this case, the default would be T_NOC01_01_OUT.</p>
Variable Name	<p>The editable base name for output variables. By default, it is the concatenation of:</p> <ul style="list-style-type: none"> • the alias device name—in this case NOC01 • the device number—in this case 01 • the suffix _OUT <p>In this case, the default would be NOC01_01_OUT. For this example, accept the default variable name.</p>

If you have edited one or more variable names, you can restore the default variable names by clicking on the **Default Name** button.

Local Slave Inputs and Outputs

Introduction

The Ethernet communication module serves as an adapter when the **Active Configuration** field is set to **Enabled** in the configuration window for one (or more) of the module's local slave nodes.

When a local slave instance of an Ethernet communication module is enabled, the designated memory location allocated to that instance is exposed to, and can be accessed by, other devices.

The I/O data exchange, between the remote device and the local slave, is configured as part of the remote device's configuration settings.

Configuring the I/O Items

You can configure input and output items in groups of 1 or more single bits, 8-bit bytes, 16-bit words, 32-bit dwords, or 32-bit IEEE floating values. The number of items you create depends upon the data type and size of each item.

The process for creating and defining I/O items for the local slave is the same as for any adapter class device, and depends upon the type of items you wish to create.

In support of the ongoing configuration example, the following items are required:

- 4 input word items
- 1 output word item

NOTE: The items created, below, are designed to hold data received from, or sent to, the third-party scanner. In addition to these items, it is necessary to include logic in the application programs in which the Ethernet communication module and the third-party scanner, respectively, are included. Writing this code is beyond the scope of this example.

Creating Input Word Items

To create input items for local slave 01:

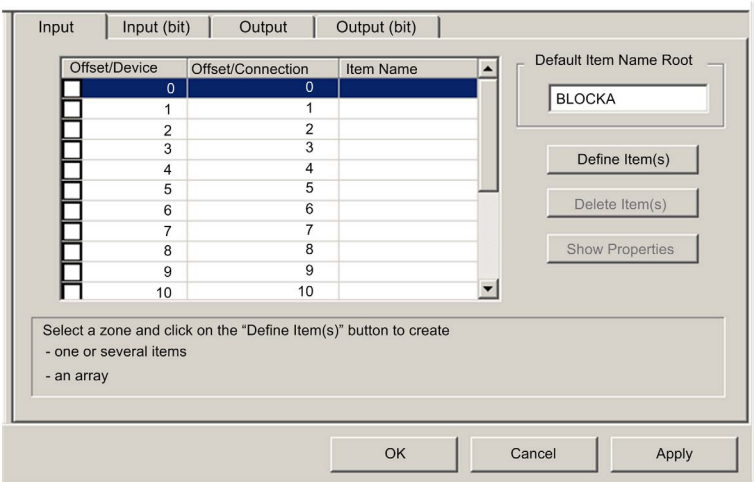
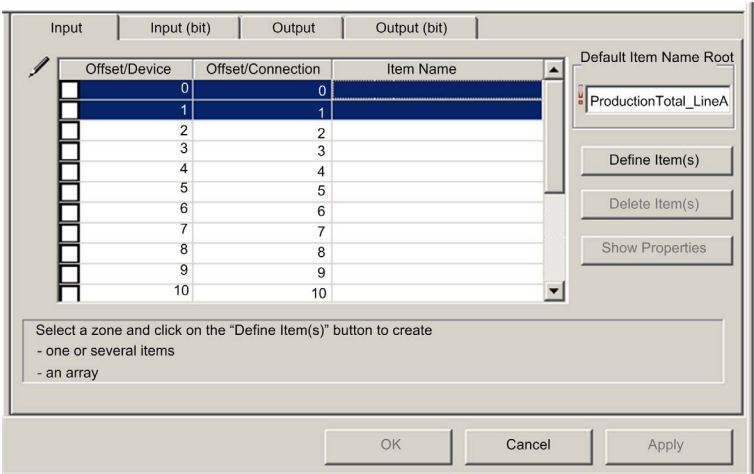
Step	Action
1	<p>Select the Input tab to open that page:</p>  <p>NOTE: In this example, each row represents a byte. Because the items you create will be a 16-bit words, each item consists of 2 rows.</p>
2	<p>In the Default Item Name Root input box type: ProductionTotal_LineA.</p>
3	<p>Starting at the beginning of the table, select the first two rows: 0 and 1:</p> 

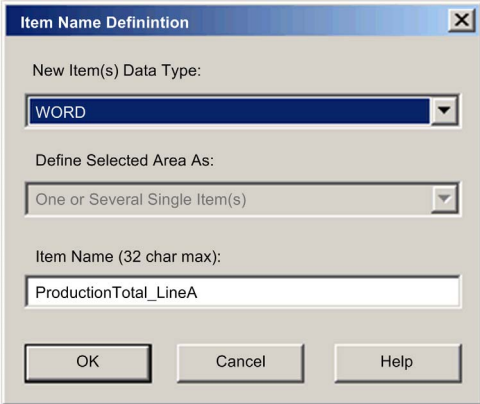
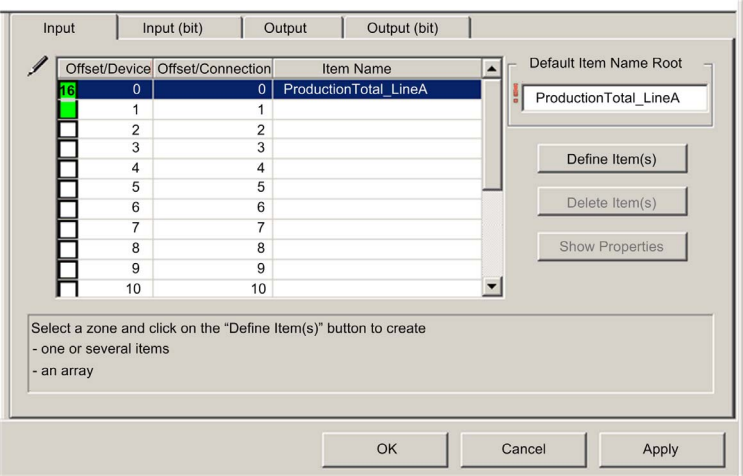
Step	Action
4	<p>Click the Define Item(s) button.</p> <p>Result: The Item Name Definition dialog opens:</p> 
5	<p>Select WORD as the New Item(s) Data Type, then click OK.</p> <p>Result: A new item is created:</p> 
6	<p>Click Apply to save the new items, and leave the page open.</p>
7	<p>Repeat steps 2 - 6 for each new word item you need to create. In this example, that includes the following items:</p> <ul style="list-style-type: none"> ● Rows 2-3, Default Items Name Root: ProductionTotal_LineB ● Rows 4-5: Default Items Name Root: Events_LineA ● Rows 6-7: Default Items Name Root: Events_LineB
8	<p>Create output words.</p>

Creating Output Word Items

To create output items for local slave 01:

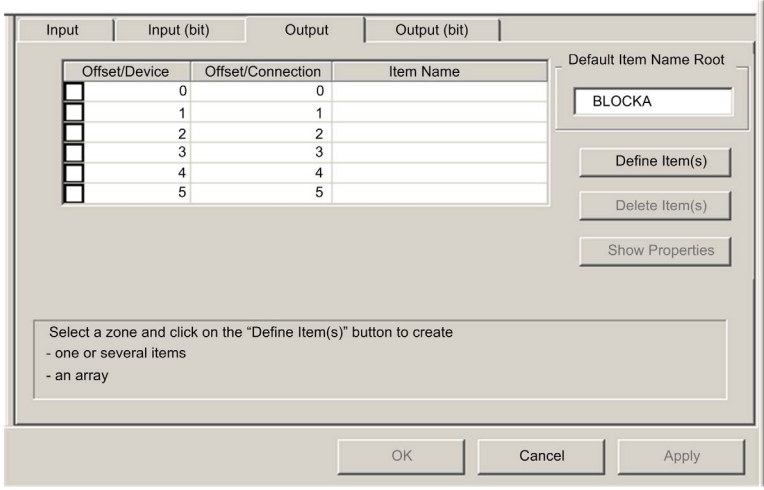
Step	Action
1	<p>Click the Output tab to open the following page:</p>  <p>NOTE: In this example, each row represents a byte. Because the only item you will create is a 16-bit word, you will select 2 rows.</p>
2	In the Default Item Name Root input box type: DataReceived .

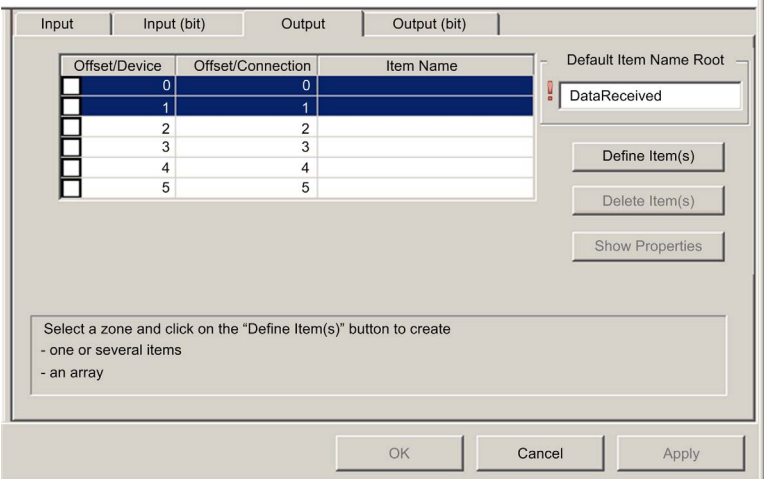
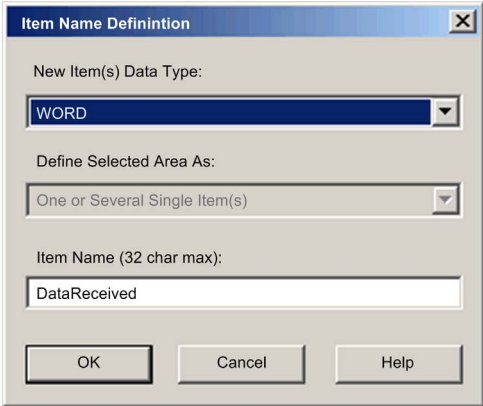
Step	Action
3	<p>Starting at the beginning of the table, select the first 2 rows, 0 and 1:</p> 
4	<p>Click the Define Item(s) button. Result: The Item Name Definition dialog opens:</p> 

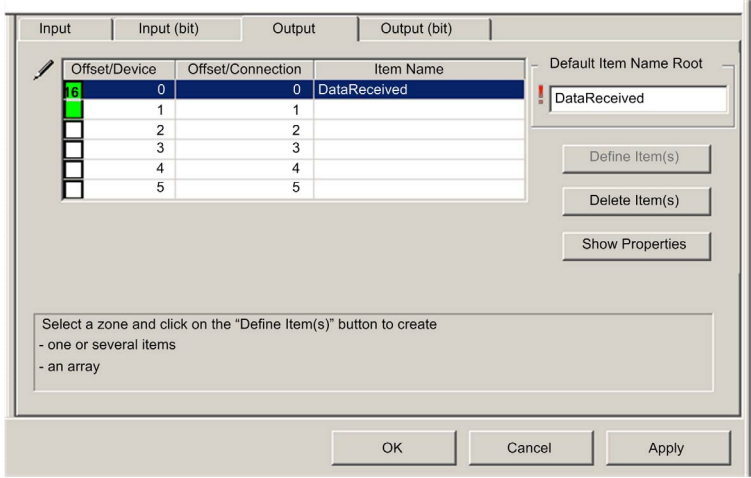
Step	Action
5	<p>Select WORD as the New Item(s) Data Type, then click OK. Result: A new item is created:</p> 
6	Click OK to close the Items window.
7	Select File → Save to save your edits.

Using Local Slave Inputs and Outputs

The inputs and outputs created, above, are used as follows:

- The third-party device updates values of the following variables:
 - ProductionTotal_LineA
 - ProductionTotal_LineB
 - Events_LineA
 - Events_LineB
- The Ethernet communication module updates value of the DataReceived variable in the third-party device at the configured RPI.

Chapter 3

Adding Devices to an Ethernet Network

Overview

This chapter presents examples of how to add devices to, and how to configure these device for operations on, your Ethernet network.

What Is in This Chapter?

This chapter contains the following sections:

Section	Topic	Page
3.1	Hardware Catalog	126
3.2	Adding an EtherNet/IP Device to the Network	135
3.3	Adding a Modbus TCP Device to the Network	170

Section 3.1

Hardware Catalog

Overview

Control Expert includes a collection of modules and devices—called the **Hardware Catalog**—that you can add to a Control Expert project. EtherNet/IP and Modbus TCP devices are located in the hardware catalog's **DTM Catalog** page. Each device in the catalog is represented by a DTM that defines the parameters of the module or device.

Not every device on the market today offer device-specific DTMs. Some devices are instead defined by a device-specific EDS file. Control Expert displays each EDS file in the form of a DTM. In this way, you can use Control Expert to configure these Ethernet/IP devices—defined by an EDS file—in the same way you would configure a DTM-defined device.

Other devices lack both a DTM and an EDS file. You can configure these devices by using a Generic DTM that is included in the **DTM Catalog** page.

This section address the topics:

- how to add a DTM to the catalog
- how to add an EDS file to the catalog
- how to update the catalog
- how to remove an EDS file from the catalog

What Is in This Section?

This section contains the following topics:

Topic	Page
Adding a DTM to the Control Expert Hardware Catalog	127
Add an EDS File to the Control Expert Hardware Catalog	128
Updating the Control Expert Hardware Catalog	131
Remove an EDS File from the Control Expert Hardware Catalog	133

Adding a DTM to the Control Expert Hardware Catalog

A Manufacturer Defined Process

Before you can add a DTM to the Control Expert **Hardware Catalog**, install it on the host PC—the same PC that is running Control Expert—by means of an installation process defined by the device manufacturer.

Consult your device documentation, provided by the device manufacturer, for information describing how to install a device DTM on your PC.

For instructions on how to install the BMX NOC 0401 Ethernet communication module, refer to the topic Installing Control Expert Ethernet Configuration Tool Software (*see page 26*).

NOTE: After you successfully install a device DTM on your PC, update the Control Expert Hardware Catalog (*see page 131*) so the new DTM is visible in the catalog and available to be added to a Control Expert project.

Add an EDS File to the Control Expert Hardware Catalog

Overview

Control Expert includes a wizard you can use to add one or more EDS files to the Control Expert **Hardware Catalog**. The wizard presents a series of instruction screens that:



- simplify the process of adding EDS files to the catalog, and
- provide a redundancy check in case you attempt to add duplicate EDS files to the catalog

NOTE: The Control Expert **Hardware Catalog** displays a partial collection of DTMs and EDS files registered with the ODVA. This library includes DTMs and EDS files for products not manufactured or sold by Schneider Electric. The non-Schneider Electric EDS files are identified by vendor in the catalog. Please contact the identified device's manufacturer for inquiries regarding the corresponding non-Schneider Electric EDS files.

Adding EDS Files

To add one or more EDS files to the library:

Step	Action
1	If the DTM Browser is not already open, in the Control Expert main menu select Tools → DTM Browser .
2	In the DTM Browser , select a communication module, then click the right mouse button. A pop-up menu opens.
3	In the pop-up menu, select Device menu → Add EDS to library . The introductory page of the wizard opens.
4	<p>Click Next. Page 2 of the wizard opens:</p> 
5	<p>In the Select the Location of the EDS File(s) section, select either:</p> <ul style="list-style-type: none"> ● Add File(s), to add one or more EDS files you will individually select, or ● Add all the EDS from the Directory, to add all files from a folder you will select. <ul style="list-style-type: none"> ○ Select Look in Subfolders to also add EDS files in subfolders beneath the folder you selected.

Step	Action
6	Click the Browse button. The Open dialog opens.
7	Use the Open dialog to navigate to and select: <ul style="list-style-type: none"> ● one or more EDS files, or ● a folder containing EDS files
8	After you have made your selections, click Open . The dialog closes and your selection appears in the Directory or File Name field.
9	Choose the naming convention rule for the EDS DTM name creation. The new naming convention is based on Model Name / Product Name and Revision. A random character is automatically suffixed when Model Name / Product Name and Revision of an EDS file of the library are identical. The new naming convention is irrespective of the order in which EDS files are added to device library. By default, the New Naming Convention check box is selected and the new naming rule applies. NOTE: To keep backward compatibility with Control Expert versions, unchecked the New Naming Convention check box and the naming rule is based on Model Name / Product Name.
10	Click Next . The wizard compares the selected EDS files against existing files in the library.
11	(Conditional) If one or more selected EDS files is a duplicate, a File Already Exists message opens. Close the message.
12	Page 3 of the wizard opens indicating the Status of each device you attempted to add: <ul style="list-style-type: none"> ● a green check mark  indicates the EDS file can be added ● a blue informational icon  indicates a redundant file ● a red exclamation point  indicates an invalid EDS file (Optional) Select a file in the list, then click View Selected File to open it.
13	Click Next to add the non-duplicate files. Page 4 of the wizard opens, indicating the action is complete.
14	Click Finish to close the wizard.
15	The next step is to update the Control Expert Hardware Catalog (<i>see page 131</i>), so that the newly added device is available for inclusion in a Control Expert project.

Updating the Control Expert Hardware Catalog

Updating Hardware Catalog

After you have followed the manufacturer's instructions and installed a module or device DTM on your PC, the next step is to update the Control Expert **Hardware Catalog**. Updating the **Hardware Catalog** makes the new Ethernet module or device available for addition to your Control Expert application.

To update the **Hardware Catalog**:

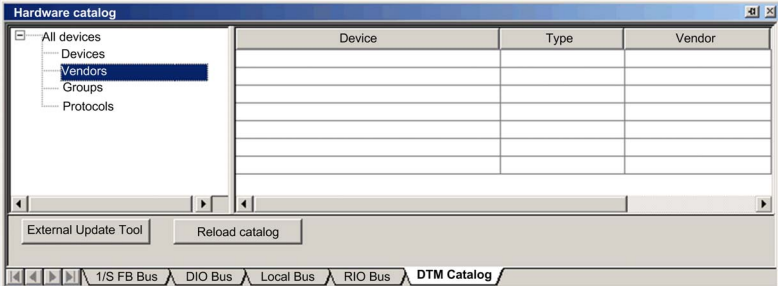
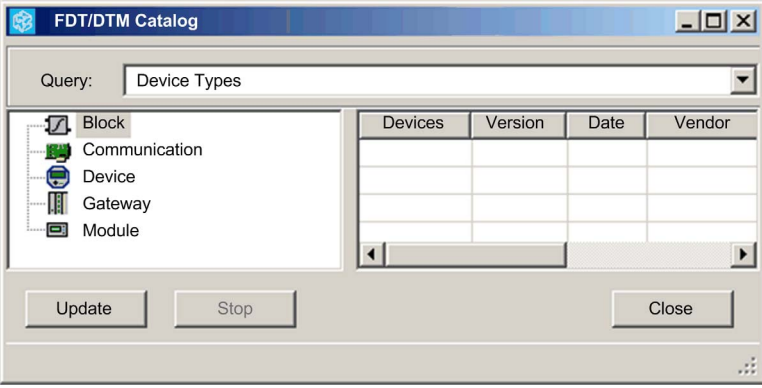
Step	Action
1	In the Control Expert main menu, select Tools → Hardware Catalog . The Hardware Catalog window opens.
2	In the Hardware Catalog window, select the DTM Catalog tab to display a module and device DTM list. At the time of initial software installation, the catalog displays no devices: 
3	Click the External Update Tool button. The FDT/DTM Catalog window opens: 
4	In the FDT/DTM Catalog window, click Update . The window refreshes itself, as indicated by the progress bar in the lower right corner of the window.

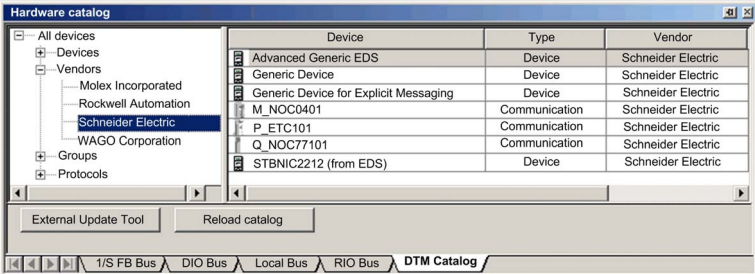
Step	Action																								
5	After the update has finished, click Close . The FDT/DTM Catalog window closes and the Hardware Catalog displays.																								
6	<p>In the Hardware Catalog window, click Reload catalog to refresh the DTM list.</p>  <p>The screenshot shows the 'Hardware catalog' window with a tree view on the left and a table of devices on the right. The tree view includes 'All devices', 'Devices', 'Vendors' (with sub-items: Moxel Incorporated, Rockwell Automation, Schneider Electric, WAGO Corporation), 'Groups', and 'Protocols'. The 'Schneider Electric' vendor is selected. The table lists the following devices:</p> <table border="1" data-bbox="514 324 1035 470"> <thead> <tr> <th>Device</th> <th>Type</th> <th>Vendor</th> </tr> </thead> <tbody> <tr> <td>Advanced Generic EDS</td> <td>Device</td> <td>Schneider Electric</td> </tr> <tr> <td>Generic Device</td> <td>Device</td> <td>Schneider Electric</td> </tr> <tr> <td>Generic Device for Explicit Messaging</td> <td>Device</td> <td>Schneider Electric</td> </tr> <tr> <td>M_NOC0401</td> <td>Communication</td> <td>Schneider Electric</td> </tr> <tr> <td>P_ETC101</td> <td>Communication</td> <td>Schneider Electric</td> </tr> <tr> <td>Q_NOC77101</td> <td>Communication</td> <td>Schneider Electric</td> </tr> <tr> <td>STBNIC2212 (from EDS)</td> <td>Device</td> <td>Schneider Electric</td> </tr> </tbody> </table> <p>At the bottom of the window, there are buttons for 'External Update Tool' and 'Reload catalog'. The bottom status bar shows navigation options: '1/S FB Bus', 'DIO Bus', 'Local Bus', 'RIO Bus', and 'DTM Catalog'.</p>	Device	Type	Vendor	Advanced Generic EDS	Device	Schneider Electric	Generic Device	Device	Schneider Electric	Generic Device for Explicit Messaging	Device	Schneider Electric	M_NOC0401	Communication	Schneider Electric	P_ETC101	Communication	Schneider Electric	Q_NOC77101	Communication	Schneider Electric	STBNIC2212 (from EDS)	Device	Schneider Electric
Device	Type	Vendor																							
Advanced Generic EDS	Device	Schneider Electric																							
Generic Device	Device	Schneider Electric																							
Generic Device for Explicit Messaging	Device	Schneider Electric																							
M_NOC0401	Communication	Schneider Electric																							
P_ETC101	Communication	Schneider Electric																							
Q_NOC77101	Communication	Schneider Electric																							
STBNIC2212 (from EDS)	Device	Schneider Electric																							

Remove an EDS File from the Control Expert Hardware Catalog

Overview

You can remove a module or device from the list of available devices in the Control Expert **Hardware Catalog** by removing its EDS file. When you remove an EDS file from the library, the device or module is no longer displayed by Control Expert in the **DTM Catalog** page of the **Hardware Catalog** window.

However, removing an EDS file from the library does not delete the file. Instead, the EDS file remains in its stored location and can again be added to the catalog (*see page 128*) at a future time.

Removing an EDS File from the Catalog

To remove an EDS file from the catalog:

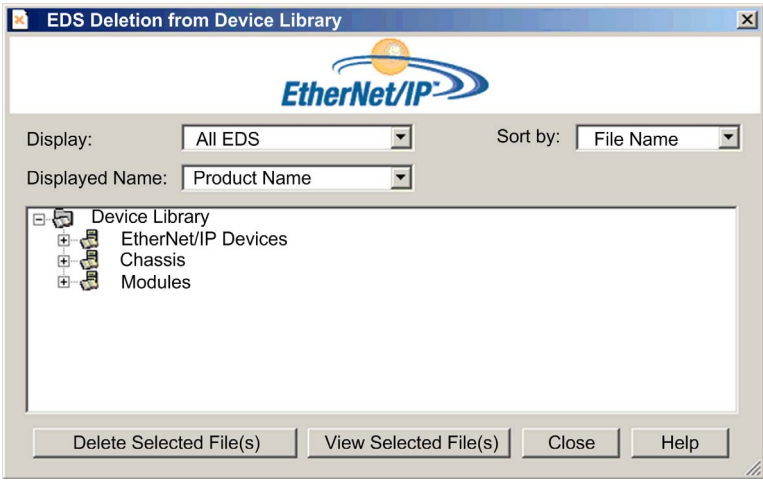
Step	Action
1	If the DTM Browser is not already open, in the Control Expert main menu select Tools → DTM Browser .
2	In the DTM Browser , select a communication module, then click the right mouse button. A pop-up menu opens.
3	In the pop-up menu, select Device menu → Remove EDS from library . The following window opens: 

Step	Action						
4	<p>Use the selection lists in the heading of this window to specify how EDS files will be displayed:</p> <table border="1" data-bbox="290 233 1218 630"> <tr> <td data-bbox="290 233 543 383">Display</td> <td data-bbox="543 233 1218 383"> Filters the list of displayed EDS files; select: <ul style="list-style-type: none"> ● All EDS (no filtering) ● Only Devices ● Only Chassis ● Only Modules </td> </tr> <tr> <td data-bbox="290 383 543 532">Sort by</td> <td data-bbox="543 383 1218 532"> Sorts the list of displayed EDS files; select: <ul style="list-style-type: none"> ● File Name ● Manufacturer ● Category ● Device Name </td> </tr> <tr> <td data-bbox="290 532 543 630">Displayed Name</td> <td data-bbox="543 532 1218 630"> The description displayed for each device; select: <ul style="list-style-type: none"> ● Catalog Name ● Product Name </td> </tr> </table>	Display	Filters the list of displayed EDS files; select: <ul style="list-style-type: none"> ● All EDS (no filtering) ● Only Devices ● Only Chassis ● Only Modules 	Sort by	Sorts the list of displayed EDS files; select: <ul style="list-style-type: none"> ● File Name ● Manufacturer ● Category ● Device Name 	Displayed Name	The description displayed for each device; select: <ul style="list-style-type: none"> ● Catalog Name ● Product Name
Display	Filters the list of displayed EDS files; select: <ul style="list-style-type: none"> ● All EDS (no filtering) ● Only Devices ● Only Chassis ● Only Modules 						
Sort by	Sorts the list of displayed EDS files; select: <ul style="list-style-type: none"> ● File Name ● Manufacturer ● Category ● Device Name 						
Displayed Name	The description displayed for each device; select: <ul style="list-style-type: none"> ● Catalog Name ● Product Name 						
5	<p>In the Device Library tree control, navigate to and select the EDS file you want to remove.</p>						
6	<p>(Optional) Click the View Selected File button to display the read-only contents of the selected EDS file.</p>						
7	<p>Click the Delete Selected File button. A message box opens.</p>						
8	<p>Click Yes to remove the selected EDS file from the list.</p>						
9	<p>When you have finished removing EDS files, click Close.</p>						
10	<p>The next step is to update the Hardware Catalog (see page 131).</p>						

Section 3.2

Adding an EtherNet/IP Device to the Network

Overview

This section extends the sample Control Expert application, by describing how to:

- add an STB NIC 2212 EtherNet/IP network interface module to your Control Expert application
- configure the STB NIC 2212 module
- configure EtherNet/IP connections linking the BMX NOC 0401 communication module and the STB NIC 2212 network interface module
- configure I/O items for the Advantys Island

NOTE: The instructions in this chapter describe a single, specific device configuration example. Refer to the Control Expert help files for additional information about alternative configuration choices.

What Is in This Section?

This section contains the following topics:

Topic	Page
Setting Up Your Network	136
Adding an STB NIC 2212 Remote Device	138
Configuring STB NIC 2212 Properties	140
Configuring EtherNet/IP Connections	146
Connecting to the Advantys STB Island	152
Configuring I/O Items	156

Setting Up Your Network

Overview

This sample network includes the following hardware and software:

- a controller rack with:
 - BMX CPS 2000, 100/240 VAC power supply
 - BMX P34 20302 controller
 - BMX NOC 0401.2 Ethernet communication module
- a remote STB Advantys island with:
 - STB NIC 2212 EtherNet/IP network interface module
 - STB PDT 3100 power distribution module
 - STB DDI 3230 2 pt digital input module
 - STB DDO 3200 2 pt digital output module
 - STB DDI 3420 4 pt digital input module
 - STB DDO 3410 4 pt digital output module
 - STB DDI 3610 6 pt digital input module
 - STB DDO 3600 6 pt digital output module
 - STB AVI 1270 2 pt analog input module
 - STB AVO 1250 2 pt analog output module
- a PC running both Unity Pro (version 5.0 or higher) and Advantys configuration software (version 5.0 or higher)
NOTE: Unity Pro is the former name of Control Expert for version 13.1 or earlier.
- an Ethernet managed switch that is connected to the both the controller and island by means of twisted pair Ethernet cable and RJ45 connectors.

Network Topology

The Ethernet network devices used in this configuration include the following:

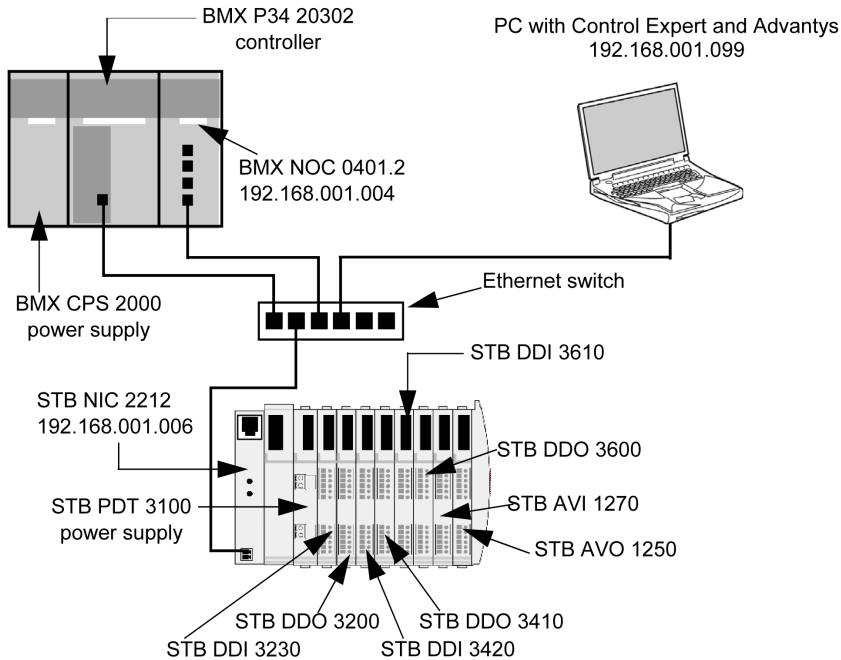

To re-create this example:

- use the IP addresses for your own configuration's:
 - PC
 - BMX NOC 0401.2 Ethernet communication module
 - STB NIC 2212 network interface module
- check wiring

NOTE: Control Expert software running in the PC is used to configure the BMX P34 20302 controller. In this example, the PC is indirectly wired to the CPU's Ethernet port via the Ethernet switch. Alternatively, you could bypass the switch and directly wire the PC to either the CPU's Modbus or USB ports.

Adding an STB NIC 2212 Remote Device

Overview

You can use the Control Expert device library to add a remote device—in this example the STB NIC 2212 module—to your project. Only a remote device that is part of your Control Expert device library can be added to your project. Refer to the topic describing the Add EDS File Wizard (*see page 128*) for instructions on how to add a device EDS file to the device library.

Alternatively, with a remote device already added to your device library, you can use automatic device discovery to populate your project. Perform automatic device discovery by using the **Field bus discovery** command with a communication module selected in the **DTM Browser**.

In either case, you need to update the list of available modules and devices, as follows:

Step	Action
1	In the Control Expert main menu, select Tools → Hardware Catalog to display that window.
2	In the Hardware Catalog window, click on the DTM Catalog tab to open that page.
2	In the DTM Catalog page, click Reload catalog . The list of available devices, as displayed both in the DTM Catalog page and the Add dialog, is updated and reflects any device additions or deletions.

Adding an STB NIC 2212 Remote Device

To add the STB NIC 2212 to your project, follow these steps:

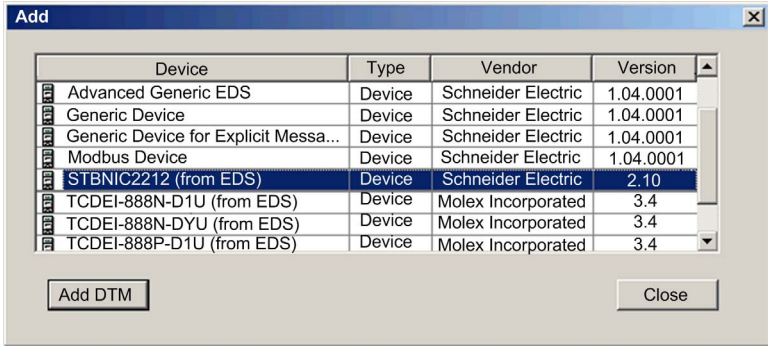
Step	Action
1	In the DTM Browser , select the Ethernet communication module node, and then click the right mouse button. A pop-up menu opens.
2	In the pop-up menu, select Add... The following dialog opens: 
3	In the Add dialog, select the STBNIC2212 , then click Add DTM . The Properties window for the STB NIC 2212 network interface module opens.

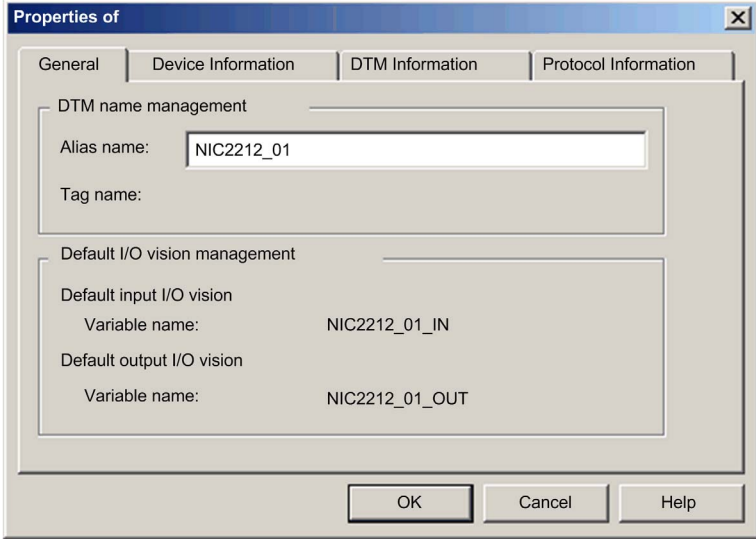
Step	Action
4	<p>In the General page of the Properties window, edit the default Alias name, because retaining the original default name can result in duplicate module names. In this example, type in the name NIC2212_01:</p>  <p>When you edit the Alias name, Control Expert applies it as the base for both structure and variable names.</p> <p>NOTE: No additional editing needs to be performed in the pages of this window. Except for the Alias name field, parameters are read-only.</p>
5	<p>Click OK. Control Expert adds the new STB NIC 2212 network interface module to the DTM Browser, beneath the communication module.</p>
6	<p>Refer to the topic <i>Configuring Properties in the Device Editor</i> (see page 57) for instructions on how to save your configuration edits.</p>

The next step is to configure the device you have just added to the project.

Configuring STB NIC 2212 Properties

Overview

Use the pages of the **Device Editor** to view and edit settings for a remote device. Before you can edit the device settings, disconnect the DTM from the remote device (*see page 49*).

To display the DTM settings for a remote device, select the device name, which is found under the **Device List** node in the left pane of the **Device Editor**.

For the purposes of this example, which configures an STB NIC 2212 network interface module, select the node named **NIC2212 01**. The **Device Editor** displays the following pages:

- Properties
- Address Setting

NOTE: Refer to the topic *Configuring Properties in the Device Editor* (*see page 57*) for instructions on how to edit properties.

Configuring the Properties Page

The **Properties** page for an STB NIC 2212 network interface module looks like this:

The screenshot shows a configuration window with the following elements:

- Properties** tab selected.
- Properties** section:
 - Number: 003 (dropdown)
 - Active Configuration: Enabled (dropdown)
 - Comment: (text area)
- IO Structure Name** section:
 - Default Name button
 - Input** sub-section:
 - Structure Name: T_NIC2212_01_IN
 - Variable Name: NIC2212_01_IN
 - Output** sub-section:
 - Structure Name: T_NIC2212_01_OUT
 - Variable Name: NIC2212_01_OUT
- Items Management** section:
 - Import Mode: Manual (dropdown)
 - Reimport Items button
- Buttons: OK, Cancel, Apply

The following settings are used in this sample configuration. Use settings that are appropriate for your actual application:

Step	Action	
1	In the Properties section of the page, edit the following:	
	Number	The relative position of the device in the list, from 0 to 127. For this example, accept the default of 003 .
	Active Configuration	<ul style="list-style-type: none"> ● Enabled: adds this device to the Control Expert project configuration ● Disabled: removes this device from the Control Expert project configuration Accept the default setting of Enabled .
2	In the IO Structure Name section of the page, edit the following:	
	Input area:	
	Structure Name	(Read-only) Control Expert automatically assigns a structure name based on the variable name, in this case T_NIC2212_01_IN .
	Variable Name	Accept the auto-generated input variable name (based on the alias name <i>(see page 138)</i>): NIC2212_01_IN .
	Output area:	
	Structure Name	(Read-only) Control Expert automatically assigns a structure name based on the variable name, in this case T_NIC2212_01_OUT .
	Variable Name	Accept the auto-generated output variable name (based on the alias name): NIC2212_01_OUT .
Default Name button	Restores the default variable and structure names. For this example, custom names are used instead of the default names.	

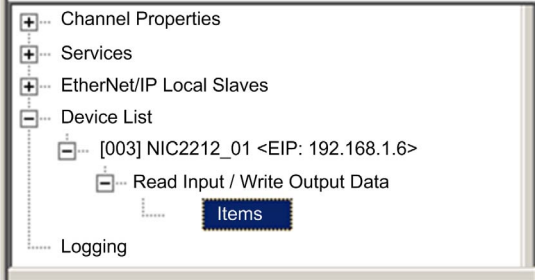
Step	Action	
3	In the Items Management section of the page, edit the following:	
	Import mode	<ul style="list-style-type: none"> ● Automatic: Select this if I/O items are pre-defined for the device in its DTM, and will not subsequently be edited. These items are automatically created and added to the configuration, and later updated if the items list if the device DTM changes. These auto-created items cannot be edited in the Device Editor. ● Manual: Select this if I/O items will be manually created or edited. If the device DTM pre-defines I/O items, those pre-defined I/O items are automatically created and added to the configuration, and can later be manually edited in the Device Editor. The I/O items list is not affected by changes to the device DTM. <p>NOTE:</p> <ul style="list-style-type: none"> ● Because the STB NIC 2212 DTM does not contain pre-configured input and output items, select Manual. ● To view I/O items, navigate to and select the Items node in the left pane of the Device Editor, as follows:  <p>The screenshot shows a tree view in the Device Editor. The root node is 'Channel Properties', which is expanded to show 'Services', 'EtherNet/IP Local Slaves', 'Device List', and 'Logging'. 'Device List' is expanded to show '[003] NIC2212_01 <EIP: 192.168.1.6>', which is further expanded to show 'Read Input / Write Output Data'. The 'Items' node under 'Read Input / Write Output Data' is highlighted with a blue dashed border.</p>
	Reimport Items	Imports the I/O items list from the device DTM, overwriting any manual I/O item edits. Enabled only when Import mode is set to Manual .
4	Click Apply to save your edits, and leave the window open for further edits.	

Configuring the Address Setting Page

Use the **Address Setting** page to enable the DHCP client in the STB NIC 2212 network interface module. When the DHCP client is enabled in the remote device, it will obtain its IP address from the DHCP server in the Ethernet communication module. The **Address Setting** page looks like this:

The screenshot shows a dialog box titled "Address Setting" with two tabs: "Properties" and "Address Setting". The "Address Setting" tab is active. The dialog contains the following fields and controls:

- Change Address:** A section containing an "IP Address:" field with the value "192 . 168 . 1 . 6".
- Address Server:** A section containing:
 - "DHCP for this device": A dropdown menu set to "Enabled".
 - "Identified by:": A dropdown menu set to "Device Name".
 - "Identifier:": A text field containing "NIC2212_01".
 - "Subnet Mask:": A text field containing "255 . 255 . 255 . 0".
 - "Gateway:": A text field containing "0 . 0 . 0 . 0".

At the bottom of the dialog are three buttons: "OK", "Cancel", and "Apply".

The following settings are used in this sample configuration. Use settings that are appropriate for your actual application:

Step	Action												
1	<p>In the Address Settings page, edit the following:</p> <table border="1" data-bbox="319 305 1258 1076"> <tr> <td data-bbox="319 305 548 492">IP Address</td> <td data-bbox="548 305 1258 492"> <p>By default:</p> <ul style="list-style-type: none"> the first three octet values equal the first three octet values of the Ethernet communication module, and the fourth octet value equals this device Number setting—in this case, the default value would be 004. <p>In our continuing example, type in the address 192.168.1.6.</p> </td> </tr> <tr> <td data-bbox="319 492 548 678">DHCP for this Device</td> <td data-bbox="548 492 1258 678"> <ul style="list-style-type: none"> Enabled activates the DHCP client in this device. The device obtains its IP address from the DHCP service provided by the Ethernet communication module and appears on the auto-generated DHCP client list (<i>see page 82</i>). Disabled (the default) de-activates the DHCP client in this device. <p>Select Enabled.</p> </td> </tr> <tr> <td data-bbox="319 678 548 808">Identified by</td> <td data-bbox="548 678 1258 808"> <p>If DHCP for this Device is Enabled, this indicates the device identifier type:</p> <ul style="list-style-type: none"> MAC Address, or Device Name <p>Select Device Name.</p> </td> </tr> <tr> <td data-bbox="319 808 548 898">Identifier</td> <td data-bbox="548 808 1258 898"> <p>If DHCP for this Device is Enabled, the specific device MAC Address or Name value.</p> <p>Accept the default setting of NIC2212_01 (based on the Alias name).</p> </td> </tr> <tr> <td data-bbox="319 898 548 963">Mask</td> <td data-bbox="548 898 1258 963"> <p>The device subnet mask. The default = 255.255.255.0.</p> <p>Accept the default value.</p> </td> </tr> <tr> <td data-bbox="319 963 548 1076">Gateway</td> <td data-bbox="548 963 1258 1076"> <p>The gateway address used to reach this device. The default of 0.0.0.0 indicates this device is located on the same subnet as the Ethernet communication module.</p> <p>Accept the default value.</p> </td> </tr> </table>	IP Address	<p>By default:</p> <ul style="list-style-type: none"> the first three octet values equal the first three octet values of the Ethernet communication module, and the fourth octet value equals this device Number setting—in this case, the default value would be 004. <p>In our continuing example, type in the address 192.168.1.6.</p>	DHCP for this Device	<ul style="list-style-type: none"> Enabled activates the DHCP client in this device. The device obtains its IP address from the DHCP service provided by the Ethernet communication module and appears on the auto-generated DHCP client list (<i>see page 82</i>). Disabled (the default) de-activates the DHCP client in this device. <p>Select Enabled.</p>	Identified by	<p>If DHCP for this Device is Enabled, this indicates the device identifier type:</p> <ul style="list-style-type: none"> MAC Address, or Device Name <p>Select Device Name.</p>	Identifier	<p>If DHCP for this Device is Enabled, the specific device MAC Address or Name value.</p> <p>Accept the default setting of NIC2212_01 (based on the Alias name).</p>	Mask	<p>The device subnet mask. The default = 255.255.255.0.</p> <p>Accept the default value.</p>	Gateway	<p>The gateway address used to reach this device. The default of 0.0.0.0 indicates this device is located on the same subnet as the Ethernet communication module.</p> <p>Accept the default value.</p>
IP Address	<p>By default:</p> <ul style="list-style-type: none"> the first three octet values equal the first three octet values of the Ethernet communication module, and the fourth octet value equals this device Number setting—in this case, the default value would be 004. <p>In our continuing example, type in the address 192.168.1.6.</p>												
DHCP for this Device	<ul style="list-style-type: none"> Enabled activates the DHCP client in this device. The device obtains its IP address from the DHCP service provided by the Ethernet communication module and appears on the auto-generated DHCP client list (<i>see page 82</i>). Disabled (the default) de-activates the DHCP client in this device. <p>Select Enabled.</p>												
Identified by	<p>If DHCP for this Device is Enabled, this indicates the device identifier type:</p> <ul style="list-style-type: none"> MAC Address, or Device Name <p>Select Device Name.</p>												
Identifier	<p>If DHCP for this Device is Enabled, the specific device MAC Address or Name value.</p> <p>Accept the default setting of NIC2212_01 (based on the Alias name).</p>												
Mask	<p>The device subnet mask. The default = 255.255.255.0.</p> <p>Accept the default value.</p>												
Gateway	<p>The gateway address used to reach this device. The default of 0.0.0.0 indicates this device is located on the same subnet as the Ethernet communication module.</p> <p>Accept the default value.</p>												
2	Click OK to save your edits.												

The next step is to configure the connection between the communication module and the remote device.

Configuring EtherNet/IP Connections

Overview

An EtherNet/IP connection provides a communication link between two or more devices. Properties for a single connection can be configured in the DTMs for the connected devices.

Use the **Device Editor** to view and edit connection settings. The following example presents settings for a connection between the BMX NOC 0401 communication module and a remote STB NIC 2212 network interface module. Configuration edits are made to the DTMs for each device.

When making DTM edits, disconnect the selected DTM from the actual module or device (*see page 49*).

NOTE: Refer to the topic *Configuring Properties in the Device Editor* (*see page 57*) for instructions on how to edit properties.

Configuring Connection Settings in the Communication Module DTM

Control Expert automatically creates a connection between a communication module and remote device, when the remote device is added to the Control Expert project. Thereafter, many edits to the connection can be made in the DTM for the remote device. However, some of the connection parameters can also be configured in the DTM for the communication module, as demonstrated below.

The following connection settings for this sample configuration can be set in the DTM for the communication module. Use settings that are appropriate for your actual application:

Step	Action
1	<p>Open the DTM for the communications module—in this example NOC01—by selecting it in the Device Editor, then do one of the following:</p> <ul style="list-style-type: none"> ● in the main menu, select Edit → Open, or ● click the right mouse button, and select Open in the pop-up menu <p>The communication module DTM opens in the Device Editor.</p>
2	<p>In the navigation pane (on the left side of the Device Editor) select the node representing the connection from the communication module to the remote device, in this case: Device List → NIC2212_01 → Read Input / Write Output Data</p>

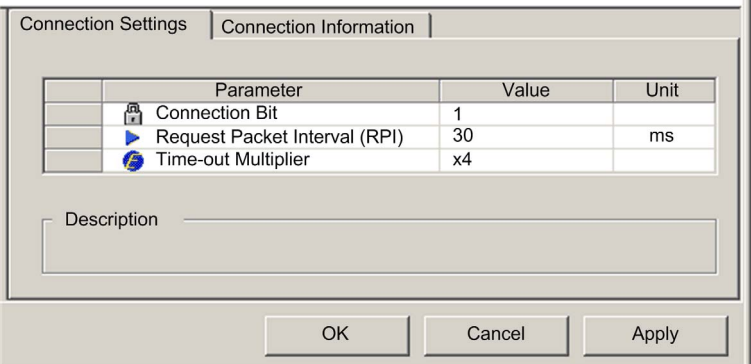
Step	Action						
3	<p>Click on the Connection Settings tab to open the following page:</p>  <p>NOTE: To view the Time-out Multiplier parameter, confirm that Control Expert is operating in Advanced Mode.</p>						
4	<p>In the Connection Settings page, edit the following settings:</p> <table border="1" data-bbox="310 743 1251 1307"> <tbody> <tr> <td data-bbox="310 743 536 1057">Connection Bit</td> <td data-bbox="536 743 1251 1057"> <p>(Read-only) The offset for both the health bit and the control bit for this connection. Offset values are auto-generated by the Control Expert Ethernet Configuration Tool, beginning at 0, and are prioritized according to the connection type, as follows:</p> <ol style="list-style-type: none"> 1 Modbus TCP connections 2 local slave connections 3 EtherNet/IP connections <p>NOTE: The initial value of this EtherNet/IP connection is 1, because only a single local slave has previously been enabled. When a single Modbus TCP connection is created, the value of this connection bit offset changes to 2.</p> </td> </tr> <tr> <td data-bbox="310 1057 536 1187">Request Packet Interval (RPI)</td> <td data-bbox="536 1057 1251 1187"> <p>The refresh period for this connection, from 2 to 65535 ms. Default = 12 ms. Type in 30 ms.</p> <p>NOTE: This parameter can be set in the DTM for the communication module or the remote device.</p> </td> </tr> <tr> <td data-bbox="310 1187 536 1307">Time-out Multiplier</td> <td data-bbox="536 1187 1251 1307"> <p>This setting, multiplied against the RPI, produces a value that triggers an inactivity timeout. Setting selections include: x4, x8, x16, x32, x64, x128, x256 and x512.</p> <p>Accept the default of x4.</p> </td> </tr> </tbody> </table> <p>NOTE: The Connection Information page is read-only when the communication module is selected. This information needs to be set in the DTM for the remote device.</p>	Connection Bit	<p>(Read-only) The offset for both the health bit and the control bit for this connection. Offset values are auto-generated by the Control Expert Ethernet Configuration Tool, beginning at 0, and are prioritized according to the connection type, as follows:</p> <ol style="list-style-type: none"> 1 Modbus TCP connections 2 local slave connections 3 EtherNet/IP connections <p>NOTE: The initial value of this EtherNet/IP connection is 1, because only a single local slave has previously been enabled. When a single Modbus TCP connection is created, the value of this connection bit offset changes to 2.</p>	Request Packet Interval (RPI)	<p>The refresh period for this connection, from 2 to 65535 ms. Default = 12 ms. Type in 30 ms.</p> <p>NOTE: This parameter can be set in the DTM for the communication module or the remote device.</p>	Time-out Multiplier	<p>This setting, multiplied against the RPI, produces a value that triggers an inactivity timeout. Setting selections include: x4, x8, x16, x32, x64, x128, x256 and x512.</p> <p>Accept the default of x4.</p>
Connection Bit	<p>(Read-only) The offset for both the health bit and the control bit for this connection. Offset values are auto-generated by the Control Expert Ethernet Configuration Tool, beginning at 0, and are prioritized according to the connection type, as follows:</p> <ol style="list-style-type: none"> 1 Modbus TCP connections 2 local slave connections 3 EtherNet/IP connections <p>NOTE: The initial value of this EtherNet/IP connection is 1, because only a single local slave has previously been enabled. When a single Modbus TCP connection is created, the value of this connection bit offset changes to 2.</p>						
Request Packet Interval (RPI)	<p>The refresh period for this connection, from 2 to 65535 ms. Default = 12 ms. Type in 30 ms.</p> <p>NOTE: This parameter can be set in the DTM for the communication module or the remote device.</p>						
Time-out Multiplier	<p>This setting, multiplied against the RPI, produces a value that triggers an inactivity timeout. Setting selections include: x4, x8, x16, x32, x64, x128, x256 and x512.</p> <p>Accept the default of x4.</p>						
5	Click OK to save your settings.						

Configuring Connection Settings in the Remote Device DTM

Connections between a communication module and remote device can be created and edited in the DTM for the remote device.

In this example, the following configuration edits are made to the connection that Control Expert automatically created, when the remote device was added to the project. Use settings that are appropriate for your actual application:

Step	Action										
1	<p>Open the DTM for the remote device—in this example NIC2212_01—by selecting it in the Device Editor, then do one of the following:</p> <ul style="list-style-type: none"> ● in the main menu, select Edit → Open, or ● click the right mouse button, and select Open in the pop-up menu <p>The remote device DTM opens in the Device Editor.</p>										
2	<p>In the navigation pane (on the left side of the Device Editor), confirm that the remote device connection is of the type Read Input / Write Output Data. To view the connection type, select NIC2212_01 in the left pane of the Device Editor. If the connection type is not of the type Read Input / Write Output Data, delete the existing connection and add a new one, as follows:</p> <table border="1" data-bbox="193 678 1230 941"> <tbody> <tr> <td data-bbox="193 678 367 743">a</td> <td data-bbox="367 678 1230 743">With the connection selected in the left pane, click the Remove Connection button. The existing connection is removed.</td> </tr> <tr> <td data-bbox="193 743 367 776">b</td> <td data-bbox="367 743 1230 776">Click the Add Connection button. The Select the connection to add dialog opens.</td> </tr> <tr> <td data-bbox="193 776 367 846">c</td> <td data-bbox="367 776 1230 846">Use the scroll buttons on the drop down list to display and select the Read Input / Write Output Data connection type.</td> </tr> <tr> <td data-bbox="193 846 367 911">d</td> <td data-bbox="367 846 1230 911">Click OK to close the Select the connection to add dialog. The new connection node appears.</td> </tr> <tr> <td data-bbox="193 911 367 941">e</td> <td data-bbox="367 911 1230 941">Click Apply to save the new connection, leaving the Device Editor open for additional edits.</td> </tr> </tbody> </table>	a	With the connection selected in the left pane, click the Remove Connection button. The existing connection is removed.	b	Click the Add Connection button. The Select the connection to add dialog opens.	c	Use the scroll buttons on the drop down list to display and select the Read Input / Write Output Data connection type.	d	Click OK to close the Select the connection to add dialog. The new connection node appears.	e	Click Apply to save the new connection, leaving the Device Editor open for additional edits.
a	With the connection selected in the left pane, click the Remove Connection button. The existing connection is removed.										
b	Click the Add Connection button. The Select the connection to add dialog opens.										
c	Use the scroll buttons on the drop down list to display and select the Read Input / Write Output Data connection type.										
d	Click OK to close the Select the connection to add dialog. The new connection node appears.										
e	Click Apply to save the new connection, leaving the Device Editor open for additional edits.										

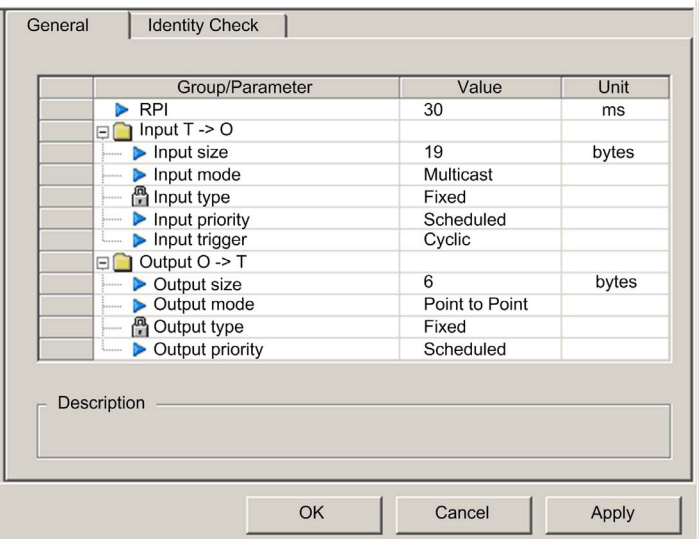
Step	Action																																							
3	<p data-bbox="223 203 994 227">With the Read Input / Write Output Data node selected, click on the General tab:</p>  <table border="1" data-bbox="274 308 905 592"> <thead> <tr> <th>Group/Parameter</th> <th>Value</th> <th>Unit</th> </tr> </thead> <tbody> <tr> <td>▶ RPI</td> <td>30</td> <td>ms</td> </tr> <tr> <td>[-] Input T -> O</td> <td></td> <td></td> </tr> <tr> <td>▶ Input size</td> <td>19</td> <td>bytes</td> </tr> <tr> <td>▶ Input mode</td> <td>Multicast</td> <td></td> </tr> <tr> <td>▶ Input type</td> <td>Fixed</td> <td></td> </tr> <tr> <td>▶ Input priority</td> <td>Scheduled</td> <td></td> </tr> <tr> <td>▶ Input trigger</td> <td>Cyclic</td> <td></td> </tr> <tr> <td>[-] Output O -> T</td> <td></td> <td></td> </tr> <tr> <td>▶ Output size</td> <td>6</td> <td>bytes</td> </tr> <tr> <td>▶ Output mode</td> <td>Point to Point</td> <td></td> </tr> <tr> <td>▶ Output type</td> <td>Fixed</td> <td></td> </tr> <tr> <td>▶ Output priority</td> <td>Scheduled</td> <td></td> </tr> </tbody> </table> <p data-bbox="274 625 905 690">Description _____</p> <p data-bbox="487 722 919 763"> <input type="button" value="OK"/> <input type="button" value="Cancel"/> <input type="button" value="Apply"/> </p>	Group/Parameter	Value	Unit	▶ RPI	30	ms	[-] Input T -> O			▶ Input size	19	bytes	▶ Input mode	Multicast		▶ Input type	Fixed		▶ Input priority	Scheduled		▶ Input trigger	Cyclic		[-] Output O -> T			▶ Output size	6	bytes	▶ Output mode	Point to Point		▶ Output type	Fixed		▶ Output priority	Scheduled	
Group/Parameter	Value	Unit																																						
▶ RPI	30	ms																																						
[-] Input T -> O																																								
▶ Input size	19	bytes																																						
▶ Input mode	Multicast																																							
▶ Input type	Fixed																																							
▶ Input priority	Scheduled																																							
▶ Input trigger	Cyclic																																							
[-] Output O -> T																																								
▶ Output size	6	bytes																																						
▶ Output mode	Point to Point																																							
▶ Output type	Fixed																																							
▶ Output priority	Scheduled																																							

Step	Action	
4	In the General page, edit the following settings:	
RPI	The refresh period for this connection. Accept the value of 30 ms . (This parameter can be set in the DTM for the communication module or the remote device.)	
Input size	The number of bytes reserved for input data, from 0 to 505. Type in 19 . NOTE: Control Expert reserves input data in increments of 4 bytes (2 words). In this example, typing in the value of 19 bytes reserve 20 bytes of input memory.	
Input mode	The transmission type: <ul style="list-style-type: none"> ● Multicast ● Point to Point Accept the default selection of Multicast .	
Input type	Ethernet packet type—fixed or variable length—to be transmitted. Only Fixed length packets are supported.	
Input priority	The transmission priority. The value depends upon the device DTM. Values can include: <ul style="list-style-type: none"> ● Low ● High ● Scheduled NOTE: For remote modules that support more than one priority value, you can use this setting to specify the order in which the Ethernet communication module will handle packets. For more information, refer to the topic describing QoS Packet Prioritization (<i>see Quantum using EcoStruxure™ Control Expert, 140 NOC 771 01 Ethernet Communication Module, User Manual</i>). For the purpose of this example, accept the default selection of Scheduled .	
Input trigger	The transmission trigger. Values can include: <ul style="list-style-type: none"> ● Cyclic ● Change of state or application For input I/O data, select Cyclic .	
Output size	The number of bytes reserved for output data, from to 509. Type in 6 . NOTE: Control Expert reserves output data in increments of 4 bytes (2 words). In this example, typing in the value of 6 bytes reserves 8 bytes of output memory.	
Output mode	Accept the default selection of Point to Point .	
Output type	(Read-only). Only Fixed length packets are supported.	
Output priority	Accept the default selection of Scheduled .	

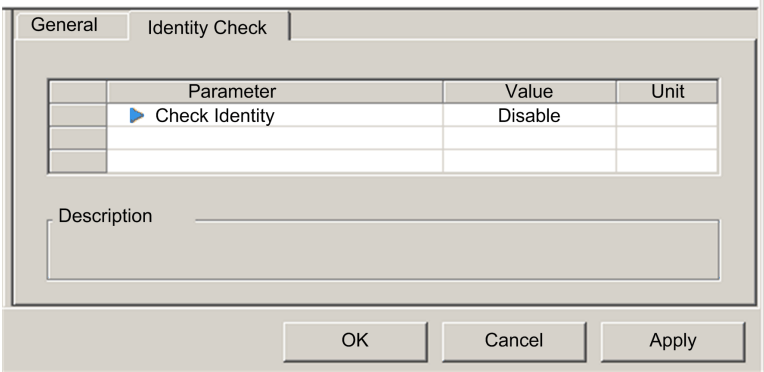
Step	Action										
5	<p>Click on the Identity Check tab to open the following page:</p> 										
6	<p>In the Identity Check page, set rules for comparing the identity of the remote device, as defined by its DTM or EDS file, against the identity of the actual remote device located on the network. Complete the following settings:</p> <table border="1" data-bbox="227 737 1249 1027"> <tr> <td data-bbox="227 737 395 1027">Check Identity</td> <td data-bbox="395 737 1249 1027"> <p>Define the rule Control Expert will use in comparing the configured versus the actual remote device. Settings include:</p> <ul style="list-style-type: none"> ● Must match exactly—the DTM or EDS file exactly matches the remote device ● Disable—no checking occurs; the identity portion of the connection is filled with zero values (the default setting) ● Must be compatible—if the remote device is not the same as defined by the DTM/EDS, it emulates the DTM/EDS definitions ● None—no checking occurs; the identity portion of the connection is omitted ● Custom—enables the following 6 parameter settings, to be set individually. <p>For this example, select Disable.</p> </td> </tr> </table> <p>If Check identity is set to Custom, complete the following 6 fields:</p> <table border="1" data-bbox="227 1068 1249 1365"> <tr> <td data-bbox="227 1068 395 1187">Compatibility Mode</td> <td data-bbox="395 1068 1249 1187"> <ul style="list-style-type: none"> ● True—for each of the following selected tests, the DTM/EDS and remote device need only be compatible ● False—for each of the following selected tests, the DTM/EDS and remote device need to match exactly </td> </tr> <tr> <td data-bbox="227 1195 395 1222">Minor Version</td> <td data-bbox="395 1195 1249 1365" rowspan="5"> <p>For each of the parameters to the left, select one of the following settings:</p> <ul style="list-style-type: none"> ● Compatible—include the parameter in the test ● Not checked—the parameter is not included in the test </td> </tr> <tr> <td data-bbox="227 1230 395 1258">Major Version</td> </tr> <tr> <td data-bbox="227 1266 395 1294">Product Code</td> </tr> <tr> <td data-bbox="227 1302 395 1330">Product Type</td> </tr> <tr> <td data-bbox="227 1338 395 1365">Product Vendor</td> </tr> </table>	Check Identity	<p>Define the rule Control Expert will use in comparing the configured versus the actual remote device. Settings include:</p> <ul style="list-style-type: none"> ● Must match exactly—the DTM or EDS file exactly matches the remote device ● Disable—no checking occurs; the identity portion of the connection is filled with zero values (the default setting) ● Must be compatible—if the remote device is not the same as defined by the DTM/EDS, it emulates the DTM/EDS definitions ● None—no checking occurs; the identity portion of the connection is omitted ● Custom—enables the following 6 parameter settings, to be set individually. <p>For this example, select Disable.</p>	Compatibility Mode	<ul style="list-style-type: none"> ● True—for each of the following selected tests, the DTM/EDS and remote device need only be compatible ● False—for each of the following selected tests, the DTM/EDS and remote device need to match exactly 	Minor Version	<p>For each of the parameters to the left, select one of the following settings:</p> <ul style="list-style-type: none"> ● Compatible—include the parameter in the test ● Not checked—the parameter is not included in the test 	Major Version	Product Code	Product Type	Product Vendor
Check Identity	<p>Define the rule Control Expert will use in comparing the configured versus the actual remote device. Settings include:</p> <ul style="list-style-type: none"> ● Must match exactly—the DTM or EDS file exactly matches the remote device ● Disable—no checking occurs; the identity portion of the connection is filled with zero values (the default setting) ● Must be compatible—if the remote device is not the same as defined by the DTM/EDS, it emulates the DTM/EDS definitions ● None—no checking occurs; the identity portion of the connection is omitted ● Custom—enables the following 6 parameter settings, to be set individually. <p>For this example, select Disable.</p>										
Compatibility Mode	<ul style="list-style-type: none"> ● True—for each of the following selected tests, the DTM/EDS and remote device need only be compatible ● False—for each of the following selected tests, the DTM/EDS and remote device need to match exactly 										
Minor Version	<p>For each of the parameters to the left, select one of the following settings:</p> <ul style="list-style-type: none"> ● Compatible—include the parameter in the test ● Not checked—the parameter is not included in the test 										
Major Version											
Product Code											
Product Type											
Product Vendor											
7	Click OK to save your settings.										

The next step is to configure I/O settings.

Connecting to the Advantys STB Island

Overview

In this example, you will use the Advantys configuration software running on your PC to:

- connect the Advantys configuration software to the STB NIC 2212 and the 8 I/O modules that comprise the Advantys STB island
- upload Advantys STB island configuration to the Advantys configuration software in your PC
- display a fieldbus image for the Advantys STB island showing the relative location of:
 - status information
 - input data
 - output data

Using the data presented in the fieldbus image, you can use Control Expert to create input and output items that map to specific status, input, output, and output echo data.

NOTE: Before proceeding with the following instructions, confirm that you have auto-configured the Advantys STB island by pressing the **RST** button on the front of the STB NIC 2212 module.

Making the Connection

To connect to the STB NIC 2212 and I/O modules using the Advantys configuration software:

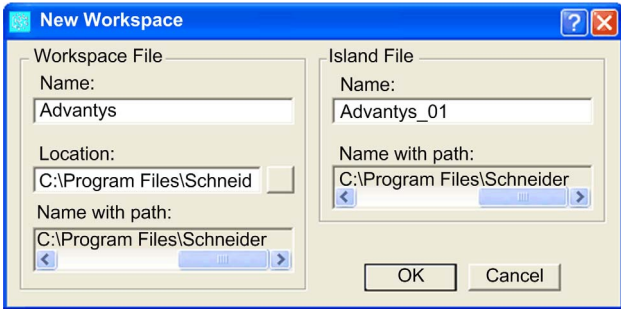
Step	Action
1	Startup the Advantys configuration software on your PC. A dialog opens displaying available project types.
2	Select STB .
3	Select File → New Workspace . The New Workspace window opens (below).
4	For this example, type in the following field values: <ul style="list-style-type: none"> ● for the field Workspace File type in Advantys ● for the field Island File type in Advantys_01 
5	Click OK . The Advantys configuration software displays an empty DIN rail in the center of the screen.
6	Select Online → Connection Settings . The Connection Settings window opens (below).

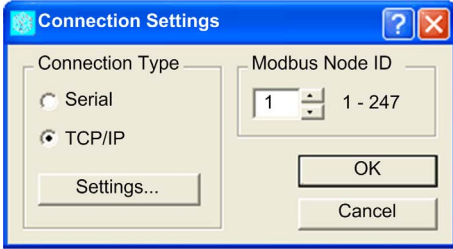
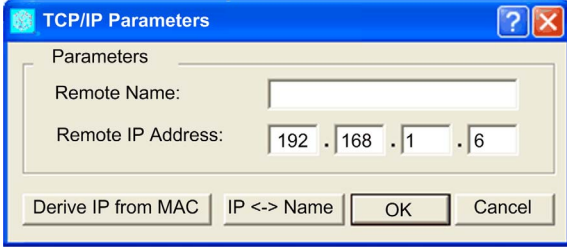
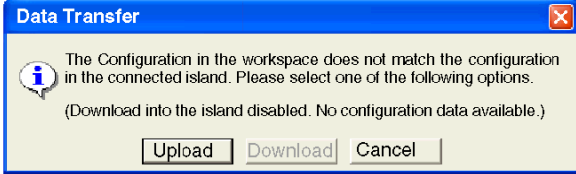
Step	Action
7	<p>In the Connection Settings window, accept the Modbus Node ID default setting of 1, select TCP/IP, and click the Settings... button:</p>  <p>The TCP/IP Parameters dialog opens (below).</p>
8	<p>In the Remote IP Address field, type in the IP address for the STB NIC 2212, in this example: 192.168.1.6.</p> 
9	<p>Click OK to close the TCP/IP Parameters dialog, and click OK again to close the Connection Settings dialog.</p>
10	<p>Select Online → Connect. The Data Transfer dialog opens (below):</p> 

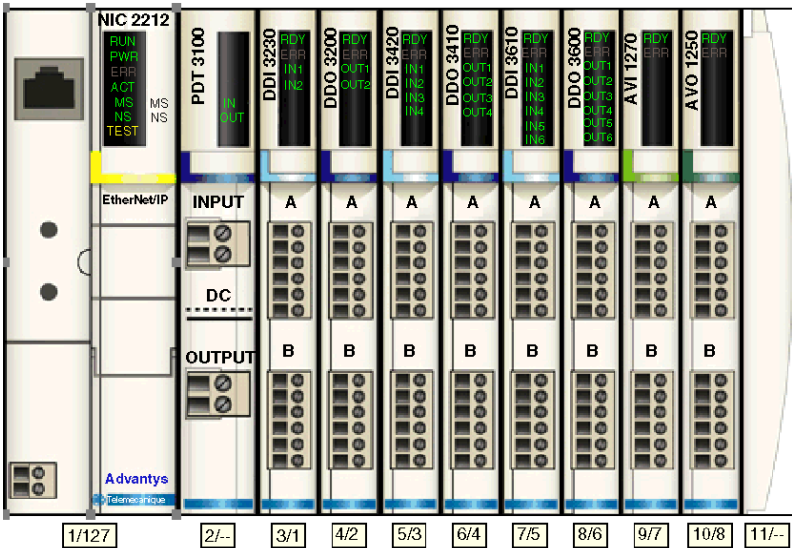
Step	Action
11	<p>Select Upload in the Data Transfer dialog. The island workspace is populated with island data and shows the STB NIC 2212 and the island modules (below):</p>  <p>Note: A box appears beneath each module containing one or two integers—for example 3/1. These integers serve the following purpose:</p> <ul style="list-style-type: none"> • The left-side integer (3 in this example) identifies the module's physical position—left to right—among the modules in the rack. • The right-side integer (1 in this example) identifies the module's relative position—left to right—among only data producing/receiving modules. If the module is not a data producing/receiving module (e.g. a power supply, or end of segment module) no right-side integer appears.

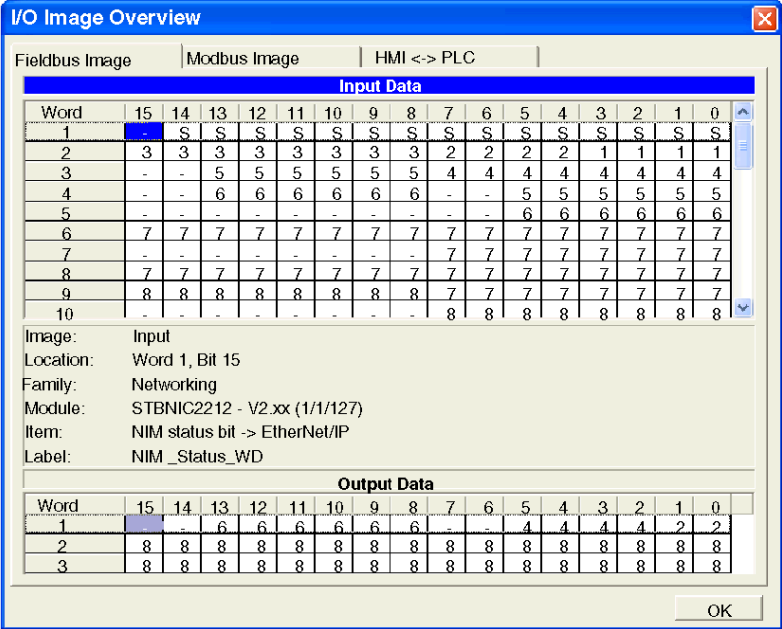
Step	Action
12	<p>Select Island → I/O Image Overview. The I/O Image window opens to the Fieldbus Image page:</p>  <p>Each table cell contains one of the following alpha-numeric indicators:</p> <ul style="list-style-type: none"> ● S indicates a status bit for the STB NIC 2212 network interface module ● an integer identifies the relative position—from left to right—of a data producing/receiving module with input or output data in that cell. For example: <ul style="list-style-type: none"> ○ the STB DDI 3230 input module is the first data producing or receiving module in the rack; its data is designated by the integer 1 in bits 0 - 3 of word 2 in the Input Data table ○ the STB DDO 3600 output module is the sixth data producing module in the rack; its status and output echo data is designated by the integer 6 in bits 8 - 13 of word 4 and in bits 0 - 5 of word 5 in the Input Data table; its output data is designated by the integer 6 in bits 8 - 13 of word 1 in the Output Data table <p>Notes: Select a cell in either the Input Data or Output Data tables to display—in the middle of the page—a description of the cell data and its source module. Convert the size of the Input Data table and the Output Data table from words to bytes (i.e. divide by 2), then use that data as the values for the Input Size (19) and Output Size (6) parameters when configuring the remote device's connection properties.</p>

Configuring I/O Items

Overview

The final task in this example is to add I/O items to the configuration of the STB NIC 2212 and its 8 I/O modules. To accomplish this:

- use the Advantys configuration software to identify the relative position of each I/O module's inputs and outputs
- use the Control Expert **Device Editor** to create input and output items, defining each item's:
 - name
 - data type

I/O Item Types and Sizes

The goal is to create a collection of input items and output items that equal the input size and output size specified for the STB NIC 2212 (*see Quantum using EcoStruxure™ Control Expert, 140 NOC 771 01 Ethernet Communication Module, User Manual*). In this example, items need to be created for:

- 19 bytes of inputs
- 6 bytes of outputs

The Control Expert **Device Editor** provides great flexibility in creating input and output items. You can create input and output items in groups of 1 or more single bits, 8-bit bytes, 16-bit words, 32-bit dwords, or 32-bit IEEE floating values. The number of items you create depends upon the data type and size of each item.

In the sample project, the following items were created:

- discrete bits for digital inputs and outputs
- 8-bit bytes or 16-bit words for analog inputs and outputs

Mapping Input and Output Items

Use the **Fieldbus Image** page of the **I/O Image Overview** window in the Advantys configuration software to identify the number and type of I/O items you need to create, as follows:

Step	Action
1	In the Advantys configuration software, select Island → I/O Image Overview . The I/O Image window opens to the Fieldbus Image page.
2	Select the first cell (word 1, cell 0) in the Input Data table to display—in the middle of the page—a description of the cell data and its source module.
3	Make a note of the word, bit(s), module and item information for that cell.
4	Repeat steps 2 and 3 for each cell containing either an S or an integer.

NOTE: The Fieldbus Image presents input and output data in the form of 16-bit words (starting with word 1). You need to rearrange this data for the Control Expert Ethernet Configuration Tool, which presents the same data in the form of 8-bit bytes (starting with byte 0).

NOTE: When you create items, align items of data type `WORD` and `DWORD`, as follows:

- `WORD` items: align these items on a 16-bit boundary
- `DWORD` items: align these items on a 32-bit boundary.

This process yields the following tables of input and output data:

Input Data:

Advantys Fieldbus Image		Control Expert EIP Items		STB Module	Description
Word	Bit(s)	Byte	Bit(s)		
1	0-15	0	0-7	NIC 2212	low byte status
		1	0-7		high byte status
2	0-1	2	0-1	DDI 3230	input data
	2-3		2-3	DDI 3230	input status
	4-5		4-5	DDO 3200	output data echo
	6-7		6-7	DDO 3200	output status
	8-11	3	0-3	DDI 3420	input data
	12-15		4-7	DDI 3420	input status
3	0-3	4	0-3	DDO 3410	output data echo
	4-7		4-7	DDO 3410	output status
	8-13	5	0-5	DDI 3610	input data
	14-15		6-7	NA	not used

Advantys Fieldbus Image		Control Expert EIP Items		STB Module	Description
Word	Bit(s)	Byte	Bit(s)		
4	0-5	6	0-5	DDI 3610	input status
	6-7		6-7	NA	not used
	8-13	7	0-5	DDO 3600	output data echo
	14-15		6-7	NA	not used
5	0-5	8	0-5	DDO 3600	output status
	6-15	8	6-7	NA	not used
		9	0-7		
6	0-15	10	0-7	AVI 1270	input data ch 1
		11	0-7		
7	0-7	12	0-7	AVI 1270	input status ch 1
	8-15	13	0-7	NA	not used
8	0-15	14	0-7	AVI 1270	input data ch 2
		15	0-7		
9	0-7	16	0-7	AVI 1270	input status ch 2
	8-15	17	0-7	AVO 1250	output status ch 1
10	0-7	18	0-7	AVO 1250	output status ch 2
	8-15	NA	NA	NA	not used

Output Data:

Advantys Fieldbus Image		Control Expert EIP Items		Module	Description
Word	Bit(s)	Byte	Bit(s)		
1	0-1	0	0-1	DDO 3200	output data
	2-5		2-5	DDO 3410	output data
	6-7		6-7	NA	not used
	8-13	1	0-5	DDO 3600	output data
	14-15		6-7	NA	not used
2	0-15	2	0-7	AVO 1250	output data ch 1
		3	0-7		
3	0-15	4	0-7	AVO 1250	output data ch 2
		5	0-7		

This example shows you how to create 19 bytes of inputs and 6 bytes of outputs. To more efficiently use space, this example creates items in the following sequence:

- input bit items
- input byte and word items
- output bit items
- output byte and word items

Creating Input Bit Items

To create input bit items for the STB NIC 2212 example, beginning with 16 discrete inputs for NIC 2212 status:

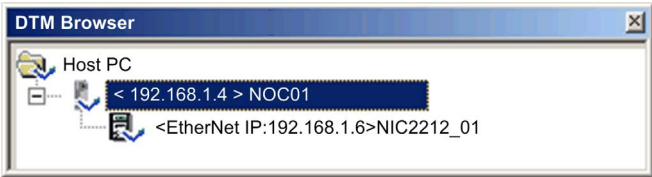
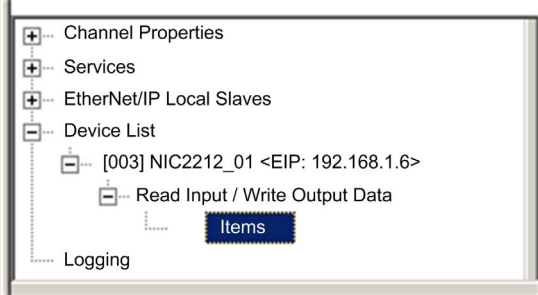
Step	Action
1	<p>In the DTM Browser, select the communication module:</p> 
2	<p>Do one of the following:</p> <ul style="list-style-type: none"> ● in the main menu, select Edit → Open, or ● click the right mouse button, then select Open in the pop-up menu. <p>The Device Editor opens, displaying the DTM for the communication module.</p>
3	<p>In the left pane of the Device Editor, navigate to and select the Items node for the STB NIC 2212 network interface module:</p> 

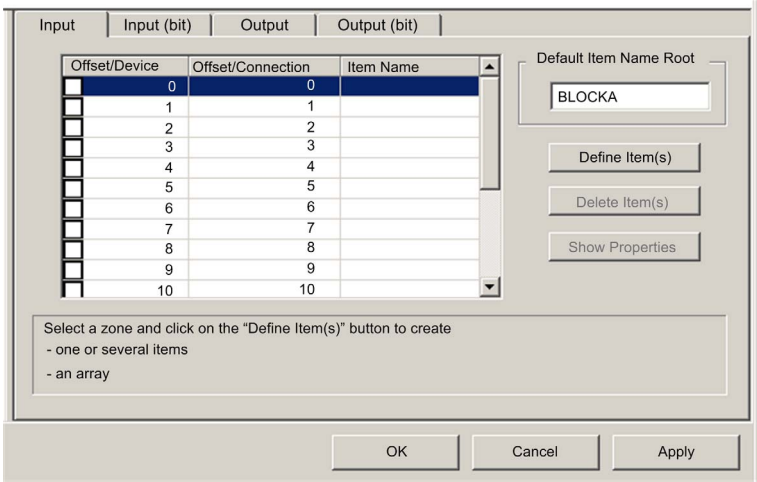
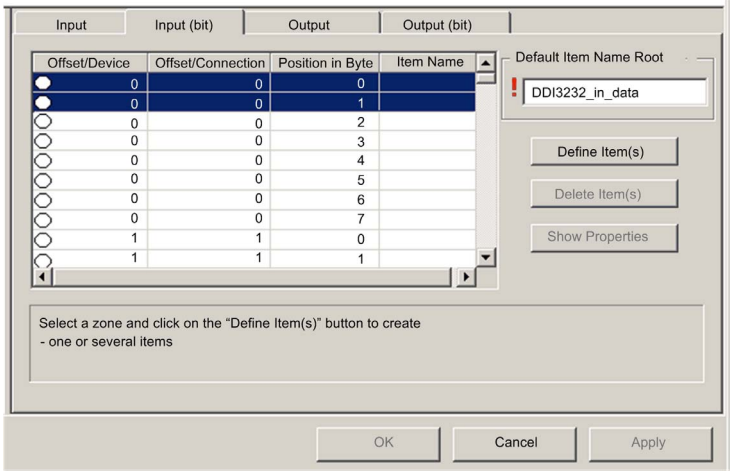
Step	Action
4	<p>The Items window opens:</p>  <p>Select a zone and click on the "Define Item(s)" button to create - one or several items - an array</p>
5	Select the Input (bit) tab to display that page.
6	In the Input (bit) page, type the following default root name—representing device status—into the Default Items Name Root input box type: DDI3232_in_data .
7	<p>In the Items List, select the first 2 rows in the table. (These rows represent bits 0-1 in byte.)</p>  <p>Select a zone and click on the "Define Item(s)" button to create - one or several items</p>

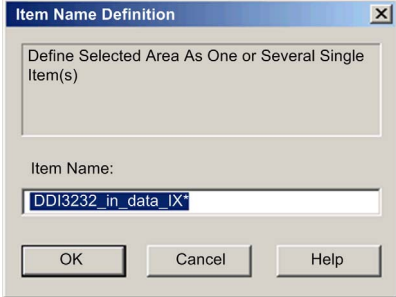
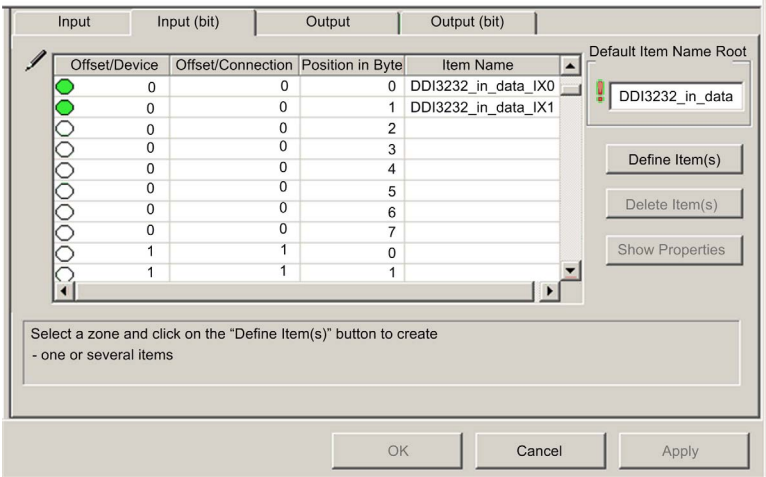
Step	Action																																																							
8	<p>Click the Define Item(s) button. The Item Name Definition dialog opens:</p>  <p>Note: The asterisk (*) indicates a series of discrete items with the same root name will be created.</p>																																																							
9	<p>Accept the default Item Name and click OK. 2 discrete input items are created:</p>  <table border="1" data-bbox="367 695 897 954"> <thead> <tr> <th>Input</th> <th>Input (bit)</th> <th>Output</th> <th>Output (bit)</th> <th>Item Name</th> </tr> </thead> <tbody> <tr> <td><input checked="" type="checkbox"/></td> <td>0</td> <td>0</td> <td>0</td> <td>DDI3232_in_data_IX0</td> </tr> <tr> <td><input checked="" type="checkbox"/></td> <td>0</td> <td>0</td> <td>1</td> <td>DDI3232_in_data_IX1</td> </tr> <tr> <td><input type="checkbox"/></td> <td>0</td> <td>0</td> <td>2</td> <td></td> </tr> <tr> <td><input type="checkbox"/></td> <td>0</td> <td>0</td> <td>3</td> <td></td> </tr> <tr> <td><input type="checkbox"/></td> <td>0</td> <td>0</td> <td>4</td> <td></td> </tr> <tr> <td><input type="checkbox"/></td> <td>0</td> <td>0</td> <td>5</td> <td></td> </tr> <tr> <td><input type="checkbox"/></td> <td>0</td> <td>0</td> <td>6</td> <td></td> </tr> <tr> <td><input type="checkbox"/></td> <td>0</td> <td>0</td> <td>7</td> <td></td> </tr> <tr> <td><input type="checkbox"/></td> <td>1</td> <td>1</td> <td>0</td> <td></td> </tr> <tr> <td><input type="checkbox"/></td> <td>1</td> <td>1</td> <td>1</td> <td></td> </tr> </tbody> </table> <p>Select a zone and click on the "Define Item(s)" button to create - one or several items</p>	Input	Input (bit)	Output	Output (bit)	Item Name	<input checked="" type="checkbox"/>	0	0	0	DDI3232_in_data_IX0	<input checked="" type="checkbox"/>	0	0	1	DDI3232_in_data_IX1	<input type="checkbox"/>	0	0	2		<input type="checkbox"/>	0	0	3		<input type="checkbox"/>	0	0	4		<input type="checkbox"/>	0	0	5		<input type="checkbox"/>	0	0	6		<input type="checkbox"/>	0	0	7		<input type="checkbox"/>	1	1	0		<input type="checkbox"/>	1	1	1	
Input	Input (bit)	Output	Output (bit)	Item Name																																																				
<input checked="" type="checkbox"/>	0	0	0	DDI3232_in_data_IX0																																																				
<input checked="" type="checkbox"/>	0	0	1	DDI3232_in_data_IX1																																																				
<input type="checkbox"/>	0	0	2																																																					
<input type="checkbox"/>	0	0	3																																																					
<input type="checkbox"/>	0	0	4																																																					
<input type="checkbox"/>	0	0	5																																																					
<input type="checkbox"/>	0	0	6																																																					
<input type="checkbox"/>	0	0	7																																																					
<input type="checkbox"/>	1	1	0																																																					
<input type="checkbox"/>	1	1	1																																																					
10	<p>Click Apply to save the items, and leave the page open.</p>																																																							

Step	Action
11	<p>Repeat steps 6 - 10 for each group of discrete input items you need to create. In this example, that includes items for each of the following groups:</p> <ul style="list-style-type: none"> ● Byte: 0, Bits: 2-3, Default Items Name Root: DDI3230_in_st ● Byte: 0, Bits: 4-5, Default Items Name Root: DDO3200_out_echo ● Byte: 0, Bits: 6-7, Default Items Name Root: DDO3200_out_st ● Byte: 1, Bits: 0-3, Default Items Name Root: DDI3420_in_data ● Byte: 1, Bits: 4-7, Default Items Name Root: DDI3420_in_st ● Byte: 2, Bits: 0-3, Default Items Name Root: DDO3410_out_echo ● Byte: 2, Bits: 4-7, Default Items Name Root: DDO3410_out_st ● Byte: 3, Bits: 0-5, Default Items Name Root: DDI3610_in_data ● Byte: 4, Bits: 0-5, Default Items Name Root: DDI3610_in_st ● Byte: 5, Bits: 0-5, Default Items Name Root: DDO3600_out_echo ● Byte: 6, Bits: 0-5, Default Items Name Root: DDO3600_out_st
12	The next task is to create input bytes and words.

Creating Input Items

To create input items for the STB NIC 2212 example, begin with an input data byte containing low byte status for the STB NIC 2212 module:

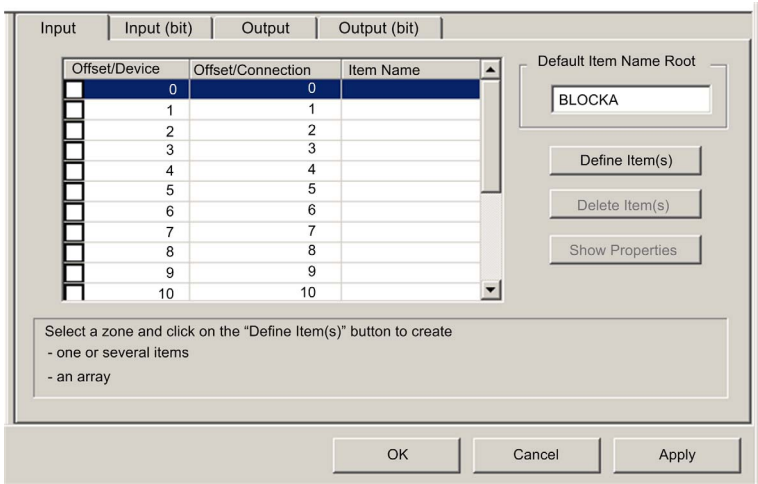
Step	Action
1	<p>Select the Input tab to return to that page:</p>  <p>NOTE: In this example, both the Offset/Device and Offset/Connection columns represent the byte address. The items you create will be either an 8-bit byte or a 16-bit word</p>
2	In the Default Item Name Root input box type: NIC22212_01_LO_st .

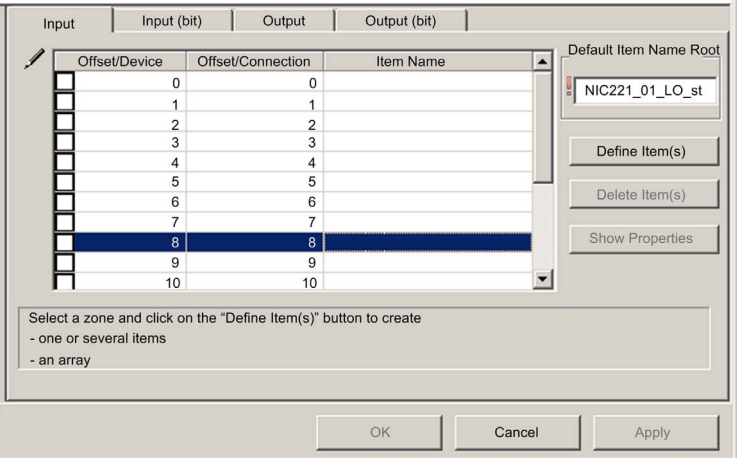
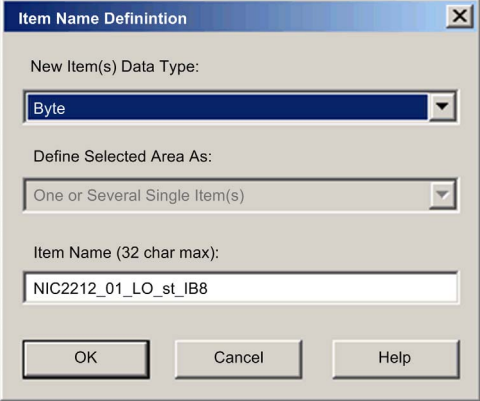
Step	Action
3	<p>Starting at the first available whole input word, select the single row at byte 8:</p>  <p>The screenshot shows a configuration window with a table and several buttons. The table has three columns: 'Offset/Device', 'Offset/Connection', and 'Item Name'. The rows are numbered 0 through 10. Row 8 is highlighted in blue. To the right of the table is a 'Default Item Name Root' field containing 'NIC221_01_LO_st'. Below this are three buttons: 'Define Item(s)', 'Delete Item(s)', and 'Show Properties'. At the bottom of the window are 'OK', 'Cancel', and 'Apply' buttons. A text box at the bottom of the window contains the following instructions:</p> <p>Select a zone and click on the "Define Item(s)" button to create - one or several items - an array</p>
4	<p>Click the Define Item(s) button. The Item Name Definition dialog opens:</p>  <p>The screenshot shows the 'Item Name Definition' dialog box. It has a title bar with a close button. The 'New Item(s) Data Type:' dropdown is set to 'Byte'. The 'Define Selected Area As:' dropdown is set to 'One or Several Single Item(s)'. The 'Item Name (32 char max):' text field contains 'NIC2212_01_LO_st_IB8'. At the bottom are 'OK', 'Cancel', and 'Help' buttons.</p>

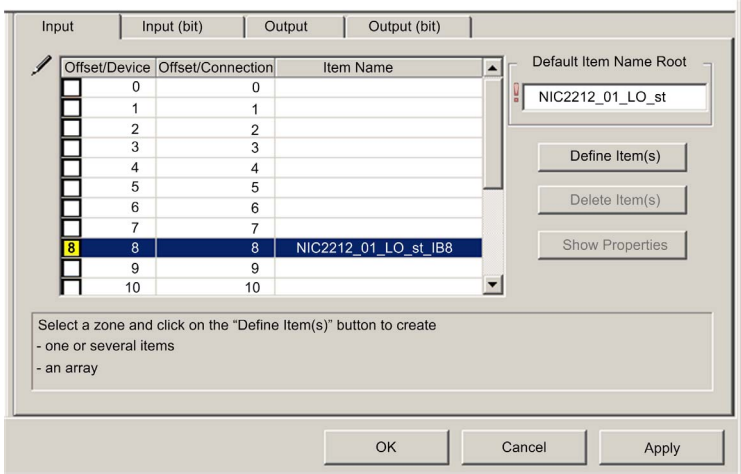
Step	Action
5	<p>Select Byte as the New Item(s) Data Type, then click OK. A new byte item is created:</p> 
6	Click Apply to save the new items, and leave the page open.
7	<p>Repeat steps 2 - 6 for each byte or word input item you need to create.</p> <p>NOTE: The number of rows you select for a new item depends upon the item type. If the item is a:</p> <ul style="list-style-type: none"> ● byte: select a single row ● word: select two rows, beginning at the next available whole word <p>In this example, you will create items for each of the following:</p> <ul style="list-style-type: none"> ● Byte: 9, Default Items Name Root: NIC2212_01_HI_st ● Word: 10, Default Items Name Root: AVI1270_CH1_in_data ● Byte: 12, Default Items Name Root: AVI1270_CH1_in_st ● Word: 14-15, Default Items Name Root: AVI1270_CH2_in_data ● Byte: 16, Default Items Name Root: AVI1270_CH2_in_st ● Byte: 17, Default Items Name Root: AVO1250_CH1_out_st ● Byte: 18, Default Items Name Root: AVO1250_CH2_out_st
8	The next task is to create output bits.

Creating Output Bit Items

To create output bit items for the STB NIC 2212 example, beginning with 2 output bits for the STB DDO3200 module:

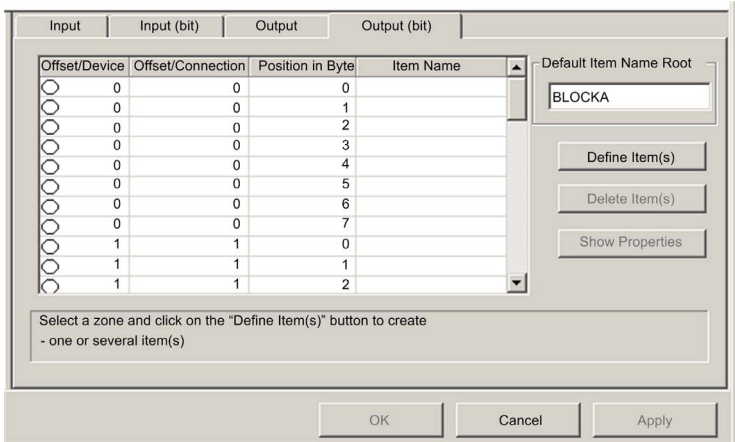
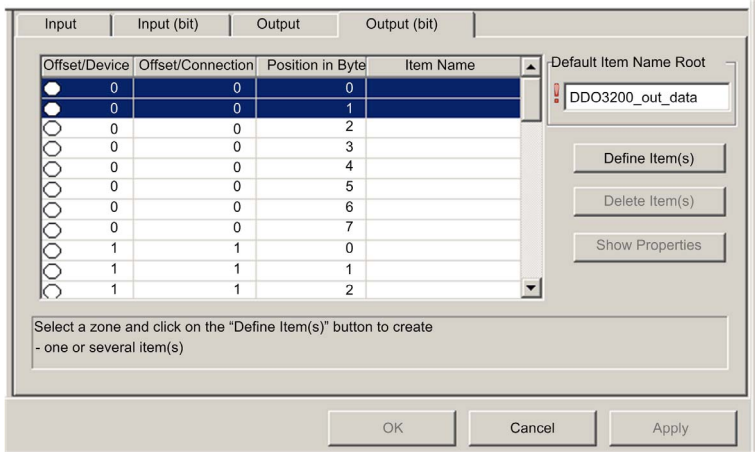
Step	Action
1	<p>Select the Output (bit) tab to open the following page:</p>  <p>NOTE: Both the Offset/Device and Offset/Connection columns represent the byte address of an output, while the Position in Byte column indicates the bit position—within the byte—of each discrete output item.</p>
2	In the Default Items Name Root input box type: DDO3200_out_data .
3	<p>In the Items List, select the rows that correspond to bits 0-1 in byte 0—i.e., the first 2 rows:</p> 

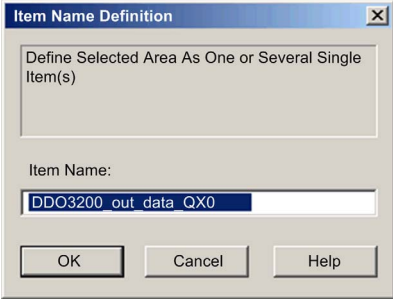
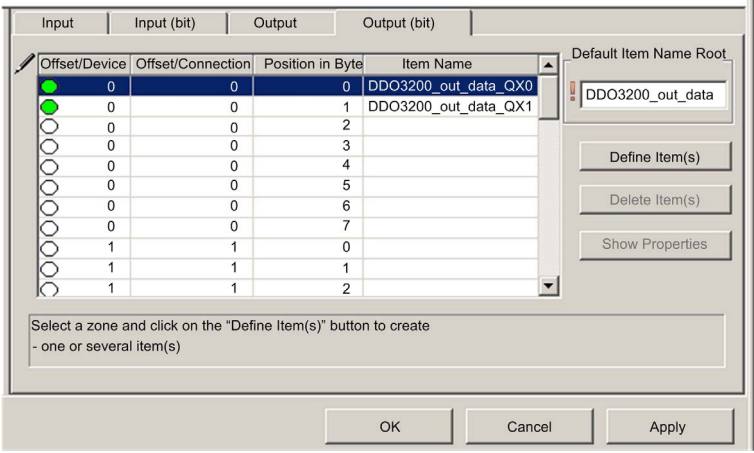
Step	Action																																																
4	<p>Click the Define Item(s) button. The Item Name Definition dialog opens:</p>  <p>NOTE: The asterisk (*) indicates a series of discrete items with the same root name will be created.</p>																																																
5	<p>Accept the default output name and click OK. 2 discrete output items are created:</p>  <table border="1" data-bbox="326 695 857 950"> <thead> <tr> <th>Offset/Device</th> <th>Offset/Connection</th> <th>Position in Byte</th> <th>Item Name</th> </tr> </thead> <tbody> <tr> <td>0</td> <td>0</td> <td>0</td> <td>DDO3200_out_data_QX0</td> </tr> <tr> <td>0</td> <td>0</td> <td>1</td> <td>DDO3200_out_data_QX1</td> </tr> <tr> <td>0</td> <td>0</td> <td>2</td> <td></td> </tr> <tr> <td>0</td> <td>0</td> <td>3</td> <td></td> </tr> <tr> <td>0</td> <td>0</td> <td>4</td> <td></td> </tr> <tr> <td>0</td> <td>0</td> <td>5</td> <td></td> </tr> <tr> <td>0</td> <td>0</td> <td>6</td> <td></td> </tr> <tr> <td>0</td> <td>0</td> <td>7</td> <td></td> </tr> <tr> <td>1</td> <td>1</td> <td>0</td> <td></td> </tr> <tr> <td>1</td> <td>1</td> <td>1</td> <td></td> </tr> <tr> <td>1</td> <td>1</td> <td>2</td> <td></td> </tr> </tbody> </table>	Offset/Device	Offset/Connection	Position in Byte	Item Name	0	0	0	DDO3200_out_data_QX0	0	0	1	DDO3200_out_data_QX1	0	0	2		0	0	3		0	0	4		0	0	5		0	0	6		0	0	7		1	1	0		1	1	1		1	1	2	
Offset/Device	Offset/Connection	Position in Byte	Item Name																																														
0	0	0	DDO3200_out_data_QX0																																														
0	0	1	DDO3200_out_data_QX1																																														
0	0	2																																															
0	0	3																																															
0	0	4																																															
0	0	5																																															
0	0	6																																															
0	0	7																																															
1	1	0																																															
1	1	1																																															
1	1	2																																															
6	<p>Click Apply to save the new items, and leave the page open.</p>																																																
7	<p>Repeat steps 2 - 6 for each group of discrete output items you need to create. In this example, that includes items for each of the following groups:</p> <ul style="list-style-type: none"> ● Byte: 0, Bits: 2-5, Default Items Name Root: DDO3410_out_data ● Byte: 1, Bits: 0-5, Default Items Name Root: DDO3600_out_data 																																																
8	<p>The next task is to create output bytes and words.</p>																																																

Creating Numeric Output Items

To create output items for the STB NIC 2212, example, beginning with an output data word for the STB AVO 1250 module:

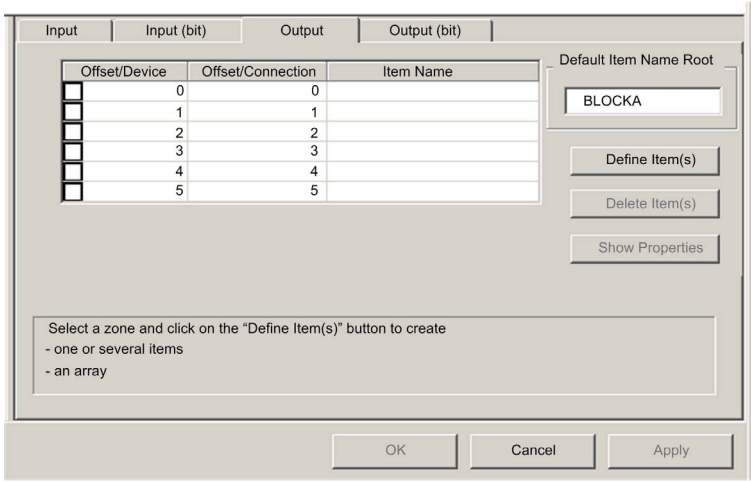
Step	Action
1	<p>Click on the Output tab to open the following page:</p>  <p>NOTE: In this example, both the Offset/Device and Offset/Connection columns represent the byte address. The items you create will be 16-bit words comprising 2 bytes.</p>
2	In the Default Item Name Root input box type: AVO1250_CH1_out_data .

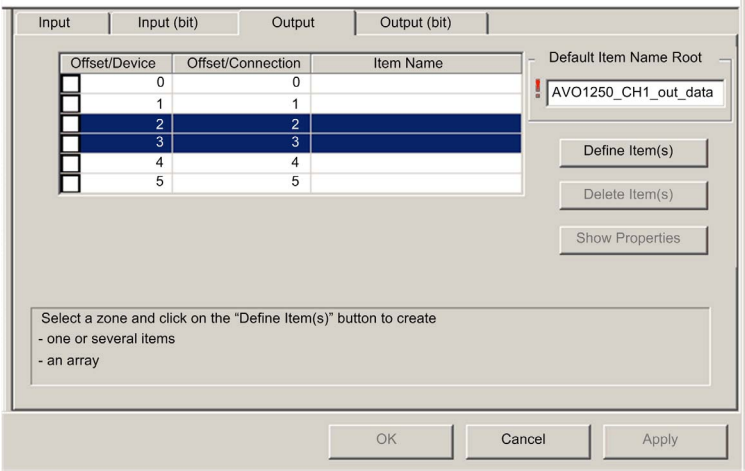
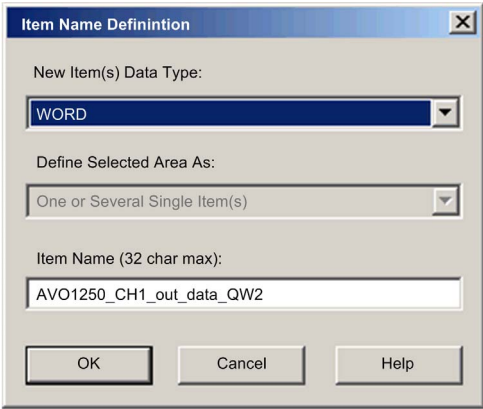
Step	Action
3	<p>Starting at the next available whole word, select 2 rows: 2 and 3:</p>  <p>The screenshot shows a configuration window with a table and several buttons. The table has three columns: 'Offset/Device', 'Offset/Connection', and 'Item Name'. The rows are numbered 0 to 5. Rows 2 and 3 are highlighted in blue. To the right of the table is a 'Default Item Name Root' field containing 'AVO1250_CH1_out_data'. Below this are three buttons: 'Define Item(s)', 'Delete Item(s)', and 'Show Properties'. At the bottom of the window are 'OK', 'Cancel', and 'Apply' buttons. A text box at the bottom of the window contains the following text:</p> <p>Select a zone and click on the "Define Item(s)" button to create - one or several items - an array</p>
4	<p>Click the Define Item(s) button. The Item Name Definition dialog opens:</p>  <p>The screenshot shows the 'Item Name Definition' dialog box. It has a title bar with a close button. The 'New Item(s) Data Type' dropdown is set to 'WORD'. The 'Define Selected Area As' dropdown is set to 'One or Several Single Item(s)'. The 'Item Name (32 char max):' text field contains 'AVO1250_CH1_out_data_QW2'. At the bottom are 'OK', 'Cancel', and 'Help' buttons.</p>

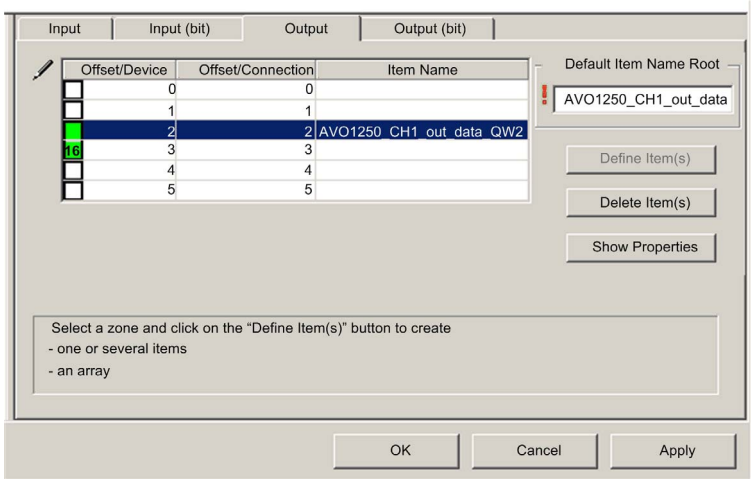
Step	Action
5	<p>Accept the default output name and click OK. the following output word item is created:</p> 
6	Click Apply to save the new item and leave the page open.
7	Repeat steps 2 - 6 for the AVO 1250 channel 2 output data at bytes 4 and 5.
8	Click OK to close the Items window.
9	Select File → Save to save your edits.

Section 3.3

Adding a Modbus TCP Device to the Network

Overview

This section extends the sample Control Expert application, by describing how to:

- add an STB NIP 2212 Modbus TCP network interface module to your Control Expert application
- configure the STB NIP 2212 module
- configure a Modbus TCP connection linking the BMX NOC 0401 communication module and the STB NIP 2212 network interface module

NOTE: The instructions in this chapter describe a single, specific device configuration example. Refer to the Control Expert help files for additional information about alternative configuration choices.

What Is in This Section?

This section contains the following topics:

Topic	Page
Setting Up Your Network	171
Adding an STB NIP 2212 Remote Device	173
Configuring STB NIP 2212 Properties	175
Connecting to the Advantys STB Island	183
Configuring I/O Items	187

Setting Up Your Network

Overview

This sample network includes the following hardware and software:

- a controller rack with:
 - BMX CPS 2000, 100/240 VAC power supply
 - BMX P34 20302 controller
 - BMX NOC 0401.2 Ethernet communication module
- a remote STB Advantys island with:
 - STB NIP 2212 Modbus TCP network interface module
 - STB PDT 3100 power distribution module
 - STB DDI 3230 2 pt digital input module
 - STB DDO 3200 2 pt digital output module
 - STB DDI 3420 4 pt digital input module
 - STB DDO 3410 4 pt digital output module
 - STB DDI 3610 6 pt digital input module
 - STB DDO 3600 6 pt digital output module
 - STB AVI 1270 2 pt analog input module
 - STB AVO 1250 2 pt analog output module
- a PC running both Unity Pro (version 5.0 or higher) and Advantys configuration software (version 5.0 or higher)
NOTE: Unity Pro is the former name of Control Expert for version 13.1 or earlier.
- an Ethernet managed switch that is connected to the both the controller and island by means of twisted pair Ethernet cable and RJ45 connectors.

Network Topology

The Ethernet network devices used in this configuration include the following:

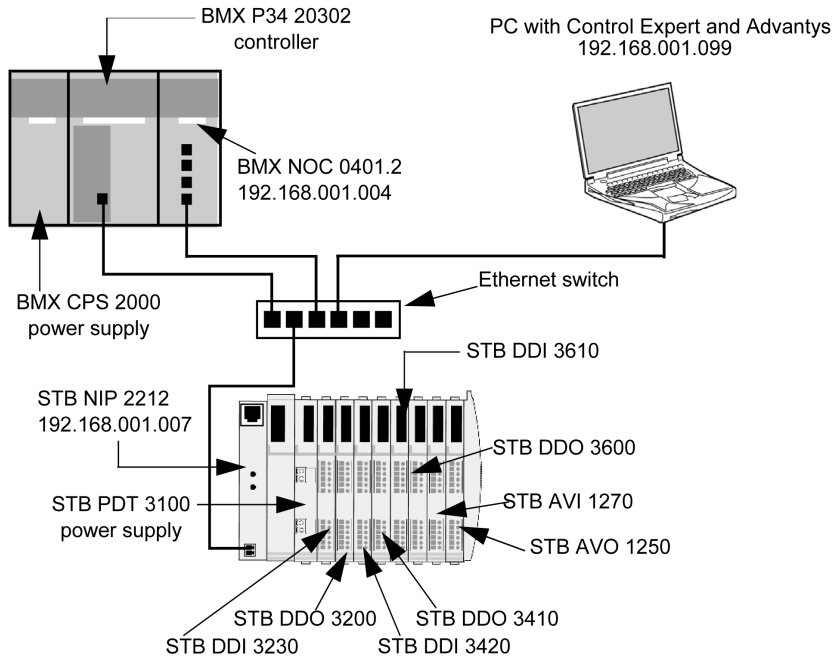

To re-create this example:

- use the IP addresses for your own configuration's:
 - PC
 - BMX NOC 0401.2 Ethernet communication module
 - STB NIP 2212 network interface module
- check wiring

NOTE: Control Expert software running in the PC is used to configure the BMX P34 20302 controller. In this example, the PC is indirectly wired to the CPU's Ethernet port via the Ethernet switch. Alternatively, you could bypass the switch and directly wire the PC to either the CPU's Modbus or USB ports.

Adding an STB NIP 2212 Remote Device

Overview

Use the generic Modbus DTM selection, in the **Add** dialog, to select and insert an STB NIP 2212 module to your project.

Adding an STB NIP 2212 Remote Device

To add the STB NIP 2212 to your project, follow these steps:

Step	Action																																				
1	In the DTM Browser , select the Ethernet communication module node, and then click the right mouse button. A pop-up menu opens.																																				
2	In the menu, select Add... The following dialog opens: <div data-bbox="330 589 1089 927" data-label="Image"> <table border="1"> <thead> <tr> <th>Device</th> <th>Type</th> <th>Vendor</th> <th>Version</th> </tr> </thead> <tbody> <tr> <td>Advanced Generic EDS</td> <td>Device</td> <td>Schneider Electric</td> <td>1.04.0001</td> </tr> <tr> <td>Generic Device</td> <td>Device</td> <td>Schneider Electric</td> <td>1.04.0001</td> </tr> <tr> <td>Generic Device for Explicit Messa...</td> <td>Device</td> <td>Schneider Electric</td> <td>1.04.0001</td> </tr> <tr> <td>Modbus Device</td> <td>Device</td> <td>Schneider Electric</td> <td>1.04.0001</td> </tr> <tr> <td>STBNIP2212 (from EDS)</td> <td>Device</td> <td>Schneider Electric</td> <td>2.10</td> </tr> <tr> <td>TCDEI-888N-D1U (from EDS)</td> <td>Device</td> <td>Molex Incorporated</td> <td>3.4</td> </tr> <tr> <td>TCDEI-888N-DYU (from EDS)</td> <td>Device</td> <td>Molex Incorporated</td> <td>3.4</td> </tr> <tr> <td>TCDEI-888P-D1U (from EDS)</td> <td>Device</td> <td>Molex Incorporated</td> <td>3.4</td> </tr> </tbody> </table> <p>The dialog box also contains an 'Add DTM' button and a 'Close' button.</p> </div>	Device	Type	Vendor	Version	Advanced Generic EDS	Device	Schneider Electric	1.04.0001	Generic Device	Device	Schneider Electric	1.04.0001	Generic Device for Explicit Messa...	Device	Schneider Electric	1.04.0001	Modbus Device	Device	Schneider Electric	1.04.0001	STBNIP2212 (from EDS)	Device	Schneider Electric	2.10	TCDEI-888N-D1U (from EDS)	Device	Molex Incorporated	3.4	TCDEI-888N-DYU (from EDS)	Device	Molex Incorporated	3.4	TCDEI-888P-D1U (from EDS)	Device	Molex Incorporated	3.4
Device	Type	Vendor	Version																																		
Advanced Generic EDS	Device	Schneider Electric	1.04.0001																																		
Generic Device	Device	Schneider Electric	1.04.0001																																		
Generic Device for Explicit Messa...	Device	Schneider Electric	1.04.0001																																		
Modbus Device	Device	Schneider Electric	1.04.0001																																		
STBNIP2212 (from EDS)	Device	Schneider Electric	2.10																																		
TCDEI-888N-D1U (from EDS)	Device	Molex Incorporated	3.4																																		
TCDEI-888N-DYU (from EDS)	Device	Molex Incorporated	3.4																																		
TCDEI-888P-D1U (from EDS)	Device	Molex Incorporated	3.4																																		
3	In the Add dialog, select the STBNIP2212 , then click Add DTM . The Properties window for the STB NIP 2212 network interface module opens.																																				

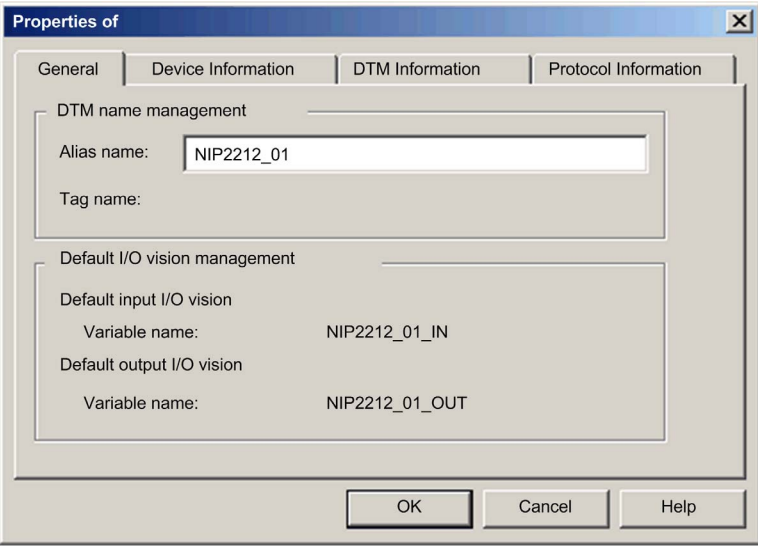
Step	Action
4	<p>In the General page of the Properties window, edit the default Alias name to read NIP2212_01:</p>  <p>When you edit the Alias name, Control Expert applies it as the base name for both structure and variable names.</p> <p>NOTE: No additional editing needs to be performed in the pages of this window. Except for the Alias name field, parameters are read-only.</p>
5	<p>Click OK. Control Expert adds the new STB NIP 2212 network interface module to the DTM Browser, beneath the communication module.</p>
6	<p>Refer to the topic <i>Configuring Properties in the Device Editor</i> (see page 57) for instructions on how to save your configuration edits.</p>

The next step is to configure the device you have just added to the project.

Configuring STB NIP 2212 Properties

Overview

Use the pages of the **Device Editor** to view and edit settings for a remote device. To edit the device settings, disconnect the DTM from the remote device (*see page 49*).

To display the DTM settings for a remote device, select the device name, which is found under the **Device List** node in the left pane of the **Device Editor**.

For the purposes of this example, which configures an STB NIP 2212 network interface module, select the node named **NIP2212_01**. The **Device Editor** displays the following pages:

- Properties
- Address Setting
- Request Setting

NOTE: Refer to the topic *Configuring Properties in the Device Editor* (*see page 57*) for instructions on how to edit properties.

Configuring the Properties Page

Use the **Properties** page to:

- add the remote device to, or remove it from, the configuration
- edit the base name for variables and data structures used by the remote device
- indicate how input and output items will be created and edited

The **Properties** page for an STB NIP 2212 network interface module looks like this:

The screenshot shows a configuration window with three tabs: "Properties", "Address Setting", and "Request Setting". The "Properties" tab is selected. The window is divided into several sections:

- Properties:** Contains a "Number:" field with a dropdown menu set to "004", an "Active Configuration:" field with a dropdown menu set to "Enabled", and a "Comment:" text area.
- IO Structure Name:** Contains a "Default Name" button. Below it are two sections:
 - Input:** Contains "Structure Name:" (T_NIP2212_01_IN) and "Variable Name:" (NIP2212_01_IN) text boxes.
 - Output:** Contains "Structure Name:" (T_NIP2212_01_OUT) and "Variable Name:" (NIP2212_01_OUT) text boxes.
- Items Management:** Contains an "Import Mode:" dropdown menu set to "Manual" and a "Reimport Items" button.

At the bottom of the window are three buttons: "OK", "Cancel", and "Apply".

The following settings are used in this sample configuration. Use settings that are appropriate for your actual application:

Step	Action	
1	In the Properties section of the page, edit the following:	
	Number	The relative position of the device in the list, from 0...127. For this example, accept the default of 004 .
	Active Configuration	<ul style="list-style-type: none"> ● Enabled: adds this device to the Control Expert project configuration ● Disabled: removes this device from the Control Expert project configuration Accept the default setting of Enabled .
2	In the IO Structure Name section of the page, edit the following:	
	Input area:	
	Structure Name	(Read-only) Control Expert automatically assigns a structure name based on the variable name, in this case T_NIP2212_01_IN .
	Variable Name	Accept the auto-generated variable name (based on the alias name <i>(see page 173)</i>): NIP2212_01_IN .
	Output area:	
	Structure Name	(Read-only) Control Expert automatically assigns a structure name based on the variable name, in this case T_NIP2212_01_OUT .
	Variable Name	Accept the auto-generated variable name (based on the alias name): NIP2212_01_OUT .
	Default Name button	Restores the default variable and structure names. For this example, custom names are used.
3	In the Items Management section of the page, edit the following:	
	Import mode	<ul style="list-style-type: none"> ● Automatic: I/O items are taken from the device DTM and updated if the items list in the device DTM changes. Items cannot be edited in the Device Editor. ● Manual: I/O items are manually added in the Device Editor. The I/O items list is not affected by changes to the device DTM. In this example, select Manual .
	Reimport Items	Imports the I/O items list from the device DTM, overwriting any manual I/O item edits. Enabled only when Import mode is set to Manual .
4	Click Apply to save your edits, and leave the window open for further edits.	

Configuring the Address Setting Page

Use the **Address Setting** page to:

- configure the IP address for the remote device
- enable, or disable, DHCP client software for the remote device

When the DHCP client software is enabled in the remote device, it will obtain its IP address from the DHCP server in the Ethernet communication module. The **Address Setting** page looks like this:

The screenshot shows a dialog box with three tabs: "Properties", "Address Setting" (which is selected), and "Request Setting". The "Address Setting" tab contains the following fields:

- Change Address:** IP Address: 192 . 168 . 1 . 7
- Address Server:**
 - DHCP for this device: Enabled (dropdown menu)
 - Identified by: Device Name (dropdown menu)
 - Identifier: NIP2212_01
 - Subnet Mask: 255 . 255 . 255 . 0
 - Gateway: 0 . 0 . 0 . 0

At the bottom of the dialog box are three buttons: "OK", "Cancel", and "Apply".

The following settings are used in this sample configuration. Use settings that are appropriate for your actual application:

Step	Action												
1	<p>In the Address Settings page, edit the following:</p> <table border="1" data-bbox="323 305 1249 1101"> <tr> <td data-bbox="323 305 594 492">IP Address</td> <td data-bbox="594 305 1249 492"> <p>By default:</p> <ul style="list-style-type: none"> the first three octet values equal the first three octet values of the Ethernet communication module, and the fourth octet value equals this device Number setting—in this case, 004. <p>In this example, the IP address is 192.169.1.7.</p> </td> </tr> <tr> <td data-bbox="323 492 594 678">DHCP for this Device</td> <td data-bbox="594 492 1249 678"> <ul style="list-style-type: none"> Enabled activates the DHCP client in this device. The device obtains its IP address from the DHCP service provided by the Ethernet communication module and appears on the auto-generated DHCP client list (<i>see page 82</i>). Disabled (the default) de-activates the DHCP client in this device. <p>Select Enabled.</p> </td> </tr> <tr> <td data-bbox="323 678 594 833">Identified by</td> <td data-bbox="594 678 1249 833"> <p>If DHCP for this Device is Enabled, this indicates the device identifier type:</p> <ul style="list-style-type: none"> MAC Address, or Device Name <p>Select Device Name.</p> </td> </tr> <tr> <td data-bbox="323 833 594 922">Identifier</td> <td data-bbox="594 833 1249 922"> <p>If DHCP for this Device is Enabled, the specific device MAC Address or Name value. Type in NIP2212_01.</p> </td> </tr> <tr> <td data-bbox="323 922 594 987">Mask</td> <td data-bbox="594 922 1249 987"> <p>The device subnet mask. The default = 255.255.255.0. Accept the default value.</p> </td> </tr> <tr> <td data-bbox="323 987 594 1101">Gateway</td> <td data-bbox="594 987 1249 1101"> <p>The gateway address used to reach this device. The default of 0.0.0.0 indicates this device is located on the same subnet as the Ethernet communication module. Accept the default value.</p> </td> </tr> </table>	IP Address	<p>By default:</p> <ul style="list-style-type: none"> the first three octet values equal the first three octet values of the Ethernet communication module, and the fourth octet value equals this device Number setting—in this case, 004. <p>In this example, the IP address is 192.169.1.7.</p>	DHCP for this Device	<ul style="list-style-type: none"> Enabled activates the DHCP client in this device. The device obtains its IP address from the DHCP service provided by the Ethernet communication module and appears on the auto-generated DHCP client list (<i>see page 82</i>). Disabled (the default) de-activates the DHCP client in this device. <p>Select Enabled.</p>	Identified by	<p>If DHCP for this Device is Enabled, this indicates the device identifier type:</p> <ul style="list-style-type: none"> MAC Address, or Device Name <p>Select Device Name.</p>	Identifier	<p>If DHCP for this Device is Enabled, the specific device MAC Address or Name value. Type in NIP2212_01.</p>	Mask	<p>The device subnet mask. The default = 255.255.255.0. Accept the default value.</p>	Gateway	<p>The gateway address used to reach this device. The default of 0.0.0.0 indicates this device is located on the same subnet as the Ethernet communication module. Accept the default value.</p>
IP Address	<p>By default:</p> <ul style="list-style-type: none"> the first three octet values equal the first three octet values of the Ethernet communication module, and the fourth octet value equals this device Number setting—in this case, 004. <p>In this example, the IP address is 192.169.1.7.</p>												
DHCP for this Device	<ul style="list-style-type: none"> Enabled activates the DHCP client in this device. The device obtains its IP address from the DHCP service provided by the Ethernet communication module and appears on the auto-generated DHCP client list (<i>see page 82</i>). Disabled (the default) de-activates the DHCP client in this device. <p>Select Enabled.</p>												
Identified by	<p>If DHCP for this Device is Enabled, this indicates the device identifier type:</p> <ul style="list-style-type: none"> MAC Address, or Device Name <p>Select Device Name.</p>												
Identifier	<p>If DHCP for this Device is Enabled, the specific device MAC Address or Name value. Type in NIP2212_01.</p>												
Mask	<p>The device subnet mask. The default = 255.255.255.0. Accept the default value.</p>												
Gateway	<p>The gateway address used to reach this device. The default of 0.0.0.0 indicates this device is located on the same subnet as the Ethernet communication module. Accept the default value.</p>												
2	Click Apply to save your edits, and leave the window open for further edits.												

The next step is to configure the connection between the communication module and the remote device.

Configuring the Request Setting Page

Use the **Request Setting** page to add, configure, and remove Modbus requests for the remote device. Each request represents a separate link between the communication module and the remote device.

The **Request Setting** page for an STB NIP 2212 network interface module looks like this:

Connection Bit	Unit ID	Health Time Out	Repetitive Rate	RD Address	RD Length	Last Value	WR Address	WR Length
0	255	1500	60	5391	18	Hold Value	0	5

The **Add Request** function is enabled only when **Import Mode** is set to **Manual**.

The following settings are used in this sample configuration. Use settings that are appropriate for your actual application:

Step	Action
1	In the Request Settings page, edit the following:
Connection Bit	<p>(Read-only) The offset for both the health bit and the control bit for this connection. Offset values are auto-generated by the Control Expert Ethernet Configuration Tool—starting at 0—based on the connection type, in the following order:</p> <ol style="list-style-type: none"> 1. Modbus TCP connections 2. Local Slave connections 3. EtherNet/IP connections <p>NOTE: When this Modbus TCP connection is created, the offset values for the previously created local slave and EtherNet/IP connections are incremented by 1: the local slave connection bit is set to 1, and the EtherNet/IP connection bit value is set to 2.</p>
Unit ID	<p>The number of the device, or module, that is the target of the connection. A value of:</p> <ul style="list-style-type: none"> ● 255 (the default) used to access the Ethernet communication module itself ● 254 causes no Modbus message to be sent; the module reports an event ● 0...253 identifies the device number of the target device, behind a Modbus TCP to Modbus gateway <p>NOTE: When accessing data in the Ethernet communication module itself, use 255. When accessing data in the application running in the PLC, use a value from 0 to 254 (a value of 1 is recommended).</p> <p>Because the remote device itself is the request target, accept the default value of 255.</p>
Health Timeout	<p>The maximum allowed period, in milliseconds, between device responses, from 0...120000 ms in increments of 5 ms. When this setting is exceeded, the health timeout bit is set to 1. The default = 1500 ms. Accept the default value of 1500.</p>
Repetitive Rate	<p>The data scan rate, from 0...60000 ms, in intervals of 5 ms. The default = 60 ms. Accept the default value of 60.</p>
RD Address	<p>Address in the remote device of the input data image. The input data image begins at word 45391. Because there is an offset of 40000 in the M340 platform, type in a value of 5391.</p>
RD Length	<p>The number of words in the remote device, from 0...125, that the communication module will read. Because the Modbus device will be configured for 18 words of input items, type in a value of 18.</p>
Last Value	<p>The behavior of inputs in the application in the event communication is lost:</p> <ul style="list-style-type: none"> ● Hold Value (the default) ● Set To Zero <p>Accept the default.</p>
WR Address	<p>Address in the remote device of the output data image. The output data image begins at word 40000. Because there is an offset of 40000 in the M340 platform, type in a value of 0.</p>

Step	Action	
	WR Length	The number of words in the remote device, from 0 to 120, to which the communication module will write. Because the Modbus device will be configured for 5 words of output items, type in a value of 5 .
2	Click OK to save your edits, and close the window.	

The next step is to connect the Control Expert project to the Advantys Island.

Connecting to the Advantys STB Island

Overview

In this example, you will use the Advantys configuration software running on your PC to:

- connect the Advantys configuration software to the STB NIP 2212 and the 8 I/O modules that comprise the Advantys STB island
- upload Advantys STB island configuration to the Advantys configuration software in your PC
- display a fieldbus image for the Advantys STB island showing the relative location of:
 - input data
 - output data

Using the data presented in the fieldbus image, you can use Control Expert to create input and output items that map to specific input, output, and output echo data.

NOTE: Before proceeding with the following instructions, confirm that you have auto-configured the Advantys STB island by pressing the **RST** button on the front of the STB NIP 2212 module.

Making the Connection

To connect to the STB NIP 2212 and I/O modules using the Advantys configuration software:

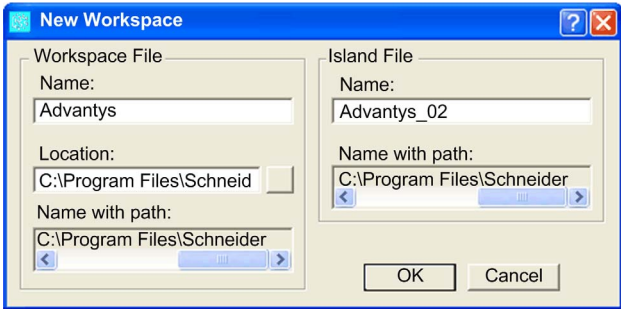
Step	Action
1	Startup the Advantys configuration software on your PC. A dialog opens displaying available project types.
2	Select STB .
3	Select File → New Workspace . The New Workspace window opens (below).
4	<p>For this example, type in the following field values:</p> <ul style="list-style-type: none"> ● for the field Workspace File type in Advantys ● for the field Island File type in Advantys_02
	
5	Click OK . The Advantys configuration software displays an empty DIN rail in the center of the screen.
6	Select Online → Connection Settings . The Connection Settings window opens (below).

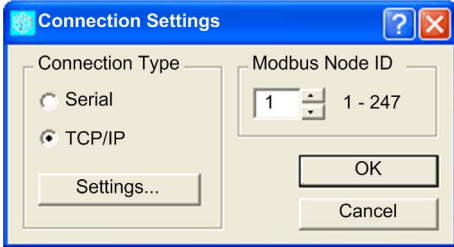
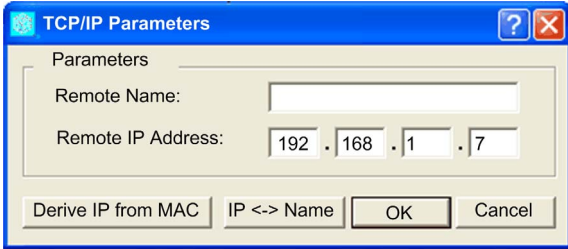
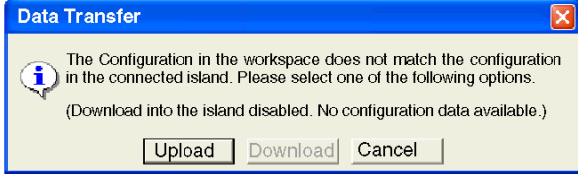
Step	Action
7	<p>In the Connection Settings window, accept the Modbus Node ID default setting of 1, select TCP/IP, and click the Settings... button:</p>  <p>The TCP/IP Parameters dialog opens (below).</p>
8	<p>In the Remote IP Address field, type in the IP address for the STB NIP 2212, in this example: 192.168.1.7.</p> 
9	<p>Click OK to close the TCP/IP Parameters dialog, and click OK again to close the Connection Settings dialog.</p>
10	<p>Select Online → Connect. The Data Transfer dialog opens (below):</p> 

Step	Action
11	Select Upload in the Data Transfer dialog. The island workspace is populated with island data and shows the STB NIP 2212 and the island modules (below):
<p>Note: A box appears beneath each module containing one or two integers—for example 3/1. These integers serve the following purpose:</p> <ul style="list-style-type: none"> • The left-side integer (3 in this example) identifies the module's physical position—left to right—among the modules in the rack. • The right-side integer (1 in this example) identifies the module's relative position—left to right—among only data producing/receiving modules. If the module is not a data producing/receiving module (e.g. a power supply, or end of segment module) no right-side integer appears. 	

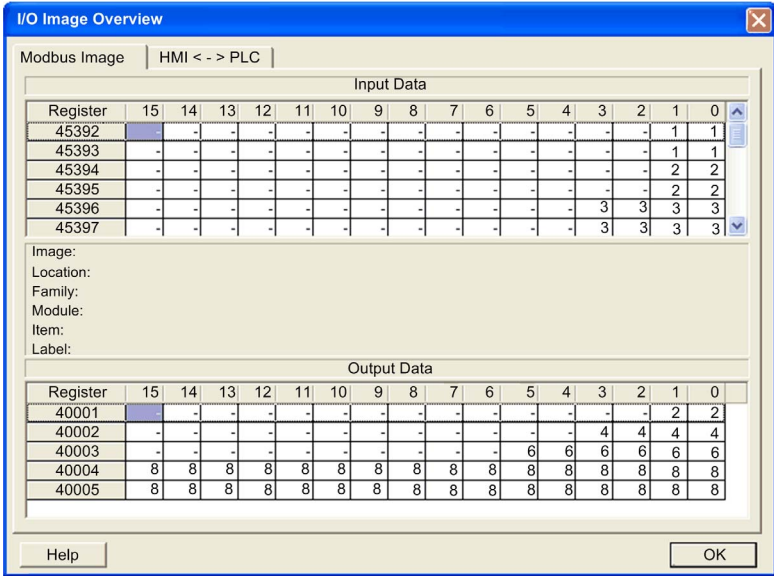
Step	Action																																																																																																																																																																																																																													
12	<p>Select Island → I/O Image Overview. The I/O Image window opens to the Fieldbus Image page:</p>  <p>The screenshot shows the 'I/O Image Overview' window with the following data:</p> <table border="1"> <caption>Input Data</caption> <thead> <tr> <th>Register</th> <th>15</th> <th>14</th> <th>13</th> <th>12</th> <th>11</th> <th>10</th> <th>9</th> <th>8</th> <th>7</th> <th>6</th> <th>5</th> <th>4</th> <th>3</th> <th>2</th> <th>1</th> <th>0</th> </tr> </thead> <tbody> <tr> <td>45392</td> <td>-</td> <td>-</td> <td>-</td> <td>-</td> <td>-</td> <td>-</td> <td>-</td> <td>-</td> <td>-</td> <td>-</td> <td>-</td> <td>-</td> <td>-</td> <td>-</td> <td>1</td> <td>1</td> </tr> <tr> <td>45393</td> <td>-</td> <td>-</td> <td>-</td> <td>-</td> <td>-</td> <td>-</td> <td>-</td> <td>-</td> <td>-</td> <td>-</td> <td>-</td> <td>-</td> <td>-</td> <td>-</td> <td>1</td> <td>1</td> </tr> <tr> <td>45394</td> <td>-</td> <td>-</td> <td>-</td> <td>-</td> <td>-</td> <td>-</td> <td>-</td> <td>-</td> <td>-</td> <td>-</td> <td>-</td> <td>-</td> <td>-</td> <td>-</td> <td>2</td> <td>2</td> </tr> <tr> <td>45395</td> <td>-</td> <td>-</td> <td>-</td> <td>-</td> <td>-</td> <td>-</td> <td>-</td> <td>-</td> <td>-</td> <td>-</td> <td>-</td> <td>-</td> <td>-</td> <td>-</td> <td>2</td> <td>2</td> </tr> <tr> <td>45396</td> <td>-</td> <td>-</td> <td>-</td> <td>-</td> <td>-</td> <td>-</td> <td>-</td> <td>-</td> <td>-</td> <td>-</td> <td>-</td> <td>-</td> <td>3</td> <td>3</td> <td>3</td> <td>3</td> </tr> <tr> <td>45397</td> <td>-</td> <td>-</td> <td>-</td> <td>-</td> <td>-</td> <td>-</td> <td>-</td> <td>-</td> <td>-</td> <td>-</td> <td>-</td> <td>-</td> <td>3</td> <td>3</td> <td>3</td> <td>3</td> </tr> </tbody> </table> <table border="1"> <caption>Output Data</caption> <thead> <tr> <th>Register</th> <th>15</th> <th>14</th> <th>13</th> <th>12</th> <th>11</th> <th>10</th> <th>9</th> <th>8</th> <th>7</th> <th>6</th> <th>5</th> <th>4</th> <th>3</th> <th>2</th> <th>1</th> <th>0</th> </tr> </thead> <tbody> <tr> <td>40001</td> <td>-</td> <td>-</td> <td>-</td> <td>-</td> <td>-</td> <td>-</td> <td>-</td> <td>-</td> <td>-</td> <td>-</td> <td>-</td> <td>-</td> <td>-</td> <td>-</td> <td>2</td> <td>2</td> </tr> <tr> <td>40002</td> <td>-</td> <td>-</td> <td>-</td> <td>-</td> <td>-</td> <td>-</td> <td>-</td> <td>-</td> <td>-</td> <td>-</td> <td>-</td> <td>-</td> <td>4</td> <td>4</td> <td>4</td> <td>4</td> </tr> <tr> <td>40003</td> <td>-</td> <td>-</td> <td>-</td> <td>-</td> <td>-</td> <td>-</td> <td>-</td> <td>-</td> <td>-</td> <td>-</td> <td>6</td> <td>6</td> <td>6</td> <td>6</td> <td>6</td> <td>6</td> </tr> <tr> <td>40004</td> <td>8</td> <td>8</td> <td>8</td> <td>8</td> <td>8</td> <td>8</td> <td>8</td> <td>8</td> <td>8</td> <td>8</td> <td>8</td> <td>8</td> <td>8</td> <td>8</td> <td>8</td> <td>8</td> </tr> <tr> <td>40005</td> <td>8</td> <td>8</td> <td>8</td> <td>8</td> <td>8</td> <td>8</td> <td>8</td> <td>8</td> <td>8</td> <td>8</td> <td>8</td> <td>8</td> <td>8</td> <td>8</td> <td>8</td> <td>8</td> </tr> </tbody> </table>	Register	15	14	13	12	11	10	9	8	7	6	5	4	3	2	1	0	45392	-	-	-	-	-	-	-	-	-	-	-	-	-	-	1	1	45393	-	-	-	-	-	-	-	-	-	-	-	-	-	-	1	1	45394	-	-	-	-	-	-	-	-	-	-	-	-	-	-	2	2	45395	-	-	-	-	-	-	-	-	-	-	-	-	-	-	2	2	45396	-	-	-	-	-	-	-	-	-	-	-	-	3	3	3	3	45397	-	-	-	-	-	-	-	-	-	-	-	-	3	3	3	3	Register	15	14	13	12	11	10	9	8	7	6	5	4	3	2	1	0	40001	-	-	-	-	-	-	-	-	-	-	-	-	-	-	2	2	40002	-	-	-	-	-	-	-	-	-	-	-	-	4	4	4	4	40003	-	-	-	-	-	-	-	-	-	-	6	6	6	6	6	6	40004	8	8	8	8	8	8	8	8	8	8	8	8	8	8	8	8	40005	8	8	8	8	8	8	8	8	8	8	8	8	8	8	8	8
Register	15	14	13	12	11	10	9	8	7	6	5	4	3	2	1	0																																																																																																																																																																																																														
45392	-	-	-	-	-	-	-	-	-	-	-	-	-	-	1	1																																																																																																																																																																																																														
45393	-	-	-	-	-	-	-	-	-	-	-	-	-	-	1	1																																																																																																																																																																																																														
45394	-	-	-	-	-	-	-	-	-	-	-	-	-	-	2	2																																																																																																																																																																																																														
45395	-	-	-	-	-	-	-	-	-	-	-	-	-	-	2	2																																																																																																																																																																																																														
45396	-	-	-	-	-	-	-	-	-	-	-	-	3	3	3	3																																																																																																																																																																																																														
45397	-	-	-	-	-	-	-	-	-	-	-	-	3	3	3	3																																																																																																																																																																																																														
Register	15	14	13	12	11	10	9	8	7	6	5	4	3	2	1	0																																																																																																																																																																																																														
40001	-	-	-	-	-	-	-	-	-	-	-	-	-	-	2	2																																																																																																																																																																																																														
40002	-	-	-	-	-	-	-	-	-	-	-	-	4	4	4	4																																																																																																																																																																																																														
40003	-	-	-	-	-	-	-	-	-	-	6	6	6	6	6	6																																																																																																																																																																																																														
40004	8	8	8	8	8	8	8	8	8	8	8	8	8	8	8	8																																																																																																																																																																																																														
40005	8	8	8	8	8	8	8	8	8	8	8	8	8	8	8	8																																																																																																																																																																																																														

Each table cell contains an integer that identifies the relative rack position of a data producing/receiving module with input or output data in that cell. For example:

- the STB DDI 3230 input module is the first data producing or receiving module in the rack; its data and status information is indicated by the integer 1 in bits 0...1 of registers 45392 and 45393 in the **Input Data** table
- the STB DDO 3600 output module is the sixth data producing module in the rack; its output echo and status data is designated by the integer 6 in bits 0 - 5 of register 45402 and in bits 0 - 5 of register 45403 in the **Input Data** table; its output data is designated by the integer 6 in bits 0 - 5 of register 40003 in the **Output Data** table

NOTE:

- Select a cell in either the **Input Data** or **Output Data** tables to display—in the middle of the page—a description of the cell data and its source module.
- Convert the size of the **Input Data** table and the **Output Data** table from words to bytes (i.e. divide by 2), then use that information when setting the **RD Length** (inputs) and **WR Length** (outputs) parameters in the **Request Setting** page for the remote Modbus TCP device.

Configuring I/O Items

Overview

The next task in this example is to add I/O items to the configuration of the STB NIP 2212 and its 8 I/O modules. To accomplish this:

- use the **Modbus Image** page of the Advantys configuration software to identify the relative position of each I/O module's inputs and outputs
- use the Control Expert **Device Editor** to create input and output items, defining each item's:
 - name
 - data type

NOTE: You can manually configure I/O items only when **Input Mode** is set to **Manual**.

I/O Item Types and Sizes

Because the Modbus TCP network interface module transmits data in the form of 16-bit words, in this example you will create every input and output item using the **WORD** data type. This remains true even if the item contains only a few bits of data. Bit-packing is not permitted when, as in this example, the remote device is a Modbus TCP network interface module.

NOTE: When you add more devices to your network, it may be necessary to increase the size and index location of both inputs and outputs for your Control Expert project (*see page 38*).

In this example, the following number and type of items need to be created:

- 18 input words
- 5 output words

Mapping Input and Output Items

Use the **Fieldbus Image** page of the **I/O Image Overview** window in the Advantys configuration software to identify the number and type of I/O items you need to create, as follows:

Step	Action
1	In the Advantys configuration software, select Island → I/O Image Overview . The I/O Image window opens to the Modbus Image page.
2	Select the cell 0 of the first word (45392) in the Input Data table to display—in the middle of the page—a description of the cell data and its source module.
3	Make a note of the register number and item information for that word.
4	Repeat steps 2 and 3 for each word.

NOTE: The Modbus Image presents input and output data in the form of 16-bit words (starting with word 1). You need to maintain this data format as you create input and output items in Control Expert.

NOTE: When you create items, align items of data type `WORD` and `DWORD`, as follows:

- `WORD` items: align these items on a 16-bit boundary
- `DWORD` items: align these items on a 32-bit boundary

This process yields the following tables of input and output data:

Input Data (Read):

Advantys Modbus Image		Control Expert Items		STB Module	Description
Register	Bit(s)	Bytes	Bit(s)		
45392	0-1	0	0-1	DDI 3230	input data
		1	not used		
45393	0-1	2	0-1	DDI 3230	input status
		3	not used		
45394	0-1	4	0-1	DDO 3200	output data echo
		5	not used		
45395	0-1	6	0-1	DDO 3200	output status
		7	not used		
45396	0-3	8	0-3	DDI 3420	input data
		9	not used		
45397	0-3	10	0-3	DDI 3420	input status
		11	not used		
45398	0-3	12	0-3	DDO 3410	output data echo
		13	not used		
45399	0-3	14	0-3	DDO 3410	output status
		15	not used		
45400	0-5	16	0-5	DDI 3610	input data
		17	not used		
45401	0-5	18	0-5	DDI 3610	input status
		19	not used		
45402	0-5	20	0-5	DDO 3600	output data echo
		21	not used		
45403	0-5	22	0-5	DDO 3600	output status
		23	not used		
45404	0-15	24	0-7	AVI 1270	input data ch 1
		25	0-7		
45405	0-7	26	0-7	AVI 1270	input status ch 1
		27	not used		

Advantys Modbus Image		Control Expert Items		STB Module	Description
Register	Bit(s)	Bytes	Bit(s)		
45406	0-15	28	0-7	AVI 1270	input data ch 2
		29	0-7		
45407	0-7	30	0-7	AVI 1270	input status ch 2
		31	not used		
45408	0-7	32	0-7	AVI 1270	output status ch 1
		33	not used		
45409	0-7	34	0-7	AVI 1270	output status ch 2
		35	not used		

Output Data (Write):

Advantys Modbus Image		Control Expert Items		STB Module	Description
Register	Bit(s)	Byte	Bit(s)		
40001	0-1	0	0-1	DDO 3200	output data
		1	not used		
40002	0-3	2	0-3	DDO 3410	output data
		3	not used		
40003	0-5	4	0-5	DDO 3600	output data
		5	not used		
40004	0-15	6	0-7	AVO 1250	output data ch 1
		7	0-7		
40005	0-15	8	0-7	AVO 1250	output data ch 2
		9	0-7		

This example shows you how to create 18 words of inputs and 5 words of outputs. This example creates items in the following sequence:

- input word items
- output word items

Creating Input Word Items

To create input items for the STB NIP 2212 example, beginning with an input word for the DDI 3230 input module:

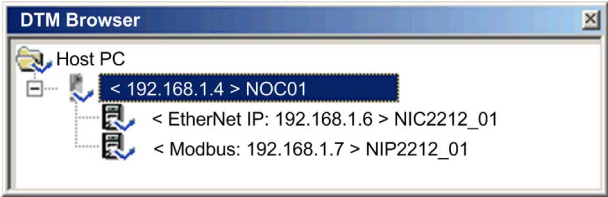
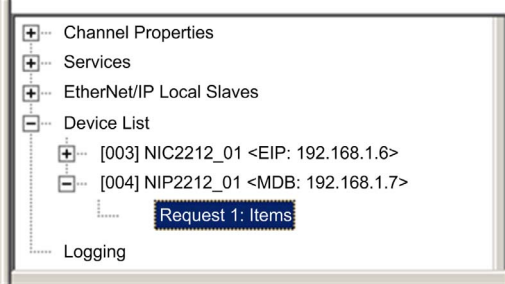
Step	Action
1	<p>In the DTM Browser, select the communication module:</p> 
2	<p>Do one of the following:</p> <ul style="list-style-type: none"> ● in the main menu, select Edit → Open, or ● click the right mouse button, then select Open in the pop-up menu. <p>The Device Editor opens, displaying the DTM for the communication module.</p>
3	<p>In the left pane of the Device Editor, navigate to and select the Items node for the STB NIP 2212 network interface module:</p> 

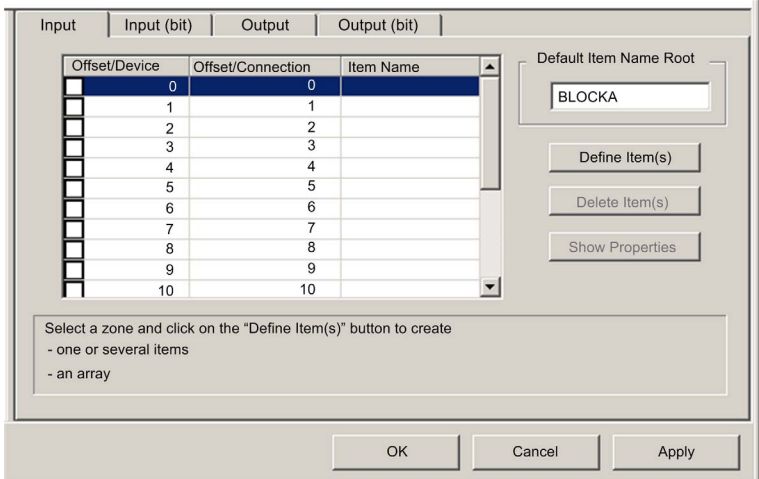
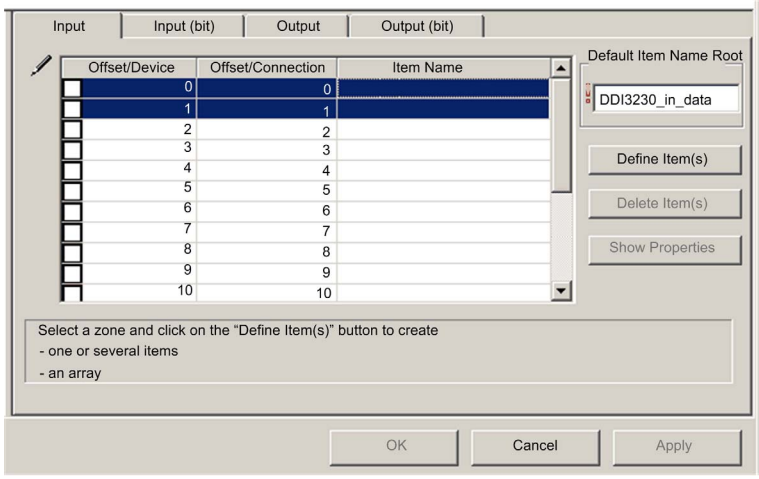
Step	Action
4	<p>Select the Input tab to open that page:</p>  <p>NOTE: In this example, each row represents a byte. Because the items you create will be a 16-bit word, each item consists of 2 rows.</p>
5	<p>In the Default Item Name Root input box type: DDI3230_in_data.</p>
6	<p>Starting at the beginning of the table, select the first two rows: 0 and 1:</p> 

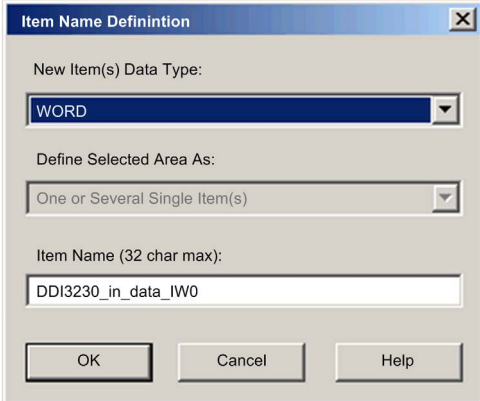
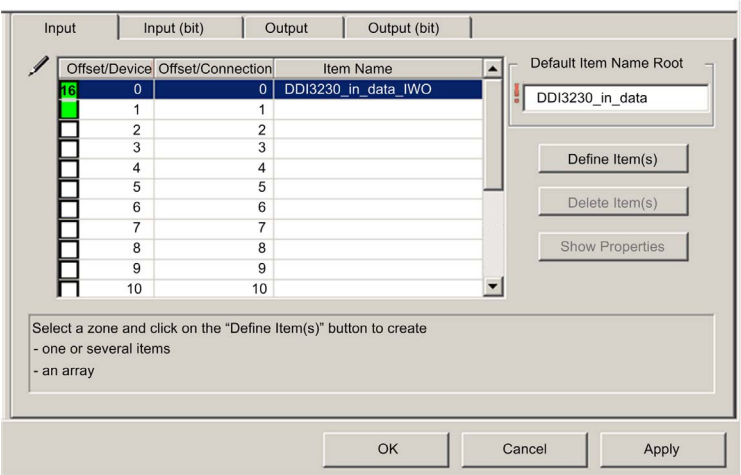
Step	Action																																																												
7	<p>Click the Define Item(s) button. The Item Name Definition dialog opens:</p>  <p>NOTE: The Define Item(s) button is enabled only when Input Mode is set to Manual.</p>																																																												
8	<p>Select WORD as the New Item(s) Data Type, then click OK. A new item is created:</p>  <table border="1" data-bbox="288 755 788 1047"> <thead> <tr> <th>Input</th> <th>Input (bit)</th> <th>Output</th> <th>Output (bit)</th> <th>Item Name</th> </tr> </thead> <tbody> <tr> <td>16</td> <td>0</td> <td>0</td> <td>0</td> <td>DDI3230_in_data_IW0</td> </tr> <tr> <td></td> <td>1</td> <td>1</td> <td>1</td> <td></td> </tr> <tr> <td></td> <td>2</td> <td>2</td> <td>2</td> <td></td> </tr> <tr> <td></td> <td>3</td> <td>3</td> <td>3</td> <td></td> </tr> <tr> <td></td> <td>4</td> <td>4</td> <td>4</td> <td></td> </tr> <tr> <td></td> <td>5</td> <td>5</td> <td>5</td> <td></td> </tr> <tr> <td></td> <td>6</td> <td>6</td> <td>6</td> <td></td> </tr> <tr> <td></td> <td>7</td> <td>7</td> <td>7</td> <td></td> </tr> <tr> <td></td> <td>8</td> <td>8</td> <td>8</td> <td></td> </tr> <tr> <td></td> <td>9</td> <td>9</td> <td>9</td> <td></td> </tr> <tr> <td></td> <td>10</td> <td>10</td> <td>10</td> <td></td> </tr> </tbody> </table> <p>Select a zone and click on the "Define Item(s)" button to create - one or several items - an array</p>	Input	Input (bit)	Output	Output (bit)	Item Name	16	0	0	0	DDI3230_in_data_IW0		1	1	1			2	2	2			3	3	3			4	4	4			5	5	5			6	6	6			7	7	7			8	8	8			9	9	9			10	10	10	
Input	Input (bit)	Output	Output (bit)	Item Name																																																									
16	0	0	0	DDI3230_in_data_IW0																																																									
	1	1	1																																																										
	2	2	2																																																										
	3	3	3																																																										
	4	4	4																																																										
	5	5	5																																																										
	6	6	6																																																										
	7	7	7																																																										
	8	8	8																																																										
	9	9	9																																																										
	10	10	10																																																										
9	<p>Click Apply to save the new items, and leave the page open.</p>																																																												

Step	Action
10	<p>Repeat steps 2 - 6 for each new word item you need to create. In this example, that includes the following items:</p> <ul style="list-style-type: none">● Rows 2-3, Default Items Name Root: DDI3230_in_st● Rows 4-5: Default Items Name Root: DDO3200_out_echo● Rows 6-7: Default Items Name Root: DDO3200_out_st● Rows 8-9: Default Items Name Root: DDI3420_in_data● Rows 10-11: Default Items Name Root: DDI3420_in_st● Rows 12-13: Default Items Name Root: DDO3410_out_echo● Rows 14-15: Default Items Name Root: DDO3410_out_st● Rows 16-17: Default Items Name Root: DDI3610_in_data● Rows 18-19: Default Items Name Root: DDI3610_in_st● Rows 20-21: Default Items Name Root: DDO3600_out_echo● Rows 22-23: Default Items Name Root: DDO3600_out_st● Rows 24-25: Default Items Name Root: AVI1270_CH1_in_data● Rows 26-27: Default Items Name Root: AVI1270_CH1_in_st● Rows 28-29: Default Items Name Root: AVI1270_CH2_in_data● Rows 30-31: Default Items Name Root: AVI1270_CH2_in_st● Rows 32-33: Default Items Name Root: AVO1250_CH1_out_st● Rows 34-35: Default Items Name Root: AVO1250_CH2_out_st
11	The next task is to create output words.

Creating Output Word Items

To create output items for the STB NIP 2212, example, beginning with an output data word for the DDO 3200 output module:

Step	Action
1	<p>Click on the Output tab to open the following page:</p> <p>NOTE: In this example, each row represents a byte. Because the items you create will be a 16-bit word, each item consists of 2 rows.</p>
2	In the Default Item Name Root input box type: DDO3200_out_data .

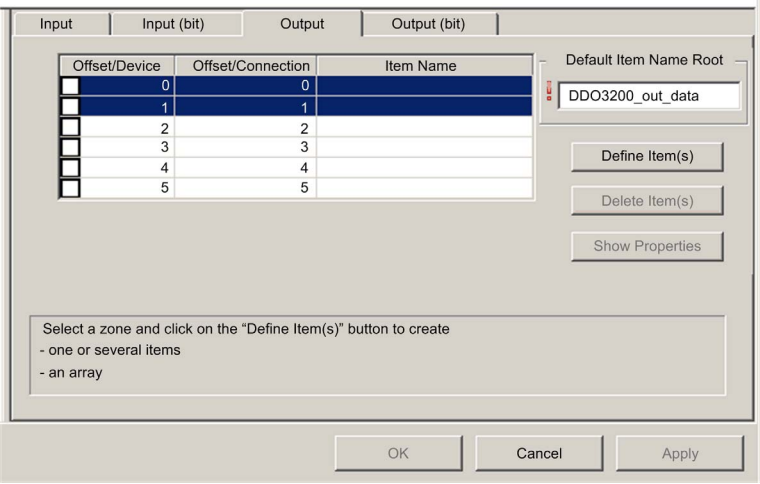
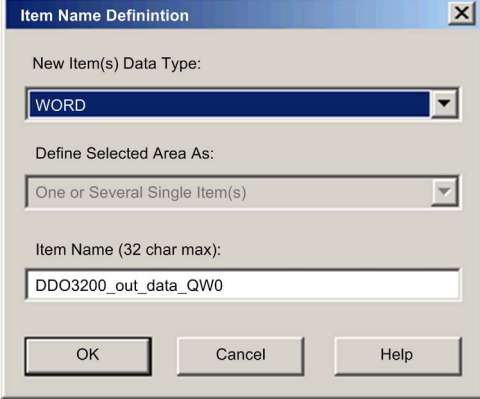
Step	Action
3	<p>Starting at the beginning of the table, select the first 2 rows, 0 and 1:</p> 
4	<p>Click the Define Item(s) button. The Item Name Definition dialog opens:</p>  <p>NOTE: The Define Item(s) button is enabled only when Input Mode is set to Manual.</p>

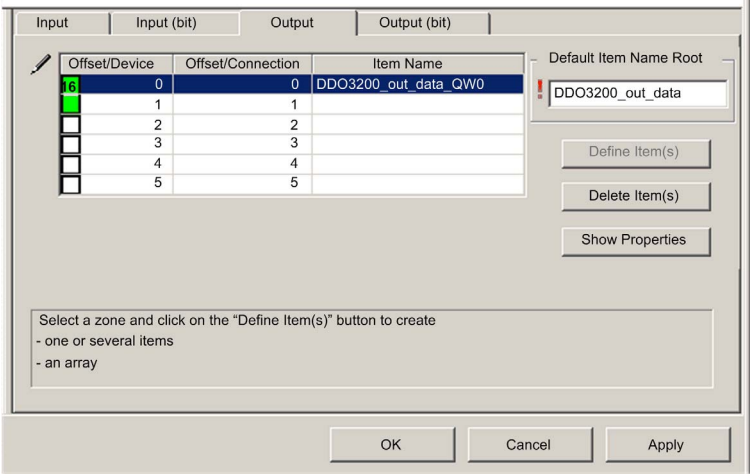
Step	Action
5	<p>Select WORD as the New Item(s) Data Type, then click OK. A new item is created:</p> 
6	Click Apply to save the new item and leave the page open.
7	<p>Repeat steps 2 - 6 for each new word item you need to create. In this example, that includes the following items:</p> <ul style="list-style-type: none"> ● Rows 2-3, Default Items Name Root: DDO3410_out_data ● Rows 4-5, Default Items Name Root: DDO3600_out_data ● Rows 6-7, Default Items Name Root: AVO1250_CH1_out_data ● Rows 8-9, Default Items Name Root: AVO1250_CH2_out_data
8	Click OK to close the Items window.
9	Select File → Save to save your edits.

The next task is to update the Control Expert application (*see Quantum using EcoStruxure™ Control Expert, 140 NOC 771 01 Ethernet Communication Module, User Manual*).

Chapter 4

Working With Derived Data Types

Overview

This chapter describes how to complete your project by creating, updating, and viewing derived data type (DDT) variables in Control Expert.

What Is in This Chapter?

This chapter contains the following topics:

Topic	Page
Creating and Updating Derived Data Types	198
Working with Derived Data Type Variables	200
Effect of Activating and De-activating Devices on I/O %MW Memory Addresses	209

Creating and Updating Derived Data Types

Creating or Updating Derived Data Types

After you have completed your edits in the **Device Editor**, the next step is to let Control Expert create the necessary program objects—in the form of derived data types (DDTs) and variables—that will support your network design. To do this, follow these steps:

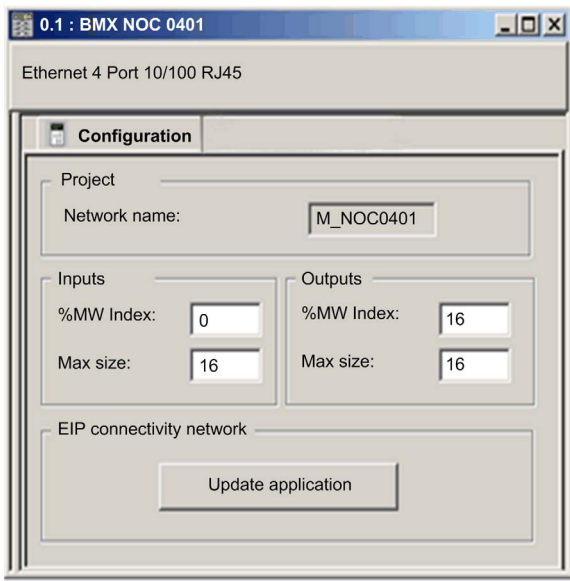
Step	Action
1	In the Project Browser , navigate to and select the communication module.
2	<p>Do one of the following:</p> <ul style="list-style-type: none"> ● click the right mouse button, and select Open in the pop-up menu, or ● in the Edit menu, select Open. <p>The Configuration page of the Ethernet communication module opens, below:</p> 
3	<p>Click the Update application button.</p> <p>NOTE:</p> <ul style="list-style-type: none"> ● Every time you use the Device Editor to make changes to your Control Expert project, return to this screen and click the Update application button to save your edits. ● Control Expert refreshes the collection of DDTs and variables—by adding, editing, or deleting previously generated DDTs and variables—each time you: <ul style="list-style-type: none"> ○ click on the Update application button, above, or ○ select either Build → Build Changes or Build → Rebuild All Project

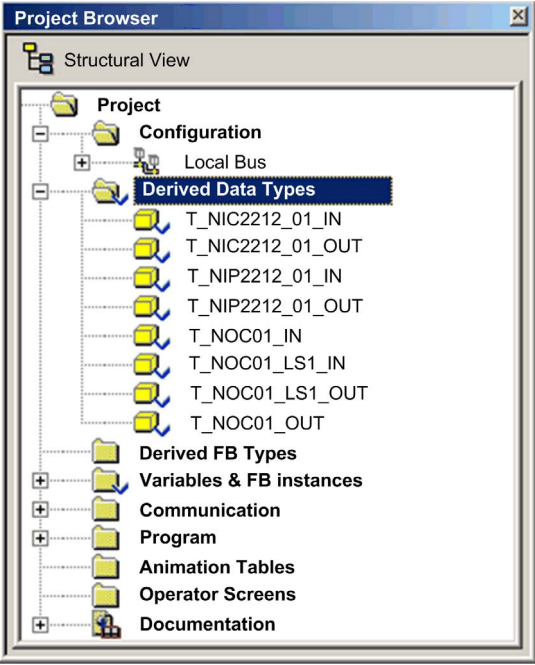
Step	Action
4	<p>Click OK. The Project Browser displays the new or edited derived data types, below:</p>  <p>The screenshot shows the Project Browser window with the following structure:</p> <ul style="list-style-type: none">Project<ul style="list-style-type: none">ConfigurationLocal BusDerived Data Types (highlighted)<ul style="list-style-type: none">T_NIC2212_01_INT_NIC2212_01_OUTT_NIP2212_01_INT_NIP2212_01_OUTT_NOC01_INT_NOC01_LS1_INT_NOC01_LS1_OUTT_NOC01_OUTDerived FB TypesVariables & FB instancesCommunicationProgramAnimation TablesOperator ScreensDocumentation

Working with Derived Data Type Variables

Derived Data Type Variables

When you click on the **Update application** button, Control Expert creates a collection of derived data types and variables. These are used by Control Expert to support communication and data transfer between the PLC and the various local slaves, remote devices, and their I/O items. You can access these derived data types and variables in the Control Expert **Data Editor** and add them to a user-defined **Animation Table**, where you can monitor read-only variables and edit read-write variables.

Use these data types and variables to:

- view the status of connections from the communication module to remote EtherNet/IP and Modbus TCP devices, where:
 - the status of connections is displayed in the form of a HEALTH_BITS array consisting of 32 bytes
 - each connection is represented by a single bit in the array
 - a bit value of 1 indicates the connection is healthy
 - a bit value of 0 indicates the connection is lost, or the communication module can no longer communicate with the remote device
- toggle a connection ON (1) or OFF (0) by writing to a selected bit in a 32 byte CONTROL_BITS array
NOTE: Distinguish between toggling a bit in the CONTROL_BITS array on or off, and enabling or disabling a remote device.
- monitor the value of local slave and remote device input and output items you created in the Control Expert **Device Editor**

Identifying Derived Variables in the Data Editor

To view your Control Expert application's derived data type variables:

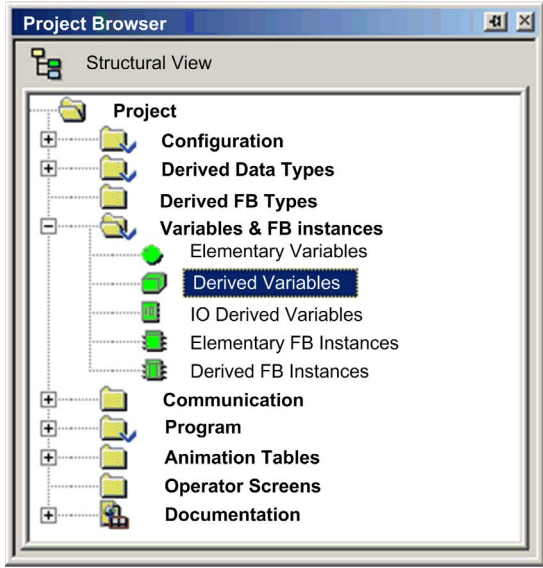
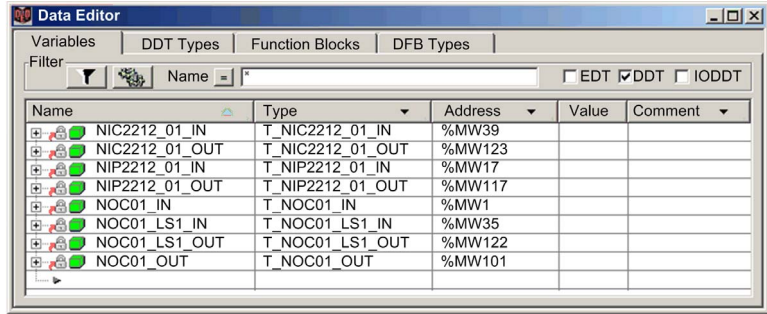
Step	Description																																													
1	<p>In the Project Browser, navigate to and double-click the left mouse button on Variables & FB instances → Derived Variables:</p> 																																													
2	<p>The Data Editor opens, displaying the Variables page:</p>  <table border="1"> <thead> <tr> <th>Name</th> <th>Type</th> <th>Address</th> <th>Value</th> <th>Comment</th> </tr> </thead> <tbody> <tr> <td>NIC2212_01_IN</td> <td>T_NIC2212_01_IN</td> <td>%MW39</td> <td></td> <td></td> </tr> <tr> <td>NIC2212_01_OUT</td> <td>T_NIC2212_01_OUT</td> <td>%MW123</td> <td></td> <td></td> </tr> <tr> <td>NIP2212_01_IN</td> <td>T_NIP2212_01_IN</td> <td>%MW17</td> <td></td> <td></td> </tr> <tr> <td>NIP2212_01_OUT</td> <td>T_NIP2212_01_OUT</td> <td>%MW117</td> <td></td> <td></td> </tr> <tr> <td>NOC01_IN</td> <td>T_NOC01_IN</td> <td>%MW1</td> <td></td> <td></td> </tr> <tr> <td>NOC01_LS1_IN</td> <td>T_NOC01_LS1_IN</td> <td>%MW35</td> <td></td> <td></td> </tr> <tr> <td>NOC01_LS1_OUT</td> <td>T_NOC01_LS1_OUT</td> <td>%MW122</td> <td></td> <td></td> </tr> <tr> <td>NOC01_OUT</td> <td>T_NOC01_OUT</td> <td>%MW101</td> <td></td> <td></td> </tr> </tbody> </table> <p>NOTE:</p> <ul style="list-style-type: none"> • A check mark appears in the DDT checkbox. (If not, select the DDT checkbox to display these variables.) • The red arrow and lock icons indicate the variable name was auto-generated by Control Expert based on the configuration of the local slave or remote device and cannot be edited. 	Name	Type	Address	Value	Comment	NIC2212_01_IN	T_NIC2212_01_IN	%MW39			NIC2212_01_OUT	T_NIC2212_01_OUT	%MW123			NIP2212_01_IN	T_NIP2212_01_IN	%MW17			NIP2212_01_OUT	T_NIP2212_01_OUT	%MW117			NOC01_IN	T_NOC01_IN	%MW1			NOC01_LS1_IN	T_NOC01_LS1_IN	%MW35			NOC01_LS1_OUT	T_NOC01_LS1_OUT	%MW122			NOC01_OUT	T_NOC01_OUT	%MW101		
Name	Type	Address	Value	Comment																																										
NIC2212_01_IN	T_NIC2212_01_IN	%MW39																																												
NIC2212_01_OUT	T_NIC2212_01_OUT	%MW123																																												
NIP2212_01_IN	T_NIP2212_01_IN	%MW17																																												
NIP2212_01_OUT	T_NIP2212_01_OUT	%MW117																																												
NOC01_IN	T_NOC01_IN	%MW1																																												
NOC01_LS1_IN	T_NOC01_LS1_IN	%MW35																																												
NOC01_LS1_OUT	T_NOC01_LS1_OUT	%MW122																																												
NOC01_OUT	T_NOC01_OUT	%MW101																																												

Displaying the Order of Input and Output Items in PLC Memory

The **Data Editor** displays the address of each input and output variable. Click once on the **Address** column header to sort input and output addresses in ascending order. When you open the first input and output variables, you can see both the connection health bits and the connection control bits:

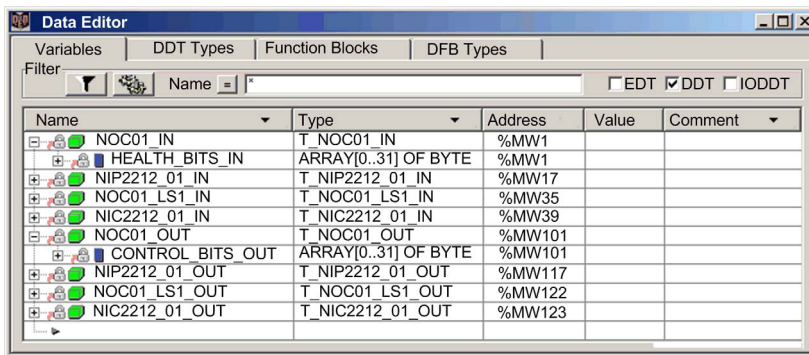

Note the order of inputs and outputs in the above example. Recall that the user defines the size and location of inputs and outputs (*see page 38*). However, within the reserved area for both inputs and outputs, Control Expert assigns addresses to variables in the following order:

Inputs	Order	Outputs
Health bits ¹	1	Control bits ¹
Modbus TCP input variables ²	2	Modbus TCP output variables ²
Local Slave input variables ³	3	Local Slave output variables ³
EtherNet/IP input variables ²	4	EtherNet/IP output variables ²
<ol style="list-style-type: none"> 1. Health and control bits are sub-ordered as follows: <ol style="list-style-type: none"> i. by device type: a. Modbus TCP; b. local slave; c. EtherNet/IP ii. within each device type: <ol style="list-style-type: none"> a. by device or local slave number b. within a device: by connection number 2. Device variables are sub-ordered as follows: <ol style="list-style-type: none"> i. by device number ii. within a device: by connection number iii. within a connection: by item offset 3. Local slave variables are sub-ordered as follows: <ol style="list-style-type: none"> i. by local slave number ii. within each local slave: by item offset 		

NOTE: When a device is added to or removed from the project, or when the active status of an existing device or a local slave changes, the specific location of inputs and outputs in PLC memory also changes.

Identifying the Connection Health Bits

The Ethernet communication module can support up to 128 connections to remote devices. The health of each connection is represented in a single bit value. A health bit value of:

- 1 indicates the connection is active
- 0 indicates the connection is inactive

The health bits are contained in a 32-byte array in the **Variables** page of the **Data Editor**. To display offline this byte array, first sort the variables in ascending order of address, then open the first input variable as shown below:

The screenshot shows the 'Data Editor' window with the 'Variables' tab selected. The table below represents the data shown in the window:

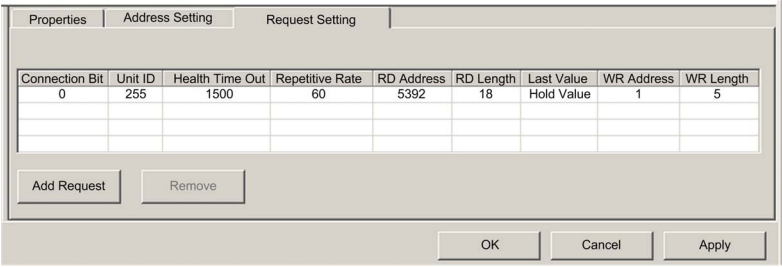
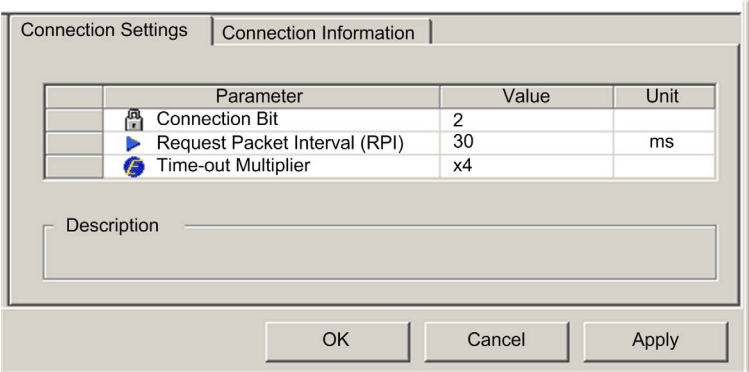

Name	Type	Address	Value	Comment
NOC01_IN	T_NOC01_IN	%MW1		
HEALTH_BITS_IN	ARRAY[0..31]OF BYTE	%MW1		
HEALTH_BITS_IN[0]	BYTE	%MW1		
HEALTH_BITS_IN[1]	BYTE	%MW1		
HEALTH_BITS_IN[2]	BYTE	%MW2		
HEALTH_BITS_IN[3]	BYTE	%MW2		
HEALTH_BITS_IN[4]	BYTE	%MW3		
HEALTH_BITS_IN[5]	BYTE	%MW3		
HEALTH_BITS_IN[6]	BYTE	%MW4		
HEALTH_BITS_IN[7]	BYTE	%MW4		
HEALTH_BITS_IN[7]	BYTE	%MW5		

To determine which health bit is mapped to a specific remote device connection, in the **Device Editor** for the Ethernet communications

Step	Action
1	<p>In the Device Editor for the Ethernet communication module, under the Device List node, navigate to and select:</p> <ul style="list-style-type: none"> • for Modbus TCP devices: the main device node • for EtherNet/IP devices: a connection node
2	<p>For a Modbus TCP device, open the Request Setting page and look for the Connection Bit number:</p>  <p>In the above example (which displays the left portion of a truncated Request Setting page), the Connection Bit value of 0 maps to the first bit in the first byte of the HEALTH_BITS_IN array, which can be represented as <code>HEALTH_BITS_IN[0].0</code>.</p>
3	<p>For an EtherNet/IP device, open the Connection Settings page and look for the Connection Bit number:</p>  <p>In the above example, the Connection Bit value of 2 maps to the third bit in the first byte of the HEALTH_BITS_IN array, which can be represented as <code>HEALTH_BITS_IN[0].2</code>.</p>
4	<p>For a local slave, open the local slave configuration page (<i>see page 113</i>) and look for the Connection Bit number:</p>

Monitoring Connection Health Bits in an Animation Table

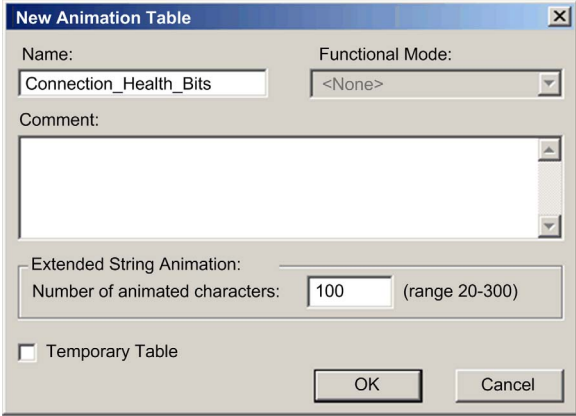
Use an animation table to monitor the status of connection health bits and other variables. To add health bits to an animation table, follow these steps:

Step	Action				
1	In the Project Browser , select the Animation Tables node and click the right mouse button. A pop-up menu opens.				
2	Select New Animation Table .				
3	<p>In the New Animation Table dialog, type in values for the following fields:</p> <table border="1"> <tr> <td>Name</td> <td>Type in a name for the new animation table. In this example, type in Connection_Health_Bits.</td> </tr> <tr> <td>Number of animated characters</td> <td>Accept the default value of 100.</td> </tr> </table> <p>The completed dialog looks like this:</p> 	Name	Type in a name for the new animation table. In this example, type in Connection_Health_Bits .	Number of animated characters	Accept the default value of 100 .
Name	Type in a name for the new animation table. In this example, type in Connection_Health_Bits .				
Number of animated characters	Accept the default value of 100 .				
4	Click OK . The dialog closes and the new Connection_Health_Bits animation table opens.				
5	Double-click on the first empty row in the Name column, then click the ellipsis button  . The Instance Selection dialog opens.				

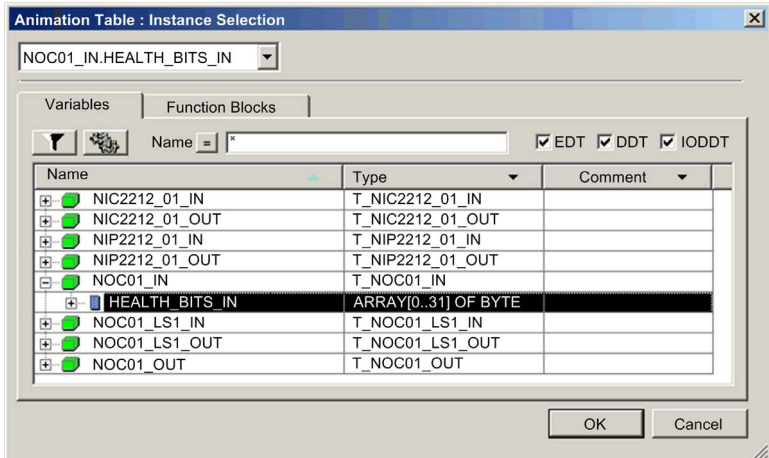
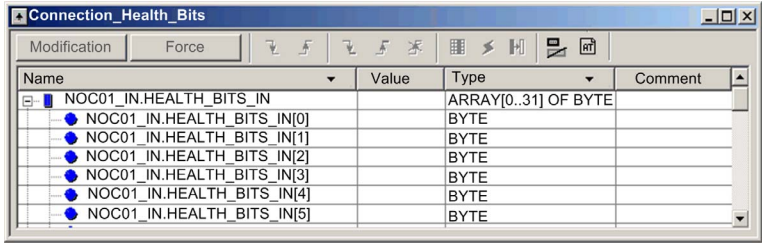
Step	Action																																
6	<p>In the Instance Selection dialog, navigate to and select the entire <code>HEALTH_BITS_IN</code> array:</p>  <p>The screenshot shows the 'Animation Table : Instance Selection' dialog box. The 'Variables' tab is selected, and the 'Name' field is empty. The 'Type' field is 'ARRAY[0..31] OF BYTE'. The 'Comment' field is empty. The 'OK' and 'Cancel' buttons are visible at the bottom right.</p> <table border="1"> <thead> <tr> <th>Name</th> <th>Type</th> <th>Comment</th> </tr> </thead> <tbody> <tr> <td>NIC2212_01_IN</td> <td>T_NIC2212_01_IN</td> <td></td> </tr> <tr> <td>NIC2212_01_OUT</td> <td>T_NIC2212_01_OUT</td> <td></td> </tr> <tr> <td>NIP2212_01_IN</td> <td>T_NIP2212_01_IN</td> <td></td> </tr> <tr> <td>NIP2212_01_OUT</td> <td>T_NIP2212_01_OUT</td> <td></td> </tr> <tr> <td>NOC01_IN</td> <td>T_NOC01_IN</td> <td></td> </tr> <tr> <td>HEALTH_BITS_IN</td> <td>ARRAY[0..31] OF BYTE</td> <td></td> </tr> <tr> <td>NOC01_LS1_IN</td> <td>T_NOC01_LS1_IN</td> <td></td> </tr> <tr> <td>NOC01_LS1_OUT</td> <td>T_NOC01_LS1_OUT</td> <td></td> </tr> <tr> <td>NOC01_OUT</td> <td>T_NOC01_OUT</td> <td></td> </tr> </tbody> </table>	Name	Type	Comment	NIC2212_01_IN	T_NIC2212_01_IN		NIC2212_01_OUT	T_NIC2212_01_OUT		NIP2212_01_IN	T_NIP2212_01_IN		NIP2212_01_OUT	T_NIP2212_01_OUT		NOC01_IN	T_NOC01_IN		HEALTH_BITS_IN	ARRAY[0..31] OF BYTE		NOC01_LS1_IN	T_NOC01_LS1_IN		NOC01_LS1_OUT	T_NOC01_LS1_OUT		NOC01_OUT	T_NOC01_OUT			
Name	Type	Comment																															
NIC2212_01_IN	T_NIC2212_01_IN																																
NIC2212_01_OUT	T_NIC2212_01_OUT																																
NIP2212_01_IN	T_NIP2212_01_IN																																
NIP2212_01_OUT	T_NIP2212_01_OUT																																
NOC01_IN	T_NOC01_IN																																
HEALTH_BITS_IN	ARRAY[0..31] OF BYTE																																
NOC01_LS1_IN	T_NOC01_LS1_IN																																
NOC01_LS1_OUT	T_NOC01_LS1_OUT																																
NOC01_OUT	T_NOC01_OUT																																
7	<p>Click OK to add the array to the Connection_Health_Bits animation table:</p>  <p>The screenshot shows the 'Connection_Health_Bits' animation table. The table has columns for Name, Value, Type, and Comment. The array 'NOC01_IN.HEALTH_BITS_IN' is selected, and its elements are listed below it.</p> <table border="1"> <thead> <tr> <th>Name</th> <th>Value</th> <th>Type</th> <th>Comment</th> </tr> </thead> <tbody> <tr> <td>NOC01_IN.HEALTH_BITS_IN</td> <td></td> <td>ARRAY[0..31] OF BYTE</td> <td></td> </tr> <tr> <td>NOC01_IN.HEALTH_BITS_IN[0]</td> <td></td> <td>BYTE</td> <td></td> </tr> <tr> <td>NOC01_IN.HEALTH_BITS_IN[1]</td> <td></td> <td>BYTE</td> <td></td> </tr> <tr> <td>NOC01_IN.HEALTH_BITS_IN[2]</td> <td></td> <td>BYTE</td> <td></td> </tr> <tr> <td>NOC01_IN.HEALTH_BITS_IN[3]</td> <td></td> <td>BYTE</td> <td></td> </tr> <tr> <td>NOC01_IN.HEALTH_BITS_IN[4]</td> <td></td> <td>BYTE</td> <td></td> </tr> <tr> <td>NOC01_IN.HEALTH_BITS_IN[5]</td> <td></td> <td>BYTE</td> <td></td> </tr> </tbody> </table> <p>Keep in mind that each row represents a byte, which contains eight individual connection health bits. When the DTM for the Ethernet communication module is connected to the physical module, the Value field displays a value for the entire byte.</p>	Name	Value	Type	Comment	NOC01_IN.HEALTH_BITS_IN		ARRAY[0..31] OF BYTE		NOC01_IN.HEALTH_BITS_IN[0]		BYTE		NOC01_IN.HEALTH_BITS_IN[1]		BYTE		NOC01_IN.HEALTH_BITS_IN[2]		BYTE		NOC01_IN.HEALTH_BITS_IN[3]		BYTE		NOC01_IN.HEALTH_BITS_IN[4]		BYTE		NOC01_IN.HEALTH_BITS_IN[5]		BYTE	
Name	Value	Type	Comment																														
NOC01_IN.HEALTH_BITS_IN		ARRAY[0..31] OF BYTE																															
NOC01_IN.HEALTH_BITS_IN[0]		BYTE																															
NOC01_IN.HEALTH_BITS_IN[1]		BYTE																															
NOC01_IN.HEALTH_BITS_IN[2]		BYTE																															
NOC01_IN.HEALTH_BITS_IN[3]		BYTE																															
NOC01_IN.HEALTH_BITS_IN[4]		BYTE																															
NOC01_IN.HEALTH_BITS_IN[5]		BYTE																															

Modifying Connection Control Bits in an Animation Table

You can also use an animation table to modify the value of a control bit, toggling it on or off.

NOTE: Using control bits to toggle a connection on or off (as described below) is the preferred way of regulating communication with a remote device. Toggling a connection control bit on and off does not affect the address location of I/O items. In either case—on or off—the I/O items remain a part of the configuration at the same address locations.

By contrast, enabling and disabling the **Active Configuration** property for a device or local slave either adds I/O items to, or removes I/O items from, the application. This has the rippling effect of changing the addresses not only for the items of the enabled/disabled device, but also for I/O items relating to other devices in the configuration.

The following example shows you how to add connection control bits to the **Connection_Health_Bits** animation table that you created, above, and use the animation table's **Modification** function to toggle control bits on or off:

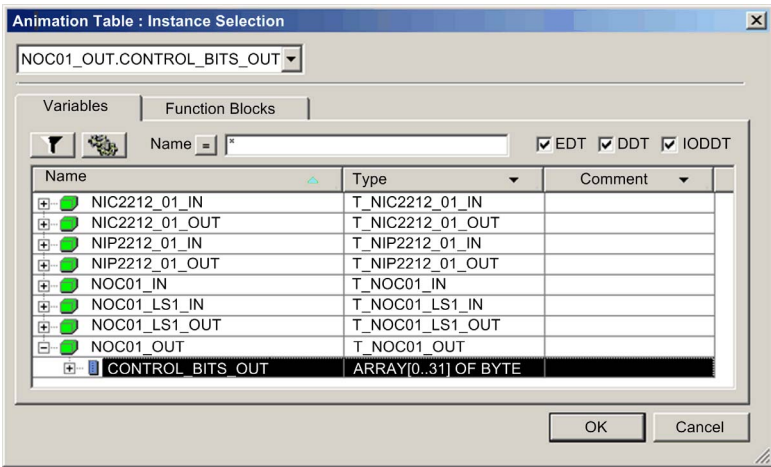
Step	Action
1	With the Connection_Health_Bits animation table open, double-click on the next empty row in the Name column, then click the ellipsis button  . The Instance Selection dialog opens.
2	In the Instance Selection dialog, navigate to and select the entire CONTROL_BITS_OUT array: 

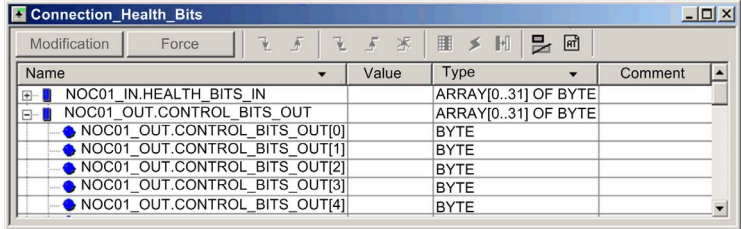
Step	Action
3	<p>Click OK to add the control bit array to the Connection_Health_Bits animation table:</p>  <p>Keep in mind that each row represents a byte, which contains eight individual connection control bits. When the DTM for the Ethernet communication module is connected to the physical module, the Value field displays a value for the entire byte.</p>
4	<p>With the DTM for the Ethernet communication module connected to the physical module, double click in the Value column for the row (byte) that contains the control bit you want to toggle.</p>
5	<p>Type a value that toggles the bit (or bits) in the byte you want to change to on or off. For example, suppose the Value field of the control bit displays an initial value of 7. This indicates that the first three (0, 1, and 2) are not established. If you intend to establish the third connection (connection 2), modify the corresponding bit to 0 (type a value of 3).</p> <p>NOTE: When the control bit is 0, the connection is established. When the control bit is 1, the connection is closed.</p>
6	<p>On your keyboard, press Enter. The control bit for the third connection (i.e. connection number 2) is toggled off.</p>

Effect of Activating and De-activating Devices on I/O %MW Memory Addresses

Introduction

Control Expert assigns a located address in %MW memory to each input and output variable for a remote device and local slave, when that device or slave is activated.

In addition, Control Expert removes from %MW memory each located variable address whenever the related device or slave is de-activated.

In each case, because of the ordered structure of I/O items in PLC memory (*see page 202*), the activation and de-activation of a single device causes a rippling effect on the address locations of other I/O variables throughout the application.

Because activating and de-activating devices can cause substantial changes to located variable addresses, Schneider Electric recommends the following practices:

- Activate every device and local slave your application is likely to use, and allow these devices to remain activated.
- If it subsequently becomes necessary to disable communications to a device or slave, instead of de-activating it, use the appropriate control bits to toggle off all connections to that slave or device (*see page 207*).
- When configuring function blocks in Control Expert, instead of directly reassigning input and output pins to a specific %MW address, do the following: assign specific input and output pins only to the derived data types and variables automatically created by Control Expert.

The Sample Network

The sample network is a part of the same physical network that has been the subject of our continuing configuration example, and includes:

- the Ethernet communication module, named NOC01
- an STB NIC 2212 EtherNet/IP network interface module with I/O modules, named NIC2212_01

Note that, when a new network is created, Control Expert presents three local slave nodes that can be activated and pre-assigns them device numbers 000, 001, and 002. By default, each local slave is not activated. Therefore, each local slave's inputs and outputs are not initially assigned a %MW memory address.

The following example describes the effect of activating a local slave function after another remote device has already been configured and added to the network. In this ca

The sample Ethernet network has been configured as follows:

- Total network inputs and outputs are set in the **Configuration** page of the Ethernet communication module in Control Expert:
 - 100 input words are reserved, beginning at %MW01
 - 100 output words are reserved, beginning at %MW101
- Connection bits for the project include:
 - 32 input bytes (16 words) for health bits with an instance name of NOC01_IN
 - 32 output bytes (16 words) for control bits with an instance name of NOC01_OUT

- Local slave inputs and outputs include:
 - 8 input bytes (4 words) are reserved with an instance name of NOC01_LS1_IN
 - 4 output bytes (2 words) are reserved with an instance name of NOC01_LS1_OUT
- Remote EtherNet/IP device inputs and outputs include:
 - 19 input bytes (10 words) are reserved with an instance name of NIC2212_01_IN
 - 8 output bytes (4 words) are reserved with an instance name of NIC2212_01_OUT

I/O Assignment Without an Activated Local Slave

When you click the **Update application** button in the Ethernet communication module **Configuration** page, with the local slave de-activated, Control Expert auto-generates a collection of variables in support of the application’s I/O items at the following instance locations:

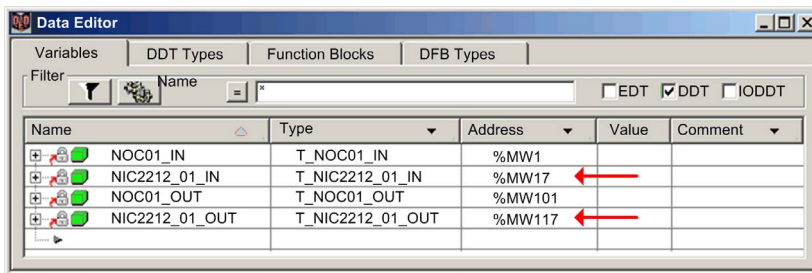

Name	Type	Address	Value	Comment
NOC01_IN	T_NOC01_IN	%MW1		
NIC2212_01_IN	T_NIC2212_01_IN	%MW17		
NOC01_OUT	T_NOC01_OUT	%MW101		
NIC2212_01_OUT	T_NIC2212_01_OUT	%MW117		

Note the address locations of the remote EtherNet/IP device’s inputs (%MW17) and outputs (%MW117). As you will see, below, when the local slave is activated, these address locations will change.

I/O Assignment With an Activated Local Slave

The following example displays input and output variables for the same project. However, in this example the **Active Configuration** setting for the first local slave was set to **Enabled** in the local slave configuration page (see page 115), before the input and output variables were created. As a result clicking the **Update application** button in the Ethernet communication module **Configuration** page generated the following collection of variables:

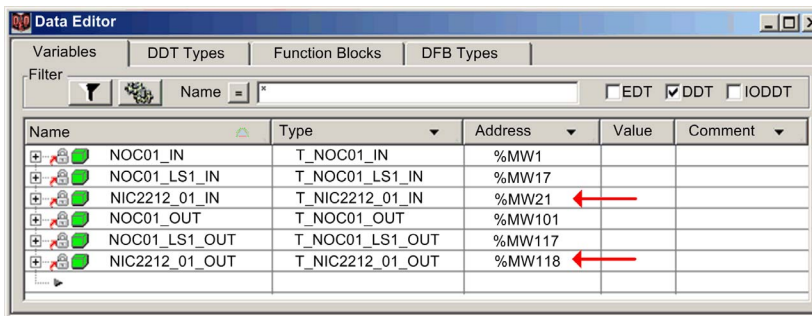

Name	Type	Address	Value	Comment
NOC01_IN	T_NOC01_IN	%MW1		
NOC01_LS1_IN	T_NOC01_LS1_IN	%MW17		
NIC2212_01_IN	T_NIC2212_01_IN	%MW21		
NOC01_OUT	T_NOC01_OUT	%MW101		
NOC01_LS1_OUT	T_NOC01_LS1_OUT	%MW117		
NIC2212_01_OUT	T_NIC2212_01_OUT	%MW118		

Notice how the address locations for the remote EtherNet/IP device have shifted:

- inputs (NIC2212_01_IN) have shifted from %MW17 to %MW21
- outputs (NIC2212_01_OUT) have shifted from %MW117 to %MW118

This shift of %MW input and output memory address assignments occurs because the local slave was activated, and local slave I/O variables are placed in a located memory address position ahead of remote EtherNet/IP device I/O variables.

A similar shift of addresses would occur—with respect to both local slave and EtherNet/IP device I/O variable addresses—if a Modbus TCP remote device is activated. This is because Modbus TCP device I/O variables are placed in a located memory address position ahead of both local slave and EtherNet/IP I/O variables.

As stated above, a way to avoid this shift of I/O memory addresses is to activate every local slave and remote device that your project may require, and then allow them to remain active. To later disable a device, use the appropriate control bits to toggle off every connection to that device.

Chapter 5

Optimizing Performance

Overview

This chapter describes how to optimize the performance of your Ethernet network.

What Is in This Chapter?

This chapter contains the following sections:

Section	Topic	Page
5.1	Selecting a Switch	214
5.2	Control Application Design	224
5.3	Projecting Ethernet Network Performance	238

Section 5.1

Selecting a Switch

Overview

This section describes how to select an Ethernet switch for your network.

What Is in This Section?

This section contains the following topics:

Topic	Page
Role of a Switch in an Ethernet Network	215
Transmission Speed, Duplex and Auto-Negotiation	216
Quality of Service (QoS)	217
IGMP Snooping	218
Rapid Spanning Tree Protocol (RSTP)	219
Virtual Local Area Network (VLAN)	220
Port Mirroring	222
Simple Network Management Protocol (SNMP) Agent	223

Role of a Switch in an Ethernet Network

Overview

Schneider Electric recommends the use of managed switches—not unmanaged switches or hubs—in process control networks. A managed switch provides more functionality than an unmanaged switch, including the ability to:

- turn switch ports on or off
- configure port speed and duplex settings
- control and monitor message traffic within segments
- prioritize message traffic

Recommended Switch Features

When acquiring an Ethernet switch for your process control network, confirm that the switch includes the following features:

- Multiple speed (10/100/1000 Mbps)
- Full duplex
- QoS
- IGMP snooping
- RSTP
- VLAN support
- Port mirroring
- SNMP agent

Transmission Speed, Duplex and Auto-Negotiation

Introduction

Most Ethernet switches support multiple transmission speeds, full- and half-duplex communication, and offer auto-negotiation capability. Hubs, by contrast, are not designed to support full duplex transmissions.

Duplex

Full duplex enables a switch port to both transmit and receive messages simultaneously, over two dedicated communication channels. Half duplex, by contrast, permits a port to transmit or receive messages in only one direction at a time. Signal collisions are possible in half duplex communications—because messages are transmitted and received over a single channel. Half duplex communications can cause poor performance and message loss.

Auto-Negotiation

Auto-negotiation permits a switch port—connected to a remote device that also supports auto-negotiation—to automatically configure itself for the maximum speed and duplex configuration supported by both devices. However, it may be necessary to manually configure the speed and duplex settings of the switch port, if its peer device does not possess auto-negotiation capability.

Recommendation

Schneider Electric recommends that you employ only switches that support:

- both auto-negotiation and manual configuration of speed and duplex settings
- multiple speeds: 10/100/1000 Mbps
- both full duplex and half duplex

Quality of Service (QoS)

Introduction

A switch that supports QoS packet tagging can be configured to deliver higher priority messages before messages with a lower (or no) priority. This enhances system determinism and increases the timely delivery of prioritized messages.

In the absence of QoS tagging, the switch delivers various application messages on a first-in first-out basis. This can result in poor system performance caused by the long forwarding delay—and late delivery—of high priority application messages, which may be handled after lower priority messages.

Types of QoS

The tagging types are based on the switch configuration:

Tagging type	Priority mapping rule	Description
Explicit (QoS tag in Ethernet packet)	DSCP or TOS field in IP header	Each IP based Ethernet packet contains a value in the DSCP or TOS field in its IP header, indicating the QoS priority. The switch forwards packets based on this priority.
	VLAN tag in Ethernet header	Each Ethernet packet contains a value in the priority field in the VLAN tag in its Ethernet header, indicating the QoS priority. The switch forwards packets based on this priority.
Implicit	Port based	Switch ports are mapped to different QoS priorities. For example, switch port 1 is mapped to QoS priority 1, switch port 2 is mapped to QoS priority 2, etc.

Recommendation

Schneider Electric recommends the use of devices—including switches—that support explicit QoS tagging.

NOTE: Some switches that support QoS tagging have this feature disabled by default. Confirm that QoS is enabled when deploying each switch.

IGMP Snooping

Multicast Messaging

Internet Group Management Protocol (IGMP) is an essential feature of multicast messaging. IGMP instructs routers and switches to forward Ethernet multicast packets to only those device ports that have requested these packets.

In the absence of IGMP snooping, a switch forwards multicast packets out of all its ports, resulting in greater network traffic, wasted network bandwidth, and degraded network performance.

Configure one Ethernet network switch as the IGMP querier. This switch periodically polls the field devices connected to the network, which causes all connected devices to issue an *IGMP Multicast Group Join* message. The group message is received by all network switches, which update their multicast addressing information databases in response.

Similarly, when an Ethernet device transmits an *IGMP Multicast Group Leave* message, all network switches update their multicast addressing information databases by removing the device from their databases.

Multicast messaging reduces network traffic by:

- requiring that a message be sent only once
- sending the message only to devices for which the message is intended

Recommendation

Schneider Electric recommend the following:

- employ switches that support IGMP V2 or higher
- because IGMP snooping may be disabled by default, enable IGMP snooping for each network switch
- confirm that one switch is configured as the IGMP querier

Rapid Spanning Tree Protocol (RSTP)

RSTP

Rapid Spanning Tree Protocol (RSTP) is an OSI layer 2 protocol defined by IEEE 802.1D 2004 that performs the following functions:

- it creates a loop-free logical network path for Ethernet devices that are part of a topology that includes redundant physical paths
- it automatically restores network communication—by activating redundant links—in the event the network experiences a broken link

RSTP software, operating simultaneously in every network switch, obtains information from each switch which enables the software to create a hierarchical logical network topology. RSTP is a flexible protocol that can be implemented on many physical topologies, including ring, mesh, or a combination of ring and mesh.

Recommendation

Schneider Electric recommends the following practices:

- Use RSTP instead of STP: RSTP provides a faster recovery time than STP
NOTE: Recovery time is the time that elapses between the moment a broken link is detected to the moment network service is restored. Recovery time depends on:
 - the number of switches in the topology: the more switches, the longer the recovery time
 - the processing speed of the switches in the topology: the slower the speed, the longer the recovery time
 - the bandwidth, traffic load, and topology pattern
- If the switch is part of a topology with redundant physical paths: enable RSTP.
- If the switch is part of a topology that does not include redundant physical paths: disable RSTP—in this case, disabling RSTP improves network performance.

Virtual Local Area Network (VLAN)

Introduction

Use VLANs to divide a larger network into smaller virtual groups of devices, and to split a switch into many virtual network switches. VLANs permit the creation of logically separate groups of network devices, without having to physically re-wire those devices.

When a switch receives a message directed to a specific VLAN, it forwards that message only to the switch ports connected to devices that are members of that VLAN. The switch does not send the message to other ports.

A VLAN reduces network traffic, blocks multicast and broadcast traffic from other VLANs, provides separation between VLANs, and improves system performance.

VLAN Types

Depending upon the switch features, there many different ways to define and implement VLANs:

Tagging type	Mapping rule	Description
Explicit (VLAN tag in Ethernet packet)	Tag based	Each VLAN group is assigned a unique VLAN ID, which is included in each Ethernet packet. The switch forwards packets based on VLAN ID.
Implicit (no VLAN tag in Ethernet packet)	Port based	Switch ports are assigned to different VLANs, when the switch is configured (see example, below.)
	MAC based	A switch maps VLAN group membership—and forwards Ethernet frames—based on device MAC address.
	Protocol based	A switch maps VLAN group membership—and forwards Ethernet frames—based on message protocol.
	IP-subnet based	A switch maps VLAN group membership—and forwards Ethernet frames—based on IP subnet portion of the target address.

Example

In the port-based VLAN example, below, switch ports 1, 2, and 3 are assigned to VLAN A, while switch ports 4, 5, and 6 are assigned to VLAN B:

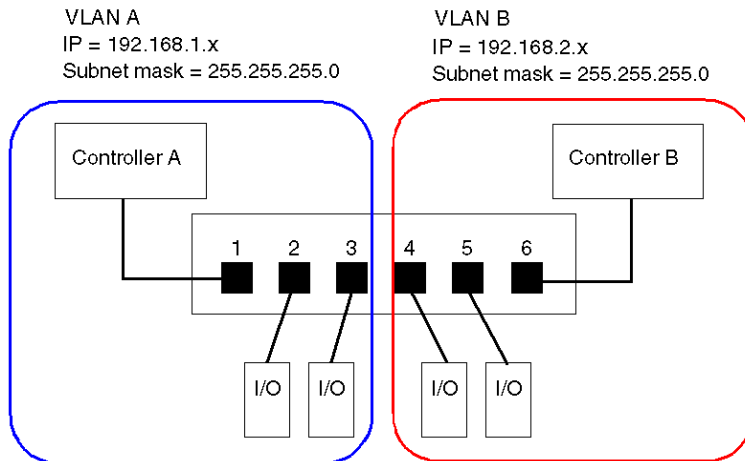

NOTE: A single port can be a member of multiple VLANs.

Port Mirroring

Introduction

Port mirroring lets you troubleshoot switch port transmissions by copying the traffic that passes through one port (the source or mirrored port) and sending the copied transmission to a second port (the destination or mirror) port, where the packets can be examined.

In the following example, the data packets transmitted over port 1 are copied and sent to port 6. To troubleshoot port 1, a PC with packet sniffing software is used to analyze the traffic on port 6 and thereby troubleshoot port 1.

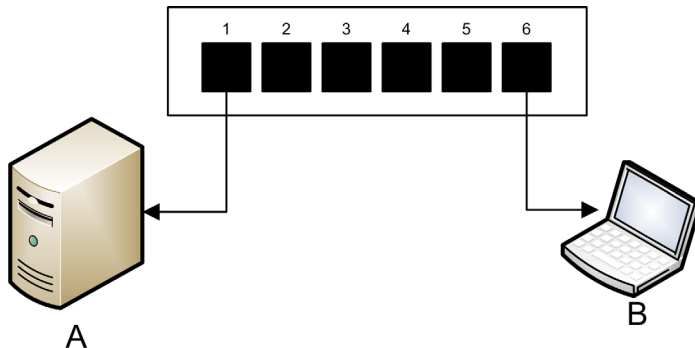

A target device of port 1 transmissions

B PC with packet sniffing software connected to port 6, which mirrors port 1 transmissions

Port mirroring does not affect the normal forwarding behavior of the mirrored port. In many switches, you can configure port mirroring so that you can forward and examine:

- only the incoming packets of a single mirrored port
- only the outgoing packets of a single mirrored port
- both the incoming and outgoing packets of a single mirrored port
- the packets of several mirrored ports—or the whole switch

A packet sniffer's troubleshooting features should include:

- analyzing network performance
- monitoring network activity

Recommendation

Schneider Electric recommends implementing port mirroring as follows:

- Use a destination or mirror port only for port mirroring and not for any other purpose. Connect only the PC with packet sniffer to the mirroring port.
- When configuring the switch, confirm that port mirroring is designed to forward packets—e.g., incoming, outgoing, or both—to meet your requirements.
- A packet sniffer's troubleshooting features should include the capabilities of analyzing network performance and monitoring network activity.

Simple Network Management Protocol (SNMP) Agent

An *SNMP agent* is a software component that responds to queries about the management data of the switch, and reports events to another device acting as an SNMP manager.

The management data for a switch can include:

- operational state information (interface status, mode of operation, etc.)
- configuration parameters (IP address, features enabled / disabled, timer values, etc.)
- performance statistics (frame counters, event logs, etc.)

If a switch is equipped with SNMP agent software, a designated SNMP manager can:

- retrieve management data about the switch
- control the switch by editing its configuration settings
- receive traps—or notices of events—affecting the state of the switch

Section 5.2

Control Application Design

Overview

In a control system, control and automation are achieved by processing and delivering various application service messages.

Understanding messages, allocating network bandwidth among messages, and determining the time required for a message to traverse the network are all major performance considerations of your control application design.

What Is in This Section?

This section contains the following topics:

Topic	Page
Message Types	225
Message Connection Types	227
TCP and CIP Connections	229
Message Priority	230
Messaging Performance	231
Message Frequency	232
Allocating Network Bandwidth	234
Estimating Message Traverse and Response Times	236

Message Types

Overview

Two types of industrial Ethernet message types are supported by the Ethernet communication module:

Message Type	Includes...
Explicit	<ul style="list-style-type: none">● Non-time critical management data● Read/write application data
Implicit	<ul style="list-style-type: none">● Real-time I/O data● Real-time control data● Real-time synchronization data

Explicit Messages

Explicit messages transmit information used for device configuration and diagnostics, and for data collection. In explicit messaging, the client issues a request; the server receives, processes, and sends a response back to the client.

You can specify a response timeout value, indicating how long the client waits for a response from the server. If the client does not receive a response from the server within the response timeout period, the client reissues its request. The length of the response timeout will vary depending on the requirements of your application.

Examples of explicit messages include: SNMP messages, FTP messages, CIP establish connection messages, EtherNet/IP query and response messages, and DHCP messages.

The characteristics of explicit messaging are:

- point-to-point client-server mode
- variable size
- variable frequency
- long response time
- long connection timeout

Explicit messages can be sent as either connected or unconnected, depending on the frequency of your need for data, and on the level of service required:

Message type	Characteristics
Connected	<ul style="list-style-type: none"> ● Begins when an originating device initiates a connection by sending a request to a target device. ● The connection is established when the originator receives a successful response from the target. ● A CIP connected message has a higher priority and provides better service, but requires a greater amount of resources from both the target and originator devices. ● Used for recurring requests, and for high priority parameter monitoring. ● Typically use short response timeout settings.
Unconnected	<ul style="list-style-type: none"> ● Less resource intensive. ● Used for less frequent requests, and for lower priority parameter monitoring. ● Typically use very long response timeout settings.

NOTE: The response timeout can be configured using the **EM Request Timeout** parameter (located in the **Channel Properties** → **EtherNet/IP** page).

Implicit Messages

Implicit messages consist of packets of data that are time critical. Implicit messages are used for real-time control and synchronization. Examples of implicit messages include: real-time I/O data, motion control data, functional diagnostic data, real-time synchronization data, and network topology management data.

Implicit messages require determinism and high performance in message processing and delivery.

The characteristics of implicit messaging are:

- producer/consumer mode (EtherNet/IP) or client/server mode (Modbus TCP)
- small, fixed data size
- fixed frequency
- short response time
- short connection timeout

Message Connection Types

Introduction

The transmission of most messages require a point-to-point connection between a transmitter and receiver.

For all types of explicit messages, the connection automatically closes when the communication ends, or is timed-out.

For implicit messages, keep the connection open. If the I/O connection—CIP for EtherNet/IP, TCP for Modbus TCP—the transmission stops. In this case, the scanner employs the TCP implicit messaging connection to dynamically re-establish the CIP connection.

Calculating the Connection Timeout

For CIP connections, you can control the connection timeout setting by specifying both the network multiplier and the requested packet interval (RPI in ms):

$$\text{Timeout} = \text{Network Multiplier} \times \text{RPI}$$

NOTE: You can locate and configure these values in the Control Expert Ethernet Configuration Tool. Open the **DTM Editor** for the Ethernet communication module, then edit the following settings:

- the network multiple is the **Time-out Multiplier** parameter found in the **Device List** → **<device>** → **<connection>** → **Connection Settings** page, and
- the RPI is the **EM Connection RPI** parameter found in the **Channel Properties** → **EtherNet/IP** page

A large timeout value may affect the ability of the network to optimize the availability of connection resources, re-establish connections, and update I/O data when the connection is lost.

A small timeout value may unnecessarily cause the frequent closing and re-establishing of connections.

It is preferable to use a larger timeout value for explicit messaging connections, and a smaller timeout value for implicit messaging connections. The specific value you employ depends on your application requirements.

Connection Types and Protocols

The connection type and transport protocol employed depends upon the message type and message protocol, as follows:

Message Type	Message Protocol	Connection Type	Connection Protocol
Explicit	EtherNet/IP	CIP, TCP	TCP/IP
	Modbus TCP	TCP	TCP/IP
	FTP	TCP	TCP/IP
	HTML (web)	TCP	TCP/IP
	SMTP	TCP	TCP/IP
	SNMP	N/A	UDP/IP
	SNTP	N/A	UDP/IP
	DHCP	N/A	UDP/IP
	BOOTP	N/A	UDP/IP
Implicit	EtherNet/IP	CIP, TCP	UDP/IP
	Modbus TCP	TCP	TCP/IP
	IGMP	N/A	IP
	RSTP	N/A	Ethernet

Connection- Overhead

Any message transmission includes overhead, which consumes network bandwidth and processing time. The smaller the size of the data transmitted, the relatively greater the portion of the message allocated to overhead.

Consequently, it makes sense to design your I/O messaging by consolidating data from multiple I/O devices—with similar processing capabilities and performance needs—and transmitting it through a single adapter. This design conserves bandwidth, stores network resources, and improves performance.

TCP and CIP Connections

Number of Connections Supported

The Ethernet communication module employs both TCP and CIP connections to support both implicit and explicit messages, as follows:

Connection Type	Maximum Number of Connections per Module
CIP	256
TCP	128

NOTE:

- A single TCP connection can support multiple CIP connections.
- The maximum number of TCP connections does not include connections dedicated to other services, for example, FTP and Web connections.

Message Priority

QoS

The routers and switches that comprise your network infrastructure cannot distinguish between explicit message and implicit messages. However, these devices—including the Ethernet communication module—can support QoS Ethernet packet tagging (*see Quantum using EcoStruxure™ Control Expert, 140 NOC 771 01 Ethernet Communication Module, User Manual*).

Using QoS tagging, these devices can handle messages they send and receive according to each message's tagged priority, forwarding higher priority messages before lower priority messages.

Messaging Performance

Maximum Messaging Load

The Ethernet communication module supports the following maximum messaging loads:

Message Type	Maximum Messaging Load
Implicit (EtherNet/IP plus Modbus TCP)	12000 packets per second, with no simultaneous explicit messages
Explicit (EtherNet/IP plus Modbus TCP)	120 packets per second, with a maximum of 6000 simultaneous implicit messages

Message Frequency

Introduction

The term *message frequency* refers to how often a device transmits a particular type of message. Message frequency directly affects control network load and performance, as well as the CPU capacity of every network device that processes these messages.

Depending on your application requirements, real-time I/O data can be transmitted using implicit messaging as follows:

- on a cyclic basis, at the *request packet interval* (RPI) rate, or
- upon the occurrence of a change of state event

Cyclic Real-Time I/O Messaging

Much of the load on an Ethernet control network consists of cyclic real-time I/O data. Consequently, carefully consider how to set the RPI value for transmitting these messages:

- A small RPI value results in more frequent, and more numerous, message transmissions. This increases network load, and may waste network resources and degrade system performance.
- Conversely, a larger RPI value—for example, one that is equal (or nearly equal) to the frequency of your application's need for new data—can result in your application not receiving the most current data. Also, if a connection is lost, the time to re-establish the connection will be relatively long, because the connection timeout is proportional to the RPI.

Schneider Electric recommends setting RPI to 50% of the actual frequency by which your application requires data for cyclic real-time I/O messaging.

NOTE: The I/O scanner can simultaneously communicate with different I/O adapters at different RPI rates. This enhances the ability of the PLC to control and monitor different devices with varying processing capacities.

Change of State I/O Messaging

For change of state triggered real-time I/O data messages:

- output transmissions occur at the rate of the PLC controller application cycle time
- input transmissions occur whenever an input event is detected by an input device

Consequently, for an I/O device with a rapid response and transmission time, using a direct connection to the I/O device may be more efficient than using a rack optimized connection. In this design, because only the single device input data is sent, the size of the frequently transmitted message is potentially much smaller than would be the case if the message contained data from every I/O device on the remote island.

NOTE: A change of state (versus cyclic) triggered real-time I/O message usually reduces network load. Configure the change of state message with a longer connection timeout value.

RSTP and IGMP Messaging

RSTP and IGMP messages usually consume a very small amount of network bandwidth. Set up the IGMP query period based on your application requirements.

Scheduling Certain Explicit Messages

Depending on your application requirements, you can also configure certain explicit messages to be transmitted either cyclically or upon the occurrence of a change of state event. For example, you can periodically monitor a device using SNMP query, Web pages, EtherNet/IP, and Modbus TCP. The cyclic period should be configured so that the total load consumed by explicit messaging does not exceed 10% of network capacity.

Allocating Network Bandwidth

Introduction

Maximum network bandwidth equals your network speed, for example 100 Mbps. When designing your control network, allocate network bandwidth among the control application messages required by your application.

NOTE: Schneider Electric recommends you reserve at least the following amounts for processing explicit messaging:

- 10% of network bandwidth
- 10% of CPU processing capacity for each network device

Message Load and Message Bandwidth

Message Load—in packets per second (PPS)—represents the number of packets in a single message that are received and sent within one second. *Message Load* can be estimated as follows:

Message Load =

$$(\text{number of packets per connection}) \times (\text{number of connections}) / \text{RPI}$$

The *number of packets per connection* value depends on the capacity of the device, and can be either:

- 1: for connections that support uni-directional communication
- 2: for connections that support input and output (for producer/consumer mode) or request and response (for client/server mode) per one time bi-directional exchange, or

The connection can be used for either explicit or implicit messaging. For UDP-based explicit messaging, assume that each client represents one connection, and that messages are transmitted cyclically.

Message Bandwidth (in bits) can be calculated as follows:

Message Bandwidth = message packet size (bits) x Message Load

Based on the portion of network bandwidth you want to allocate to a particular message, you can use the *Message Load* and *Message Bandwidth* formulae to calculate the fastest RPI for the message.

Device Load and Device Bandwidth

Device Load—measured in number of packets—represents the load contributed by messages received and sent by a device within one second. *Device Load* is the sum of the *Message Load* values for every message handled by the device.

If the *Device Load* exceeds the device's processing capability, performance of both the device and the network is degraded.

NOTE: Schneider Electric recommends that *Device Load* not exceed 90% of CPU processing capacity of each device.

Device Bandwidth—measured in bits—is the sum of the *Message Bandwidth* values for messages handled by the device

In your control application design, determine whether the I/O scanner device can handle the load contributed by every I/O adapter device. To do this, perform the following steps:

- 1 Calculate the implicit messaging load and bandwidth for each remote device.
- 2 Sum the load and bandwidth estimates for every remote device.
- 3 Compare the total implicit messaging load and bandwidth against the maximum implicit messaging capacity of the device acting as I/O scanner.

If the projected total load or bandwidth for a communication module acting as an I/O scanner exceeds its implicit messaging load or bandwidth limits, consider one or more of the following corrective actions:

- If the I/O adapter supports rack optimized connections, and if a single rack of digital I/O uses multiple direct connections, replace the direct connections with a single rack optimized connection, if possible.
- Increase the RPI setting for a device where possible.
- Add another communication module to act as an I/O scanner, and re-design the network in order to share the load.

Network Load and Network Bandwidth

Network Load—measured in number of packets—can be estimated as the sum of the *Device Load* of the adapter devices, or of the scanner devices.

Network Bandwidth—measured in bits—can be estimated as the sum of the *Device Bandwidth* of the adapter devices, or of the scanner devices.

NOTE: Schneider Electric recommends that *Network Load* not exceed 90% of maximum network bandwidth.

If necessary, you may need to optimize your control application design by:

- adjusting device RPI settings
- changing connection types (e.g., from direct to rack optimized)
- modify the configuration
- change the network topology

Estimating Message Traverse and Response Times

Message Traverse Time

Message Traverse Time is defined as the time required for a message to travel from its point of origin to its targeted destination over a network path. As the messages travels over the network path, it may pass through—and be forwarded by—a number of intermediate network devices, including switches and routers.

Message Traverse Time is impacted by several factors, including, for example, the following:

- the number of forwarding network devices
- the transmission delay of each forwarding device
- network load
- message priority

Message Traverse Time can be estimated by determining the transmission delay (the store and forward delay) of intermediate network devices and counting the number of such devices. Assuming each forwarding device is a switch, and each switch presents the same transmission delay, the following formula can be used:

Message Traverse Time =
(Switch Transmission Delay) x (Number of Switches)

Schneider Electric recommends that you estimate a worst-case *Message Traverse Time*, as follows:

Step	Description
1	Determine the worst case network load.
2	Obtain switch performance information, under varying network loads, and use the worst case—i.e., the largest—transmission delay value.
3	Determine the logical network topology that yields the longest path—i.e. the greatest number of switches—through which a message passes.
4	Using the largest transmission delay value and the largest number of forwarding switches, use the formula (above) to calculate a worst-cast <i>Message Traverse Time</i> .

Message Response Time

After calculating *Message Traverse Time* (above), you can next measure *Message Response Time*, which measures the total time required for:

- a message to travel from a client device over the network to a server
- the message to be processed by the server
- the server response to travel back to the client over the network

Message Response Time can be calculated as follows:

Message Response Time =

$$(2 \times (\text{Message Traverse Time})) + (\text{Server Processing Time})$$

In the above formula, '2' indicates a round trip required for client/server communication.

After *Message Response Time* is calculated, you can determine and configure the following parameters, both of which are found in the **Channel Properties** → **EtherNet/IP** page of the Control Expert Ethernet Configuration Tool:

- **EM Request Timeout** value, and
- **EM Connection RPI**

Section 5.3

Projecting Ethernet Network Performance

Network Load and Bandwidth Calculation Example

Network Devices

This example estimates the performance for an Ethernet network composed of the following devices:

- a PLC that controls 3 remote I/O stations (A, B, and C)
- BMX NOC 0401 Ethernet communication module, acting as the local I/O scanner, installed in the PLC rack
- an 8-port Ethernet managed switch
- a PC running used to obtain diagnostic data via explicit messages running the following software:
 - Control Expert
 - the Control Expert Ethernet Configuration Tool
- 4 remote devices, acting as:
 - an I/O adapter (A) for a rack of I/O modules
 - a second I/O adapter (B) for a rack of I/O modules
 - a remote I/O drive (C)
 - a remote I/O scanner (D)

Control Expert software running in the PC is used to configure the CPU controller.

For programming purposes you need a connection to the PLC either through the CPU's Ethernet port or other supported programming paths.

Network Diagram

The proposed network diagram looks like this:

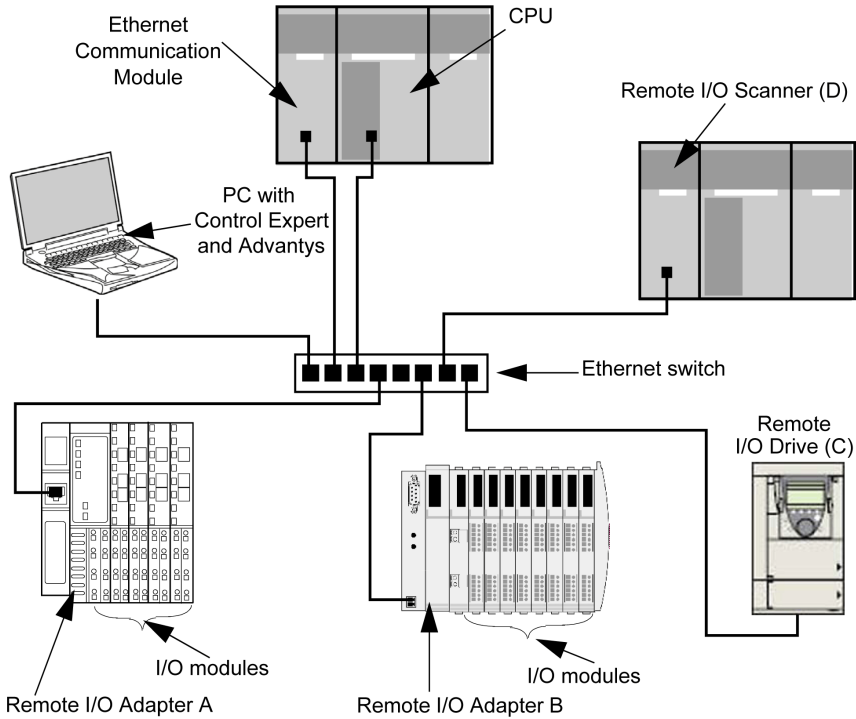

Network Load and Bandwidth Limits

When performing calculations, keep in mind that the Ethernet module and remote devices cannot exceed their implicit messaging and bandwidth limits:

Device	Load Limits	Bandwidth Limits
Ethernet Communication Module	12000 pps	80 Mbps
I/O Adapter (A)	8000 pps	70 Mbps
I/O Adapter (B)	8000 pps	70 Mbps
I/O Drive (C)	8000 pps	70 Mbps
I/O Scanner (D)	12000 pps	80 Mbps
Switch	16000 pps	90 Mbps

Remote Device Connections and RPI

For the purpose of this example, it is assumed that the remote devices require the following numbers of CIP connections, and are configured for the stated requested packet interval (RPI) settings:

Device	CIP I/O Connections	RPI Setting	I/O Packet Size
I/O Adapter (A)	5	20 ms	8000 bits
I/O Adapter (B)	2	30 ms	4096 bits
I/O Drive (C)	2	30 ms	8000 bits
I/O Scanner (D)	2	50 ms	8000 bits

For the purposes of this example, it is also assumed that every connection is bi-directional.

I/O Scanner Calculations

The Ethernet communication module, acting as local I/O scanner, has to handle the implicit messaging load contributed by the remote devices. Your task is to:

- 1 estimate the implicit messaging load and bandwidth contributed by each remote device
- 2 sum the load and bandwidth values for each remote device
- 3 compare the total load and bandwidth against the maximum implicit messaging capacity of the local I/O scanner

Recall that the implicit messaging load calculation formula for a single remote device is:

$$\text{Load} = (\text{number of packets per connection}) \times (\text{number of connections}) / \text{RPI}$$

Because every connection is assumed to be bi-directional, the *number of packets per connection* value is 2. Consequently, the estimated implicit messaging load contributed by each device, and the total implicit messaging load the local I/O scanner has to handle can be estimated as follows:

Load:

Device	Number of packets per connection	X	Number of connections	+	RPI	=	Load
I/O Adapter (A)	2	X	5	+	20 ms	=	500 pps
I/O Adapter (B)	2	X	2	+	30 ms	=	134 pps
I/O Drive (C)	2	X	2	+	30 ms	=	134 pps
I/O Scanner (D)	2	X	2	+	50 ms	=	80 pps
Total						=	848 pps
Switch						=	848 pps

Bandwidth:

Device	Packet size	X	Load	=	Bandwidth
I/O Adapter (A)	8000 bits	X	500 pps	=	4 Mbps
I/O Adapter (B)	4096 bits	X	134 pps	=	0.554 Mbps
I/O Drive (C)	8000 bits	X	134 pps	=	1.07 Mbps
I/O Scanner (D)	8000 bits	X	80 pps	=	0.64 Mbps
Total				=	6.26 Mbps
Switch				=	6.26 Mbps

Conclusion

The projected total load for the module—848 pps—is within the device implicit messaging limit of 12000 data packets per second. The projected total bandwidth for the communication module—6.26 Mbps—is also within the device implicit messaging bandwidth limit of 80 Mbps. The projected total load and bandwidth for the remote devices (including the switch) are also within their 90% load and bandwidth limits:

Device	90% of Load Limit	90% of Bandwidth Limit
Ethernet Communication Module	10800 pps	72 Mbps
I/O Adapter (A)	7200 pps	63 Mbps
I/O Adapter (B)	7200 pps	63 Mbps
I/O Drive (C)	7200 pps	63 Mbps
I/O Scanner (D)	10800 pps	72 Mbps

NOTE: Although message load contributed by explicit messaging are not included in the above calculations, such load contributions are presumed to be less than 10% of the device load and bandwidth.

Chapter 6

CIP Objects

Overview

The Ethernet communication module can access CIP data and services located in connected devices. The CIP objects and their content depends on the design of each device.

CIP object data and content are exposed—and accessed—hierarchically in the following nested levels:

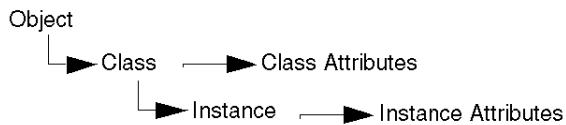

NOTE: You can use explicit messaging to access either:

- a collection of instance attributes, by including in the explicit message address only the object's class and instance values, or
- a single attribute, by extending the explicit message address to include not only the object's class and instance values but also a specific attribute value

When the Ethernet communication module's local slave service is activated, remote devices can send explicit messages to the module's CIP object structure and:

- access module data, or
- execute module commands

This chapter describes the CIP objects the Ethernet communication module exposes to remote devices.

What Is in This Chapter?

This chapter contains the following topics:

Topic	Page
Identity Object	245
Assembly Object	247
Connection Manager Object	249
Modbus Object	251
Quality Of Service (QoS) Object	253
TCP/IP Interface Object	255
Ethernet Link Object	257
EtherNet/IP Interface Diagnostics Object	262
EtherNet/IP IO Scanner Diagnostics Object	265
IO Connection Diagnostics Object	267
EtherNet/IP Explicit Connection Diagnostics Object	271
EtherNet/IP Explicit Connection Diagnostics List Object	273

Identity Object

Overview

The Identity object presents the instances, attributes and services described below.

Class ID

01

Instance IDs

The Identity object presents two instances:

- 0: class
- 1: instance

Attributes

Identity object attributes are associated with each instance, as follows:

Instance ID = 0 (class attributes):

Attribute ID	Description	GET	SET
01	Revision	X	—
02	Max Instance	X	—
X = supported — = not supported			

Instance ID = 1 (instance attributes):

Attribute ID		Description	Type	GET	SET
hex	dec				
01	01	Vendor ID	UINT	X	—
02	02	Device Type	UINT	X	—
03	03	Product Code	UINT	X	—
04	04	Revision	STRUCT	X	—
		Major	USINT		
		Minor	USINT		
X = supported — = not supported					

Attribute ID		Description	Type	GET	SET
hex	dec				
05	05	Status bit 2: 0x01=the module is configured bits 4-7: 0x03=no I/O connections established 0x06=at least 1 I/O connection in run mode 0x07=at least 1 I/O connection established, all in IDLE mode	Word	X	—
06	06	Serial Number	UDINT	X	—
07	07	Product Name	STRING	X	—
18	24	Modbus Identity	STRUCT	X	—
X = supported — = not supported					

Services

The Identity object performs the following services upon the listed object types:

Service ID		Description	Class	Instance	Notes
hex	dec				
01	01	Get_Attributes_All	X	X	Returns: <ul style="list-style-type: none"> all class attributes (instance = 0) instance attributes 1 to 7 (instance = 1)
0E	14	Get_Attribute_Single	X	X	Returns the value of the specified attribute.
X = supported — = not supported					

Assembly Object

Overview

The Assembly object consists of the attributes and services described below.

NOTE: You can send an explicit message to the Assembly object only when no other connections have been established that read from or write to this object. For example, you can send an explicit message to the Assembly object if a local slave instance is enabled, but no other module is scanning that local slave.

Class ID

04

Instance IDs

The Assembly object presents the following instance identifiers:

- 0: class
- 101, 102, 111, 112, 121, 122: instance

Attributes

The Assembly object consists of the following attributes:

Instance ID = 0 (class attributes):

Attribute ID	Description	GET	SET
01	Revision	X	—
02	Max Instance	X	—
03	Number of Instances	X	—
X = supported — = not supported			

Instance attributes:

Instance ID	Attribute ID	Description	Type	GET	SET
101	03	Local slave 1: T->O input data	Array of BYTE	X	—
102		Local slave 1: O>T	Array of BYTE	X	X
111		Local slave 2: T->O input data	Array of BYTE	X	—
112		Local slave 2: O>T	Array of BYTE	X	X
121		Local slave 3: T->O input data	Array of BYTE	X	—
122		Local slave 3: O>T	Array of BYTE	X	X
X = supported — = not supported					

Services

The CIP Assembly object performs these services upon the listed object types:

Service ID		Description	Class	Instance	Notes
hex	dec				
0E	14	Get_Attribute_Single	X	X	Returns the value of the specified attribute
10	16	Set_Attribute_Single ¹	—	X	Returns these values: 0E=attribute not settable: assembly is not o->T type 0F=permission denied: assembly is being used by an active connection 13=config too small: the Set_Attribute_Single command contains partial data 15=data too big: the Set_Attribute_Single command contains too much data
X = supported — = not supported					
1. When valid, the size of the data written to the Assembly object using the Set_Attribute_Single service equals the size of the Assembly object as configured in the target module.					

Connection Manager Object

Overview

The Connection Manager object presents the instances, attributes and services described below.

Class ID

06

Instance IDs

The Connection Manager object presents two instance values:

- 0: class
- 1: instance

Attributes

Connection Manager object attributes are associated with each instance, as follows:

Instance ID = 0 (class attributes):

Attribute ID	Description	GET	SET
01	Revision	X	—
02	Max Instance	X	—
X = supported — = not supported			

Instance ID = 1 (instance attributes):

Attribute ID		Description	Type	GET	SET	Value
hex	dec					
01	01	Open Requests	UINT	X	X	Number of Forward Open service requests received
02	02	Open Format Rejects	UINT	X	X	Number of Forward Open service requests that were rejected due to bad format
03	03	Open Resource Rejects	UINT	X	X	Number of Forward Open service requests that were rejected due to lack of resources
X = supported — = not supported						

Attribute ID		Description	Type	GET	SET	Value
hex	dec					
04	04	Open Other Rejects	UINT	X	X	Number of Forward Open service requests that were rejected for reasons other than bad format or lack of resources
05	05	Close Requests	UINT	X	X	Number of Forward Close service requests received
06	06	Close Format Requests	UINT	X	X	Number of Forward Close service requests that were rejected due to bad format
07	07	Close Other Requests	UINT	X	X	Number of Forward Close service requests that were rejected for reasons other than bad format
08	08	Connection Timeouts	UINT	X	X	Total number of connection timeouts that occurred in connections controlled by this connections manager
09	09	Connection Entry List	STRUCT	X	—	0 (Unsupported optional item)
0B	11	CPU_Utilization	UINT	X	—	0 (Unsupported optional item)
0C	12	MaxBuffSize	UDINT	X	—	0 (Unsupported optional item)
0D	13	BufSize Remaining	UDINT	X	—	0 (Unsupported optional item)
X = supported — = not supported						

Services

The Connection Manager object performs the following services on the listed object types:

Service ID		Description	Class	Instance	Notes
hex	dec				
01	01	Get_Attributes_All	X	X	Returns the value of all attributes.
0E	14	Get_Attribute_Single	X	X	Returns the value of the specified attribute.
X = supported — = not supported					

Modbus Object

Overview

The Modbus object converts EtherNet/IP service requests to Modbus functions, and Modbus exception codes to CIP General Status codes. It presents the instances, attributes and services described below.

Class ID

44 (hex), 68 (decimal)

Instance IDs

The Modbus object presents two instance values:

- 0: class
- 1: instance

Attributes

The Modbus object consists of the following attributes:

Instance ID = 0 (class attributes):

Attribute ID	Description	GET	SET
01	Revision	X	—
02	Max Instance	X	—
X = supported — = not supported			

Instance ID = 1 (instance attributes):

Attribute ID	Description	Type	GET	SET
—	No instance attributes are supported	—	—	—

Services

The Modbus object performs the following services upon the listed object types:

Service ID		Description	Class	Instance
hex	dec			
0E	14	Get_Attribute_Single	X	X
4B	75	Read_Discrete_Inputs	—	X
4C	76	Read_Coils	—	X
4D	77	Read_Input_Registers	—	X
4E	78	Read_Holding_Registers	—	X
4F	79	Write_Coils	—	X
50	80	Write_Holding_Registers	—	X
51	81	Modbus_Passthrough	—	X
X = supported — = not supported				

Quality Of Service (QoS) Object

Overview

The QoS object implements Differentiated Services Code Point (DSCP or *DiffServe*) values for the purpose of providing a method of prioritizing Ethernet messages. The QoS object presents the instances, attributes and services described below.

Class ID

48 (hex), 72 (decimal)

Instance IDs

The QoS object presents two instance values:

- 0: class
- 1: instance

Attributes

The QoS object consists of the following attributes:

Instance ID = 0 (class attributes):

Attribute ID	Description	GET	SET
01	Revision	X	—
02	Max Instance	X	—
X = supported — = not supported			

Instance ID = 1 (instance attributes):

Attribute ID	Description	Type	GET	SET	Value
04	DSCP Urgent	USINT	X	X	For CIP transport class 0/1 Urgent priority messages, default value = 55.
05	DSCP Scheduled	USINT	X	X	For CIP transport class 0/1 Urgent priority messages, default value = 47.
06	DSCP High	USINT	X	X	For CIP transport class 0/1 Urgent priority messages, default value = 43.
07	DSCP Low	USINT	X	X	For CIP transport class 0/1 Urgent priority messages, default value = 31.
08	DSCP Explicit	USINT	X	X	For CIP explicit messages (transport class 2/3 and UCMM), default value = 27.
X = supported — = not supported					

NOTE: A change in the instance attribute value takes effect on device re-start, for configurations made from flash memory.

Services

The QoS object performs the following services upon the listed object types:

Service ID		Description	Class	Instance
hex	dec			
0E	14	Get_Attribute_Single	X	X
10	16	Set_Attribute_Single	—	X
X = supported — = not supported				

TCP/IP Interface Object

Overview

The TCP/IP interface object presents the instances (per network), attributes and services described below.

Class ID

F5 (hex), 245 (decimal)

Instance IDs

The TCP/IP interface object presents 2 instance values:

- 0: class
- 1: instance

Attributes

TCP/IP interface object attributes are associated with each instance, as follows:

Instance ID = 0 (class attributes):

Attribute ID	Description	GET	SET
01	Revision	X	—
02	Max Instance	X	—
X = supported — = not supported			

Instance ID = 1 (instance attributes):

Attribute ID	Description	Type	GET	SET	Value
01	Status	DWORD	X	—	0x01
02	Configuration Capability	DWORD	X	—	0x01 = from BootP 0x11 = from flash 0x00 = other
03	Configuration Control	DWORD	X	X	0x01 = out-of-box default
04	Physical Link Object	STRUCT	X	—	
	Path Size	UINT			
	Path	Padded EPATH			
X = supported — = not supported					

Attribute ID	Description	Type	GET	SET	Value
05	Interface Configuration	STRUCT	X	X	0x00 = out-of-box default
	IP Address	UDINT			
	Network Mask	UDINT			
	Gateway Address	UDINT			
	Name Server	UDINT			
	Name Server 2	UDINT			
	Domain Name	STRING			
06	Host Name	STRING	X	—	
X = supported — = not supported					

Services

The TCP/IP interface object performs the following services upon the listed object types:

Service ID		Description	Class	Instance	Notes
hex	dec				
01	01	Get_Attributes_All	X	X	Returns the value of all attributes.
0E	14	Get_Attribute_Single	X	X	Returns the value of the specified attribute.
10	16	Set_Attribute_Single ¹	—	X	Sets the value of the specified attribute.
X = supported — = not supported					
1. The Set_Attribute_Single service can execute only when these preconditions are satisfied: <ul style="list-style-type: none"> ● Configure the Ethernet communication module to obtain its IP address from flash memory. ● Confirm that the PLC is in stop mode. 					

Ethernet Link Object

Overview

The Ethernet Link object consists of the instances, attributes and services described below.

Class ID

F6 (hex), 246 (decimal)

Instance IDs

The Ethernet Link object presents the following instance values:

- 0: class
- 1: port 1
- 2: port 2
- 3: port 3
- 4: port 4
- 5: internal port

Attributes

The Ethernet Link object presents the following attributes:

Instance ID = 0 (class attributes):

Attribute ID	Description	GET	SET
01	Revision	X	—
02	Max Instance	X	—
03	Number of Instances	X	—
X = supported — = not supported			

Instance ID = 1...5 (instance attributes):

Attribute ID		Description	Type	GET	SET	Value
hex	dec					
01	01	Interface Speed	UDINT	X	—	Valid values include: 0, 10000000, 100000000
02	02	Interface Flags	DWORD	X	—	Bit 0: Link Status 0 = Inactive 1 = Active
						Bit 1: Duplex Mode 0 = half duplex 1 = full duplex
						Bits 2—4: Negotiation Status 3 = successfully negotiated speed and duplex 4 = forced speed and link
						Bit 5: Manual Setting Requires Reset 0 = automatic 1 = device need reset
						Bit 6: Local Hardware Fault detected 0 = no event 1 = event detected
03	03	Physical Address	ARRAY of 6 USINT	X	—	Module MAC Address
X = supported — = not supported						

Attribute ID		Description	Type	GET	SET	Value
hex	dec					
04	04	Interface Counters	STRUCT	X	—	
		In octets	UDINT			Octets received on the interface
		In Ucast Packets	UDINT			Unicast packets received on the interface
		In NUcast Packets	UDINT			Non-unicast packets received on the interface
		In Discards	UDINT			Inbound packets received on the interface, but discarded
		In Errors	UDINT			Inbound packets that contain detected errors (does not include In Discards)
		In Unknown Protos	UDINT			Inbound packets with unknown protocol
		Out Octets	UDINT			Octets sent on the interface
		Out Ucast Packets	UDINT			Unicast packets sent on the interface
		Out NUcast Packets	UDINT			Non-unicast packets sent on the interface
		Out Discards	UDINT			Outbound packets discarded
		Out Errors	UDINT			Outbound packets that contain detected errors
X = supported — = not supported						

Attribute ID		Description	Type	GET	SET	Value
hex	dec					
05	05	Media Counters	STRUCT	X	—	
		Alignment Errors	UDINT			Frames that are not an integral number of octets in length
		FCS Errors	UDINT			CRC error detected—Frames received with a detected FCS checksum error
		Single Collisions	UDINT			Successfully transmitted frames that experienced exactly one collision
		Multiple Collisions	UDINT			Successfully transmitted frames that experienced more than one collision
		SQE Test Errors	UDINT			Number of times the SQE test error is detected
		Deferred Transmissions	UDINT			Frames for which first transmission attempt is delayed because the medium is busy
		Late Collisions	UDINT			Number of times a collision is detected later than 512 bittimes into the transmission of a packet
		Excessive Collisions	UDINT			Frames for which transmission is not successful due to excessive collisions
		MAC Transmit Errors	UDINT			Frames for which transmission is not successful due to internal MAC sublayer transmit detected error
		Carrier Sense Errors	UDINT			Times that the carrier sense condition was lost or not asserted when attempting to transmit a frame
		Frame Too Long	UDINT			Frames received that exceed the maximum permitted frame size
		MAC Receive Errors	UDINT			Frames for which reception on an interface is not successful due to an internal MAC sublayer receive detected error
X = supported — = not supported						

Attribute ID		Description	Type	GET	SET	Value
hex	dec					
06	06	Interface Control	STRUCT	X	X	API of the connection
		Control Bits	WORD			Bit 0: Auto-negotiation 0 = Disabled 1 = Enabled Note: When auto-negotiation is enabled, the detected error 0x0C (Object State Conflict) is returned when attempting to set either: <ul style="list-style-type: none"> • Forced Interface Speed, or • Forced Duplex Mode
		Forced Interface Speed	UINT			Bit 1: Forced Duplex Mode (if auto-negotiation bit = 0) 0 = half duplex 1 = full duplex Valid values include: 10000000, 100000000 Note: Attempting to set any other value returns the detected error 0x09 (Invalid Attribute Value)
10	16	Interface Label	SHORT_STRING	X	—	A fixed textual string identifying the interface, that should include 'internal' for internal interfaces. Maximum number of characters is 64.
X = supported — = not supported						

Services

The Ethernet Link object performs the following services upon the listed object types:

Service ID		Description	Class	Instance
hex	dec			
01	01	Get_Attributes_All	X	X
10	16	Set_Attribute_Single	—	X
0E	14	Get_Attribute_Single	X	X
4C	76	Get_and_Clear	—	X
X = supported — = not supported				

EtherNet/IP Interface Diagnostics Object

Overview

The EtherNet/IP Interface Diagnostics object presents the instances, attributes and services described below.

Class ID

350 (hex), 848 (decimal)

Instance IDs

The EtherNet/IP Interface object presents two instance values:

- 0: class
- 1: instance

Attributes

EtherNet/IP Interface Diagnostics object attributes are associated with each instance, as follows:

Instance ID = 0 (class attributes):

Attribute ID	Description	GET	SET
01	Revision	X	—
02	Max Instance	X	—
X = supported — = not supported			

Instance ID = 1 (instance attributes):

Attribute ID	Description	Type	GET	SET	Value
01	Protocols Supported	UINT	X	—	
02	Connection Diagnostics	STRUCT	X	—	
	Max CIP IO Connections opened	UINT			Number of Class 1 connections opened since the last reset
	Current CIP IO Connections	UINT			Number of Class 1 connections currently opened
	Max CIP Explicit Connections opened	UINT			Number of Class 3 connections opened since the last reset
	Current CIP Explicit Connections	UINT			Number of Class 3 connections currently opened
	CIP Connections Opening Errors	UINT			Increments each time a Forward Open is not successful (Originator and Target)
	CIP Connections Timeout Errors	UINT			Increments when a connection times out (Originator and Target)
	Max EIP TCP Connections opened	UINT			Number of TCP connections (used for EIP, as client or server) opened since the last reset
Current EIP TCP Connections	UINT			Number of TCP connections (used for EIP, as client or server) currently open	
X = supported — = not supported					

Attribute ID	Description	Type	GET	SET	Value
03	IO Messaging Diagnostics	STRUCT	X	X	
	IO Production Counter	UDINT			Increments each time a Class 0/1 message is sent
	IO Consumption Counter	UDINT			Increments each time a Class 0/1 message is received
	IO Production Send Errors Counter	UINT			Increments each time a Class 0/1 message is not sent
	IO Consumption Receive Errors Counter	UINT			Increments each time a consumption is received with a detected error
04	Explicit Messaging Diagnostics	STRUCT	X	X	
	Class 3 Msg Send Counter	UDINT			Increments each time a Class 3 message is sent (client and server)
	Class 3 Msg Receive Counter	UDINT			Increments each time a Class 3 message is received (client and server)
	UCMM Msg Receive Counter	UDINT			Increments each time a UCMM message is sent (client and server)
	UCMM Msg Receive Counter	UDINT			Increments each time a UCMM message is received (client and server)
X = supported — = not supported					

Services

The EtherNet/IP Interface Diagnostics object performs the following services upon the listed object types:

Service ID		Description	Class	Instance	Notes
hex	dec				
01	01	Get_Attributes_All	X	X	Returns the value of all attributes.
0E	14	Get_Attribute_Single	—	X	Returns the value of the specified attribute.
4C	76	Get_and_Clear	—	X	Returns and clears the values of all instance attributes.
X = supported — = not supported					

EtherNet/IP IO Scanner Diagnostics Object

Overview

The EtherNet/IP IO Scanner Diagnostics object presents the instances, attributes and services described below.

Class ID

351 (hex), 849 (decimal)

Instance IDs

The EtherNet/IP IO Scanner Diagnostics object presents two instances:

- 0: class
- 1: instance

Attributes

EtherNet/IP IO Scanner Diagnostics object attributes are associated with each instance, as follows:

Instance ID = 0 (class attributes):

Attribute ID	Description	GET	SET
01	Revision	X	—
02	Max Instance	X	—
X = supported — = not supported			

Instance ID = 1 (instance attributes):

Attribute ID	Description	Type	GET	SET
01	IO Status Table	STRUCT	X	—
	Size	UINT		
	Status	ARRAY of UNINT		
X = supported — = not supported				

Services

The EtherNet/IP IO Scanner Diagnostics object performs the following services upon the listed object types:

Service ID		Description	Class	Instance	Notes
hex	dec				
01	01	Get_Attributes_All	X	X	Returns the value of all attributes.
0E	14	Get_Attribute_Single	X	X	Returns the value of the specified attribute.

X = supported
— = not supported

IO Connection Diagnostics Object

Overview

The IO Connection Diagnostics object presents the instances, attributes and services described below.

Class ID

352 (hex), 850 (decimal)

Instance IDs

The IO Connection Diagnostics object presents two instance values:

- 0: class
- 1...256: instance (The instance number is the connection number in the configuration.)

Attributes

IO Connection Diagnostics object attributes are associated with each instance, as follows:

Instance ID = 0 (class attributes):

Attribute ID	Description	GET	SET
01	Revision	X	—
02	Max Instance	X	—
X = supported — = not supported			

Instance ID = 1 to 256 (instance attributes):

Attribute ID	Description	Type	GET	SET	Value
01	IO Communication Diagnostics	STRUCT	X	X	
	IO Production Counter	UDINT			Increments at each production
	IO Consumption Counter	UDINT			Increments at each consumption
	IO Production Send Errors Counter	UINT			Increments each time a production is not sent
	IO Consumption Receive Errors Counter	UINT			Increments each time a consumption is received with a detected error
	CIP Connection Timeout Errors	UINT			Increments when a connection times out
	CIP Connection Opening Errors	UINT			Increments each time a connection is unable to open
	CIP Connection State	UINT			State of the Connection Bit
	CIP Last Error General Status	UINT			General status of the last error detected on the connection
	CIP Last Error Extended Status	UINT			Extended status of the last error detected on the connection
	Input Communication Status	UINT			Communication status of the inputs (see table, below)
Output Communication Status	UINT			Communication status of the outputs (see table, below)	
X = supported — = not supported					

Attribute ID	Description	Type	GET	SET	Value
02	Connection Diagnostics	STRUCT	X	X	
	Production Connection ID	UDINT			Connection ID for production
	Consumption Connection ID	UDINT			Connection ID for consumption
	Production RPI	UDINT			RPI for production
	Production API	UDINT			API for production
	Consumption RPI	UDINT			RPI for consumption
	Consumption API	UDINT			API for consumption
	Production Connection Parameters	UDINT			Connection parameters for production
	Consumption Connection Parameters	UDINT			Connection parameters for consumption
	Local IP	UDINT			—
	Local UDP Port	UINT			—
	Remote IP	UDINT			—
	Remote UDP Port	UINT			—
	Production Multicast IP	UDINT			Multicast IP used for production (or 0)
	Consumption Multicast IP	UDINT			Multicast IP used for consumption (or 0)
	Protocols Supported	UDINT			Protocol supported on the connection: 1 = EtherNet/IP
X = supported — = not supported					

The following values describe the structure of the instance attributes: *CIP Connection State*, *Input Communication Status*, and *Output Communication Status*.

Bit Number	Description	Values
15...3	<i>Reserved</i>	0
2	Idle	0 = no idle notification 1 = idle notification
1	Consumption inhibited	0 = consumption started 1 = no consumption
0	Production inhibited	0 = production started 1 = no production

Services

The EtherNet/IP Interface Diagnostics object performs the following services upon the listed object types:

Service ID		Description	Class	Instance	Notes
hex	dec				
01	01	Get_Attributes_All	X	X	Returns the value of all attributes.
0E	14	Get_Attribute_Single	—	X	Returns the value of the specified attribute.
4C	76	Get_and_Clear	—	X	Returns and clears the values of all instance attributes.

X = supported
— = not supported

EtherNet/IP Explicit Connection Diagnostics Object

Overview

The EtherNet/IP Explicit Connection Diagnostics object presents the instances, attributes and services described below.

Class ID

353 (hex), 851 (decimal)

Instance IDs

The EtherNet/IP Explicit Connection Diagnostics object presents two instance values:

- 0: class
- 1...*N*: instance (*N* = maximum concurrent number of explicit connections)

Attributes

EtherNet/IP Explicit Connection Diagnostics object attributes are associated with each instance, as follows:

Instance ID = 0 (class attributes):

Attribute ID hex	Description	Value	GET	SET
01	Revision	1	X	—
02	Max Instance	0... <i>N</i>	X	—
X = supported — = not supported				

Instance ID = 1 to *N* (instance attributes):

Attribute ID hex	Description	Type	GET	SET	Value
01	Originator connection ID	UDINT	X	—	Originator to target connection ID
02	Originator IP	UINT	X	—	
03	Originator TCP Port	UDINT	X	—	
04	Target connection ID	UDINT	X	—	Target to originator connection ID
05	Target IP	UDINT	X	—	
06	Target TCP Port	UDINT	X	—	
X = supported — = not supported					

Attribute ID hex	Description	Type	GET	SET	Value
07	Msg Send Counter	UDINT	X	—	Incremented each time a Class 3 CIP message is sent on the connection
08	Msg Receive counter	UDINT	X	—	Increments each time a Class 3 CIP message is received on the connection
X = supported — = not supported					

Services

The EtherNet/IP Explicit Connection Diagnostics object performs the following services upon the listed object type:

Service ID		Description	Class	Instance	Notes
hex	dec				
01	01	Get_Attributes_All	X	X	Returns the value of all attributes.
X = supported — = not supported					

EtherNet/IP Explicit Connection Diagnostics List Object

Overview

The EtherNet/IP Explicit Connection Diagnostics List object presents the instances, attributes and services described below.

Class ID

354 (hex), 852 (decimal)

Instance IDs

The EtherNet/IP Explicit Connection Diagnostics List object presents two instance values:

- 0: class
- 1...*N*: instance

Attributes

EtherNet/IP Explicit Connection Diagnostics List object attributes are associated with each instance, as follows:

Instance ID = 0 (class attributes):

Attribute ID	Description	GET	SET
01	Revision	X	—
02	Max Instance	X	—
X = supported — = not supported			

Instance ID = 1 to N (instance attributes):

Attribute ID	Description	Type	GET	SET	Value
01	Number of connections	UINT	X	—	Total number of opened explicit connections
02	Explicit Messaging Connections Diagnostic List	ARRAY of STRUCT	X	—	
	Originator connection ID	UDINT			O->T connection ID
	Originator IP	UINT			—
	Originator TCP port	UDINT			—
	Target connection ID	UDINT			T->O connection ID
	Target IP	UDINT			—
	Target TCP port	UDINT			—
	Msg Send counter	UDINT			Increments each time a Class 3 CIP message is sent on the connection
Msg Receive counter	UDINT			Increments each time a Class 3 CIP message is received on the connection	
X = supported — = not supported					

Services

The EtherNet/IP Explicit Connection Diagnostics object performs the following services upon the listed object types:

Service ID		Description	Class	Instance	Notes
hex	dec				
01	01	Get_Attributes_All	X	—	Returns the value of all attributes.
08	08	Create	X	—	—
09	09	Delete	—	X	—
4B	75	Explicit_Connections_Diagnostic_Read	—	X	—
X = supported — = not supported					

Chapter 7

Online Action

Overview

The Ethernet communication module supports online actions that let you:

- display CIP objects for the communication module or a remote EtherNet/IP device
- view and edit port configuration parameters for the communication module or a remote EtherNet/IP device
- ping the communication module or a remote EtherNet/IP or Modbus TCP device to confirm it is active on the Ethernet network
- connect to a remote device and then:
 - view the remote device's default parameter settings
 - view the remote device's current parameter settings
 - edit and download to the remote device its editable parameter settings

What Is in This Chapter?

This chapter contains the following topics:

Topic	Page
Accessing CIP Objects	278
Editing Port Configuration Properties for Remote EtherNet/IP Devices	280
Pinging a Network Device	282
Viewing and Editing Online Settings for a Remote Device	284

Accessing CIP Objects

Overview

Use the **Module Information** page of the **Online Action** window to:

- retrieve and display current data describing the state of CIP objects for the selected communication module or remote EtherNet/IP device, and
- reset the selected communication module or remote EtherNet/IP device

NOTE: Before you can perform online actions for a communication module or remote device, connect its DTM to the physical module or device. To do this, select the module or device node in the **DTM Browser**, then select **Edit** → **Connect**.

The appearance of this page, and the CIP object information you can retrieve, depend upon the operating mode of the Control Expert software:

In this mode...	You can display data for these CIP objects...
Standard mode	Identity object (<i>see page 245</i>)
Advanced mode (<i>see page 50</i>)	<ul style="list-style-type: none"> ● Identity object ● Connection Manager object (<i>see page 249</i>) ● TCP/IP Interface object (<i>see page 255</i>) ● Ethernet Link object (<i>see Quantum using EcoStruxure™ Control Expert, 140 NOC 771 01 Ethernet Communication Module, User Manual</i>) ● QoS object (<i>see page 253</i>)

The **Module Information** page looks like this:

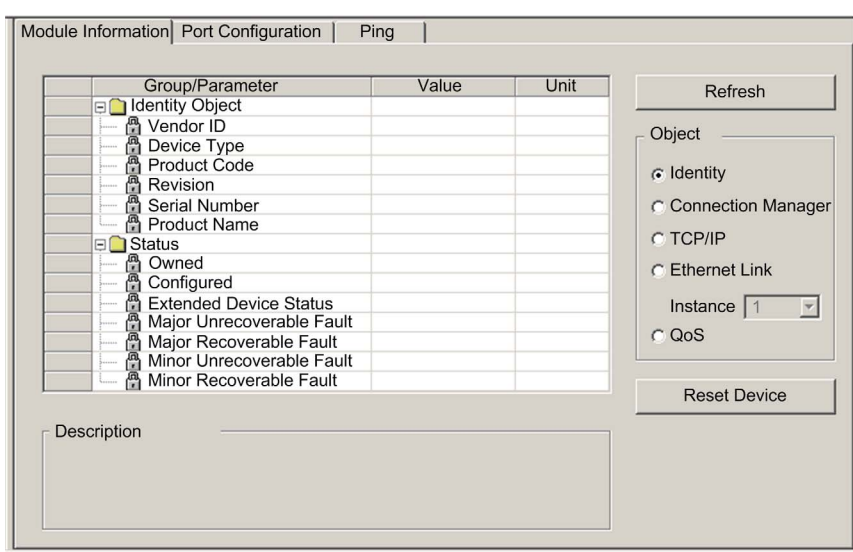

Retrieve and Display CIP Object Data

To display CIP object data for an EtherNet/IP communication module or remote device:

Step	Action
1	In the DTM Browser , select a communication module.
2	Click the right mouse button, and in the pop-up menu select Device menu → Online Action . The Online Action window opens.
3	In the left pane of the Online Action window, select a communication module or EtherNet/IP device.
4	In the right pane, click on the Module Information tab to open that page.
5	<p>If Control Expert is operating in Advanced Mode</p> <ul style="list-style-type: none"> ● Select one of the following CIP objects: <ul style="list-style-type: none"> ○ Identity ○ Connection Manager ○ TCP/IP ○ Ethernet Link ○ QoS ● If you selected a multi-port module or device in step 3, above, select an Interface, or port, number <p>NOTE: If Control Expert is operating in Standard Mode, it will display data only for the CIP Identity object.</p>
6	Click the Refresh button to update the data displayed.

Reset a Communication Module or Remote EtherNet/IP Device

To reset a communication module or remote EtherNet/IP device:

Step	Action
1	In the DTM Browser , select a communication module.
2	Click the right mouse button, and in the pop-up menu select Device menu → Online Action . The Online Action window opens.
3	In the left pane of the Online Action window, select a communication module or EtherNet/IP device.
4	In the right pane, click on the Module Information tab to open that page.
5	Click the Reset Device button.

Editing Port Configuration Properties for Remote EtherNet/IP Devices

Overview

Use the **Port Configuration** page of the **Online Action** window to view and edit communication port properties for a remote EtherNet/IP device. Specifically, you can use this page to execute a:

- Get command to retrieve port configuration settings from a remote EtherNet/IP device
- Set command that writes all or selected edited values to the same remote EtherNet/IP device

Configuration edits transmitted from this page are sent as EtherNet/IP explicit messages and employ the **Address** and **Messaging** settings configured in the **EtherNet/IP Explicit Messaging** window.

NOTE: Before you can perform online actions for a remote device, connect its DTM to the physical device. To do this, select the device node in the **DTM Browser**, then select **Edit → Connect**.

The **Port Configuration** page looks like this:

Group/Parameter	Value	Unit
General		
▶ Startup Configuration		
▶ DNS Enable		
TCP/IP Parameters		
▶ Device IP Address		
▶ New IP Address		
▶ Gateway Address		
▶ Sub Network Mask		
▶ Primary DNS Server Address		
▶ Secondary DNS Server		
▶ Domain Name		
Host Name		
▶ Name		
Physical Interface		
▶ Get: Link Status		
▶ Get: Duplex Mode		
▶ Get: Negotiation Status		
▶ Get: Interface Speed		Mbps
▶ Set: 802.3 Link Auto-Negotiation	Disable	
▶ Set: Forced Duplex Mode	Half Duplex	
▶ Set: Forced Interface Speed	Indeterminate	Mbps

Physical Interface Instance
 Refresh

Get Values from Device

Set All Values to Device

Set Part of Values

General
 TCP/IP Parameters
 Host Name
 Physical Interface

Set Values to Device

Description

Get Port Configuration Settings

To get settings from a remote EtherNet/IP device on the network:

Step	Action
1	In the DTM Browser , select the communication module upstream of the remote EtherNet/IP device.
2	Click the right mouse button, and in the pop-up menu select Device menu → EtherNet/IP Explicit Message . The EtherNet/IP Explicit Message window opens.
3	In the EtherNet/IP Explicit Messaging page, complete the Address section. Note: Port configuration explicit messages are sent as unconnected messages.
4	Return to the DTM Browser and again select the communication module upstream of the remote EtherNet/IP device.
5	Click the right mouse button, and in the pop-up menu select Device menu → Online Action . The Online Action window opens.
6	In the left pane of the Online Action window, select a remote EtherNet/IP device.
7	In the right pane, click on the Port Configuration tab to open that page.
8	If the remote device consists of more than one port, select the port number in the Physical Interface Instance list.
9	In the Port Configuration page, click the Get Values from Device button. The table displays the returned values of the communication properties for the selected remote device and port.

Edit and Set Port Configuration Settings

To edit and set port configuration settings that were retrieved using the above-described **Get Port Configuration Settings** process:

Step	Action
1	Double-click the left mouse button in the Value cell for the parameter you want to edit. The cell becomes editable. Note: The page also displays a Description of the selected parameter.
2	Type in, or select, the new value.
3	Repeat steps 1 - 2 for each parameter you want to edit.
4	Do one of the following: <ul style="list-style-type: none"> ● Click the Set All Values to Device to write every value to the remote device - or - ● if you edited parameters for only one part, or group, of the collection of remote device values, then: <ul style="list-style-type: none"> ○ in the Set Part of Values area, select one property group, then ○ click the Set Values to Device button <p>Control Expert sends the property value edits to the remote device via an EtherNet/IP explicit message, and displays the results in the Description area.</p>

Pinging a Network Device

Overview

Use the Control Expert ping function to send an ICMP echo request to a target Ethernet device to determine:

- if the target device is present, and if so
- the elapsed time to receive an echo response from the target device

The target device is identified by its IP address setting. Control Expert will verify that the target address is not a:

- loopback address (127.000.000.000 to 127.255.255.255)
- multicast address (224.000.000.000 to 239.255.255.255)
- reserved address (240.000.000.000 to 255.255.255.255)
- broadcast address

The ping function can be performed in the **Ping** page of the **Online Action** window:

The screenshot shows the 'Online Action' window with the 'Ping' tab selected. The 'Address' section contains an 'IP Address' field with the value '192.168.1.6'. The 'Ping' section includes a 'Ping' button, two unchecked checkboxes for 'Repeat (100ms)' and 'Stop on Error', and a 'Clear' button. A 'Ping Result' text area is located to the right of the 'Ping' section.

Pinging a Network Device

To ping a network device:

Step	Action
1	In the DTM Browser , select the communication module upstream of the remote EtherNet/IP device you want to ping.
2	Click the right mouse button and select Device Menu > → Online Action in the pop-up menu. The Online Action window opens.
3	In the Online Action window, select the device you want to ping. The window displays pages containing online information for the selected device. NOTE: The specific collection of displayed pages depends on the type of device selected: <ul style="list-style-type: none"> ● the communication module ● a remote EtherNet/IP device ● a remote Modbus TCP device
4	Select the Ping page. To send... <ul style="list-style-type: none"> ● a single ping, de-select the Repeat checkbox ● a series of pings—1 every 100 ms—select Repeat checkbox
5	(Optional) Select Stop on Error to stop pinging an unsuccessful communication.
6	Click Ping once to begin pinging.
7	Click Ping a second time to stop repeated pinging, where no error has been detected.
8	The Ping Result box displays the ping outcome. Click Clear to empty the Ping Result box.

Viewing and Editing Online Settings for a Remote Device

Introduction

Use the **Online Parameters** window to:

- view the remote device's default parameter settings
- view the remote device's current parameter settings
- edit and download to the remote device its editable parameter settings

Parameter setting edits transmitted from this page are sent as EtherNet/IP explicit messages and employ the **Address** and **Messaging** settings configured in the **EtherNet/IP Explicit Messaging** window.

NOTE: Before you can view and edit online settings for a remote device, connect its DTM file to the physical device. To do this, select the device node in the **DTM Browser**, then select **Edit** → **Connect**.

To open the **Online Parameters** window, follow these steps:

Step	Action
1	In the DTM Browser , select the node for a remote device.
2	Click the right mouse button, and in the pop-up menu select Device menu → Online Parameters . The Online Parameters window opens for the selected remote device.
3	In the left pane of the Online Parameters window, select a connection node. Control Expert displays the parameters relating to the selected connection in the right pane. NOTE: The list of parameters displayed in the Online Parameters window depends upon: <ul style="list-style-type: none">● the device selected in the DTM Browser, and● the connection selected in the left pane of the Online Parameters window

An example of the **Online Parameters** window—in this case for the STB NIC 2212 remote network interface device—looks like this:

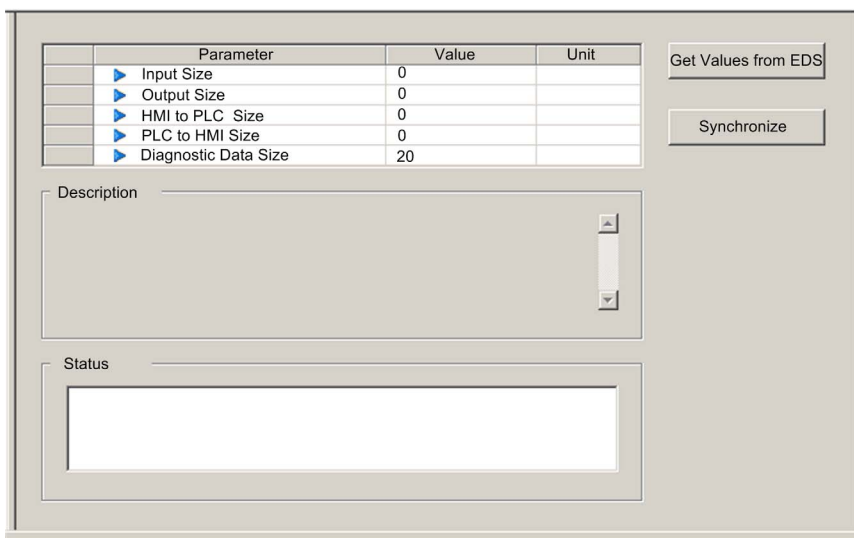

Read-only parameters are identified by a locked icon  .

Editable parameters are identified by a blue arrowhead  .

Displaying Default Parameter Settings

To view the default parameter settings for the remote device, click the **Get Values from EDS** button. Control Expert reads the default device values from its EDS file and displays them on-screen.

Displaying Online Parameter Settings

To view the current parameter settings for the remote device, follow these steps:

Step	Action
1	With a connection selected in the left pane, click the Synchronize button. The Synchronize Action message box opens.
2	In the message box, select Read values from the device , then click OK . The message box closes. In the Online Parameters window: <ul style="list-style-type: none"> the Status field displays the results of the read transaction the parameter list displays current values

Editing Online Parameter Settings

To edit parameter settings for the remote device, follow these steps:

Step	Action
1	With a connection selected in the left pane, display either: <ul style="list-style-type: none">● default device settings, or● current device settings
2	In the Value column, type in or select a new value for each setting you want to edit. NOTE: When you select a parameter, the Description area displays an explanation of the parameter and its available settings.
3	Click the Synchronize button. The Synchronize Action message box opens.
4	In the message box, select Write data to the device , then click OK . The message box closes. In the Online Parameters window, the Status field displays the results of the write transaction.

Chapter 8

Explicit Messaging

Overview

The BMX NOC 0401 Ethernet communication module supports explicit messaging by means of both the EtherNet/IP and Modbus TCP protocols.

To create an explicit message for the EtherNet/IP protocol, use the `DATA_EXCH` function block in application logic.

To create an explicit message for the Modbus TCP protocol, use any one of the following function blocks in application logic: `DATA_EXCH`, `READ_VAR`, or `WRITE_VAR`.

NOTE: A single Control Expert application can contain more than 16 explicit messaging blocks, but only 16 explicit messaging blocks can be active at the same time.

This chapter describes how to configure both EtherNet/IP and Modbus TCP explicit messages by using:

- the `DATA_EXCH` function block in application logic
- the Control Expert graphical user interface

What Is in This Chapter?

This chapter contains the following sections:

Section	Topic	Page
8.1	Explicit Messaging Using the <code>DATA_EXCH</code> Block	288
8.2	EtherNet/IP Explicit Messaging Using <code>DATA_EXCH</code>	293
8.3	Modbus TCP Explicit Messaging Using <code>DATA_EXCH</code>	310
8.4	Explicit Messaging via the Control Expert GUI	319

Section 8.1

Explicit Messaging Using the DATA_EXCH Block

Overview

This section introduces you to the `DATA_EXCH` function block, which you can use to configure both EtherNet/IP and Modbus TCP explicit messages.

This section describes how to configure the `DATA_EXCH` function block's Management parameter, which is common to both Modbus TCP and EtherNet/IP explicit messaging.

What Is in This Section?

This section contains the following topics:

Topic	Page
Configuring Explicit Messaging Using <code>DATA_EXCH</code>	289
Configuring the <code>DATA_EXCH</code> Management Parameter	291

Configuring Explicit Messaging Using DATA_EXCH

Overview

Use the `DATA_EXCH` function block to configure both Modbus TCP explicit messages and connected and unconnected EtherNet/IP explicit messages.

The `Management_Param`, the `Data_to_Send`, and the `Received_Data` parameters define the operation.

`EN` and `ENO` can be configured as additional parameters.

FBD Representation

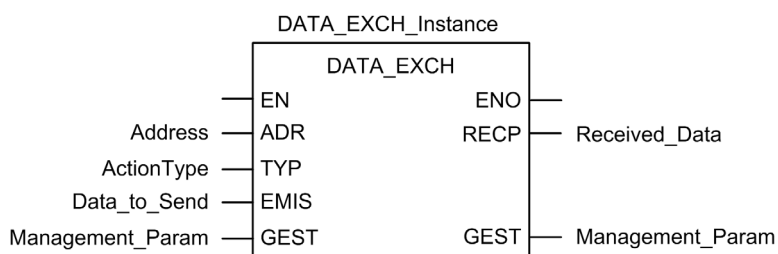

Input Parameters

Parameter	Data type	Description
EN	BOOL	This parameter is optional. When this input is set to one, the block is activated and can solve the function blocks algorithm. When this input is set to zero, the block is deactivated and won't solve the function block algorithm.
Address	Array [0...7] of INT	The path to the destination device, the content of which can vary depending on the message protocol. Use the <code>Address</code> function as an input to the block parameter <code>ADR</code> .. Refer to a description of the <code>Address</code> parameter for: <ul style="list-style-type: none"> • EtherNet/IP messages (see page 296) • Modbus TCP messages (see page 312)
ActionType	INT	The type of action to perform. For both the EtherNet/IP and Modbus TCP protocols, this setting = 1 (transmission followed by await reception).
Data_to_Send	Array [n...m] of INT	The content of this parameter is specific to the protocol, either EtherNet/IP or Modbus TCP. For EtherNet/IP explicit messaging, refer to the topic Configuring the Data_To_Send Parameter (see page 296) . For Modbus TCP explicit messaging, refer to Control Expert online help .

Input/Output Parameters

The `Management_Param` array is local:

Parameter	Data type	Description
<code>Management_Param</code>	Array [0...3] of INT	The management parameter (<i>see page 291</i>), consisting of four words.

Do not copy this array during a switchover from a primary to a standby CPU in a Hot Standby system. Uncheck the **Exchange On STBY** variable in Control Expert when you configure a Hot Standby system.

NOTE: Refer to the description of Hot Standby system data management and the `T_M_ECPU_HSBY` DDT (*see Modicon M580 Hot Standby, System Planning Guide for, Frequently Used Architectures*) in the M580 Hot Standby System Planning Guide (*see Modicon M580 Hot Standby, System Planning Guide for, Frequently Used Architectures*).

Output Parameters

Parameter	Data type	Description
<code>ENO</code>	BOOL	This parameter is optional. When you select this output you also get the EN input. ENO output is activated upon successful execution of the function block.
<code>Received_Data</code>	Array [n...m] of INT	The EtherNet/IP (CIP) response (<i>see page 297</i>) or the Modbus TCP response (<i>see page 313</i>). The structure and content depends upon the specific protocol.

Configuring the DATA_EXCH Management Parameter

Introduction

The structure and content of the management parameter of the `DATA_EXCH` block is common to both EtherNet/IP and Modbus TCP explicit messaging.

Configuring the Management Parameter

The management parameter consists of four contiguous words:

Data source	Register	Description	
		High Byte (MSB)	Low Byte (LSB)
Data managed by the system	Management_Param[0]	Exchange number	Two read-only bits: <ul style="list-style-type: none"> ● Bit 0 = Activity bit (<i>see page 292</i>) ● Bit 1 = Cancel bit
	Management_Param[1]	Operation report (<i>see page 424</i>)	Communication report (<i>see page 423</i>)
Data managed by the user	Management_Param[2]	Block timeout. Values include: <ul style="list-style-type: none"> ● 0 = infinite wait ● other values = timeout x 100 ms, for example: <ul style="list-style-type: none"> ○ 1 = 100 ms ○ 2 = 200 ms 	
	Management_Param[3]	Length of data sent or received: <ul style="list-style-type: none"> ● Input (before sending the request): length of data in the <code>Data_to_Send</code> parameter, in bytes ● Output (after response): length of data in the <code>Received_Data</code> parameter, in bytes 	

Activity Bit

The activity bit is the first bit of the first element in the table. The value of this bit indicates the execution status of the communication function:

- **1**: The bit is set to 1 when the function launches.
- **0**: The bit returns to 0 upon the completion of the execution. (The transition from 1 to 0 increments the exchange number. If an error is detected during the execution, search for the corresponding code in the operation and communication report (*see page 423*).

For example, you can make this declaration in the management table:

```
Management_Param[0] ARRAY [0..3] OF INT
```

For that declaration, the activity bit corresponds to this notation:

```
Management_Param[0].0
```

NOTE: The notation previously used requires configuration of the project properties in such a way as to authorize the extraction of bits on integer types. If this is not the case, `Management_Param[0].0` cannot be accessed in this manner.

Section 8.2

EtherNet/IP Explicit Messaging Using DATA_EXCH

Overview

This section shows you how to configure the `DATA_EXCH` function block for EtherNet/IP explicit messages.

What Is in This Section?

This section contains the following topics:

Topic	Page
Explicit Messaging Services	294
Configuring EtherNet/IP Explicit Messaging Using <code>DATA_EXCH</code>	296
EtherNet/IP Explicit Message Example: <code>Get_Attribute_Single</code>	298
EtherNet/IP Explicit Message Example: Read Modbus Object	302
EtherNet/IP Explicit Message Example: Write Modbus Object	306

Explicit Messaging Services

Overview

Every explicit message performs a service. Each service is associated with a service code (or number). You will need to identify the explicit messaging service by its name, decimal number, or hexadecimal number.

You can execute explicit messages using either the `DATA_EXCH` function block in Control Expert, or the Control Expert Ethernet Configuration Tool.

Services

The services available in Control Expert include, but are not limited to, the services listed below:

Service Code		Description	Available in...	
Hex	Dec		DATA_EXCH block	Control Expert GUI
0	0	<i>(Reserved)</i>	—	—
1	1	Get_Attributes_All	X	X
2	2	Set_Attributes_All	X	X
3	3	Get_Attribute_List	X	—
4	4	Set_Attribute_List	X	—
5	5	Reset	X	X
6	6	Start	X	X
7	7	Stop	X	X
8	8	Create	X	X
9	9	Delete	X	X
A	10	Multiple_Service_Packet	X	—
B-C	11-12	<i>(Reserved)</i>	—	—
D	13	Apply_Attributes	X	X
E	14	Get_Attribute_Single	X	X
F	15	<i>(Reserved)</i>	—	—
10	16	Set_Attribute_Single	X	X
11	17	Find_Next_Object_Instance	X	X
12-13	18-19	<i>(Reserved)</i>	—	—
14	20	Error Response (DeviceNet only)	—	—
15	21	Restore	X	X
16	22	Save	X	X
17	23	No Operation (NOP)	X	X

"X" indicates the service is available. "—" indicates the service is not available.

Service Code		Description	Available in...	
Hex	Dec		DATA_EXCH block	Control Expert GUI
18	24	Get_Member	X	X
19	25	Set_Member	X	X
1A	26	Insert_Member	X	X
1B	27	Remove_Member	X	X
1C	28	GroupSync	X	—
1D-31	29-49	(Reserved)	—	—

"X" indicates the service is available. "—" indicates the service is not available.

Configuring EtherNet/IP Explicit Messaging Using DATA_EXCH

Configuring the Address Parameter

To configure the Address parameter, use the `ADDM` function to convert the character string, described below, to an address that is input into the `ADR` parameter of the `DATA_EXCH` block: `ADDM('rack.slot.channel{ip_address}message_type.protocol')`, where:

This field...	Represents...
rack	the number assigned to the rack containing the communication module
slot	the position of the communication module in the rack
channel	the communication channel—set to a value of 0
ip_address	the IP address of the remote device, for example 193.168.1.6
message_type	the type of message, presented as a three character string—either: <ul style="list-style-type: none"> ● UNC (indicating an unconnected message), or ● CON (indicating a connected message)
protocol	the protocol type—the three character string CIP

Configuring the Data_to_Send Parameter

The `Data_to_Send` parameter varies in size. It consists of contiguous registers that include—in sequence—both the message type and the CIP request:

Offset (words)	Length (bytes)	Data Type	Description
0	2 bytes	Bytes	Message type: <ul style="list-style-type: none"> ● High byte = size of the request in words ● Low byte = EtherNet/IP service code
1	Management_Param[3] (size of Data_to_Send) minus 2	Bytes	The CIP request ¹ . NOTE: The structure and size of the CIP request depends on the EtherNet/IP service.
1 Structure the CIP request in little endian order.			

Contents of the Received_Data Parameter

The `Received_Data` parameter contains only the CIP response. The length of the CIP response varies, and is reported by `Management_Param[3]` after the response is received. The format of the CIP response is described, below:

Offset (words)	Length (bytes)	Data Type	Description
0	2	Byte	<ul style="list-style-type: none"> High byte (MSB) = reserved Low byte (LSB): reply service
1	2	Byte	<ul style="list-style-type: none"> High byte (MSB): length of additional status Low byte (LSB): EtherNet/IP general status (<i>see page 427</i>)
2	length of additional status	Byte array	Additional Status ¹
...	<code>Management_Param[3]</code> (size of <code>Received_Data</code>) minus 4, and minus the additional status length	Byte array	Response data

1. Refer to *The CIP Networks Library, Volume 1, Common Industrial Protocol* at section 3-5.6 *Connection Manager Object Instance Error Codes*.

NOTE: The response is structured in little endian order.

Checking the Received_Data Response for System and CIP Status

Use the contents of the `Received_Data` parameter to check both the system status and the CIP status of the Ethernet communication module when handling the explicit message.

First: Check the value of the high byte (MSB) of the first response word, positioned at offset 0. If the value of this byte is:

- equal to 0: the system properly handled the explicit message
- not equal to 0: a system-based event occurred

Refer to the list of EtherNet/IP Explicit Messaging Event Codes (*see page 420*) for an explanation of the system-based event code contained in the second response word, positioned at offset 1.

Next: If the system properly handled the explicit message, and the high byte of the first response word equals 0, check the value of the second response word, positioned at offset 1. If the value of this word is:

- equal to 0: the explicit message was properly handled by the CIP protocol
- not equal to 0: a CIP protocol-based event occurred

Refer to your CIP documentation for an explanation of the CIP status displayed in this word.

EtherNet/IP Explicit Message Example: Get_Attribute_Single

Overview

The following unconnected explicit messaging example shows you how to use the `DATA_EXCH` function block to retrieve diagnostic data from a remote device—in this case an STB NIC 2212 network interface module at IP address 192.168.1.6—using the `Get_Attribute_Single` service.

You can perform the same explicit messaging service using the **EtherNet/IP Explicit Message** window of the Control Expert Ethernet Configuration Tool (*see page 320*).

Implementing the `DATA_EXCH` Function Block

To implement the `DATA_EXCH` function block, you need to create and assign variables for the following blocks:

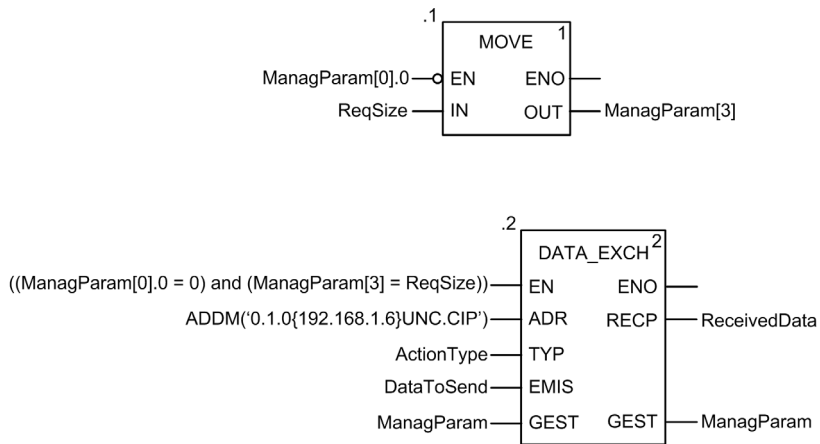

Declaring Variables

In this example, the following variables were defined. You can, of course, use different variable names in your explicit messaging configurations.

In this example, the following variables were defined. You can, of course, use different variable names in your explicit messaging configurations.

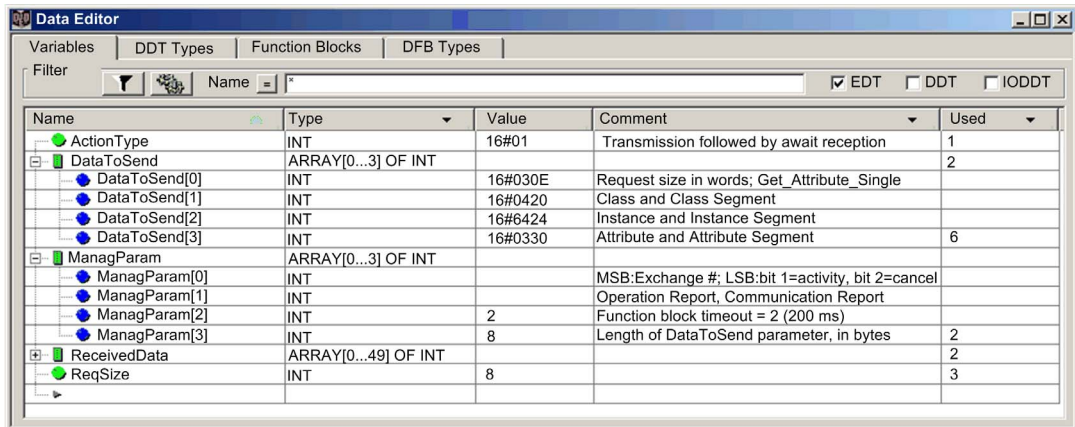

Name	Type	Value	Comment	Used
ActionType	INT	16#01	Transmission followed by await reception	1
DataToSend	ARRAY[0...3] OF INT			2
DataToSend[0]	INT	16#030E	Request size in words; Get_Attribute_Single	
DataToSend[1]	INT	16#0420	Class and Class Segment	
DataToSend[2]	INT	16#6424	Instance and Instance Segment	
DataToSend[3]	INT	16#0330	Attribute and Attribute Segment	6
ManagParam	ARRAY[0...3] OF INT			
ManagParam[0]	INT		MSB:Exchange #; LSB:bit 1=activity, bit 2=cancel	
ManagParam[1]	INT		Operation Report, Communication Report	
ManagParam[2]	INT	2	Function block timeout = 2 (200 ms)	
ManagParam[3]	INT	8	Length of DataToSend parameter, in bytes	2
ReceivedData	ARRAY[0...49] OF INT			2
ReqSize	INT	8		3

Configuring the Address Variable

The Address variable identifies the explicit message originating device (in this example, the communication module) and the target device. Note that the Address variable does not include the Xway address elements {Network.Station} because we are not bridging through another PLC station. Use the `ADDM` function to convert the following character string to an address:

`ADDM('0.1.0{192.168.1.6}UNC.CIP')`, where:

- rack = 0
- module (slot number) = 1
- channel = 0
- remote device IP address = 192.168.1.6
- message type = unconnected
- protocol = CIP

Configuring the ActionType Variable

The ActionType variable identifies the function type for the `DATA_EXCH` function block:

Variable	Description	Value (hex)
ActionType	Transmission followed by wait for response	16#01

Configuring the DataToSend Variable

The DataToSend variable identifies the type of explicit message and the CIP request:

Variable	Description	Value (hex)
DataToSend[0]	CIP request service information: <ul style="list-style-type: none"> High byte = request size in words: 16#03 (3 decimal) Low byte = service code: 16#0E (14 decimal) 	16#030E
DataToSend[1]	CIP request class information: <ul style="list-style-type: none"> High byte = class: 16#04 (4 decimal) Low byte = class segment: 16#20 (32 decimal) 	16#0420
DataToSend[2]	CIP request instance information: <ul style="list-style-type: none"> High byte = instance: 16#64 (100 decimal) Low byte = instance segment: 16#24 (36 decimal) 	16#6424
DataToSend[3]	CIP request attribute information: <ul style="list-style-type: none"> High byte = attribute: 16#03 (3 decimal) Low byte = attribute segment: 16#30 (48 decimal) 	16#0330

Viewing the Response

Use a Control Expert Animation table to display the ReceivedData variable array. Note that the ReceivedData variable array consists of the entire data buffer.

To display the CIP response, follow these steps:

Step	Action								
1	In Control Expert, select Tools → Project Browser to open the Project Browser.								
2	In the Project Browser, select the Animation Tables folder, then click the right mouse button. A pop-up menu appears.								
3	Select New Animation Table in the pop-up menu. A new animation table and its properties dialog both open.								
4	In the Properties dialog, edit the following values: <table border="1" data-bbox="281 1084 1200 1234"> <tbody> <tr> <td>Name</td> <td>Type in a table name. For this example: ReceivedData.</td> </tr> <tr> <td>Functional module</td> <td>Accept the default <None>.</td> </tr> <tr> <td>Comment</td> <td>(Optional) Type your comment here.</td> </tr> <tr> <td>Number of animated characters</td> <td>Type in 100, representing the size of the data buffer in words.</td> </tr> </tbody> </table>	Name	Type in a table name. For this example: ReceivedData .	Functional module	Accept the default <None> .	Comment	(Optional) Type your comment here.	Number of animated characters	Type in 100 , representing the size of the data buffer in words.
Name	Type in a table name. For this example: ReceivedData .								
Functional module	Accept the default <None> .								
Comment	(Optional) Type your comment here.								
Number of animated characters	Type in 100 , representing the size of the data buffer in words.								

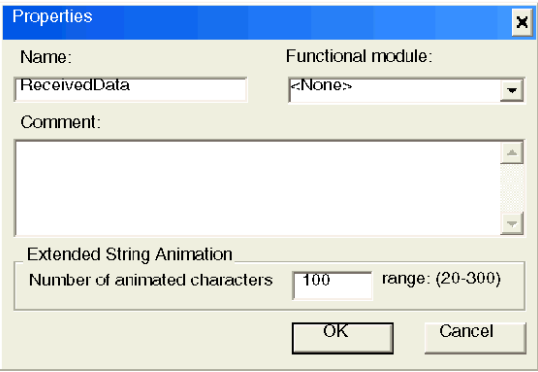
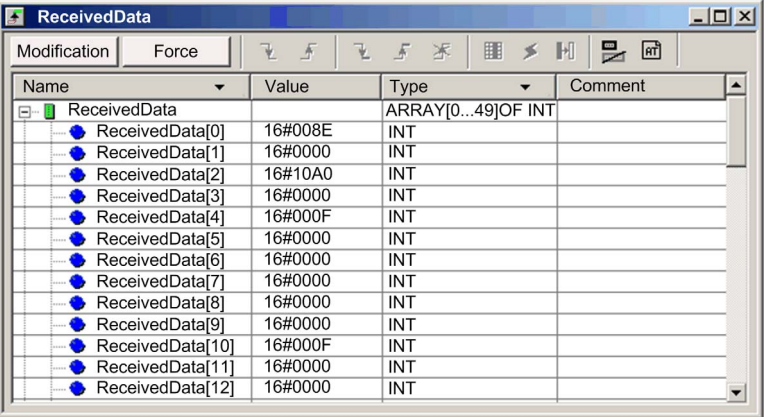
Step	Action
5	<p>The completed Properties dialog looks like this:</p>  <p>Click OK to close the dialog.</p>
6	<p>In the animation table's Name column, type in the name of the variable assigned to the RECP pin: ReceivedData and hit Enter. The animation table displays the ReceivedData variable.</p>
7	<p>Expand the ReceivedData variable to display its word array, where you can view the CIP response contained in the ReceivedData variable:</p>  <p>Note: Each array entry presents 2 bytes of data in little endian format, where the least significant byte is stored in the smallest memory address. For example, '8E' in word[0] is the lower byte, and '00' is the upper byte.</p>

EtherNet/IP Explicit Message Example: Read Modbus Object

Overview

The following unconnected explicit messaging example shows you how to use the `DATA_EXCH` function block to read data from a remote device—in this case an STB NIC 2212 network interface module at IP address 192.168.1.6—using the Read_Holding_Registers service of the Modbus Object.

You can perform the same explicit messaging service using the **EtherNet/IP Explicit Message** window of the Control Expert Ethernet Configuration Tool (*see page 320*).

Implementing the `DATA_EXCH` Function Block

To implement the `DATA_EXCH` function block, you need to create and assign variables for the following blocks:

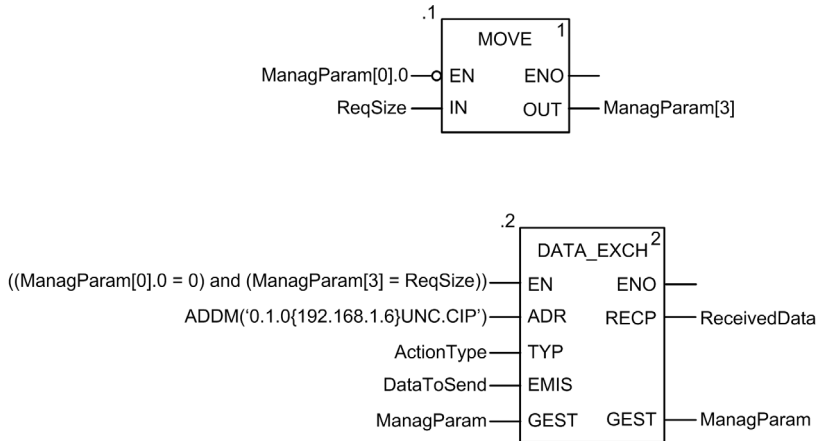

Declaring Variables

In this example, the following variables were defined. You can, of course, use different variable names in your explicit messaging configurations.

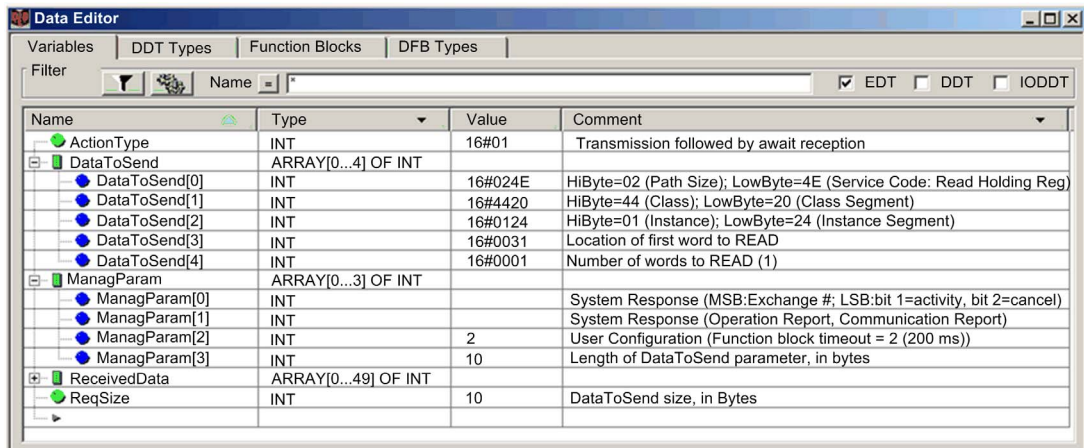

Configuring the Address Variable

The Address variable identifies the explicit message originating device (in this example, the Ethernet communication module) and the target device. Note that the Address variable does not include the Xway address elements {Network.Station} because we are not bridging through another PLC station. Use the `ADDMM` function to convert the following character string to an address:

`ADDMM('0.1.0{192.168.1.6}UNC.CIP')`, where:

- rack = 0
- module (slot number) = 1
- channel = 0
- remote device IP address = 192.168.1.6
- message type = unconnected
- protocol = CIP

Configuring the ActionType Variable

The ActionType variable identifies the function type for the `DATA_EXCH` function block:

Variable	Description	Value (hex)
ActionType	Transmission followed by wait for response	16#01

Configuring the DataToSend Variable

The DataToSend variable identifies the type of explicit message and the CIP request:

Variable	Description	Value (hex)
DataToSend[0]	CIP request service information: <ul style="list-style-type: none"> High byte = request size in words: 16#02 (2 decimal) Low byte = service code: 16#4E (78 decimal) 	16#024E
DataToSend[1]	CIP request class information: <ul style="list-style-type: none"> High byte = class: 16#44 (68 decimal) Low byte = class segment: 16#20 (32 decimal) 	16#4420
DataToSend[2]	CIP request instance information: <ul style="list-style-type: none"> High byte = instance: 16#01 (1 decimal) Low byte = instance segment: 16#24 (36 decimal) 	16#0124
DataToSend[3]	Location of first word to be read: <ul style="list-style-type: none"> High byte = 16#00 (0 decimal) Low byte = 16#31 (49 decimal) 	16#0031
DataToSend[4]	Number of words to read: <ul style="list-style-type: none"> High byte = attribute: 16#00 (0 decimal) Low byte = attribute segment: 16#01 (1 decimal) 	16#0001

Viewing the Response

Use a Control Expert Animation table to display the ReceivedData variable array. Note that the ReceivedData variable array consists of the entire data buffer.

To display the CIP response, follow these steps:

Step	Action								
1	In Control Expert, select Tools → Project Browser to open the Project Browser.								
2	In the Project Browser, select the Animation Tables folder, then click the right mouse button. A pop-up menu appears.								
3	Select New Animation Table in the pop-up menu. A new animation table and its properties dialog both open.								
4	In the Properties dialog, edit the following values: <table border="1" data-bbox="281 1182 1200 1352"> <tbody> <tr> <td>Name</td> <td>Type in a table name. For this example: ReceivedData.</td> </tr> <tr> <td>Functional module</td> <td>Accept the default <None>.</td> </tr> <tr> <td>Comment</td> <td>(Optional) Type your comment here.</td> </tr> <tr> <td>Number of animated characters</td> <td>Type in 49, representing the size of the data buffer in words.</td> </tr> </tbody> </table>	Name	Type in a table name. For this example: ReceivedData .	Functional module	Accept the default <None> .	Comment	(Optional) Type your comment here.	Number of animated characters	Type in 49 , representing the size of the data buffer in words.
Name	Type in a table name. For this example: ReceivedData .								
Functional module	Accept the default <None> .								
Comment	(Optional) Type your comment here.								
Number of animated characters	Type in 49 , representing the size of the data buffer in words.								

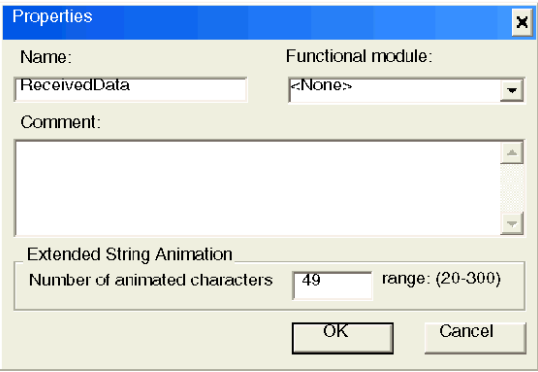
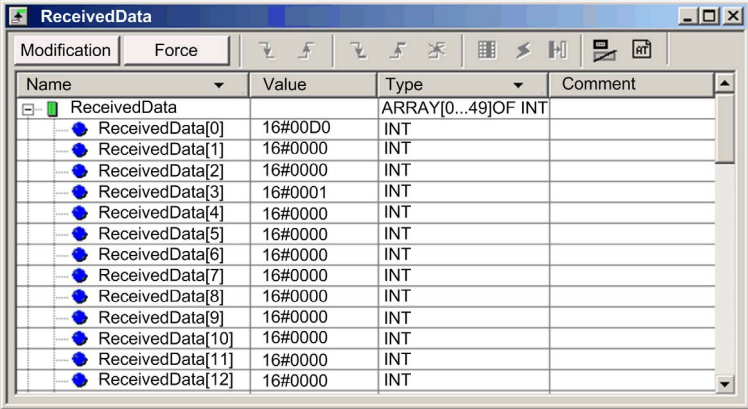
Step	Action																																																												
5	<p>The completed Properties dialog looks like this:</p>  <p>Click OK to close the dialog.</p>																																																												
6	<p>In the animation table's Name column, type in the name of the variable assigned to the RECP pin: ReceivedData and hit Enter. The animation table displays the ReceivedData variable.</p>																																																												
7	<p>Expand the ReceivedData variable to display its word array, where you can view the CIP response contained in the ReceivedData variable:</p>  <table border="1" data-bbox="322 885 1070 1209"> <thead> <tr> <th>Name</th> <th>Value</th> <th>Type</th> <th>Comment</th> </tr> </thead> <tbody> <tr> <td>ReceivedData</td> <td>ARRAY[0...49]OF INT</td> <td></td> <td></td> </tr> <tr> <td>ReceivedData[0]</td> <td>16#00D0</td> <td>INT</td> <td></td> </tr> <tr> <td>ReceivedData[1]</td> <td>16#0000</td> <td>INT</td> <td></td> </tr> <tr> <td>ReceivedData[2]</td> <td>16#0000</td> <td>INT</td> <td></td> </tr> <tr> <td>ReceivedData[3]</td> <td>16#0001</td> <td>INT</td> <td></td> </tr> <tr> <td>ReceivedData[4]</td> <td>16#0000</td> <td>INT</td> <td></td> </tr> <tr> <td>ReceivedData[5]</td> <td>16#0000</td> <td>INT</td> <td></td> </tr> <tr> <td>ReceivedData[6]</td> <td>16#0000</td> <td>INT</td> <td></td> </tr> <tr> <td>ReceivedData[7]</td> <td>16#0000</td> <td>INT</td> <td></td> </tr> <tr> <td>ReceivedData[8]</td> <td>16#0000</td> <td>INT</td> <td></td> </tr> <tr> <td>ReceivedData[9]</td> <td>16#0000</td> <td>INT</td> <td></td> </tr> <tr> <td>ReceivedData[10]</td> <td>16#0000</td> <td>INT</td> <td></td> </tr> <tr> <td>ReceivedData[11]</td> <td>16#0000</td> <td>INT</td> <td></td> </tr> <tr> <td>ReceivedData[12]</td> <td>16#0000</td> <td>INT</td> <td></td> </tr> </tbody> </table> <p>Note: Each array entry presents 2 bytes of data in little endian format, where the least significant byte is stored in the smallest memory address. For example, 'CE' in word[0] is the lower byte, and '00' is the upper byte.</p>	Name	Value	Type	Comment	ReceivedData	ARRAY[0...49]OF INT			ReceivedData[0]	16#00D0	INT		ReceivedData[1]	16#0000	INT		ReceivedData[2]	16#0000	INT		ReceivedData[3]	16#0001	INT		ReceivedData[4]	16#0000	INT		ReceivedData[5]	16#0000	INT		ReceivedData[6]	16#0000	INT		ReceivedData[7]	16#0000	INT		ReceivedData[8]	16#0000	INT		ReceivedData[9]	16#0000	INT		ReceivedData[10]	16#0000	INT		ReceivedData[11]	16#0000	INT		ReceivedData[12]	16#0000	INT	
Name	Value	Type	Comment																																																										
ReceivedData	ARRAY[0...49]OF INT																																																												
ReceivedData[0]	16#00D0	INT																																																											
ReceivedData[1]	16#0000	INT																																																											
ReceivedData[2]	16#0000	INT																																																											
ReceivedData[3]	16#0001	INT																																																											
ReceivedData[4]	16#0000	INT																																																											
ReceivedData[5]	16#0000	INT																																																											
ReceivedData[6]	16#0000	INT																																																											
ReceivedData[7]	16#0000	INT																																																											
ReceivedData[8]	16#0000	INT																																																											
ReceivedData[9]	16#0000	INT																																																											
ReceivedData[10]	16#0000	INT																																																											
ReceivedData[11]	16#0000	INT																																																											
ReceivedData[12]	16#0000	INT																																																											

EtherNet/IP Explicit Message Example: Write Modbus Object

Overview

The following unconnected explicit messaging example shows you how to use the `DATA_EXCH` function block to write data to a remote device—in this case an STB NIC 2212 network interface module at IP address 192.168.1.6—using the Write_Holding_Registers service of the Modbus Object.

You can perform the same explicit messaging service using the **EtherNet/IP Explicit Message** window of the Control Expert Ethernet Configuration Tool (*see page 320*).

Implementing the `DATA_EXCH` Function Block

To implement the `DATA_EXCH` function block, you need to create and assign variables for the following blocks:

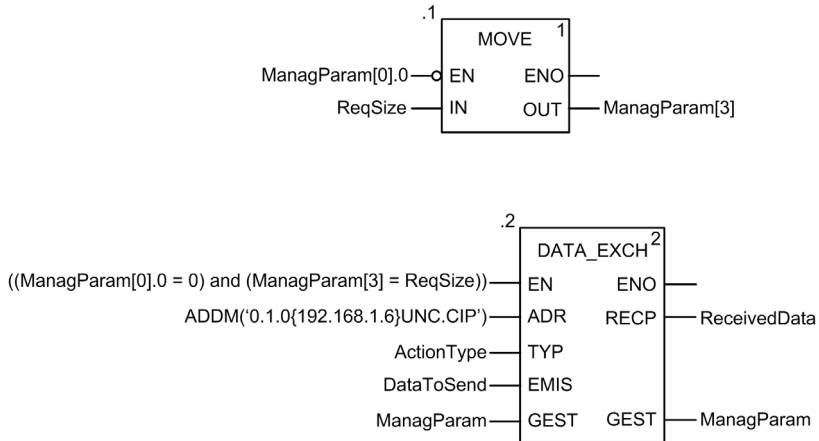

Declaring Variables

In this example, the following variables were defined. You can, of course, use different variable names in your explicit messaging configurations.

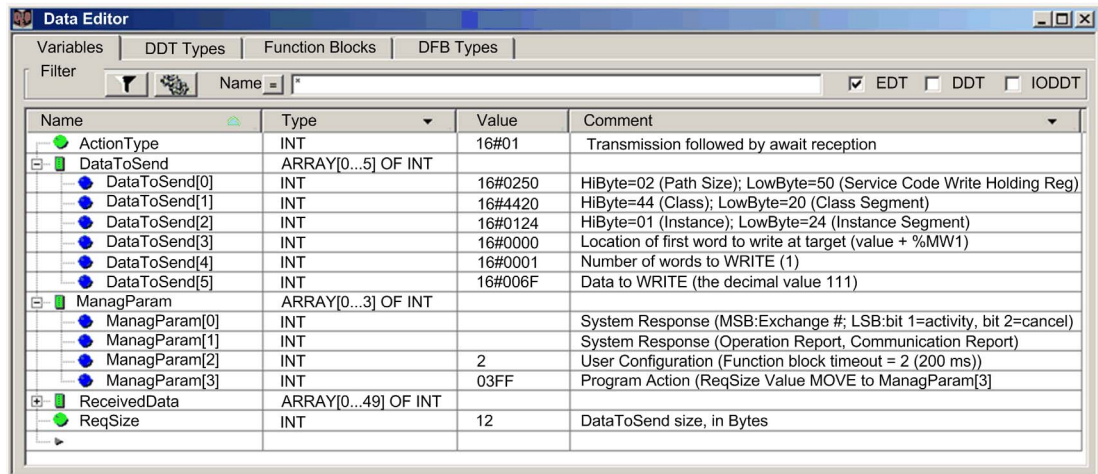

Name	Type	Value	Comment
ActionType	INT	16#01	Transmission followed by await reception
DataToSend	ARRAY[0...5] OF INT		
DataToSend[0]	INT	16#0250	HiByte=02 (Path Size); LowByte=50 (Service Code Write Holding Reg)
DataToSend[1]	INT	16#4420	HiByte=44 (Class); LowByte=20 (Class Segment)
DataToSend[2]	INT	16#0124	HiByte=01 (Instance); LowByte=24 (Instance Segment)
DataToSend[3]	INT	16#0000	Location of first word to write at target (value + %MW1)
DataToSend[4]	INT	16#0001	Number of words to WRITE (1)
DataToSend[5]	INT	16#006F	Data to WRITE (the decimal value 111)
ManagParam	ARRAY[0...3] OF INT		
ManagParam[0]	INT		System Response (MSB:Exchange #; LSB:bit 1=activity, bit 2=cancel)
ManagParam[1]	INT		System Response (Operation Report, Communication Report)
ManagParam[2]	INT	2	User Configuration (Function block timeout = 2 (200 ms))
ManagParam[3]	INT	03FF	Program Action (ReqSize Value MOVE to ManagParam[3])
ReceivedData	ARRAY[0...49] OF INT		
ReqSize	INT	12	DataToSend size, in Bytes

Configuring the Address Variable

The Address variable identifies the explicit message originating device (in this example, the communication module) and the target device. Note that the Address variable does not include the Xway address elements {Network.Station} because we are not bridging through another PLC station. Use the `ADDMM` function to convert the following character string to an address:

`ADDMM('0.1.0{192.168.1.6}UNC.CIP')`, where:

- rack = 0
- module (slot number) = 1
- channel = 0
- remote device IP address = 192.168.1.6
- message type = unconnected
- protocol = CIP

Configuring the ActionType Variable

The ActionType variable identifies the function type for the `DATA_EXCH` function block:

Variable	Description	Value (hex)
ActionType	Transmission followed by wait for response	16#01

Configuring the DataToSend Variable

The DataToSend variable identifies the type of explicit message and the CIP request:

Variable	Description	Value (hex)
DataToSend[0]	CIP request service information: <ul style="list-style-type: none"> High byte = request size in words: 16#02 (2 decimal) Low byte = service code: 16#50 (80 decimal) 	16#0250
DataToSend[1]	CIP request class information: <ul style="list-style-type: none"> High byte = class: 16#44 (68 decimal) Low byte = class segment: 16#20 (32 decimal) 	16#4420
DataToSend[2]	CIP request instance information: <ul style="list-style-type: none"> High byte = instance: 16#01 (1 decimal) Low byte = instance segment: 16#24 (36 decimal) 	16#0124
DataToSend[3]	Location of first word to write (+ %MW1): <ul style="list-style-type: none"> High byte = 16#00 (0 decimal) Low byte = 16#00 (0 decimal) 	16#0000
DataToSend[4]	Number of words to write: <ul style="list-style-type: none"> High byte = attribute: 16#00 (0 decimal) Low byte = attribute segment: 16#01 (1 decimal) 	16#0001
DataToSend[5]	Data to write: <ul style="list-style-type: none"> High byte = attribute: 16#00 (0 decimal) Low byte = attribute segment: 16#6F (111 decimal) 	16#006F

Viewing the Response

Use a Control Expert Animation table to display the ReceivedData variable array. Note that the ReceivedData variable array consists of the entire data buffer.

To display the CIP response, follow these steps:

Step	Action								
1	In Control Expert, select Tools → Project Browser to open the Project Browser.								
2	In the Project Browser, select the Animation Tables folder, then click the right mouse button. A pop-up menu appears.								
3	Select New Animation Table in the pop-up menu. A new animation table and its properties dialog both open.								
4	In the Properties dialog, edit the following values: <table border="1" data-bbox="281 1274 1186 1446"> <tbody> <tr> <td>Name</td> <td>Type in a table name. For this example: ReceivedData.</td> </tr> <tr> <td>Functional module</td> <td>Accept the default <None>.</td> </tr> <tr> <td>Comment</td> <td>(Optional) Type your comment here.</td> </tr> <tr> <td>Number of animated characters</td> <td>Type in 49, representing the size of the data buffer in words.</td> </tr> </tbody> </table>	Name	Type in a table name. For this example: ReceivedData .	Functional module	Accept the default <None> .	Comment	(Optional) Type your comment here.	Number of animated characters	Type in 49 , representing the size of the data buffer in words.
Name	Type in a table name. For this example: ReceivedData .								
Functional module	Accept the default <None> .								
Comment	(Optional) Type your comment here.								
Number of animated characters	Type in 49 , representing the size of the data buffer in words.								

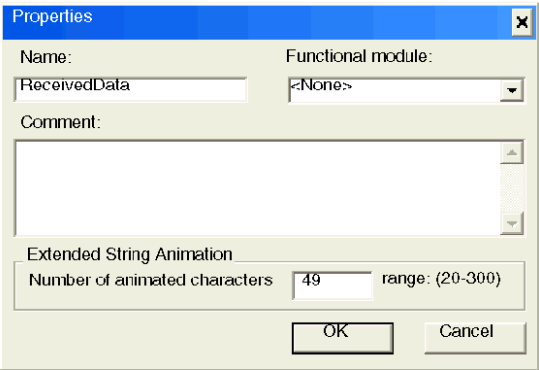
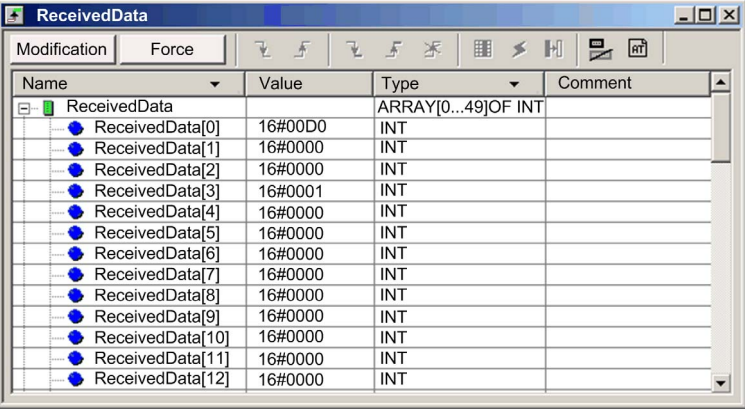
Step	Action
5	<p>The completed Properties dialog looks like this:</p>  <p>Click OK to close the dialog.</p>
6	<p>In the animation table's Name column, type in the name of the variable assigned to the RECP pin: ReceivedData and hit Enter. The animation table displays the ReceivedData variable.</p>
7	<p>Expand the ReceivedData variable to display its word array, where you can view the CIP response contained in the ReceivedData variable:</p>  <p>Note: Each array entry presents 2 bytes of data in little endian format, where the least significant byte is stored in the smallest memory address. For example, 'D0' in word[0] is the lower byte, and '00' is the upper byte.</p>

Section 8.3

Modbus TCP Explicit Messaging Using DATA_EXCH

Overview

This section shows you how to configure `DATA_EXCH` function block parameters for Modbus TCP explicit messages.

What Is in This Section?

This section contains the following topics:

Topic	Page
Modbus TCP Explicit Messaging Function Codes	311
Configuring Modbus TCP Explicit Messaging Using <code>DATA_EXCH</code>	312
Modbus TCP Explicit Message Example: Read Register Request	314

Modbus TCP Explicit Messaging Function Codes

Overview

You can execute Modbus TCP explicit messages using either a Control Expert `DATA_EXCH` function block or the Control Expert Ethernet Configuration Tool's **Modbus Explicit Message Window**.

NOTE: Configuration edits made to an Ethernet communication module from the Control Expert Ethernet Configuration Tool are not saved to the operating parameters stored in the CPU and, therefore, are not sent by the CPU to the module on startup.

Function Codes

The function codes supported by the Control Expert graphical user interface include the following standard explicit messaging functions:

Function Code (dec)	Description
1	Read bits (%M)
2	Read input bits (%I)
3	Read words (%MW)
4	Read input words (%IW)
15	Write bits (%M)
16	Write words (%MW)

NOTE: You can use the `DATA_EXCH` function block to execute any Modbus function, via program logic. Because the available function codes are too numerous to list here, refer instead to the Modbus IDA website for more information about these Modbus functions, at:
<http://www.Modbus.org>.

Configuring Modbus TCP Explicit Messaging Using DATA_EXCH

Introduction

When you use the `DATA_EXCH` block to create an explicit message for a Modbus TCP device, configure this block the same way you would configure it for any other Modbus communication. Refer to the Control Expert online help for instructions on how to configure the `DATA_EXCH` block.

Configuring ADDM Block Unit ID Settings

When you configure the `DATA_EXCH` block, use the `ADDM` block to set the `DATA_EXCH` block's Address parameter. The `ADDM` block presents the configuration format `ADDM('rack.slot.channel[ip_address]UnitID.message_type.protocol')` where:

The parameter...	Represents...
rack	the number assigned to the rack containing the communication module
slot	the position of the communication module in the rack
channel	the communication channel—set to a value of 0
ip_address	the IP address of the remote device, for example, 192.168.1.7
Unit ID	the destination node address, also known as the Modbus Plus on Ethernet Transporter (MET) mapping index value
message_type	the three character string TCP
protocol	the three character string MBS

The Unit ID value in a Modbus message indicates the destination of the message. The manner in which the communication module handles the Unit ID value depends upon its role as either a server or a client. When the communication module acts as a:

- **server:** a message with Unit ID value of 255 is directed to and processed by the communication module itself. Other messages are passed to the CPU.
- **client:** a message with Unit ID value of 255 is directed to and handled by the communication module itself. Other values are passed to the CPU.

Modbus function code 3 provides easy access to a variety of diagnostic functions, including basic network diagnostics, Ethernet port diagnostics, and Modbus port 502 diagnostics.

To access the function code 3 diagnostics (*see Quantum EIO, Distributed I/O Network, Installation and Configuration Guide*) from the local device, set the Unit ID to 255.

Contents of the Received_Data Parameter

The `Received_Data` parameter contains the Modbus response. The length of the response varies, and is reported by `Management_Param[3]` after the response is received. The format of the Modbus response is described, below:

Offset (words)	Length (bytes)	Description
0	2	First word of the Modbus response: <ul style="list-style-type: none"> ● High byte (MSB): <ul style="list-style-type: none"> ○ if successful: Modbus Function Code ○ if not: Modbus function code + 16#80 ● Low byte (LSB): <ul style="list-style-type: none"> ○ if successful: depends on the request ○ if not: Modbus exception code (<i>see page 431</i>)
1	Length of the <code>Received_Data</code> parameter – 2	Remainder of the Modbus response: depends on the specific Modbus request)

NOTE: Structure the response in little endian order.

Modbus TCP Explicit Message Example: Read Register Request

Overview

The following example shows you how to use the `DATA_EXCH` function block to send an explicit messaging Modbus TCP request to a remote device—in this case an STB NIP 2212 network interface module at IP address 192.168.1.7—to read a single word located in the remote device at register 5391.

Implementing the `DATA_EXCH` Function Block

To implement the `DATA_EXCH` function block, you need to create and assign variables for the following blocks:

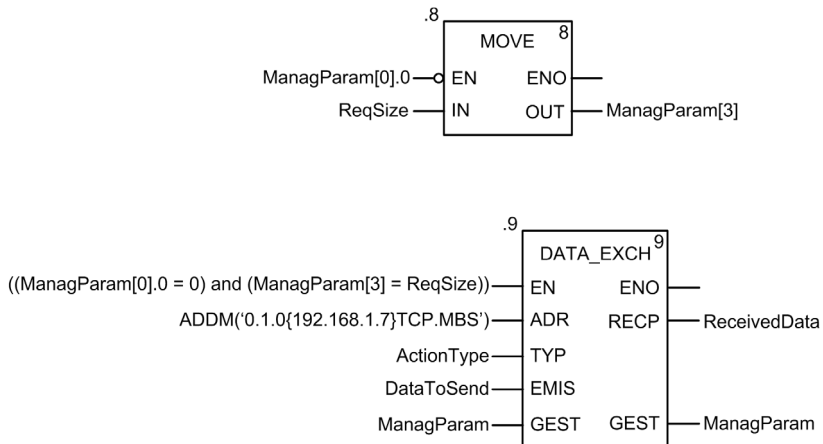

Declaring Variables

In this example, the following variables were defined. You can, of course, use different variable names in your explicit messaging configurations.

In this example, the following variables were defined. You can, of course, use different variable names in your explicit messaging configurations.

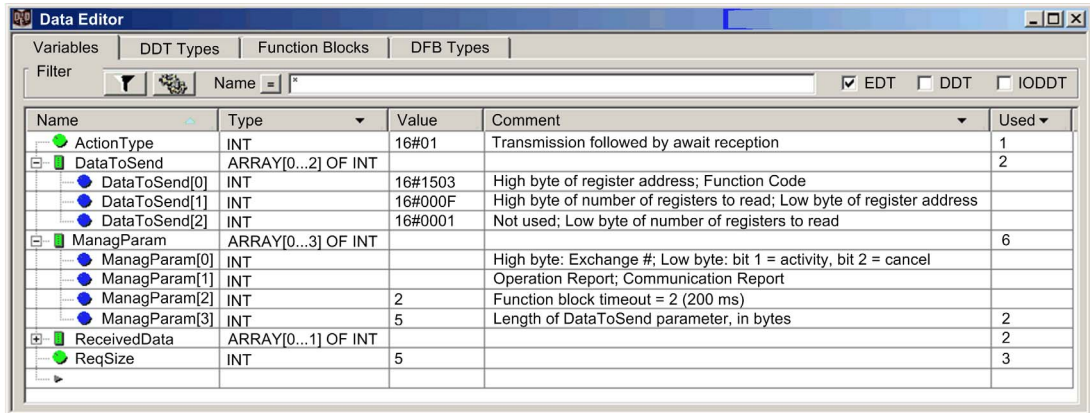

The screenshot shows the 'Data Editor' window with a table of variables. The table has columns for Name, Type, Value, Comment, and Used. The variables are:

Name	Type	Value	Comment	Used
ActionType	INT	16#01	Transmission followed by await reception	1
DataToSend	ARRAY[0...2] OF INT			2
DataToSend[0]	INT	16#1503	High byte of register address; Function Code	
DataToSend[1]	INT	16#000F	High byte of number of registers to read; Low byte of register address	
DataToSend[2]	INT	16#0001	Not used; Low byte of number of registers to read	
ManagParam	ARRAY[0...3] OF INT			6
ManagParam[0]	INT		High byte: Exchange #; Low byte: bit 1 = activity, bit 2 = cancel	
ManagParam[1]	INT		Operation Report; Communication Report	
ManagParam[2]	INT	2	Function block timeout = 2 (200 ms)	
ManagParam[3]	INT	5	Length of DataToSend parameter, in bytes	2
ReceivedData	ARRAY[0...1] OF INT			2
ReqSize	INT	5		3

Configuring the Address Variable

The Address variable identifies the explicit message originating device (in this example, the communication module) and the target device. Note that the Address variable does not include the Unit ID element. Use the `ADDM` function to convert the following character string to an address:

`ADDM('0.1.0{192.168.1.7}TCP.MBS')`, where:

- rack = 0
- module (slot number) = 1
- channel = 0
- remote device IP address = 192.168.1.7
- message type = TCP
- protocol = Modbus

NOTE: As indicated above, the configuration of the ADDM function in this example does not include a Unit ID element, which – if included – would be inserted after the “}” following the remote device IP address and would be followed by a “.” (e.g., `ADDM('0.1.0{192.168.1.7}0.TCP.MBS')`, where 0 is the Unit ID). The configuration of the ADDM function, as set forth above, will work for most Modbus TCP devices. However, there may be some exceptions, as noted below:

- Unit ID = 255: The absence of an express Unit ID value will be interpreted as Unit ID = 255. For some devices, a Unit ID of 255 is used to access Ethernet diagnostic data through Modbus TCP (via Modbus FC03 “Read Holding Registers”). Refer to the Quantum platform topic Supported Diagnostic Codes (*see Quantum EIO, Control Network, Installation and Configuration Guide*) for diagnostics available to Modbus TCP devices.
- Unit ID 100: For other Modbus TCP devices, Unit ID = 100 is used for the same purpose as Unit ID = 255, as described above. Refer to the Modicon M580 platform topic Diagnostics Available through Modbus/TCP (*see Modicon M580, Hardware, Reference Manual*) for additional information.

Configuring the ActionType Variable

The ActionType variable identifies the function type for the DATA_EXCH function block:

Variable	Description	Value (hex)
ActionType	Transmission followed by wait for response	16#01

Configuring the DataToSend Variable

The DataToSend variable contains the target register address and the number of registers to read:

Variable	Description	Value (hex)
DataToSend[0]	<ul style="list-style-type: none"> ● High byte = Most significant byte (MSB) of register address 16#15 (21 decimal) ● Low byte = function code: 16#03 (03 decimal) 	16#1503
DataToSend[1]	<ul style="list-style-type: none"> ● High byte = Most significant byte (MSB) of the number of registers to read: 16#00 (0 decimal) ● Low byte = Least significant byte (LSB) of register address: 16#0F (15 decimal) 	16#000F
DataToSend[2]	CIP request instance information: <ul style="list-style-type: none"> ● High byte = not used: 16#00 (0 decimal) ● Low byte = Least significant byte (LSB) of the number of registers to read: 16#01 (1 decimal) 	16#0001

Viewing the Response

Use a Control Expert Animation table to display the ReceivedData variable array. Note that the ReceivedData variable array consists of the entire data buffer.

To display the Modbus TCP response, follow these steps:

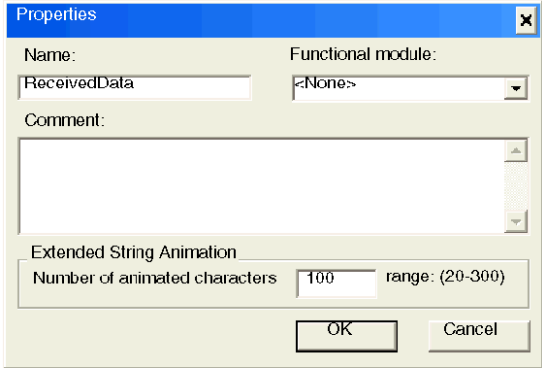
Step	Action								
1	In Control Expert, select Tools → Project Browser to open the Project Browser.								
2	In the Project Browser, select the Animation Tables folder, then click the right mouse button. A pop-up menu appears.								
3	Select New Animation Table in the pop-up menu. A new animation table and its properties dialog both open.								
4	In the Properties dialog, edit the following values: <table border="1" data-bbox="312 548 1166 722"> <tr> <td>Name</td> <td>Type in a table name. For this example: ReceivedData.</td> </tr> <tr> <td>Functional module</td> <td>Accept the default <None>.</td> </tr> <tr> <td>Comment</td> <td>(Optional) Type your comment here.</td> </tr> <tr> <td>Number of animated characters</td> <td>Type in 100, representing the size of the data buffer in words.</td> </tr> </table>	Name	Type in a table name. For this example: ReceivedData .	Functional module	Accept the default <None> .	Comment	(Optional) Type your comment here.	Number of animated characters	Type in 100 , representing the size of the data buffer in words.
Name	Type in a table name. For this example: ReceivedData .								
Functional module	Accept the default <None> .								
Comment	(Optional) Type your comment here.								
Number of animated characters	Type in 100 , representing the size of the data buffer in words.								
5	<p>The completed Properties dialog looks like this:</p>  <p>Click OK to close the dialog.</p>								
6	In the animation table's Name column, type in the name of the variable assigned to the databuffer: ReceivedData and hit Enter . The animation table displays the ReceivedData variable.								

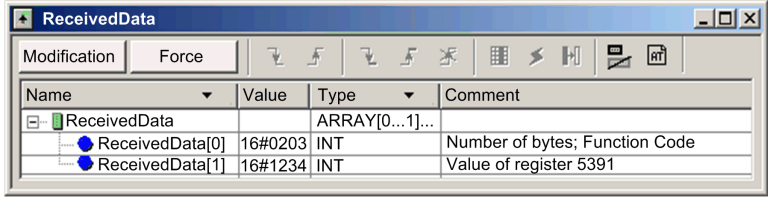
Step	Action
7	<p data-bbox="289 204 1201 253">Expand the ReceivedData variable to display its word array, where you can view the CIP response contained in the ReceivedData variable:</p>  <p data-bbox="289 500 1201 548">Note: Each array entry presents 2 bytes of data in little endian format. For example, '03' in word[0] is the low byte, and '02' is the high byte.</p>

Section 8.4

Explicit Messaging via the Control Expert GUI

What Is in This Section?

This section contains the following topics:

Topic	Page
Sending Explicit Messages to EtherNet/IP Devices	320
Sending Explicit Messages to Modbus TCP Devices	323

Sending Explicit Messages to EtherNet/IP Devices

Overview

Use the **EtherNet/IP Explicit Message** window to send an explicit message from Control Expert to an EtherNet/IP module or device on the network.

An explicit message can be sent as either a connected, or an unconnected message:

- an unconnected message requires path — or addressing — information identifying the destination device and, optionally, device attributes
- a connected explicit message contains both path information and a connection identifier to the target device

You can use explicit messaging to perform many different services. Not every EtherNet/IP device supports every service.

NOTE: Before you can perform explicit messaging, connect the DTM for the upstream communication module to the module itself. To do this, select the module node in the **DTM Browser**, then select **Edit** → **Connect**.

The **EtherNet/IP Explicit Message** window, below, presents an example of both the configuration of an EtherNet/IP explicit message and the response. The explicit message is addressed to a remote STB NIC 2212 network interface module to obtain diagnostic information.

The screenshot shows the 'EtherNet/IP Explicit Message' window with the following configuration:

- Address:** IP Address: 192 . 168 . 1 . 6; Class: 4; Instance: 100; Attribute: 3
- Service:** Number: 14; Name: Get_Attribute_Single; Enter Path (hex); Path: 20 04 24 64 30 03
- Data(hex):** (Empty field)
- Messaging:** Connected; Unconnected
- Repeat (500ms):**
- Response(hex):** A0 10 00 00 0F 00 00 00;
00 00 00 00 00 00 00 00;
0F 00 00 00 ;
- Status:** Status = 0(0x00), Status EtherNet/IP = 0(0x00)

Sending Explicit Messages

The following steps explain how to execute the EtherNet/IP explicit message, depicted above:

Step	Action	
1	In the DTM Browser , select the communication module that is upstream of the target device.	
2	Click the right mouse button, and in the pop-up menu select Device menu → EtherNet/IP Explicit Message . Result: The EtherNet/IP Explicit Message window opens.	
3	Configure the explicit message using the following fields:	
	IP Address	The IP address of the target device, used to identify the target of the explicit message. In the above example: 192.168.1.6 .
	Class	The class identifier of the target device, used in the construction of the message path. An integer from 1 to 65535. In this example: 4 .
	Instance	The class instance of the target device, used in the construction of the message path. An integer from 0 to 65535. In this example: 100 .
	Attribute	(Optional) The specific device attribute — or property — that is the target of the explicit message, used in the construction of the message path. An integer from 0 to 65535. In this example: 3 NOTE: Select the check box to enable this field.
	NOTE: Refer to your EtherNet/IP device user manual for class, instance and attribute values.	
	Number	The integer associated with the service to be performed by the explicit message. An integer from 1 to 127. NOTE: If you select Custom Service as the named service, type in a service number. This field is read-only for all other services.
	Name	Select the service the explicit message is intended to perform. In this example: Get_Attribute_Single .
	Enter Path	(Optional) Select this check box to enable the message path field, where you can manually enter the entire path to the target device. In this example, the path is not manually entered. NOTE: Displayed only when Advanced Mode is enabled.
	Data	The data to be sent to the target device, for services that send data. In this example, leave blank.
	Messaging	Select the type of explicit message to send: <ul style="list-style-type: none"> ● Connected ● Unconnected In this example, select Unconnected .
	Repeat 500 ms	Select this check box to re-send the explicit message every 500 ms. In this example, leave this blank.

Step	Action
4	After your explicit message is configured, click Send to Device . The Response area displays the data sent to the configuration tool by the target device in hexadecimal format. The Status area displays messages indicating whether or not the explicit message has succeeded.
5	Click Close to close the window.

Sending Explicit Messages to Modbus TCP Devices

Overview

Use the **Modbus Explicit Message** window to send an explicit message from Control Expert to a Modbus TCP module or device on the network.

You can use explicit messaging to perform many different services. Not all Modbus TCP devices support all services.

NOTE: Before you can perform explicit messaging, connect the DTM for the upstream communication module to the module itself. To do this, select the module node in the **DTM Browser**, then select **Edit** → **Connect**.

The **Modbus TCP Explicit Message** window, below, presents an example of both the configuration of a Modbus TCP explicit message, and the response. In this example, the explicit message is used to read 2 registers in the remote STB NIP 2212 network interface module, starting at offset 5391.

The screenshot displays the 'Modbus TCP Explicit Message' window with the following configuration and response:

Address	Service	Data
IP Address: 192 . 168 . 1 . 7	Number: 3	
Start Address: 5391	Name: ReadHoldingRegisters	
Quantity: 2		
Read Device Id Code: Basic Device Identity		
Object Id: 0		
Unit ID: 255		

Buttons: **Send to Device**, Repeat (500ms)

Response:
00 06 00 00 ;

Status:
Status = 0(0x0), description:ModbusNoError

Sending Explicit Messages

To send an explicit message to a target Modbus TCP device:

Step	Action																				
1	In the DTM Browser , select the communication module that is upstream of the target device.																				
2	Click the right mouse button, and in the pop-up menu select Device menu → Modbus Explicit Message . Result: The Modbus Explicit Message window opens.																				
3	<p>Configure the explicit message using the following fields:</p> <table border="1" style="width: 100%; border-collapse: collapse;"> <tr> <td style="width: 30%;">IP Address</td> <td>The IP address of the target device, used to identify the target of the explicit message. In this example: 192.168.1.7.</td> </tr> <tr> <td>Start Address</td> <td>A component of the addressing path. In this example 5391.</td> </tr> <tr> <td>Quantity</td> <td>A component of the addressing path. In this example 2.</td> </tr> <tr> <td>Read Device Id Code</td> <td>(read-only) The service the explicit message is intended to perform. In this example Basic Device Identity. Not used in this example.</td> </tr> <tr> <td>Object Id</td> <td>(read-only) Specify the object the explicit message is intended to access. In this example 0. Not used in this example.</td> </tr> <tr> <td colspan="2">Refer to your Modbus TCP device user manual for Start Address, Quantity, Read Device Id Code, and Object Id values.</td> </tr> <tr> <td>Unit Id</td> <td>The number of the device, or module, that is the target of the connection. A value of: <ul style="list-style-type: none"> ● 255 (the default) used to access the Ethernet communication module itself ● 0...254 identifies the device number of the target device, behind a Modbus TCP to Modbus gateway </td> </tr> <tr> <td>Number</td> <td>(read-only) The integer associated with the service to be performed by the explicit message. An integer from 0...255.</td> </tr> <tr> <td>Name</td> <td>Select the service the explicit message is intended to perform. In this example ReadHoldingRegisters</td> </tr> <tr> <td>Repeat 500ms</td> <td>Select this check box to re-send the explicit message every 500 ms. Leave this check box de-selected.</td> </tr> </table>	IP Address	The IP address of the target device, used to identify the target of the explicit message. In this example: 192.168.1.7 .	Start Address	A component of the addressing path. In this example 5391 .	Quantity	A component of the addressing path. In this example 2 .	Read Device Id Code	(read-only) The service the explicit message is intended to perform. In this example Basic Device Identity . Not used in this example.	Object Id	(read-only) Specify the object the explicit message is intended to access. In this example 0 . Not used in this example.	Refer to your Modbus TCP device user manual for Start Address, Quantity, Read Device Id Code, and Object Id values.		Unit Id	The number of the device, or module, that is the target of the connection. A value of: <ul style="list-style-type: none"> ● 255 (the default) used to access the Ethernet communication module itself ● 0...254 identifies the device number of the target device, behind a Modbus TCP to Modbus gateway 	Number	(read-only) The integer associated with the service to be performed by the explicit message. An integer from 0...255.	Name	Select the service the explicit message is intended to perform. In this example ReadHoldingRegisters	Repeat 500ms	Select this check box to re-send the explicit message every 500 ms. Leave this check box de-selected.
IP Address	The IP address of the target device, used to identify the target of the explicit message. In this example: 192.168.1.7 .																				
Start Address	A component of the addressing path. In this example 5391 .																				
Quantity	A component of the addressing path. In this example 2 .																				
Read Device Id Code	(read-only) The service the explicit message is intended to perform. In this example Basic Device Identity . Not used in this example.																				
Object Id	(read-only) Specify the object the explicit message is intended to access. In this example 0 . Not used in this example.																				
Refer to your Modbus TCP device user manual for Start Address, Quantity, Read Device Id Code, and Object Id values.																					
Unit Id	The number of the device, or module, that is the target of the connection. A value of: <ul style="list-style-type: none"> ● 255 (the default) used to access the Ethernet communication module itself ● 0...254 identifies the device number of the target device, behind a Modbus TCP to Modbus gateway 																				
Number	(read-only) The integer associated with the service to be performed by the explicit message. An integer from 0...255.																				
Name	Select the service the explicit message is intended to perform. In this example ReadHoldingRegisters																				
Repeat 500ms	Select this check box to re-send the explicit message every 500 ms. Leave this check box de-selected.																				
4	After your explicit message is configured, click Send to Device . The Response area displays any data sent to the configuration tool by the target device in hexadecimal format. The Status area displays messages indicating whether or not the explicit message has succeeded.																				
5	Click Close to close the window.																				

Chapter 9

Diagnostics

Overview

This chapter describes methods of diagnosing the condition of the Ethernet communication module provided by the:

- Ethernet communication module hardware, and
- Control Expert configuration software

What Is in This Chapter?

This chapter contains the following sections:

Section	Topic	Page
9.1	Module Hardware Diagnostics	326
9.2	Control Expert Software Diagnostics	328
9.3	CPU I/O Block Diagnostics	355

Section 9.1

Module Hardware Diagnostics

LED Indicators for the BMX NOC 0401

LED Indicators

The BMX NOC 0401 module displays the following indicators in the LED display area:



The module also displays the following LED indicators next to each Ethernet port connector:

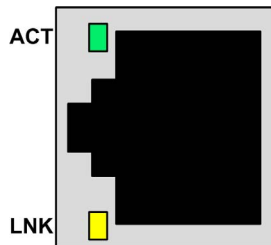

LED Descriptions

Use the LED display to diagnose the state of the module, as follows:

LED	Color	Description
RUN	Green	<ul style="list-style-type: none"> ● Off: Indicates that the module is not communicating with the CPU over the backplane. ● Steady Green: Indicates that the module: <ul style="list-style-type: none"> ○ has just been turned on and has not yet started the LED power-up test, or ○ is communicating with the CPU over the backplane
ERR	Red	<ul style="list-style-type: none"> ● Off: The module is operating normally. ● Blinking Red: The module is not configured (or the configuration is in progress), or backplane communication has stopped. ● Steady Red: The module has detected an event.
MS (Module Status)	Green/ Red	<ul style="list-style-type: none"> ● Off: Power is not being supplied to the module. ● Steady Green: The module is operating normally. ● Blinking Green: The module has not been configured. ● Steady Red: The module has detected a major event. ● Blinking Red: The module has detected a recoverable event.
NS (Network Status)	Green/ Red	<ul style="list-style-type: none"> ● Off: Power is not being supplied to the module, or the module has not been assigned an IP address. ● Steady Green: The module has established at least one CIP connection. ● Blinking Green: The module has obtained an IP address but has not established any CIP connections. ● Steady Red: The module has detected that its IP address is a duplicate IP address. ● Blinking Red: One or more CIP connection (with the module as target) have timed out.
ETH STS (Ethernet Status)	Amber	<ul style="list-style-type: none"> ● Off: No power is supplied to the module. ● Steady Amber: Indicates that the module is operating normally. ● Four flashes: The module has detected a duplicate IP address. ● Five flashes: The module is waiting for a served IP address. ● Six flashes: The module is using its default IP address. ● Seven flashes: The module has detected a configuration error. <p>NOTE: If more than one diagnostic condition exists simultaneously, the Ready LED displays the shortest flash sequence.</p>
LNK (Link)	Yellow/ Green	<ul style="list-style-type: none"> ● Off: An Ethernet link has not been established. ● Yellow: A 10 Mbit Ethernet link has been established ● Green: A 100 Mbit Ethernet link has been established
ACT (Activity)	Green	<ul style="list-style-type: none"> ● Off: There is no receive or transmit activity. ● Flashes Green: Indicates activity.

Section 9.2

Control Expert Software Diagnostics

Overview

This section describes the diagnostic tools, provided by the Control Expert configuration software, that you can use to monitor the condition of the Ethernet communication module.

What Is in This Section?

This section contains the following topics:

Topic	Page
Using the Diagnostic Window	329
Ethernet Port Diagnostics	332
Bandwidth Diagnostics	336
Email Diagnostics	339
Network Time Service Diagnostics	341
Communication Module RSTP Diagnostics	344
Local Slave / Connection Diagnostics	347
Local Slave or Connection I/O Value Diagnostics	351
Logging	353

Using the Diagnostic Window

Introduction

Use the **Diagnostic** window to display:

- LED icons (in the left pane of the window) that indicate the operating status of modules, devices and connections
- pages (in the right pane of the window) that present diagnostic data for the following:
 - the communication module
 - local slave nodes activated for the communication module
 - EtherNet/IP connections between the communication module and a remote EtherNet/IP device

NOTE: Before you can open the **Diagnostic** window, connect the DTM for the target communication module to the physical module itself. To do this, select the module node in the **DTM Browser**, then select **Edit** → **Connect**.

The **Diagnostic** window looks like this:

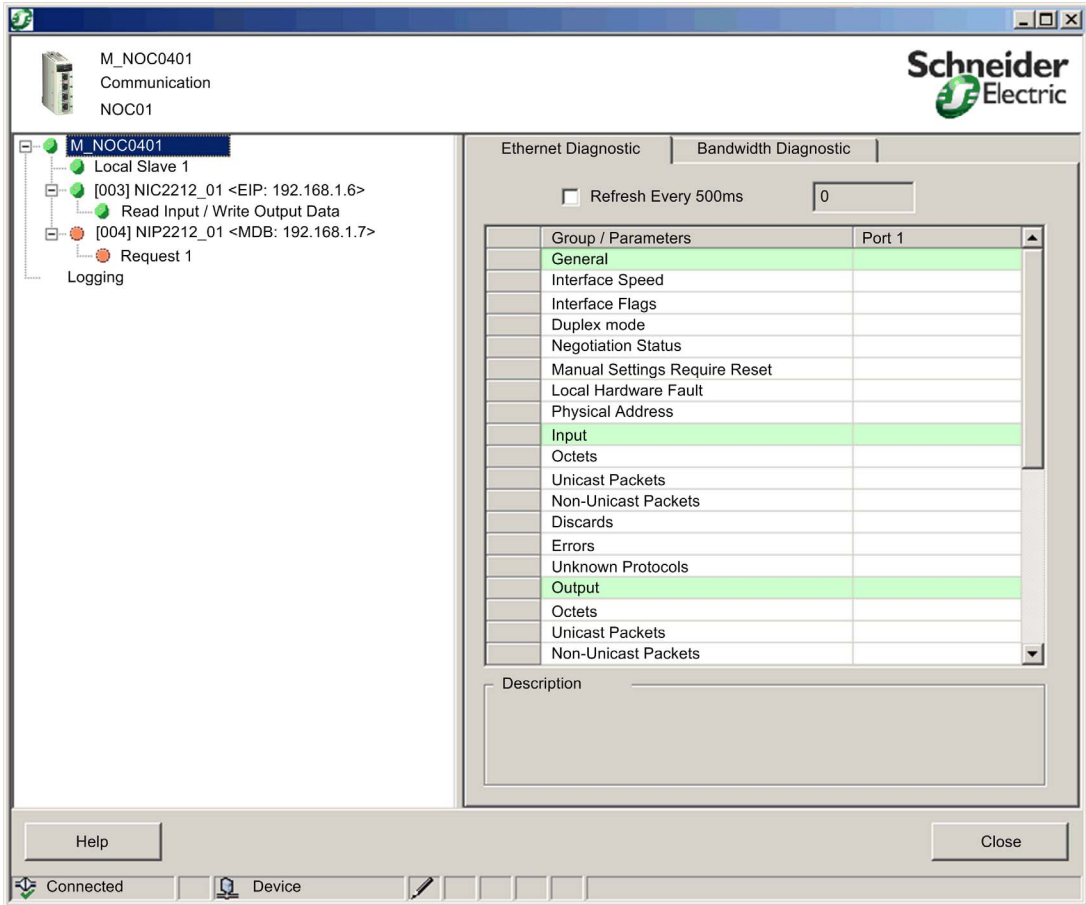



To open the **Diagnostic** window:

Step	Action
1	In the DTM Browser , select the communication module and click the right mouse button. A pop-up menu opens.
2	In the menu, select Device menu → Diagnostic .

Diagnostic LED Icons

During the time that a communication module DTM is connected to the physical communication module, Control Expert sends an explicit message request once per second to detect the state of the communication module and the states of the remote devices and EtherNet/IP connections linked to that module.

Control Expert places one of the following status icons over the module, device or connection nodes in the left pane of the **Diagnostic** window to indicate its current status:

This icon...	Indicates the following state for a...	
	Communication module	Connection to a remote device
	Run state	The health bit for every EtherNet/IP connection and Modbus TCP request, to a remote device or to a sub-device or module, is set to active (1).
	One of the following: <ul style="list-style-type: none"> ● unknown ● started ● stopped ● not connected 	The health bit for at least one EtherNet/IP connection or Modbus TCP request, to a remote device or to a sub-device or module, is set to inactive (0).

Ethernet Port Diagnostics

Introduction

Use the **Ethernet Diagnostic** page to display either dynamically generated or static data for the communication module's Ethernet port(s). The page displays five columns of data, as follows:

- one column for an module's Internal Port, and
- up to four columns for the enabled external Ethernet ports (ports 1, 2, 3 and 4)

Use the **Refresh Every 500ms** checkbox to display static or dynamic data, as follows:

When the checkbox is...	This page...
Selected	<ul style="list-style-type: none">● Displays data that is dynamically updated every 500 ms, and● Increments the number at the top of the table each time data is refreshed
De-selected	<ul style="list-style-type: none">● Displays static data, and● Does not Increment the number at the top of the table, which instead displays a constant value

NOTE: Before you can open the **Diagnostic** window, connect the DTM for the target communication module to the physical module itself. To do this, select the module node in the **DTM Browser**, then select **Edit → Connect**.

The **Ethernet Diagnostic** page looks like this:

Ethernet Diagnostic | Bandwidth Diagnostic

Refresh Every 500ms | 112

Group / Parameters	Port 1	Port 2	Port 3	Port 4	Internal Port
General					
Interface Speed	100	100	100	100	100
Interface Flags	Active link	Active link	Inactive link	Inactive link	Active link
Duplex mode	Full duplex	Full duplex	Indetermined	Indetermined	Full duplex
Negotiation Status	Successfully n	Successfully n	Auto-negotiat	Auto-negotia	Successfully n
Manual Settings Require Reset	Interface can a	Interface can a	Interface can a	Interface ca	Interface can
Local Hardware Fault	No	No	No	No	No
Physical Address	08-80-F4-01-FC	08-80-F4-01-F	08-80-F4-01-F	08-80-F4-01-	08-80-F4-01-
Input					
Octets	11620142	17820149	24183465	23657898	6687904
Unicast Packets	52909	72907	654879	8994	546756
Non-Unicast Packets	103124	33	36	37180	658112
Discards	0	0	3680	0	0
Errors	0	0	0	0	0
Unknown Protocols	0	0	0	0	0
Output					
Octets	41311209	5467812	6454123	4131129	7181139
Unicast Packets	53514	67345	75698	96123	73575
Non-Unicast Packets	40	125	215	23546	3122

Description

To open this page:

Step	Action
1	In the DTM Browser , select the communication module and click the right mouse button. A pop-up menu opens.
2	In the menu, select Device menu → Diagnostic .
3	In the left pane of the Diagnostic window, select the communication module node.
4	Click on the Ethernet Diagnostic tab to open that page.

Ethernet Diagnostic Parameters

The **Ethernet Diagnostic** page displays the following parameters for each communication module port:

Parameter	Description
General parameters:	
Interface Speed	Valid values include: 0, 10, 100 Mbits/second
Interface Flags	Bit 0—Link Status: 0 = Inactive; 1 = Active
	Bit 1—Duplex Mode (see below)
	Bits 2...4—Negotiation Status (see below)
	Bit 5—Manual Setting Requires Reset (see below)
	Bit 6—Local Hardware Fault detected (see below)
Duplex Mode	0 = half duplex; 1 = full duplex
Negotiation Status	3 = successfully negotiated speed and duplex 4 = forced speed and link
Manual Setting Requires Reset	0 = automatic; 1 = device requires reset
Local Hardware Fault	0 = no event; 1 = event detected
Physical Address	Module MAC Address
Input parameters:	
Octets	Octets received on the interface
Unicast Packets	Unicast packets received on the interface
Non-Unicast Packets	Non-unicast packets received on the interface
Discards	Inbound packets received on the interface, but discarded
Errors	Inbound packets that contain detected errors (does not include In Discards)
Unknown Protocols	Inbound packets with unknown protocol
Output parameters:	
Octets	Octets received on the interface
Unicast Packets	Unicast packets received on the interface
Non-Unicast Packets	Non-unicast packets received on the interface
Discards	Inbound packets received on the interface, but discarded
Errors	Outbound packets that contain detected errors (does not include In Discards)
Unknown Protocols	Outbound packets with unknown protocol
Error counter parameters:	
Alignment Errors	Frames that are not an integral number of octets in length
FCS Errors	Frames received with a detected FCS checksum error
Single Collisions	Successfully transmitted frames that experienced exactly one collision

Parameter	Description
Multiple Collisions	Successfully transmitted frames that experienced more than one collision
SQE Test Errors	Number of times the SQE test error is detected
Deferred Transmissions	Frames for which first transmission attempt is delayed because the medium is busy
Late Collisions	Number of times a collision is detected later than 512 bittimes into the transmission of a packet
Excessive Collisions	Frames for which transmission is not successful due to excessive collisions
MAC Transmit Errors	Frames for which transmission is not successful due to internal MAC sublayer transmit error
Carrier Sense Errors	Times that the carrier sense condition was lost or not asserted when attempting to transmit a frame
Frame Too Long	Frames received that exceed the maximum permitted frame size
MAC Receive Errors	Frames for which reception on an interface is not successful due to an internal MAC sublayer receive detected error

Bandwidth Diagnostics

Introduction

Use the **Bandwidth Diagnostic** page to display either dynamically generated or static data for the communication module's bandwidth usage.

Use the **Refresh Every 500ms** checkbox to display static or dynamic data, as follows:

When the checkbox is...	This page...
Selected	<ul style="list-style-type: none"> Displays data that is dynamically updated every 500 ms, and Increments the number at the top of the table each time data is refreshed
De-selected	<ul style="list-style-type: none"> Displays static data, and Does not increment the number at the top of the table, which instead displays a constant value

NOTE: Before you can open the **Diagnostic** window, connect the DTM for the target communication module to the physical module itself. To do this, select the module node in the **DTM Browser**, then select **Edit → Connect**.

The **Bandwidth Diagnostic** page looks like this:

The screenshot shows the 'Bandwidth Diagnostic' page with the 'Refresh Every 500ms' checkbox checked and a refresh interval of 112. The table below displays the data shown in the interface.

Group / Parameter	Value	Unit
I/O - Scanner		
EtherNet/IP Sent	0	Packets/s
EtherNet/IP Received	0	Packets/s
Modbus/TCP Sent	16	Packets/s
Modbus/TCP Received	16	Packets/s
I/O - Adapter		
EtherNet/IP Sent	0	Packets/s
EtherNet/IP Received	0	Packets/s
I/O - Module		
Module Capacity	12000	Packets/s
Module Utilization	0	%
Messaging - Client		
EtherNet/IP Activity	0	Packets/s
Modbus/TCP Activity	0	Packets/s
Messaging - Server		
EtherNet/IP Activity	7	Packets/s
Modbus/TCP Activity	1	Packets/s
Module		
Processor Utilization	14	%

Below the table is a 'Description' field, which is currently empty.

To open this page:

Step	Action
1	In the DTM Browser , select the communication module and click the right mouse button. A pop-up menu opens.
2	In the menu, select Device menu → Diagnostic . The Diagnostic window opens.
3	In the left pane of the Diagnostic window, select the communication module node.
4	Click on the Bandwidth Diagnostic tab to open that page.

Bandwidth Diagnostic Parameters

The **Bandwidth Diagnostic** page displays the following parameters for the communication module:

Parameter	Description
I/O - Scanner:	
EtherNet/IP Sent	The number of EtherNet/IP packets the module has sent, since the last reset, in packets/second.
EtherNet/IP Received	The number of EtherNet/IP packets the module has received, since the last reset, in packets/second.
Modbus TCP Requests	The number of Modbus TCP requests the module has sent, since the last reset, in packets/second.
Modbus TCP Responses	The number of Modbus TCP responses the module has received, since the last reset, in packets/second.
I/O - Adapter:	
EtherNet/IP Sent	The number of EtherNet/IP packets the module has sent—in the role of a local slave—since the last reset, in packets/second.
EtherNet/IP Received	The number of EtherNet/IP packets the module has received—in the role of a local slave—since the last reset, in packets/second.
I/O - Module	
Module Capacity	The maximum number of packets that the module can process, in packets per second.
Module Utilization	The percentage of communication module capacity being used by the application.
Messaging - Client:	
EtherNet/IP Activity	The number of I/O messages sent by the module—using the EtherNet/IP protocol—since last reset, in packets per second.
Modbus TCP Activity	The number of I/O messages sent by the module—using the Modbus TCP protocol—since last reset, in packets per second.

Parameter	Description
Messaging - Server:	
EtherNet/IP Activity	The number of I/O messages received by the module—using the EtherNet/IP protocol—since last reset, in packets per second.
Modbus TCP Activity	The number of I/O messages received by the module—using the Modbus TCP protocol—since last reset, in packets per second.
Module:	
Processor Utilization	The percent of Ethernet communication module processor capacity used by the present level of communication activity.

Email Diagnostics

Diagnosing SMTP Transmissions

Use the **Email Diagnostic** page to display dynamically generated data describing the communication module's Email message transmissions.

NOTE: Before you can open the **Diagnostic** window, connect the DTM for the target communication module to the physical module itself. To do this, select the module node in the **DTM Browser**, then select **Edit** → **Connect**.

The **Email Diagnostic** page looks like this:

The screenshot shows the 'Email Diagnostic' page with the following elements:

- Navigation tabs: Ethernet Diagnostic, Bandwidth Diagnostic, RSTP Diagnostic, **Email Diagnostic**, Network Time Service Diagnostic.
- Refresh Every 500ms: (checked), 192
- Email Service: (green checkmark)
- Remote Email Server Status: (green checkmark)
- SMTP Server IP Address: 192 . 168 . 1 . 10
- Last Email Header Used:
 - Sender: operator1@company.com
 - Receivers: merle@mainoffice.com
 - Subject: Pump#1 pumping mud, Merle, shut her down
- Number of Emails Sent: 2
- Number of Errors: 0
- Time Since Last Email: 280 Secs
- Email Server Not Reachable: 0 Times
- Last Error: 16#5104
- Reset Counter button

Click the **Reset Counter** button to reset the counting statistics on this page to 0.

To open this page:

Step	Action
1	In the DTM Browser , select the communication module and click the right mouse button. A pop-up menu opens.
2	In the menu, select Device menu → Diagnostic . The Diagnostic window opens.
3	In the left pane of the Diagnostic window, select the communication module node.
4	Click on the Email Diagnostic tab to open that page.

Email diagnostic Parameters

Email service parameters include the following:

Parameter	Description
Refresh Every 500ms	Select this to dynamically update this page every 500ms. The number of times this page has been refreshed appears immediately to the right (in this example, 192).
Email Service	The status of this service in the Ethernet communication module: <ul style="list-style-type: none"> ● green = operational (OK) ● orange = not operational (NOK)
Remote Email Server Status	The connection status between Ethernet communication module and the SMTP server: <ul style="list-style-type: none"> ● green = operational (OK) ● red = not operational (NOK) <p>NOTE: Status is checked at start-up and at least every 30 minutes after start-up.</p>
SMTP Server IP Address	IP address of the SMTP server
Sender	The three header fields of the last Email message sent.
Receivers	
Subject	
Number of Emails Sent	Total number of emails sent and successfully acknowledged by the SMTP server.
Time Since Last Email	Counts the number of seconds since the last email was successfully sent.
Last Error	Hexadecimal code describing the reason for the last unsuccessful Email transmission (<i>see page 433</i>). The value "0" indicates no unsuccessful transmissions.
Time Since Last Email	Counts the number of seconds since the last email was successfully sent.
Number of Errors	Total number of emails that either: <ul style="list-style-type: none"> ● could not be sent ● were sent but were not successfully acknowledged by the SMTP server
Email Service Not Reachable	Number of times the SMTP server could not be reached. (Link checked every 30 minutes.)

Network Time Service Diagnostics

Diagnosing the Network Time Service

Use the **Network Time Service Diagnostic** page to display dynamically generated data describing the operation of the network time protocol (NTP) service that you configured in the Network Time Service page (*see page 105*) in Control Expert.

NOTE: Before you can open the **Diagnostic** window, connect the DTM for the target communication module to the physical module itself. To do this, select the module node in the **DTM Browser**, then select **Edit** → **Connect**.

The **Network Time Service Diagnostic** page looks like this:

The screenshot displays the 'Network Time Service Diagnostic' page with the following fields and values:

- Refresh Every 500ms:** 785
- Status:**
 - Network Time Service: ● Last Update: 11.7 Seconds
 - Network Time Server Status: ●
 - Current Date: 21-Oct-2011 Current Time: 14:27:53
 - DST Status: ON Quality: 0 Microseconds/Second
 - Requests: 0 Responses: 0
 - Errors: 0 Last Error: 16#0 Reset Counter
- Server Information:**
 - Primary NTP Server IP: 192 . 168 . 1 . 1 ●
 - Secondary NTP Server IP: 192 . 168 . 1 . 2 Polling Period: 20 Seconds
- Daylight Saving Settings:**
 - DST Start: Month: March Day of Week: Sunday Week#: 1
 - DST End: Month: March Day of Week: Sunday Week#: 1
 - Time Zone: (GMT) Greenwich Mean Time (Dublin Edinburgh Lisbon London)
 - Offset: 360 Mins Auto Adjust Clock for Daylight Savings: Enabled

Click the **Reset Counter** button to reset the counting statistics on this page to 0.

To open this page:

Step	Action
1	In the DTM Browser , select the communication module and click the right mouse button. A pop-up menu opens.
2	In the menu, select Device menu → Diagnostic . The Diagnostic window opens.
3	In the left pane of the Diagnostic window, select the communication module node.
4	Click on the NTP Diagnostic tab to open that page.

Network Time Service Diagnostic Parameters

Time synchronization service parameters are in the table:

Parameter	Description
Refresh Every 500ms	Select this to dynamically update this page every 500ms. The number of times this page has been refreshed appears immediately to the right (in this example, 785).
Network Time Service	Operational status of the service in the module: <ul style="list-style-type: none"> ● green = operational ● orange = not operational
Network Time Server Status	Communication status of the NTP server: <ul style="list-style-type: none"> ● green = the NTP server is reachable ● red = the NTP server is not reachable
Last Update	Elapsed time, in seconds, since the most recent NTP server update.
Current Date	System date
Current Time	System time in hh:mm:ss format
DST Status	The actual working status of the automatic daylight savings service: <ul style="list-style-type: none"> ● ON = automatic adjustment of daylight savings is enabled and the current date and time reflect the daylight savings time adjustment ● OFF = automatic adjustment of daylight savings is disabled; or automatic adjustment of daylight savings is enabled, but the current date and time may not reflect the daylight savings time adjustment
Quality	The correction, in seconds, applied to the local counter at every NTP server update. Numbers greater than 0 indicate increasingly excessive traffic condition or NTP server overload.
Requests	Total number of client requests sent to the NTP server
Responses	Total number of server responses sent from the NTP server
Errors	Total number of unanswered NTP requests

Parameter	Description	
Last Error	<p>Last detected error code received from the NTP client:</p> <ul style="list-style-type: none"> ● 0: good NTP configuration ● 1: late NTP server response (can be caused by excessive network traffic or server overload) ● 2: NTP not configured ● 3: invalid NTP parameter setting ● 4: NTP component disabled ● 7: unrecoverable NTP transmission ● 9: invalid NTP server IP address ● 15: invalid syntax in the custom time zone rules file 	
Primary / Secondary NTP Server IP	<p>The IP address of the primary and the secondary NTP server</p> <p>NOTE: A green LED to the right of the primary or secondary NTP server IP address identifies the currently active server.</p>	
Auto Adjust Clock for Daylight Savings	<p>The configuration setting of the daylight savings adjustment service:</p> <ul style="list-style-type: none"> ● enabled ● disabled 	
DST Start / DST End	Specifies the day that daylight savings time begins and ends:	
	Month	The month daylight savings time starts or ends
	Day of Week	The day of the week daylight savings time starts or ends
	Week#	The occurrence of the specified day within the specified month.
Time Zone	Time zone plus or minus Universal Time, Coordinated (UTC)	
Offset	The time, in minutes, to be combined with the selected Time Zone selection to produce the system time.	
Polling Period	The frequency the NTP client requests time updates from the NTP server	

Communication Module RSTP Diagnostics

Introduction

Use the **RSTP Diagnostic** page to display either dynamically generated or static data for a BMX NOC 0401 (M340) communication module's RSTP service.

Use the **Refresh Every 500ms** checkbox to display static or dynamic data, as follows:

When the checkbox is...	This page...
Selected	<ul style="list-style-type: none">• Displays data that is dynamically updated every 500 ms, and• Increments the number at the top of the table each time data is refreshed
De-selected	<ul style="list-style-type: none">• Displays static data, and• Does not Increment the number at the top of the table, which instead displays a constant value

NOTE: Before you can open the **Diagnostic** window, connect the DTM for the target communication module to the physical module. To do this, select the module node in the **DTM Browser**, then select **Edit → Connect**.

The **RSTP Diagnostic** page looks like this:

The screenshot shows the RSTP Diagnostic page with three tabs: Ethernet Diagnostic, Bandwidth Diagnostic, and RSTP Diagnostic. The RSTP Diagnostic tab is active. At the top, there is a checkbox for 'Refresh Every 500ms' which is checked, and a text input field containing the number '55'. Below this is a table with three columns: 'Group / Parameter', 'Value', and 'Unit'. The table is divided into several sections, some of which are highlighted in green. The sections are: Bridge RSTP Diagnostic, Port 3 RSTP Statistics, and another Port 3 RSTP Statistics section. Below the table is a 'Description' text area.

Group / Parameter	Value	Unit
Bridge RSTP Diagnostic		
Bridge ID	0	
MAC Address	00-00-00-00-00-00	
Designated Root ID	0	
Root Path Cost	0	
Default Hello Time	2	sec
Learned Hello Time	0	sec
Configured Max Age	40	sec
Learned Max Age	0	sec
Total Topology Changes	0	
Port 3 RSTP Statistics		
Status	Disabled	
Role	Unknown (0)	
Cost	0	
STP Packets	0	
Port 3 RSTP Statistics		
Status	Disabled	
Role	Unknown (0)	
Cost	0	

Description

To open this page:

Step	Action
1	In the DTM Browser , select the communication module and click the right mouse button. A pop-up menu opens.
2	In the menu, select Device menu → Diagnostic .
3	In the left pane of the Diagnostic window, select the communication module node.
4	Click on the RSTP Diagnostic tab to open that page.

RSTP Diagnostic Parameters

The **RSTP Diagnostic** page displays the following parameters for each communication module port:

Parameter	Description
Bridge RSTP Diagnostic:	
Bridge ID	An 8-byte bridge identification field is comprised of a 2 sub-fields: <ul style="list-style-type: none"> • Bridge Priority: a 2-byte value from 0 to 65535—with a default of 32768—assigned to the module's embedded Ethernet switch • MAC Address (see below)
MAC Address	The Media Access Control address of a device, found on the front of the module.
Designated Root ID	The Bridge ID of the root switch.
Root Path Cost	The aggregate cost of port costs from this switch back to the root switch.
Default Hello Time	The interval at which Configuration BPDU messages will be transmitted during a network convergence. For RSTP this is a fixed value of 2 seconds.
Learned Hello Time	The current Hello Time value learned from the root switch.
Configured Max Age	The value that other switches use for MaxAge when this switch is acting as the root. Valid range: 6 to 40
Learned Max Age	The maximum age learned from the root switch. This is the actual value currently used by this switch.
Total Topology Changes	The total number of topology changes detected by this switch since the management entity was last reset or initialized.
Ports 3 and 4 RSTP Statistics:	
Status	The port's current state as defined by RSTP Protocol. This state controls the action the port takes when it receives a frame. Possible values are: disabled, discarding, learning, forwarding.
Role:	The port's current role per RSTP protocol. Possible values are: root port, designated port, alternate port, backup port, disabled port.
Cost	The logical cost of this port as a path to the root switch. If this port is configured for AUTO then the cost is determined based on the connection speed of the port.
STP Packets	A value in this field indicates that a device on the network has the STP protocol enabled. <p>NOTE:</p> <ul style="list-style-type: none"> • Other devices, with STP enabled, can severely affect the network convergence times. Schneider Electric recommends the STP protocol (but not the RSTP protocol) be disabled on every network device capable of supporting it. • The communication module does not support the STP protocol. The module's embedded switch ignores ignore STP packets.

Local Slave / Connection Diagnostics

Introduction

The **Local Slave Diagnostic** page and the **EIP Connection Diagnostic** page present common information. Use the:

- **Local Slave Diagnostic** page to display I/O status and production/consumption information for a selected local slave
- **EIP Connection Diagnostic** page to display I/O status and production/consumption information for a connection of a remote EtherNet/IP device

Use the **Refresh Every 500ms** checkbox to display static or dynamic data, as follows:

When the checkbox is...	This page...
Selected	<ul style="list-style-type: none"> ● Displays data that is dynamically updated every 500 ms, and ● Increments the number at the top of the table each time data is refreshed
De-selected	<ul style="list-style-type: none"> ● Displays static data, and ● Does not Increment the number at the top of the table, which instead displays a constant value

NOTE: Before you can open the **Diagnostic** window, connect the communication module or remote device DTM to the physical module or device. To do this, select the appropriate node in the **DTM Browser**, then select **Edit** → **Connect**.

The following figure presents an example of the **EIP Connection Diagnostic** page. (Except for the title, the **Local Slave Diagnostic** page is the same.)

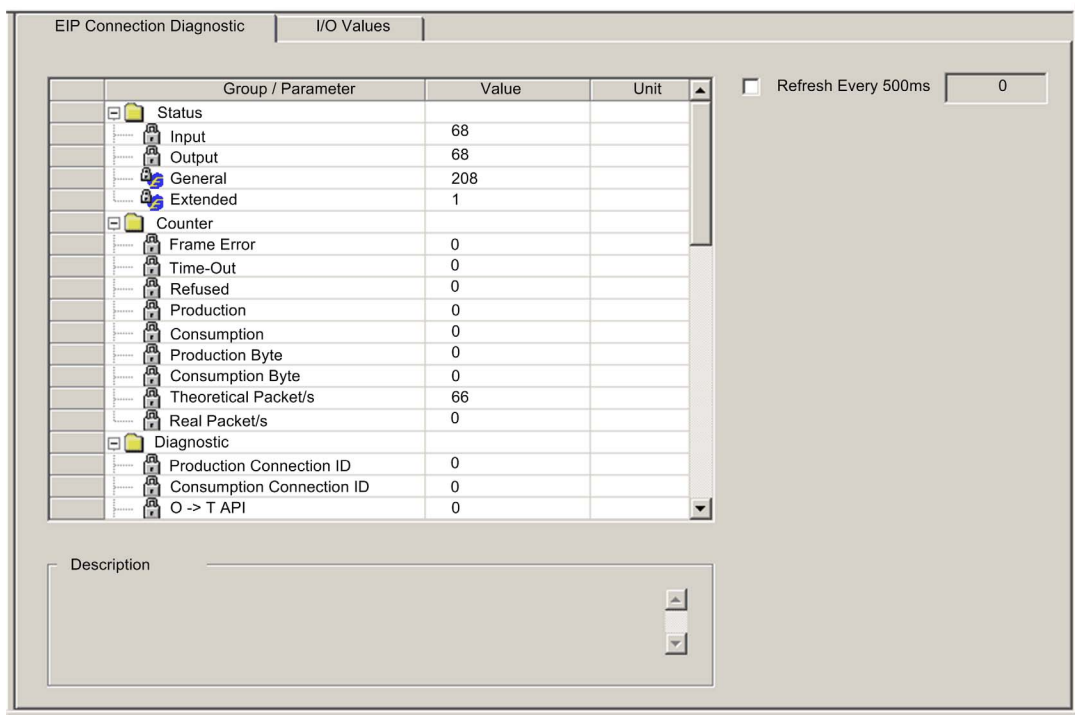

To open this page:

Step	Action
1	In the DTM Browser , select the communication module and click the right mouse button. A pop-up menu opens.
2	In the menu, select Device menu → Diagnostic .
3	In the left pane of the Diagnostic window, click on one of the following: <ul style="list-style-type: none"> ● for local slave diagnostics, select the communication module node ● for remote device connection diagnostics, select a remote device connection
4	Depending upon you selection in step 3, above, click on either the Local Slave Diagnostic tab or the EIP Connection Diagnostic tab to open that page.

Diagnostic Parameters

This page displays the following diagnostic parameters for the selected local slave or connection:

Parameter	Description
Status (<i>see page 350</i>):	
Input	An integer representing input status.
Output	An integer representing output status.
General	An integer representing basic connection status.
Extended	An integer representing extended connection status.
Counter:	
Frame Error	Increments each time a frame is not sent by missing resources or is impossible to send.
Time-Out	Increments each time a connection times out.
Refused	Increments when connection is refused by the remote station.
Production	Increments each time a message is produced.
Consumption	Increments each time a message is consumed.
Production Byte	Total of produced messages, in bytes, since the communication module was last reset.
Consumption Byte	Total of consumed messages, in bytes, since the communication module was last reset.
Theoretical Packets per second	Packets per second calculated using current configuration value.
Real Packets per second	Actual number of packets per second generated by this connection.
Diagnostic:	
Production Connection ID	The connection ID.
Consumption Connection ID	The connection ID.
O -> T API	Accepted packet interval (API) of the output connection.
T -> O API	Accepted packet interval (API) of the input connection.
O -> T RPI	Requested packet interval (RPI) of the output connection.
T -> O RPI	Requested packet interval (RPI) of the input connection.
Socket Diagnostics:	
Socket ID	Internal Identification of the socket.
Remote IP Address	IP address of the remote station, for this connection.
Remote Port	Port number of the remote station, for this connection.
Local IP Address	IP address of the communication module, for this connection.
Local Port	Port number of the communication module, for this connection.

Connection Status Codes

The Input and Output Status diagnostic parameters (*see page 349*), in the preceding table, can present the following values:

Input/Output Status (dec)	Description
0	OK
33	Time-out
53	IDLE
54	Connection established
58	Not connected (TCP)
65	Not connected (CIP)
68	Connection establishing
70	Not connected (EPIC)
77	Scanner stopped

Local Slave or Connection I/O Value Diagnostics

Introduction

Use the **I/O Values** page to display both the input data image and output data image for the selected local slave or connection.

Use the **Refresh Every 500ms** checkbox to display static or dynamic data, as follows:

When the checkbox is...	This page...
Selected	<ul style="list-style-type: none"> • Displays data that is dynamically updated every 500 ms, and • Increments the number at the top of the table each time data is refreshed
De-selected	<ul style="list-style-type: none"> • Displays static data, and • Does not Increment the number at the top of the table, which instead displays a constant value

NOTE: Before you can open the **Diagnostic** window, connect the communication module or remote device DTM to the physical module or device. To do this, select the appropriate node in the **DTM Browser**, then select **Edit → Connect**.

To open this page:

Step	Action
1	In the DTM Browser , select the communication module and click the right mouse button. A pop-up menu opens.
2	In the menu, select Device menu → Diagnostic .
3	In the left pane of the Diagnostic window, click on one of the following: <ul style="list-style-type: none"> • the communication module node, or • a connection node
4	Click on the I/O Values tab to open that page.

The following example depicts the **I/O Values** page for a remote device connection:

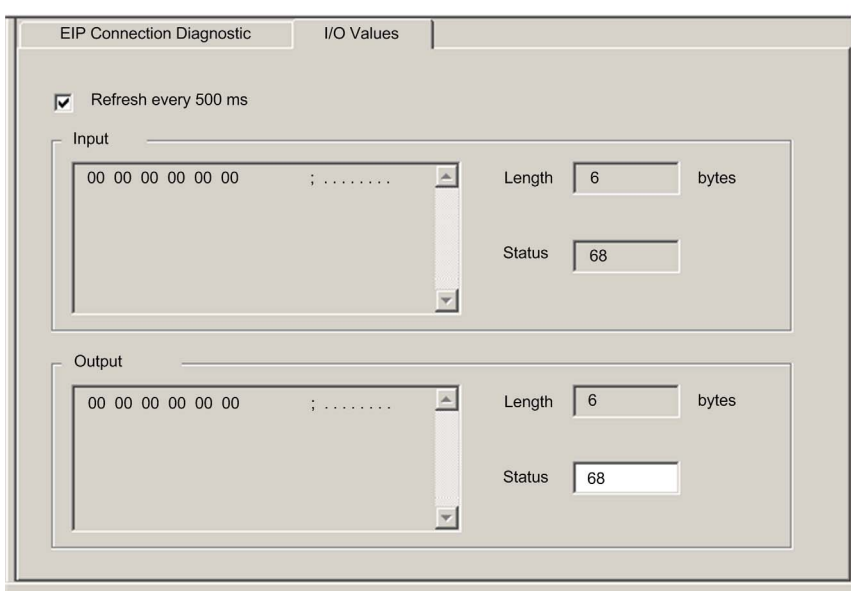

Local Slave / Connection I/O Values

This page displays the following parameters for either a local slave or a remote device connection input and output values:

Parameter	Description
Input/Output data display	A display of the local slave or remote device input or output data image.
Length	The number of bytes in the input or output data image.
Status	The Scanner Diagnostic object's scanner status (<i>see page 265</i>), with respect to the read of the input or output data image.

Logging

Description

Control Expert maintains a log of events for:

- the Control Expert embedded FDT container
- each Ethernet communication module DTM, and
- each EtherNet/IP remote device DTM

Events relating to the Control Expert FDT container are displayed in the **FDT log event** page of the **Output Window**.

Events relating to a communication module or remote EtherNet/IP device are displayed:

- in configuration mode: in the **Device Editor**, by selecting the **Logging** node in the left pane
- in diagnostic mode: in the **Diagnostics** window, by selecting the **Logging** node in the left pane

The following is a sample of the events log displayed in the **Diagnostics** window:

Date / Time	Log Level	Message	Detail Message
2009-09-25 08:57:23	Error	Communication error occurred.	Unknown status!
2009-09-25 08:56:45	Information	The FDT Frame Application has ...	
2009-09-25 08:55:14	Information	IP Address of slave device succe...	192.168.1.1 -> 192...
2009-09-25 08:52:56	Information	The FDT Frame Application has ...	
2009-09-25 08:52:17	Information	DTM is offline.	
2009-09-25 08:50:44	Information	DTM is offline.	
2009-09-25 08:49:12	Information	The FDT Frame Application has ...	
2009-09-25 08:48:52	Information	The FDT Frame Application has ...	
2009-09-25 08:46:56	Information	The FDT Frame Application has ...	
2009-09-25 08:45:17	Warning	The persisted network interface c...	
2009-09-25 08:43:44	Information	DTM is offline.	
2009-09-25 08:42:12	Information	The FDT Frame Application has ...	
2009-09-25 08:40:52	Information	The FDT Frame Application has ...	

Logging Attributes

The **Logging** window displays the result of an operation or function performed by Control Expert. Each log entry includes the following attributes:

Attribute	Description	
Date/Time	The time the event occurred, displayed in the format: yyyy-mm--dd hh:mm:ss	
Log Level	The level of event importance. Values include:	
	Information	A successfully completed operation.
	Warning	An operation that Control Expert completed, but which may lead to a subsequent detected error.
	Error	An operation that Control Expert was unable to complete.
Message	A brief description of the core meaning of the event.	
Detail Message	A more detailed description of the event, which may include parameter names, location paths, etc.	

Section 9.3

CPU I/O Block Diagnostics

Overview

The CPU's I/O Block contains diagnostic information relating to the operation of the BMX NOC 0401 Ethernet communication module. This information can be accessed in Control Expert at runtime. This section describes the available I/O Block data, and how to access it.

What Is in This Section?

This section contains the following topics:

Topic	Page
Accessing the Control Expert Diagnostic Tools	356
Communication Channel Diagnostics in Control Expert	358
Communication Module Diagnostics in Control Expert	360

Accessing the Control Expert Diagnostic Tools

Overview

The Control Expert software provides diagnostic tools that let you view the:

- communication module status
- communication module's:
 - detected faults
 - I/O objects
- communication channel's:
 - MAC Address
 - IP Address settings
 - detected faults

These Control Expert diagnostic tools are available in the BMX NOC 0401 **Module Properties** window, only when Control Expert is operating online.

NOTE: If the module and software are disconnected, use the Master DTM diagnostic screen in Control Expert to check the I/O status.

Accessing Control Expert Diagnostic Tools

To access diagnostic tools for the Ethernet communication module:

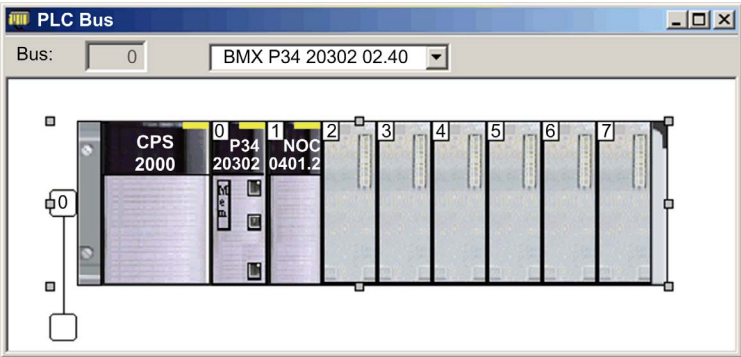
Step	Action
1	<p>Open the Control Expert project backplane diagram, below:</p>  <p>The screenshot shows a window titled 'PLC Bus' with a dropdown menu set to 'Bus: 0' and another dropdown set to 'BMX P34 20302 02.40'. Below the dropdowns is a backplane diagram with eight slots numbered 0 to 7. Slot 0 contains a 'CPS 2000' module. Slot 1 contains a 'P34 20302' module. Slot 2 contains a 'NOC 0401.2' module. Slots 3 through 7 are empty.</p>

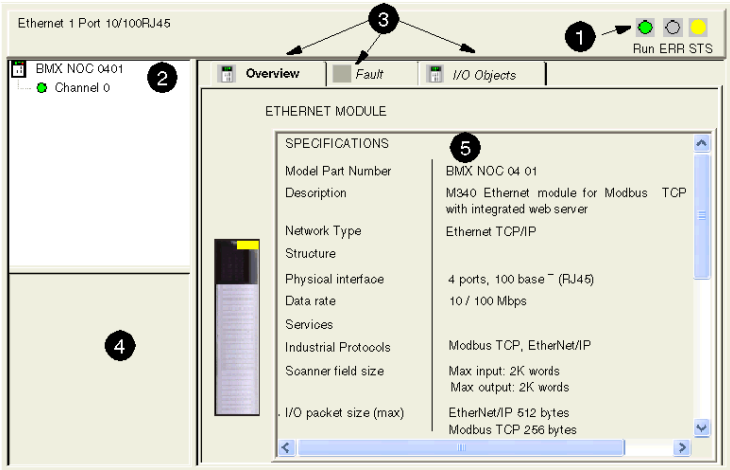
Step	Action										
2	<p>Do one of the following:</p> <ul style="list-style-type: none"> ● double click the left mouse button on the communication module in the window above, or ● click the right mouse button on the communication module, then select Open Module... in the popup menu <p>The Ethernet Module window opens:</p> 										
3	<p>Navigate the Ethernet Module window using the following features:</p> <table border="1" data-bbox="356 893 1251 1481"> <tbody> <tr> <td data-bbox="356 893 637 958">1 Module status icons</td> <td data-bbox="637 893 1251 958">These three indicators display the module's status in online mode.</td> </tr> <tr> <td data-bbox="356 958 637 1047">2 Channel area</td> <td data-bbox="637 958 1251 1047">Select a node to display parameters for either: <ul style="list-style-type: none"> ● the communication module, or ● a communication channel </td> </tr> <tr> <td data-bbox="356 1047 637 1323">3 Page tabs</td> <td data-bbox="637 1047 1251 1323">Select a page to display module or channel properties: <ul style="list-style-type: none"> ● for the communication module: <ul style="list-style-type: none"> ○ Overview ○ Fault ○ I/O Objects ● for a communication channel: <ul style="list-style-type: none"> ○ Configuration ○ Debug ○ Fault </td> </tr> <tr> <td data-bbox="356 1323 637 1445">4 General parameters</td> <td data-bbox="637 1323 1251 1445">View communication channel parameters: <ul style="list-style-type: none"> ● Function displays the configured communication function and is read-only. ● Task displays the task (configured MAST) and is read-only. </td> </tr> <tr> <td data-bbox="356 1445 637 1481">5 Mode parameters</td> <td data-bbox="637 1445 1251 1481">Displays parameters for the mode you select by opening a page.</td> </tr> </tbody> </table>	1 Module status icons	These three indicators display the module's status in online mode.	2 Channel area	Select a node to display parameters for either: <ul style="list-style-type: none"> ● the communication module, or ● a communication channel 	3 Page tabs	Select a page to display module or channel properties: <ul style="list-style-type: none"> ● for the communication module: <ul style="list-style-type: none"> ○ Overview ○ Fault ○ I/O Objects ● for a communication channel: <ul style="list-style-type: none"> ○ Configuration ○ Debug ○ Fault 	4 General parameters	View communication channel parameters: <ul style="list-style-type: none"> ● Function displays the configured communication function and is read-only. ● Task displays the task (configured MAST) and is read-only. 	5 Mode parameters	Displays parameters for the mode you select by opening a page.
1 Module status icons	These three indicators display the module's status in online mode.										
2 Channel area	Select a node to display parameters for either: <ul style="list-style-type: none"> ● the communication module, or ● a communication channel 										
3 Page tabs	Select a page to display module or channel properties: <ul style="list-style-type: none"> ● for the communication module: <ul style="list-style-type: none"> ○ Overview ○ Fault ○ I/O Objects ● for a communication channel: <ul style="list-style-type: none"> ○ Configuration ○ Debug ○ Fault 										
4 General parameters	View communication channel parameters: <ul style="list-style-type: none"> ● Function displays the configured communication function and is read-only. ● Task displays the task (configured MAST) and is read-only. 										
5 Mode parameters	Displays parameters for the mode you select by opening a page.										

Communication Channel Diagnostics in Control Expert

Overview

Select a communication channel in the **Channel area** to access the:

- **Configuration** page, where you can:
 - edit the EtherNet/IP Module name
 - edit input and output data size and location settings
 - launch the Control Expert EtherNet/IP configuration tool
- Refer to the description of the **Configuration** page (*see page 38*) for more information.
- **Debug** page, which displays the communication module's:
 - MAC Address
 - IP Address settings
- **Fault** page, which displays active detected faults for the communication channel

MAC Address

To display the MAC Address of the communication module:

Step	Action
1	In the Channel area , select the communication channel. The following pages are displayed: <ul style="list-style-type: none"> ● Configuration ● Debug ● Default
2	To display the communication module's MAC Address and IP Address settings, click on the Debug page: <div data-bbox="274 958 926 1453" style="border: 1px solid gray; padding: 5px; margin-top: 10px;"> <p>Ethernet 1 Port 16/100 RJ45 Run ERR STS</p> <p>BMX NOC 0401 Channel 0</p> <p>Configuration Debug Fault</p> <p>Address Information</p> <p>MAC Address: 12.34.56.78.90.12</p> <p>IP Address: 192.168.001.004</p> <p>Subnetwork mask: 255.255.255.000</p> <p>Gateway address: 000.000.000.000</p> <p>Function: Ethernet</p> <p>Task: MAST</p> </div>

Channel Detected Faults

To display the active faults detected on the communication channel:

Step	Action
1	In the Channel area , select the communication channel.
2	To display the communication module's detected active faults, click on the Fault page:

The screenshot shows the configuration page for 'Ethernet 1 Port 10/100 RJ45'. At the top right, there are three status lights (green, red, yellow) and the text 'Run ERR STS'. Below this, there are three tabs: 'Configuration', 'Debug', and 'Fault'. The 'Fault' tab is selected and circled in red. Under the 'Fault' tab, there are three sections: 'Internal fault:', 'External fault:', and 'Other fault:'. The 'Other fault:' section contains the text 'Hardware config fault'. On the left side of the page, there is a tree view showing 'BMX NOC 0401' and 'Channel 0', both of which are circled in red. Below the tree view, there are two dropdown menus: 'Function:' with 'Ethernet' selected, and 'Task:' with 'MAST' selected.

NOTE: You can also access the channel detected error bit (CH_ERROR) by using the Control Expert **Animation Table** to display the `%I.r.m.ch.ERR` object.

Communication Module Diagnostics in Control Expert

Overview

Use the Ethernet Module window in Control Expert to diagnose the BMX NOC 0401 Ethernet communication module. In this window, you can access:

- three icons that reflect the current status of selected LEDs
- the **Overview** page, where you can view a description of the module
- **Fault** page, which displays detected active faults for the communication module
- **I/O Objects** page, where you can view and manage I/O objects for the module

Module Status Icons

The Ethernet Module window displays three icons that reflect the current status of the following LEDs:

- Run
- ERR
- STS

Refer to the description of LED indicators (*see page 326*) for information on how to use these icons.

Accessing Module Detected Faults

To display the detected active faults on the communication module:

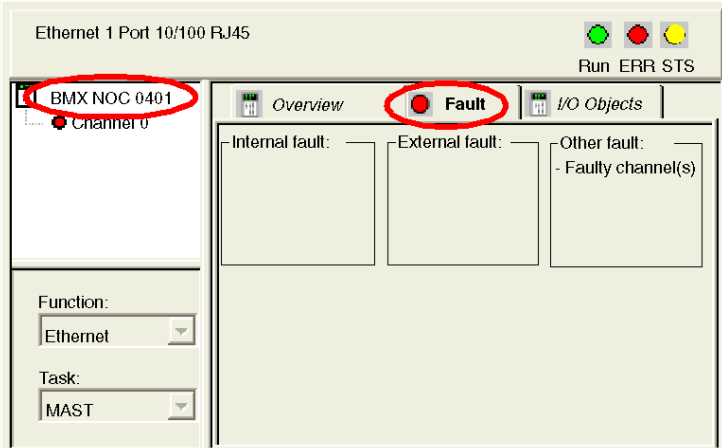
Step	Action
1	In the Channel area , select the communication module. The following pages are displayed: <ul style="list-style-type: none"> • Overview • Fault • I/O Objects
2	To display the communication module's active detected faults, click on the Fault page: 

NOTE: You can also access the module detected error bit by using the Control Expert **Animation Table** to display the `%I.r.m.MOD.ERR` object.

Managing I/O Objects

Use the I/O Objects page to view module I/O objects, and to manage the association of these objects with variables.

Open the **I/O Objects** page by selecting the **I/O Objects** tab, after the communication module has been selected in the **Channel area**:

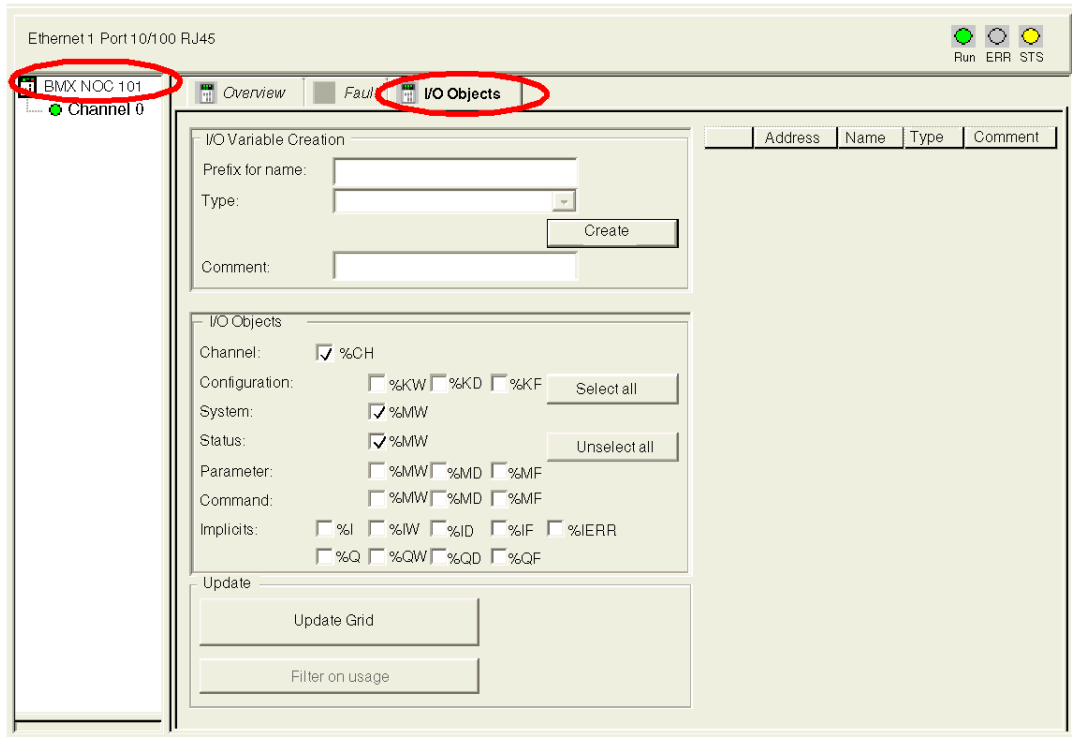

NOTE:

- The BMX NOC 0401 communication module supports only Channel, System, and Status I/O Objects. Not every bit is used.
- Refer to the Control Expert help for instructions on how to use the **I/O Objects** page.

Reading I/O Objects

Use a `READ_STS` function block in Control Expert to update each of the following types of data:

- module data
- channel data

Updating module data:

To display module information, follow these steps:

Step	Action																	
1	<p>Configure the <code>READ_STS</code> function block, as follows:</p> <div style="text-align: center;"> <pre> graph LR A["%Chr.m.MOD"] --- B["CH"] B --- C["READ_STS"] </pre> </div> <p>Where:</p> <p>r = rack or station number</p> <p>m = module or slot number</p> <p>MOD = a constant indicating module data</p>																	
2	<p>To view the data updated by the <code>READ_STS</code> function block, enter the corresponding direct addresses in the Control Expert Animation table, or use them in your program logic:</p> <table border="1"> <thead> <tr> <th>Object</th> <th>Description</th> </tr> </thead> <tbody> <tr> <td><code>%lr.m.MOD.ERR</code></td> <td>Module detected error bit <code>%lr.m.MOD.ERR</code> is implicitly updated based on <code>%lr.m.0.ERR</code></td> </tr> <tr> <td><code>%MWr.m.MOD.0</code></td> <td>Exchange Status: Bit 0: reading of module status in progress</td> </tr> <tr> <td><code>%MWr.m.MOD.1</code></td> <td>Exchange Report: Bit 0: detected error while reading module status</td> </tr> <tr> <td rowspan="8"><code>%MWr.m.MOD.2</code></td> <td>Bit 0: internal fault detected</td> </tr> <tr> <td>Bit 1: operational fault detected</td> </tr> <tr> <td>Bit 2: not used</td> </tr> <tr> <td>Bit 3: self test</td> </tr> <tr> <td>Bit 4: not used</td> </tr> <tr> <td>Bit 5: configuration fault detected</td> </tr> <tr> <td>Bit 6: missing module or off</td> </tr> <tr> <td>Bit 7: not used</td> </tr> </tbody> </table>	Object	Description	<code>%lr.m.MOD.ERR</code>	Module detected error bit <code>%lr.m.MOD.ERR</code> is implicitly updated based on <code>%lr.m.0.ERR</code>	<code>%MWr.m.MOD.0</code>	Exchange Status: Bit 0: reading of module status in progress	<code>%MWr.m.MOD.1</code>	Exchange Report: Bit 0: detected error while reading module status	<code>%MWr.m.MOD.2</code>	Bit 0: internal fault detected	Bit 1: operational fault detected	Bit 2: not used	Bit 3: self test	Bit 4: not used	Bit 5: configuration fault detected	Bit 6: missing module or off	Bit 7: not used
Object	Description																	
<code>%lr.m.MOD.ERR</code>	Module detected error bit <code>%lr.m.MOD.ERR</code> is implicitly updated based on <code>%lr.m.0.ERR</code>																	
<code>%MWr.m.MOD.0</code>	Exchange Status: Bit 0: reading of module status in progress																	
<code>%MWr.m.MOD.1</code>	Exchange Report: Bit 0: detected error while reading module status																	
<code>%MWr.m.MOD.2</code>	Bit 0: internal fault detected																	
	Bit 1: operational fault detected																	
	Bit 2: not used																	
	Bit 3: self test																	
	Bit 4: not used																	
	Bit 5: configuration fault detected																	
	Bit 6: missing module or off																	
	Bit 7: not used																	

Updating channel data:

To display channel information, follow these steps:

Step	Action																																											
1	<p>Configure the <code>READ_STS</code> function block, as follows:</p> <div style="text-align: center;"> <pre> graph LR A["%CHr.m.ch"] --- B["CH"] B --- C["READ_STS"] </pre> </div> <p>Where:</p> <p>r = rack, or station, number</p> <p>m = module, or slot, number</p> <p>ch = channel number—set to 0 for ETC transactions</p>																																											
2	<p>To view the data updated by the <code>READ_STS</code> function block, enter the corresponding direct addresses in the Control Expert Animation table, or use them in your program logic:</p> <table border="1"> <thead> <tr> <th>Object</th> <th>Description</th> <th>Standard Symbol</th> </tr> </thead> <tbody> <tr> <td><code>%lr.m.ch.ERR</code></td> <td>Channel detected error bit</td> <td><code>CH_ERROR</code></td> </tr> <tr> <td rowspan="10"><code>%lr.m.ch.0</code></td> <td>Status of Ethernet services:</td> <td>—</td> </tr> <tr> <td>Bit 0: EIP Scanner (0 = OK, 1 = NOK)</td> <td>—</td> </tr> <tr> <td>Bit 1: EIP Adapter (0 = OK, 1 = NOK)</td> <td>—</td> </tr> <tr> <td>Bit 2: EIP Client (0 = OK, 1 = NOK)</td> <td>—</td> </tr> <tr> <td>Bit 3: EIP Server (0 = OK, 1 = NOK)</td> <td>—</td> </tr> <tr> <td>Bit 4: Modbus scanner (0 = OK, 1 = NOK)</td> <td>—</td> </tr> <tr> <td>Bit 5: Modbus TCP Client (0 = OK, 1 = NOK)</td> <td>—</td> </tr> <tr> <td>Bit 6: Modbus TCP Server (0 = OK, 1 = NOK)</td> <td>—</td> </tr> <tr> <td>Bit 7: FDR Server (0 = OK, 1 = NOK)</td> <td>—</td> </tr> <tr> <td>Bit 8: RSTP (0 = OK, 1 = NOK)</td> <td>—</td> </tr> <tr> <td>Bit 9–Bit 15: reserved</td> <td>—</td> </tr> <tr> <td rowspan="3"><code>%MWr.m.ch.0</code></td> <td>Exchange Status:</td> <td><code>EXCH_STS</code></td> </tr> <tr> <td>Bit 0: reading of status words of the channel in progress</td> <td><code>STS_IN_PROG</code></td> </tr> <tr> <td>Bit 1: command write in progress</td> <td><code>CMD_IN_PROG</code></td> </tr> <tr> <td rowspan="3"><code>%MWr.m.ch.1</code></td> <td>Exchange Report:</td> <td><code>EXCH_RPT</code></td> </tr> <tr> <td>Bit 0: detected error while reading channel status</td> <td><code>STS_ERR</code></td> </tr> <tr> <td>Bit 1: detected error while writing a command to the channel</td> <td><code>CMD_ERR</code></td> </tr> </tbody> </table>	Object	Description	Standard Symbol	<code>%lr.m.ch.ERR</code>	Channel detected error bit	<code>CH_ERROR</code>	<code>%lr.m.ch.0</code>	Status of Ethernet services:	—	Bit 0: EIP Scanner (0 = OK, 1 = NOK)	—	Bit 1: EIP Adapter (0 = OK, 1 = NOK)	—	Bit 2: EIP Client (0 = OK, 1 = NOK)	—	Bit 3: EIP Server (0 = OK, 1 = NOK)	—	Bit 4: Modbus scanner (0 = OK, 1 = NOK)	—	Bit 5: Modbus TCP Client (0 = OK, 1 = NOK)	—	Bit 6: Modbus TCP Server (0 = OK, 1 = NOK)	—	Bit 7: FDR Server (0 = OK, 1 = NOK)	—	Bit 8: RSTP (0 = OK, 1 = NOK)	—	Bit 9–Bit 15: reserved	—	<code>%MWr.m.ch.0</code>	Exchange Status:	<code>EXCH_STS</code>	Bit 0: reading of status words of the channel in progress	<code>STS_IN_PROG</code>	Bit 1: command write in progress	<code>CMD_IN_PROG</code>	<code>%MWr.m.ch.1</code>	Exchange Report:	<code>EXCH_RPT</code>	Bit 0: detected error while reading channel status	<code>STS_ERR</code>	Bit 1: detected error while writing a command to the channel	<code>CMD_ERR</code>
Object	Description	Standard Symbol																																										
<code>%lr.m.ch.ERR</code>	Channel detected error bit	<code>CH_ERROR</code>																																										
<code>%lr.m.ch.0</code>	Status of Ethernet services:	—																																										
	Bit 0: EIP Scanner (0 = OK, 1 = NOK)	—																																										
	Bit 1: EIP Adapter (0 = OK, 1 = NOK)	—																																										
	Bit 2: EIP Client (0 = OK, 1 = NOK)	—																																										
	Bit 3: EIP Server (0 = OK, 1 = NOK)	—																																										
	Bit 4: Modbus scanner (0 = OK, 1 = NOK)	—																																										
	Bit 5: Modbus TCP Client (0 = OK, 1 = NOK)	—																																										
	Bit 6: Modbus TCP Server (0 = OK, 1 = NOK)	—																																										
	Bit 7: FDR Server (0 = OK, 1 = NOK)	—																																										
	Bit 8: RSTP (0 = OK, 1 = NOK)	—																																										
Bit 9–Bit 15: reserved	—																																											
<code>%MWr.m.ch.0</code>	Exchange Status:	<code>EXCH_STS</code>																																										
	Bit 0: reading of status words of the channel in progress	<code>STS_IN_PROG</code>																																										
	Bit 1: command write in progress	<code>CMD_IN_PROG</code>																																										
<code>%MWr.m.ch.1</code>	Exchange Report:	<code>EXCH_RPT</code>																																										
	Bit 0: detected error while reading channel status	<code>STS_ERR</code>																																										
	Bit 1: detected error while writing a command to the channel	<code>CMD_ERR</code>																																										

Step	Action		
2 cont'd	%MWr.m.ch.2	Standard channel status (low byte):	—
		Bits 0...3: reserved (0)	—
		Bit 4: internal fault detected	—
		Bit 5: not used (0)	—
		Bit 6: X-Bus communication fault detected	—
		Bit 7: application fault detected (conf fault detected)	—
		High byte:	—
		Bits 0...7: reserved (0)	—
	%MWr.m.ch.3	Ethernet Port Global Status:	ETH_PORT_STATUS
		Bit 0: detected configuration error	—
		Bit 1: the Ethernet interface is disabled	—
		Bit 2: duplicate IP address detected	—
		Bit 3: configuration mismatch	—
		Bit 4: reserved	—
		Bit 5: the module is in the process of obtaining an IP address	—
		Bits 6...15: reserved	—
	%MWr.m.ch.4	IP address (IP_ADDR):	IP_ADDR
		<ul style="list-style-type: none"> During normal operation, the double word %MDr.m.c.4 contains the IP address configured or served to the module. 	—
		<ul style="list-style-type: none"> In No Configuration state, the double word %MDr.m.c.4 contains the default IP address of the module. 	—
		<ul style="list-style-type: none"> In Configuration Error detected state, the double word %MDr.m.c.4 contains the default IP address of the module. 	—
<ul style="list-style-type: none"> When a duplicate IP address is detected, the double word %MDr.m.c.4 contains the served or configured duplicate IP address. 		—	
<ul style="list-style-type: none"> When the module is waiting for a BOOTP response, the double word %MDr.m.c.4 contains the IP address 0.0.0.0. 		—	

Chapter 10

Replacing the Ethernet Communication Module

Replacing the Ethernet Communication Module

Overview

Replacing The module involves removing the old module and mounting a new one in its place

When to Replace

You can replace the communication module at any time using another module with compatible firmware. A module can be replaced when power to the module is either:

- off (cold swap), or
- on (hot swap)

The replacement module obtains its operating parameters over the backplane connection from the CPU. The transfer occurs either immediately (hot swap) or when power is next cycled to the device (cold swap).

NOTE: Operating parameters, that were added to the configuration using explicit messaging “SET” commands, are not included in the parameters that the CPU sends to a replacement module.

To install the replacement module, follow the instructions in the module mounting procedure (*see page 24*).

Chapter 11

Embedded Web Pages

Overview

This chapter describes the embedded web pages for the BMX NOC 0401 Ethernet communication module.

The communication module includes a Hypertext Transfer Protocol (HTTP) server. The server transmits web pages for the purpose of monitoring, diagnosing, and controlling remote access to the communication module. The server provides easy access to the communication module from standard internet browsers, including—but not limited to—Internet Explorer.

What Is in This Chapter?

This chapter contains the following sections:

Section	Topic	Page
11.1	Accessing the Embedded Web Server	370
11.2	Monitoring the Control Expert Application	378
11.3	Diagnostics	391

Section 11.1

Accessing the Embedded Web Server

Introduction

This section introduces the BMX NOC 0401 communication module's embedded web server, and describes how to access—and to control access to—the web pages.

What Is in This Section?

This section contains the following topics:

Topic	Page
Introducing the Embedded Web Pages	371
Accessing the Home Page	372
Using and Editing a Username and Passwords	373
Configuring Port Mirroring	376

Introducing the Embedded Web Pages

Introduction

Use the BMX NOC 0401 Ethernet communication module's embedded web server pages to:

- display real-time diagnostic data for both the module and other networked devices
- read the values of—and write values to—Control Expert application variables
- manage and control access to the embedded web pages by assigning separate passwords for:
 - viewing the diagnostic web pages, and
 - using the Data Editor to write values to Control Expert application variables

Requirements

The embedded web server presents module data in the form of standard HTML web pages.

Access the embedded web pages using Internet Explorer version 4.0 or higher, running the Java Runtime Environment (JRE) version 1.6 or higher.

Accessing the Home Page

On First Use

Before you begin to use the BMX NOC 0401 communication module's embedded web pages, you need to:

- navigate to the web server
- access web page content by inputting the default username and password (*see page 373*) combination
- change passwords (*see page 374*) that are required for:
 - accessing web pages, and
 - writing data values using the **Data Editor**

Navigating to the Web Server

To access the embedded web server, open an Internet browser, then enter the IP address (*see page 70*) of the Ethernet communication module in the format: *http://IP address*, then click **Enter**.

NOTE: If a DNS name has been assigned to the module, the DNS name can be used instead of the IP address.

The web server opens, displaying the **Home** page:

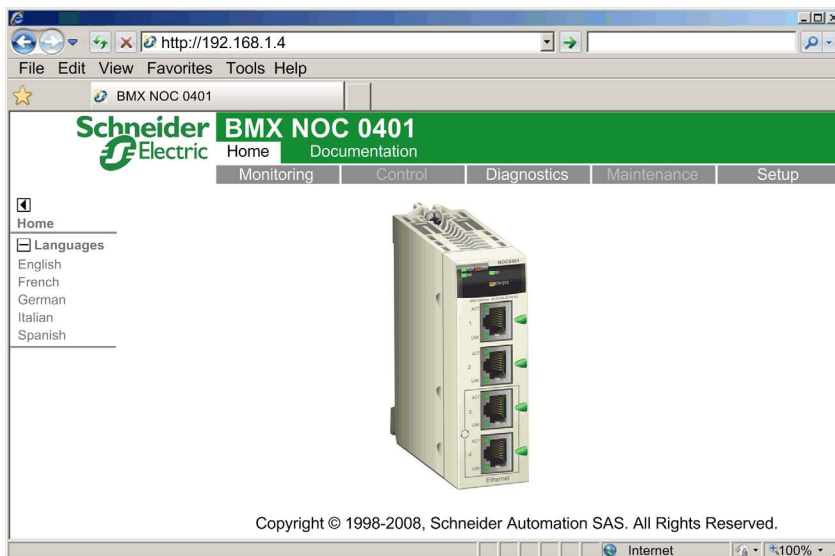

Use the **Home** page as the point of entry to the communication module's embedded web server. From here, you can navigate to every other web page.

Using and Editing a Username and Passwords

Inputting the Username and Web Page Access Password

A username and password are required to access web page content and edit application data. All username and password settings are case sensitive.

The embedded web pages support the use of a single, editable username for both web page access and data editing. The factory-default username setting is **USER**.

The embedded web pages require two different passwords, as follows:

- an HTTP access password, which grants read-only access to web page content
- a data editor write password, which permits the editing of data values using the **Data Editor**

Each password can be edited. The factory default setting for each password is **USER**.

To input a username and password combination

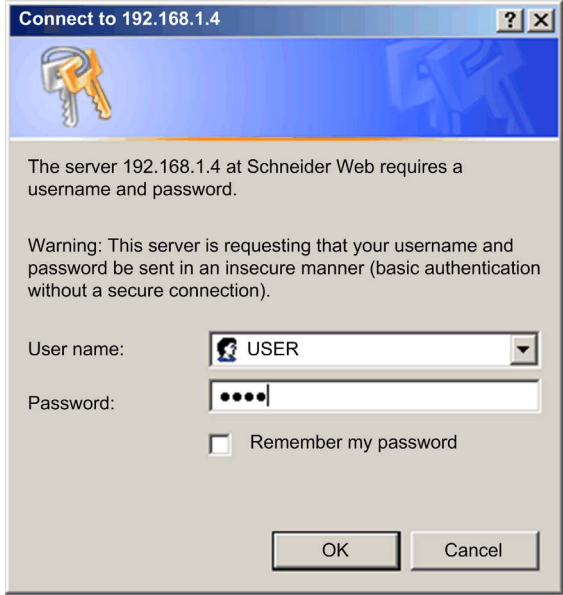
Step	Description
1	After navigating to the embedded web server (<i>see page 372</i>), select one of the main menu selections (for example, Setup).
2	<p>Select a page name from the list of pages on the left side of the page (for example, Security). The following dialog opens:</p> 
3	<p>Type in the required Username and Password combination, then click OK.</p> <p>NOTE: In the above example, the settings for both the Username and Password remain set to the default setting of USER.</p>

Editing the Username and Passwords

The single username and both passwords can be edited in the **Security** web page. To edit username and passwords, follow these steps:

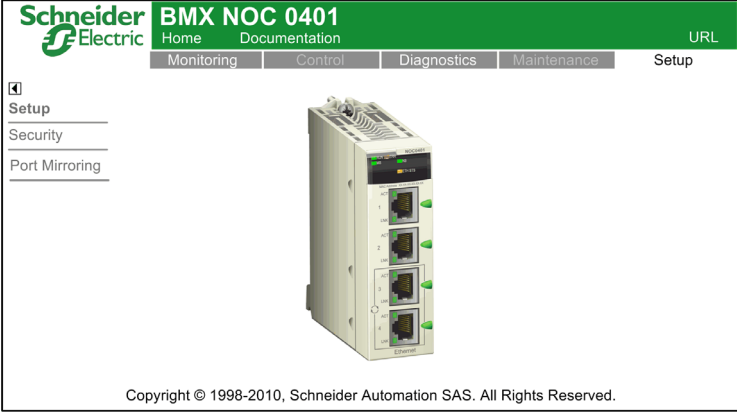
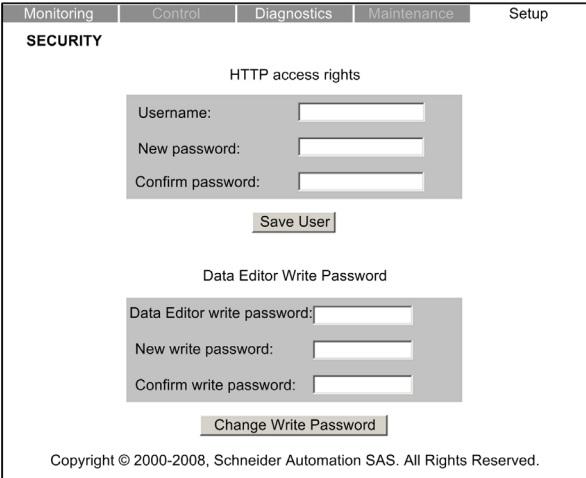
Step	Description
1	Navigate to and open the web server, (<i>see page 372</i>) using the IP address of the communication module. The Home page opens.
2	<p>From the Home page, click on the Setup main menu item. If required, input the username and web page password (<i>see page 373</i>). The Setup page opens:</p> 
3	<p>On the left side of the page, click on the Security node. (If required, input the Username and web page access Password.) The Security page opens:</p> 

Step	Description	
4	To change the username and password combination used for web page access, in the HTTP access rights section of the page, enter values for the following fields:	
	Username:	<ul style="list-style-type: none"> ● To change the username: type in a new username ● To retain the current username (for example, if you are changing only the password): type in the current username
	New password:	<ul style="list-style-type: none"> ● To change the password: type in a new password ● To keep the current password (for example, if you are changing only the username): type in the current password
	Confirm password:	Type in the same password entered in the New password field, above.
5	Click the Save User button.	
6	To change the password used for writing data values in the Data Editor , in the Data Editor Write Password section of the page, enter values for the following fields:	
	Data Editor write password:	Type in the current password that is required to write data using the Data Editor .
	New write password:	Type in the new Data Editor password.
	Confirm write password:	Type in the same password entered in the New write password field, above.
7	Click the Change Write Password button.	

Configuring Port Mirroring

Enabling Port Mirroring in Control Expert

You can use the port mirroring service to duplicate the traffic entering and exiting any one of the four Ethernet ports (the source port) onto another one of the ports (the destination port), for the purpose of diagnosing the source port.

NOTE:

- Verify that the port mirroring service is enabled in Control Expert (*see page 78*) before configuring it in the web pages.
- You can designate only non-RSTP enabled ports as the destination port.
- The port mirroring configuration settings are transient, and are cleared when you reboot the Ethernet communication module.

Configuring Port Mirroring in the Web Pages

To configure port mirroring, follow these steps:

Step	Description
1	In Control Expert, enable the port mirroring service (<i>see page 78</i>) to globally enable port mirroring.
2	Navigate to and open the web server, (<i>see page 372</i>) using the IP address of the communication module. The Home page opens.
3	From the Home page, click on the Setup main menu item. If required, input the username and web page password (<i>see page 373</i>). The Setup page opens: 

Step	Description						
4	<p>On the left side of the page, click on the Port Mirroring node. The Port Mirroring page opens:</p> 						
5	<p>Configure the following fields:</p> <table border="1" data-bbox="312 656 1258 818"> <tr> <td data-bbox="312 656 445 693">Enable:</td> <td data-bbox="445 656 1258 693">Place a check mark in this field to enable port mirroring. (Default = de-selected.)</td> </tr> <tr> <td data-bbox="312 693 445 753">Source:</td> <td data-bbox="445 693 1258 753">Select a port (1...4). The traffic from this port will be duplicated and sent to the destination port for diagnosis.</td> </tr> <tr> <td data-bbox="312 753 445 818">Destination:</td> <td data-bbox="445 753 1258 818">Select a port—other than the source port—to receive the duplicated traffic of the source port. Only ports with RSTP disabled can be selected.</td> </tr> </table>	Enable:	Place a check mark in this field to enable port mirroring. (Default = de-selected.)	Source:	Select a port (1...4). The traffic from this port will be duplicated and sent to the destination port for diagnosis.	Destination:	Select a port—other than the source port—to receive the duplicated traffic of the source port. Only ports with RSTP disabled can be selected.
Enable:	Place a check mark in this field to enable port mirroring. (Default = de-selected.)						
Source:	Select a port (1...4). The traffic from this port will be duplicated and sent to the destination port for diagnosis.						
Destination:	Select a port—other than the source port—to receive the duplicated traffic of the source port. Only ports with RSTP disabled can be selected.						
6	Click the Save button.						

Section 11.2

Monitoring the Control Expert Application

Overview

This section describes how to use the BMX NOC 0401 Ethernet communication module's embedded web pages to monitor the Control Expert application.

What Is in This Section?

This section contains the following topics:

Topic	Page
Using the Monitoring Page	379
Data Editor (Standard)	380
Working With Data Templates	385
Data Editor (Lite)	389

Using the Monitoring Page

Monitoring Page

Select the **Monitoring** tab at the top of the window to display the **Monitoring** page:



To access a monitoring service, click on either of the following links:

- **Data Editor Lite**
- **Data Editor Standard**

NOTE: The Data Editor web page for the BMXP3420•0 CPU modules uses located memory addresses only; they are not FactoryCast compatible. Only FactoryCast modules, like the BMXNOE0110 or BMENOC0311 modules, can be included in a Web Designer project that uses Control Expert symbols.

Data Editor (Standard)

Overview

The **Data Editor** is a Java applet that dynamically displays run-time application data. Use the **Data Editor** to create and edit data monitoring tables that provide read/write access to application data and device registers.

NOTE: Write access is password protected.

WARNING

Unintended Equipment Operation

The data editor makes it possible to write to application variables and change application data values.

- Use passwords to strictly limit access to write data functionality.
- Do not use weak passwords, including the default password and other obvious passwords.
- Limit access to trained personnel.

Failure to follow these instructions can result in death, serious injury, or equipment damage.

This topic describes the **Data Editor** user interface.

Data Editor

The **Data Editor** presents the following controls:

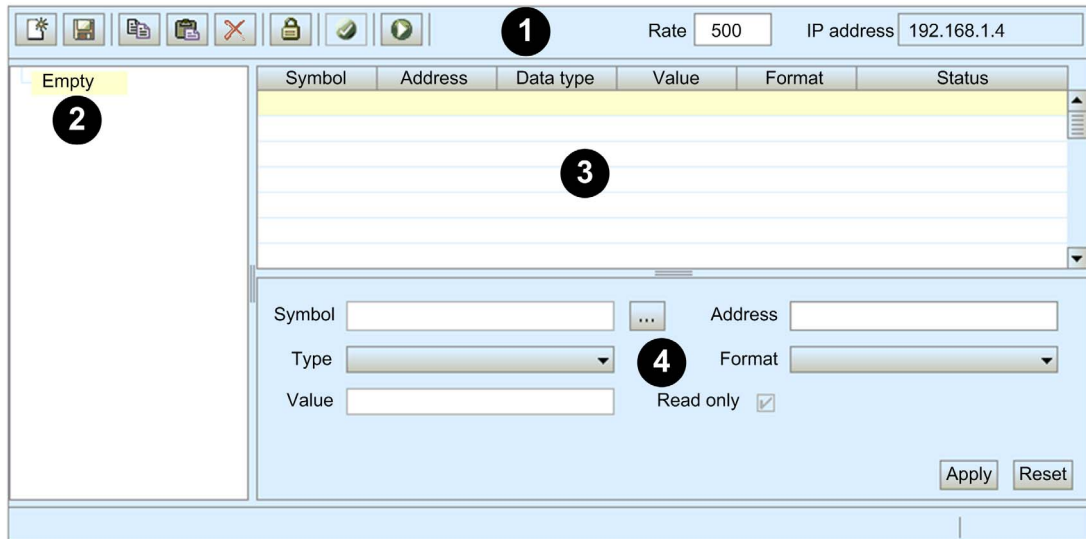







- 1 Toolbar
- 2 Data template list
- 3 Data template
- 4 Configuration Area

Toolbar

The **Data Editor** toolbar presents the following features:

Command or Field	Icon	Description
New		<ul style="list-style-type: none"> • If a node in the data template list is selected, this command opens the New table dialog for the creation of a new data template. The new data template is inserted below the selected node. • If a row in the currently open data template is selected, this command inserts a new row below the selected row.
Save		Saves changes made to both the data template list and each data template.
Copy		<ul style="list-style-type: none"> • If a node in the data template list is selected, this command copies the selected data template. • If an item (or row) in the currently open data template is selected, this command to copies the selected item.

Command or Field	Icon	Description
Paste		<ul style="list-style-type: none"> • If the root, or Empty, node is selected in the data template list, this command pastes a previously copied data template into the list. • If an empty item (or row) in the currently open data template is selected, this command pastes a previously copied item into the data template item at the selected row. <p>NOTE: When adding a copied item, or row, to a data template, the paste command will overwrite item data in the selected row. To insert a copied row between existing rows, first use the New command to create an empty row, then paste the copied data into the new row.</p>
Delete		Deletes the selected data template from the list, or the selected item from the data template.
Change password		Opens the Change password dialog, where you can change the Data Editor Write (<i>see page 374</i>) password. NOTE: The Data Editor Write password can also be changed in the Setup → Security web page.
Read PLC symbols		Loads the existing Control Expert symbol—or variable—names into the Lookup Variable dialog. Variables that have been loaded into this dialog can be added to the currently open data template.
Start animation		Starts the dynamic display of value and status for the items contained in the selected data template. NOTE: The Start animation icon is visible only when animation is turned OFF.
Stop animation		Stops the dynamic display of value and status for the items contained in the selected data template. NOTE: The Stop animation icon is visible only when animation is turned ON.
Rate	—	The refresh rate of the dynamic display of data template items, in milliseconds.
IP address	—	The IP address of the Ethernet communication module and its embedded web server.

Data Template List

The data template list displays a node for each data template that was either:

- previously saved, or
- created after the **Data Editor** was opened, but not yet saved

Select a data template in this list to view or edit its contents.

NOTE: If you create a new data template, then navigate away from the **Data Editor** before clicking the **Save** button, the new data template will be lost.

Data Template

Use the data template—when animation is turned ON—to monitor the status and values of items for the template that is currently selected in the data template list.

Each data template item (or row) is defined in the configuration area. A data template item can contain the following fields:

Field	Description	
Symbol	Contains the names of Control Expert symbols (variables).	
Address	Contains direct addresses and the addresses of Control Expert symbols (variables). Any direct address can be viewed by entering its reference in this field. Valid direct addresses include:	
	%Mi	same as for 0X coils
	%Ii	same as 1x for discreet inputs
	%IWi	same as 3x for input registers
	%MWi, %MDi, %MFi	same as 4x for holding registers
	<p>NOTE:</p> <ul style="list-style-type: none"> • A single bit of any word address (for example, %MWi, %IWi) can be specified by appending ".j" to the address, where "j" is a bit index in the range of 0 (LSB) to 15 (MSB). For example, bit 4 of the value at %MW101 would be specified as %MW101.4. • A direct address can include an index specification that allows it to be treated as an array variable. Indexed addressing can be used with a %Mi, %MWi, %MDi, or %MFi address by appending "[j]" to the address of the beginning of the array, where "j" is an unsigned integer value. For example, the third value of an array of float values starting at %MF201 would be specified as %MF201[2]. 	
Data type	Contains the data type of the symbol (variable) or direct address. Symbol (variable) data types appear automatically when the symbol (variable) is located. Select direct address data types from a drop-down list. The following data types are valid:	
	INT	16-bit signed integer
	UINT	16-bit unsigned integer
	DINT	32-bit signed integer
	UDINT	32-bit unsigned integer
	REAL	32-bit IEEE floating point
	TIME	32-bit unsigned integer (in ms)
	DATE	Date (32-bit BCD)
	TOD	Time of day (32-bit BCD)
	BOOL	1 bit discrete (Boolean)
Value	When animation has started, this field displays the value of the symbol (variable) or direct address. This field is updated continuously.	

Field	Description	
Format	Contains the format type for displaying the value of the symbol (variable) or direct address. The following formats are available:	
	bool	Boolean
	dec	Decimal
	hex	Hexadecimal
	binary	Binary
	ASCII	bytes displayed as ASCII characters
	time	day_hr_min_sec_ms
	date	YYYY-MM-DD or HH:MM:SS
Status	Contains messages describing the status of communication with the direct address:	
	if communication is normal	The status message reads OK
	if communication is interrupted	The status field displays a system message describing the interruption

Configuration Area

Open and close the configuration area by double-clicking on a row in the data template. The configuration area will display the configuration settings for the selected row. Use the up and down arrows on your keyboard to move between rows in the data template and display their settings in the configuration area.

Use the configuration area—when data template animation is turned OFF—to:

- create a new data template (*see page 385*)
- display the items contained in an existing data template (*see page 387*)
- add a direct address (*see page 387*) to a data template

Use the configuration area—when data template animation is turned ON—to write data to read/write application variables.



Refer to the topic Working With Data Templates for more information on how to use the controls in the configuration area.

Working With Data Templates

Creating a Data Template

To display and access application data, first create a data template.

To create a new data template, follow these steps:

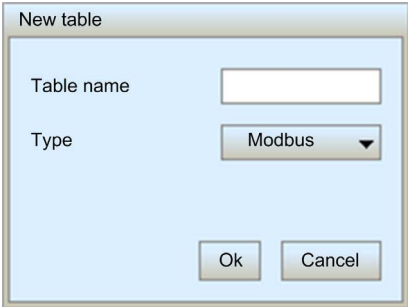
Step	Description
1	Confirm that Data Editor animation is OFF. If necessary, click the Stop animation  toolbar button.
2	<p>Click the New table  toolbar button.</p> <p>The New table dialog opens:</p> 
3	In the Table name field, type in the name of the new data template.
4	Click Ok . The new data template appears as a node in the data template list.

NOTE: Save the new data template before performing any other task in the **Data Editor**. Moving to another page—or creating a new data template in the current page—before saving your work deletes the new data template.

Saving a Data Template

After you save a new data template, you can re-use it to view or modify its contents.

NOTE:

- Be careful when you modify and save a data template. The last saved modification overwrites the pre-existing data template, even if the data template was originally created by someone other than yourself.
- If a data template is open for viewing by someone else, your edits to that data template will be seen only when that person next accesses the **Data Editor**.

To save a new data template, follow these steps:

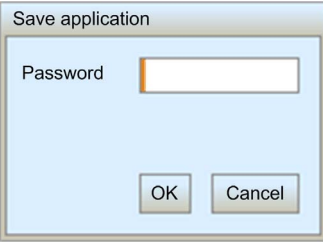
Step	Description
1	<p>Click the Save  toolbar button. The Save application dialog opens:</p> 
2	<p>In the Password field, type in the Web Page (HTTP) Access password. NOTE: The default password is USER.</p>
3	<p>Click Ok. The new data template is saved.</p>

Displaying an Existing Data Template

When you open a saved data template, you can use it to:

- edit its contents by inserting a direct address
- monitor the value and status of data items
- write data values to a read/write variables

The data template list, located on the left side of the **Data Editor**, displays the saved data templates. Select a data template node from the list to display that template's data items in the spreadsheet on the right:

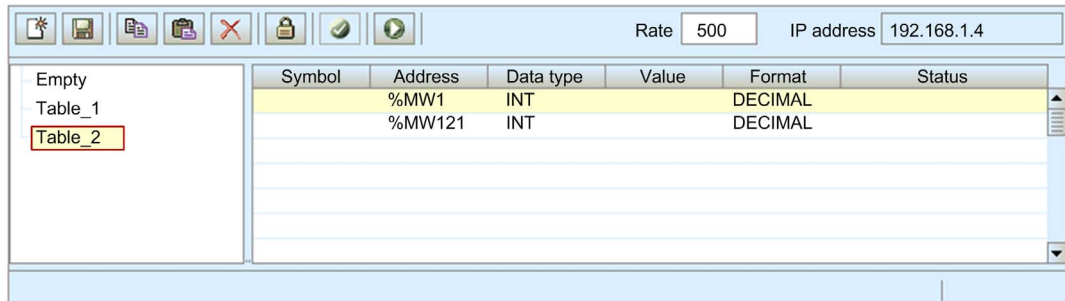

Inserting a Direct Address Into a Data Template

You can add Control Expert direct address items—also called located registers—into a data template. After a direct address item is added, you can view or modify its value.

To add a direct address item to a data template, follow these steps:

Step	Description
1	In the data template spreadsheet, double-click on an empty row. The Data Editor configuration area opens.
2	In the Address field of the configuration area, type in the item's direct address.
3	In the configuration area, click Apply . The selected row is updated.
4	Save your edits.

Modifying Data Values Using a Data Template

You can use the **Data Editor** to write data values to a direct address item, and send the new value to the controller.

For example, suppose that you have programmed a pushbutton object to jog a motor when the button is depressed and to stop jogging when the button is released. If communications are lost while the button is depressed, the motor will continue to jog even when the button is released. Graphic objects are not designed to be used to control situations like this, unless other interlock methods are installed in the system.

NOTE: You can only modify the value of data items that are defined as read/write in the Control Expert application.

To use the **Data Editor** to edit data, follow these steps:

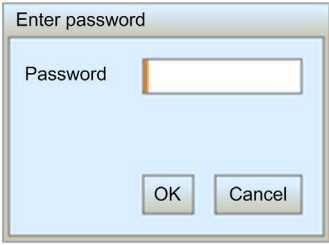
Step	Description
1	In the data template spreadsheet, double-click on the item you want to write data to. The Data Editor configuration area opens, displaying the fields for the selected item.
2	In the Value field, type in the desired data value.
3	Click Apply . The Enter password dialog opens: 
4	In the Password field, type in the Write Data password. NOTE: The default password is USER .
5	Click OK . The new value is sent to the controller.

Data Editor (Lite)

Overview

Data Editor Lite is a version of the **Data Editor** that is smaller in size and therefore faster to download, especially for use via a dial-up connection.

Data Editor Lite presents the same interface as the **Data Editor**, with the exception that its toolbar does not include the **Read PLC Symbols** function:

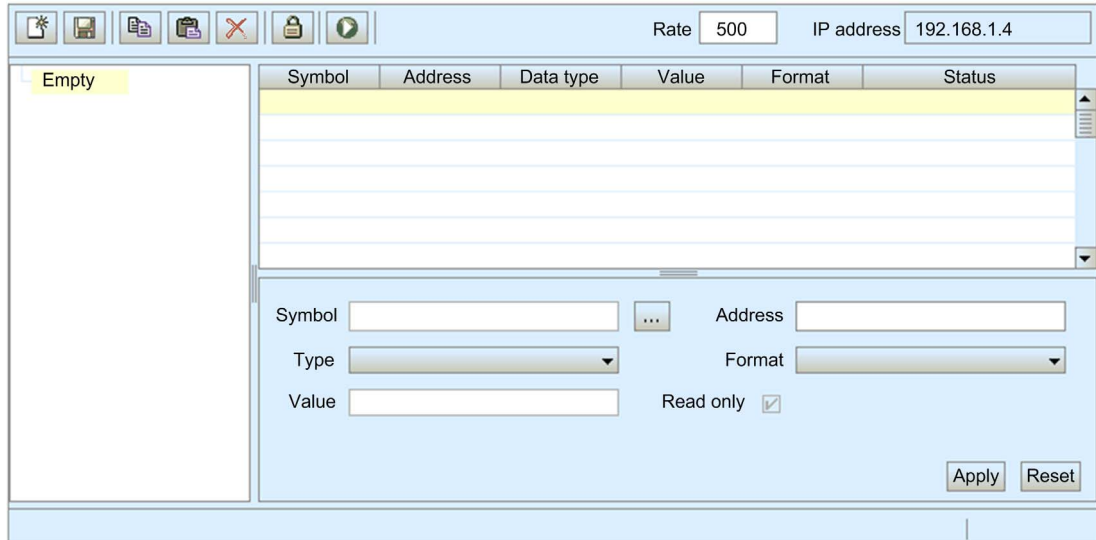

Variables

Data Editor Lite accepts the following IEC variables:

Address	Type	Display
%MW IEC internal word	INT	DECIMAL
%MD IEC double word	DINT	DECIMAL
%M IEC internal bits	BOOL	BOOLEAN

NOTE: You cannot access the **Lookup Variable** dialog and insert symbols into a data template using **Data Editor Lite**. You can insert only direct addresses.

Re-Using Data Editor Templates

Data Editor Lite can reuse the same templates created with the **Data Editor**. However, **Data Editor** templates can use a wider range of variable types than **Data Editor Lite**. When **Data Editor Lite** encounters a variable it cannot manage, it displays `Not Supported` as the data type. In this case, the variable cannot be edited using **Data Editor Lite**.

Section 11.3

Diagnostics

Overview

This section describes the diagnostic services provided by the BMX NOC 0401 Ethernet communication module.

What Is in This Section?

This section contains the following topics:

Topic	Page
Using the Diagnostics Page	392
Status Summary	393
Rack Viewer	396
Processor Load	398
Scanner Status	401
Messaging	403
QoS Configuration	405
Port Statistics	407
Redundancy	410
Email Diagnostics	411
Network Time Service Diagnostics	414
Properties	416

Using the Diagnostics Page

Diagnostics Page

Click on the main menu **Diagnostics** command to display the **Diagnostics** page:



To access a monitoring service, click on either of the following links:

- Status Summary (*see page 393*)
- Rack Viewer (*see page 396*)
- Ethernet:
 - Processor Load (*see page 398*)
 - Scanner Status (*see page 401*)
 - Messaging (*see page 403*)
 - QoS Configuration (*see page 405*)
- Switch
 - Port Statistics (*see page 407*)
 - Redundancy (*see page 410*)
- Network Time Service (*see page 414*)
- Email (*see page 411*)
- Properties (*see page 416*)

Status Summary

Introduction

Use the **Status Summary** page to view the status of:

- the LEDs (*see page 326*) located on the front of the BMX NOC 0401 Ethernet communication module
- the Ethernet services (*see page 78*) supported by the communication module
- the communication module in its role as:
 - scanner
 - Modbus TCP server
 - EtherNet/IP messaging server

Status Summary Display

The **Status Summary** page looks like this:

Monitoring	Control	Diagnostics	Maintenance	Setup																						
STATUS SUMMARY																										
LEDs																										
<table border="1" style="width: 100%; border-collapse: collapse;"> <thead> <tr> <th style="background-color: #cccccc;">Label</th> <th style="background-color: #cccccc;">Status</th> </tr> </thead> <tbody> <tr> <td>RUN</td> <td>Ready for Operation</td> </tr> <tr> <td>ERR</td> <td>No Fault Detected</td> </tr> <tr> <td>ETH STS</td> <td>In Operation</td> </tr> <tr> <td>MS</td> <td>In Operation</td> </tr> <tr> <td>NS</td> <td>Connections established</td> </tr> </tbody> </table>					Label	Status	RUN	Ready for Operation	ERR	No Fault Detected	ETH STS	In Operation	MS	In Operation	NS	Connections established										
Label	Status																									
RUN	Ready for Operation																									
ERR	No Fault Detected																									
ETH STS	In Operation																									
MS	In Operation																									
NS	Connections established																									
Services																										
<table border="1" style="width: 100%; border-collapse: collapse;"> <thead> <tr> <th style="background-color: #cccccc;">Function</th> <th style="background-color: #cccccc;">Status</th> </tr> </thead> <tbody> <tr> <td>DHCP Server</td> <td>Enabled</td> </tr> <tr> <td>FDR Server</td> <td>Enabled</td> </tr> <tr> <td>QoS Tagging</td> <td>Enabled</td> </tr> <tr> <td>IGMP Snooping</td> <td>Enabled</td> </tr> <tr> <td>Access Control</td> <td>Enabled</td> </tr> <tr> <td>Port Mirroring</td> <td>Enabled</td> </tr> <tr> <td>RSTP</td> <td>Enabled</td> </tr> <tr> <td>Network Time Service</td> <td>Enabled</td> </tr> <tr> <td>Email Service</td> <td>Enabled</td> </tr> <tr> <td>Scanner Status</td> <td>Not Configured</td> </tr> </tbody> </table>					Function	Status	DHCP Server	Enabled	FDR Server	Enabled	QoS Tagging	Enabled	IGMP Snooping	Enabled	Access Control	Enabled	Port Mirroring	Enabled	RSTP	Enabled	Network Time Service	Enabled	Email Service	Enabled	Scanner Status	Not Configured
Function	Status																									
DHCP Server	Enabled																									
FDR Server	Enabled																									
QoS Tagging	Enabled																									
IGMP Snooping	Enabled																									
Access Control	Enabled																									
Port Mirroring	Enabled																									
RSTP	Enabled																									
Network Time Service	Enabled																									
Email Service	Enabled																									
Scanner Status	Not Configured																									
Copyright © 2000-2012, Schneider Electric. All Rights Reserved.																										

To open this page:

Step	Action
1	Starting at the Home page , click the Diagnostics main menu item. The Diagnostics page opens.
2	On the left side of the Diagnostics page, select Ethernet → Status Summary .
3	If necessary, type in the HTTP web access password. NOTE: The default password is USER .

Status Summary Data

The **LEDs** section of the page can present the following operational states:

LED	Color	Text Descriptions
RUN	Green	Ready for operation
	Gray	Not ready for operation
ERR	Red	Fault detected
	Gray	No fault detected
ETH STS	Green	In operation
	Red	Duplicate IP
		Waiting for BootP server response
		Default IP Address in use
		IP Address Configuration conflict detected
MS (module status)	Green	In operation
	Red	Not configured
		Fault detected
		Recoverable fault detected
NS (network status)	Green	Connections established
	Red	No EtherNet/IP connections
		Connection error detected
		Duplicate IP address

The **Services** section of the page can present the following functional conditions:

Function	Color	Text Descriptions
DHCP Server	—	Enabled
FDR Server		Disabled
QoS Tagging		
IGMP Snooping		
Access Control		
Port Mirroring		
RSTP		
Network Time Service	—	Enabled
Email Service		Disabled
Scanner Status	Green	Working properly
	Red	At least one connection is bad
	Gray	Not configured

Rack Viewer

Introduction

Use the **Rack Viewer** to access web pages that describe the identity, placement, configuration and operation of modules in the M340 rack.

To view information describing a specific module—including the BMX NOC 0401 Ethernet communication module—click on the image of that module in the **Rack Viewer**.

Rack Display

The **Rack Viewer** looks like this, when it is first opened:

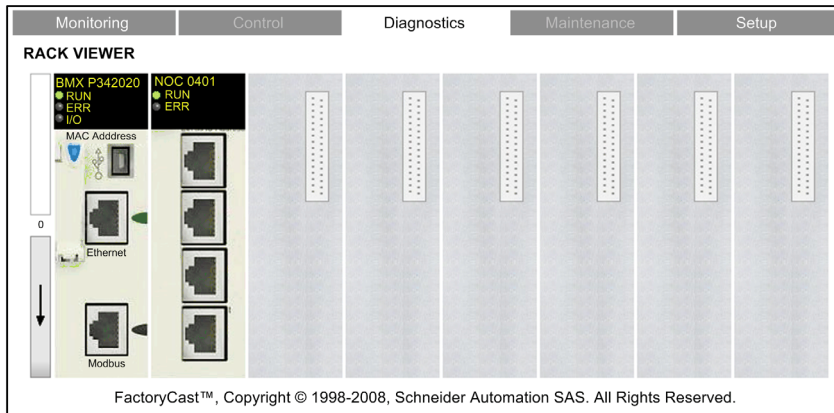

To open this page:

Step	Action
1	Starting at the Home page , click the Diagnostics main menu item. The Diagnostics page opens.
2	On the left side of the Diagnostics page, select Rack Viewer .
3	If necessary, type in the HTTP web access password. NOTE: The default password is USER .

Rack Viewer Displaying the BMX NOC 0401

When you click on the BMX NOC 0401 in the rack display, the following web page opens:

Monitoring	Control	Diagnostics	Maintenance	Setup	
RACK VIEWER					
Leds:	Rack:	0	Product Range:	M340	
● RUN	Slot:	1	Trade Type:	Communication	
● ERR	Module State:	Ok	Product Type:	Ethernet	
	Reference Present:	BMX NOC 0401	Reference Configured:	BMX NOC 0401	
	Version:	1.0			
Parameters					
IP Address:	192.168.1.4	Net mask:	255.255.255.0	Gateway:	0.0.0.0
Name:		MAC Address:	0.80.f4.1.fb.bc		
Services		Status		Counter	
Port 502:	True	Generic faults:	False	Refused port 502 connections:	0
IO Scanner:	True	Ethernet interface disabled:	False	Received messages (/sec):	25
Global data:	True	Duplicate IP Address:	False	Filter messages (/sec):	10
Emails:	True	Configuration mismatch:	False	Dropped messages (/sec):	0
Server FDR:	True	Ethernet link disconnected:	False	Max received messages (/sec):	2893
		Obtaining IP address:	False	Max Filter messages (/sec):	10112
		Self-test fault:	False	Max dropped messages (/sec):	46132
		Application faults:	False	Nb of Multicast (/sec):	9
				Nb of Broadcast (/sec):	2893
				<input type="button" value="Reset"/>	
					
FactoryCast™, Copyright © 1998-2008, Schneider Automation SAS. All Rights Reserved.					

Click on the blue **Back** arrow to return to the rack display.

Processor Load

Introduction

Use the **Processor Load** web page to display dynamically generated data for the BMX NOC 0401 communication module's bandwidth usage.

Processor Load Display

The **Processor Load** page looks like this:

Monitoring	Control	Diagnostics	Maintenance	Setup	
PROCESSOR LOAD					
Processor Load					
Module Load					
Processor Utilization		38	%		
Communication Load					
Function	Statistics		Units		
I/O	Scanner	EtherNet/IP Sent (writes)	31	Packets per second	
		EtherNet/IP Received (read)	33	Packets per second	
		Modbus TCP Requests	17	Packets per second	
		Modbus TCP Responses	16	Packets per second	
	Adapter	EtherNet/IP Sent (writes)	0	Packets per second	
		EtherNet/IP Received (read)	0	Packets per second	
	Module Capacity		12000	Packets per second	
	Module Utilization		0.8	%	
	Messaging	Client	EtherNet/IP activity	0	Messages per second
			Modbus TCP activity	0	Messages per second
Server		EtherNet/IP activity	0	Messages per second	
		Modbus TCP activity	0	Messages per second	
Copyright © 2000-2009, Schneider Automation SAS. All Rights Reserved.					

NOTE: The background color for the **Processor Utilization** and **Module Utilization** values varies, depending upon the percentage of utilization. If utilization is:

- 90% to 100%—background color is RED
- 80% to 89.99%—background color is YELLOW
- 0% to 79.99%—background color is GRAY

To open this page:

Step	Action
1	Starting at the Home page , click the Diagnostics main menu item. The Diagnostics page opens.
2	On the left side of the Diagnostics page, select Ethernet → Processor Load .
3	If necessary, type in the HTTP web access password. NOTE: The default password is USER .

Processor Load Parameters

The **Processor Load** page displays the following parameters for the communication module:

Parameter	Description
Module Load:	
Processor Utilization	The percent of Ethernet communication module processor capacity used by the present level of communication activity. The background color of the value changes, depending on the percentage utilization.
I/O Scanner:	
EtherNet/IP Sent (writes)	The number of EtherNet/IP packets the module has sent, since the last reset, in packets/second.
EtherNet/IP Received (read)	The number of EtherNet/IP packets the module has received, since the last reset, in packets/second.
Modbus TCP Requests	The number of Modbus TCP requests the module has sent, since the last reset, in packets/second.
Modbus TCP Responses	The number of Modbus TCP responses the module has received, since the last reset, in packets/second.
I/O Adapter:	
EtherNet/IP Sent (writes)	The number of EtherNet/IP packets the module has sent—in the role of a local slave—since the last reset, in packets/second.
EtherNet/IP Received (read)	The number of EtherNet/IP packets the module has received—in the role of a local slave—since the last reset, in packets/second.
I/O - Module	
Module Capacity	The maximum number of packets that the module can process, in packets per second.
Module Utilization	The percentage of communication module capacity being used by the application. The background color of the value changes, depending on the percentage utilization.
Messaging - Client:	
EtherNet/IP activity	The number of I/O messages sent by the module—using the EtherNet/IP protocol—since last reset, in packets per second.
Modbus TCP activity	The number of I/O messages sent by the module—using the Modbus TCP protocol—since last reset, in packets per second.

Parameter	Description
Messaging - Server:	
EtherNet/IP activity	The number of I/O messages received by the module—using the EtherNet/IP protocol—since last reset, in packets per second.
Modbus TCP activity	The number of I/O messages received by the module—using the Modbus TCP protocol—since last reset, in packets per second.

Scanner Status

Introduction

The **Scanner Status** web page displays read-only data describing the current state of the BMX NOC 0401 Ethernet communication module in its role as I/O scanner.

Scanner Status Display

The top of the page displays the following general diagnostic information about the scanner:

- I/O scanning status
 - A value of **Operational** indicates that the values in the **Scanner Status** grid are reporting the state of scanned devices.
 - A value of **Stopped** indicates the local system is not scanning. In this case, any data that appears in the **Scanner Status** grid is meaningless.
- Number of transactions per second
- Number of connections

The **Scanner Status** web page looks like this:

Monitoring Control Diagnostics Maintenance Setup

SCANNER STATUS

Scanner status: **Operational**

Number of transactions per sec : **83** | Number of connections : **3**

Scanner Status			
16		EIP	1
32			17
48			33
64			49

Non-Configured Scanned Not Scanned Fault

Copyright © 1998-2007, Schneider Automation SAS. All Rights Reserved.

In the **Scanner Status** grid, the colors that appear in each block indicate the following states for specific remote devices:

- GREEN indicates that a device is being scanned
- BLACK indicates that I/O scanning of the specific device has been intentionally disabled
- GRAY indicates an device that is not configured
- RED indicates a suspect device

NOTE: A green **Scanner Status** indicator in the grid can remain green for a remote scanned device after the Ethernet cable is detached from that device. This situation can occur if the health timeout value for that device is set to 0.

To avoid this result—and to help promote the accurate reporting of I/O scanning health—configure an operational health timeout value in the range 1...65535 (in 1 ms increments).

The grid also indicates the protocol used to communicate with the remote device:

- MB: indicates a Modbus TCP connection
- EIP: indicates an EtherNet/IP connection

To open this page:

Step	Action
1	Starting at the Home page , click the Diagnostics main menu item. The Diagnostics page opens.
2	On the left side of the Diagnostics page, select Ethernet → Scanner Status .
3	If necessary, type in the HTTP web access password. NOTE: The default password is USER .

Messaging

Introduction

The **Messaging** page provides current information on the open TCP connections on port 502.

Messaging Display

The top of the page displays the number of messages sent and received by local port 502.

The **Messaging** page looks like this:

Monitoring	Control	Diagnostics	Maintenance	Setup			
MESSAGING DIAGNOSTIC							
Number of Messages sent : 94275 Number of Messages received : 95274							
Conn.	Remote address	Remote port	Local port	Type	Mess. Sent	Mess. Received	Error Sent
1	192.168.1.222	2568	502	Modbus TCP	3955	3954	0
2	192.168.1.6	1217	502	EtherNet/IP	2345	2344	0
3	192.168.1.7	1222	502	Modbus TCP	1357	1356	0

Copyright © 1998-2007, Schneider Automation SAS. All Rights Reserved.

The display grid provides the following information about each active connection:

- **Conn.:** the connection number—1 to 64
- **Remote address:** the IP address of the remote device
NOTE: If the remote device includes an embedded web server, click on the **Remote address** to open that server and view the remote device’s web pages.
- **Remote port:** the TCP port for the connection on the remote device
- **Local port:** the TCP port for the connection on the Ethernet communication module
- **Type:** the connection type—EtherNet/IP or Modbus TCP
- **Mess. Sent:** the number of messages transmitted over this connection
- **Mess. Received:** the number of messages received by this connection
- **Error Sent:** the number of events detected on this connection

NOTE:

- Following a request to close a connection, the PLC may hold the connection open in its memory for a few minutes, during which the display will reflect the open connection.
- The **Number of Messages received** is not reset after a port 502 connection is closed. Therefore, the count indicates the total number of messages that have been received since the module was started

To open this page:

Step	Action
1	Starting at the Home page , click the Diagnostics main menu item. The Diagnostics page opens.
2	On the left side of the Diagnostics page, select Ethernet → Messaging .
3	If necessary, type in the HTTP web access password. NOTE: The default password is USER .

QoS Configuration

Introduction

The BMX NOC 0401 Ethernet communication module supports the OSI layer 3 Quality of Service (QoS) standard defined in RFC-2475. When the QoS is enabled, the module adds a *differentiated services code point* (DSCP) tag to each Ethernet packet it transmits, thereby indicating the priority of that packet.

The **QoS Configuration** page displays both the:

- status of the QoS Ethernet packet tagging service—enabled or disabled, and
- the QoS service configuration settings

NOTE: The QoS service is enabled in the Services page (see *Quantum using EcoStruxure™ Control Expert, 140 NOC 771 01 Ethernet Communication Module, User Manual*), and the configuration settings are input in the QoS page (see *Quantum using EcoStruxure™ Control Expert, 140 NOC 771 01 Ethernet Communication Module, User Manual*), of the Control Expert Ethernet Configuration Tool.

QoS Configuration Display

The QoS Configuration page looks like this:

Monitoring	Control	Diagnostics	Maintenance	Setup
QoS CONFIGURATION				
QoS Configuration				
Status: <input type="text" value="Enabled"/>				
EtherNet/IP				
DSCP Value for IO Data Urgent Priority Messages				<input type="text" value="55"/>
DSCP Value for IO Data Schedule Priority Messages				<input type="text" value="47"/>
DSCP Value for IO Data High Priority Messages				<input type="text" value="43"/>
DSCP Value for IO Data Low Priority Messages				<input type="text" value="31"/>
DSCP Value for Explicit Message				<input type="text" value="27"/>
Modbus TCP				
DSCP Value for IO Messages				<input type="text" value="47"/>
DSCP Value for Explicit Message				<input type="text" value="27"/>
Network Time Service				
DSCP Value for Network Time Service				<input type="text" value="59"/>
Copyright © 2000-2009, Schneider Automation SAS. All Rights Reserved.				

This page is read-only.

To open this page:

Step	Action
1	Starting at the Home page , click the Diagnostics main menu item. The Diagnostics page opens.
2	On the left side of the Diagnostics page, select Ethernet → QoS Configuration .
3	If necessary, type in the HTTP web access password. NOTE: The default password is USER .

Port Statistics

Introduction

Use the **Port Statistics** page to display the following data for the BMX NOC 0401 Ethernet communication module:

- static IP addressing configuration data for the module, and
- dynamically generated data describing operations of the module's internal port, and each of the module's external Ethernet ports (ports 1, 2, 3 and 4)

Port Statistics Display

The **Port Statistics** page looks like this:

Monitoring	Control	Diagnostics	Maintenance	Setup	
PORT STATISTICS					
Ethernet configuration					
Hostname:	----	Subnet Mask:	255.255.255.0		
MAC Address:	bc fb 01 f4 80 00	Gateway:	0.0.0.0		
IP Address:	192.168.1.4				
Port Statistics					
	Internal port	port 1	port 2	port 3	port 4
Interface label:	Internal port	Port 1	Port 2	Port 3	Port 4
Speed (Operational):	N/A	100Mbps	100Mbps	10Mbps	10Mbps
Duplex (Operational):	N/A	TP-Full Link	TP-Full Link	TP-Half Link	TP-Half Link
Frames transmit OK:	0	0	0	0	0
Frames received OK:	181596	126354	73220	0	0
Collisions:	0	0	0	0	0
Excessive collisions:	0	0	0	0	0
Late collisions:	0	0	0	0	0
CRC errors:	0	0	0	0	0
Number Bytes Received:	15568790	5047683	704	0	0
Number Inbound Packets Error:	220	19185	73220	0	0
Number Inbound Packets Discard:	0	0	0	0	0
Number Bytes Sent:	203	203	203	203	203
Number Outbound Packets Error:	100	100	100	10	10
Number Outbound Packets Discard:	3	3	3	3	3
Reset counters					
Copyright © 1998-2008, Schneider Automation SAS. All Rights Reserved.					

Click on the **Reset counters** button to reset the counting statistics to zero.

To open this page:

Step	Action
1	Starting at the Home page , click the Diagnostics main menu item. The Diagnostics page opens.
2	On the left side of the Diagnostics page, select Ethernet → Switch → Port Statistics .
3	If necessary, type in the HTTP web access password. NOTE: The default password is USER .

Port Statistics Descriptions

The **Port Statistics** page displays the following parameters for each communication module port:

Parameter	Description
Ethernet Configuration data:	
Hostname	The name assigned to the communication module
MAC Address	The factory assigned Media Access Control (MAC) address, consisting of 6 hexadecimal octet values
IP Address	The Internet Protocol (IP) address (<i>see page 70</i>) that has been assigned to the communication module
Subnet Mask	The subnet mask (<i>see page 70</i>) that has been assigned to the communication module
Gateway	The IP address of the remote device (<i>see page 70</i>), if any, that serves as a gateway to the communication module
Port Statistics:	
Interface Label	Un-Initialized or Initialized
Speed (Operational)	Baud rate: 0, 10, 100 Mbps
Duplex (Operational)	Twisted Pair— Full Link, Twisted Pair—Half Link
Frames transmit OK:	The number of frames that have been successfully transmitted
Frames received OK:	The number of frames that have been successfully received
Collisions:	The number of times a collision between two successfully transmitted packets was detected on the link
Excessive collisions:	The number of times the transmitter has not been successful after 16 attempts to transmit a frame, due to repeated collisions
CRC errors:	The number of times a CRC (FCS) error was detected on an incoming frame
Number Bytes Received:	Number of inbound bytes received on the interface
Number Inbound Packets Error:	The number of inbound packets that contain detected errors (not included in discards)
Number Inbound Packets Discard:	The number of inbound packets received on the interface, but discarded

Parameter	Description
Number Bytes Sent:	The number of outbound bytes transmitted on the interface
Number Outbound Packets Error:	The number of outbound packets that contain detected errors (not included in discards)
Number Outbound Packets Discard:	The number of outbound packets discarded while attempting to send them

Redundancy

Introduction

Use the **Redundancy** page to enable and disable the Rapid Spanning Tree Protocol (RSTP) for switch ports 3 and 4.

NOTE: Because only switch ports 3 and 4 support RSTP redundancy, use ports 3 and 4 to connect the BMX NOC 0401 Ethernet communication module to the wider network, and ports 1 and 2 for connections to local devices.

The RSTP service creates a loop-free logical network path for Ethernet devices that are part of a topology that includes redundant physical paths, and automatically restores network communication—by activating redundant links—in the event the network experiences a service interruption.

Redundancy Display

The **Redundancy** page looks like this:

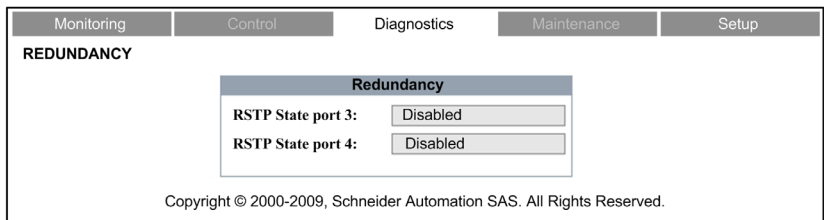

To open this page:

Step	Action
1	Starting at the Home page , click the Diagnostics main menu item. The Diagnostics page opens.
2	On the left side of the Diagnostics page, select Ethernet → Switch → Redundancy .
3	If necessary, type in the HTTP web access password. NOTE: The default password is USER .

Email Diagnostics

Diagnosing SMTP Transmissions

Use the **SMTP Diagnostics** web page to display dynamically generated data describing the BMX NOC 0401 Ethernet communication module Email transmissions.

NOTE: The Email service is enabled in the **Services** page, and the configuration settings are input in the **SMTP Configuration** page of the module DTM.

The **SMTP Diagnostics** web page looks like this:

Monitoring	Control	Diagnostics	Maintenance	Setup
EMAIL DIAGNOSTICS				
Email Service				
Status <input type="text" value="Operational"/>				
Email Server				
Status <input checked="" type="checkbox"/>				
IP Address <input type="text" value="192 . 168 . 1 . 10"/>				
Information of Last Email Header Used				
Sender Address <input type="text" value="Operator1@company.com"/>				
Recipient Address <input type="text" value="merle@mainoffice.com"/>				
Subject <input type="text" value="Pump #1 pumping mud, Merle, shut her down"/>				
Email Service Statistics				
Number of Emails Sent: <input type="text" value="2"/>				
Number of Responses from Email Server: <input type="text" value="25"/>				
Number of Errors: <input type="text" value="0"/>				
Last Error: <input type="text" value="16#0"/>				
Time elapses since last e-mail successfully sent (secs): <input type="text" value="23"/>				
Number of times link to the server down: <input type="text" value="0"/>				
<input type="button" value="Reset Counters"/>				
Copyright © 1998-2012, Schneider Electric. All Rights Reserved.				

Click the **Reset Counter** button to reset to 0 the **Email Service Statistics**.

To open this page:

Step	Action
1	Starting at the Home page , click the Diagnostics main menu item. The Diagnostics page opens.
2	On the left side of the Diagnostics page, select Ethernet → SMTP Diagnostics .
3	If necessary, type in the HTTP web access password. NOTE: The default password is USER .

Email diagnostic Parameters

Electronic mail notification service parameters include the following:

Parameter	Description
Email Service:	
Status	The status of this service in the Ethernet communication module: <ul style="list-style-type: none"> ● Operational ● Service Disabled
Email Server:	
Status	The connection status between Ethernet communication module and the SMTP server: <ul style="list-style-type: none"> ● check mark = connected ● no check mark = not connected NOTE: Status is checked at start-up and at least every 30 minutes after start-up.
IP Address	IP address of the SMTP server
Information of Last Email Header Used:	
Sender Address:	Content of the <i>From</i> field in the last used Email header
Recipient Address:	Content of the <i>To</i> field in the last used Email header
Subject:	Content of the <i>Subject</i> field in the last used Email header
Email Service Statistics:	
Number of Emails Sent	Total number of Emails sent and successfully acknowledged by the SMTP server.
Number of Responses from Email Server	Total number of responses received from the SMTP server
Number of Errors	Total number of Emails that either: <ul style="list-style-type: none"> ● could not be sent ● were sent but were not successfully acknowledged by the SMTP server
Last Error	Hexadecimal code describing the reason for the last unsuccessful Email transmission (<i>see page 433</i>). The value "0" indicates no unsuccessful transmissions.

Parameter	Description
Time elapses since last Email successfully sent (sec)	Counts the number of seconds since the last Email was successfully sent.
Number of times link to the server down	Number of times the SMTP server could not be reached. (Link checked every 30 minutes.)

Network Time Service Diagnostics

Diagnosing the Network Time Service

Use the **Network Time Service Diagnostic** web page to display dynamically generated data describing the operation of the network time protocol (NTP) service that you configured in the Network Time Service page (*see page 105*) in Control Expert.

NOTE: The Email service is enabled in the **Services** page, and the configuration settings are input in the **Network Time Service Configuration** page of the module DTM.

The **NTP Diagnostics** web page looks like this:

Monitoring	Control	Diagnostics	Maintenance	Setup
NETWORK TIME SERVICE DIAGNOSTICS				
Network Time Service				
Status: <input type="text" value="Operational"/>				
Date and Time Status				
Date: <input type="text" value="21-Oct-2011"/>		Time: <input type="text" value="14:22:13"/>		DST Status: <input type="text" value="ON"/>
Time Zone: <input type="text" value="UTC-5:00"/>				
NTP Server				
Status: <input checked="" type="checkbox"/>		IP Address: <input type="text" value="192 . 168 . 1 . 1"/>		Type: <input type="text" value="Primary"/>
Network Time Service Statistics				
Number of Requests: <input type="text" value="0"/>		Number of Errors: <input type="text" value="0"/>		
Number of Responses: <input type="text" value="0"/>		Last Error: <input type="text" value="16#0"/>		
<input type="button" value="Reset Counters"/>				
Copyright © 1998-2012, Schneider Electric. All Rights Reserved.				

Click the **Reset Counter** button to reset to 0 the **Network Time Service Statistics**.

To open this page:

Step	Action
1	Starting at the Home page , click the Diagnostics main menu item. The Diagnostics page opens.
2	On the left side of the Diagnostics page, select Ethernet → NTP Diagnostics .
3	If necessary, type in the HTTP web access password. NOTE: The default password is USER .

Network Time Service Diagnostic Parameters

Time synchronization service parameters are in the table:

Parameter	Description
Network Time Service:	
Status	Operational status of the service in the module: <ul style="list-style-type: none"> ● Operational ● Service Disabled
Date and Time Status:	
Date:	System date
Time:	System time NOTE: Red text indicates the network time server is not available.
DST Status	The actual working status of the automatic daylight savings service: <ul style="list-style-type: none"> ● ON = automatic adjustment of daylight savings is enabled and the current date and time reflect the daylight savings time adjustment ● OFF = automatic adjustment of daylight savings is disabled; or automatic adjustment of daylight savings is enabled, but the current date and time may not reflect the daylight savings time adjustment
Time Zone	Time zone plus or minus Universal Time, Coordinated (UTC)
NTP Server:	
Status	Connection status of the NTP server: <ul style="list-style-type: none"> ● check mark = the NTP server is reachable ● no check mark = the NTP server is not reachable
IP Address	The IP address of the NTP server
Type	The NTP server currently active: <ul style="list-style-type: none"> ● Primary ● Secondary
Network Time Service Statistics:	
Number of Requests:	Total number of client requests sent to the NTP server
Number of Responses:	Total number of server responses sent from the NTP server
Number of Errors:	Total number of unanswered NTP requests
Last Error	Last detected error code received from the NTP client: <ul style="list-style-type: none"> ● 0: good NTP configuration ● 1: late NTP server response (can be caused by excessive network traffic or server overload) ● 2: NTP not configured ● 3: invalid NTP parameter setting ● 4: NTP component disabled ● 7: unrecoverable NTP transmission ● 9: invalid NTP server IP address ● 15: invalid syntax in the custom time zone rules file

Properties

Introduction

The **Properties** web page displays read-only data describing the particular BMX NOC 0401 Ethernet communication module installed in your system.

Properties Display

The **Properties** page looks like this:

The screenshot shows a web interface with a navigation bar at the top containing five tabs: Monitoring, Control, Diagnostics, Maintenance, and Setup. The 'Diagnostics' tab is active. Below the navigation bar, the word 'PROPERTIES' is displayed. A central box titled 'Properties' contains the following information:

- Device type: 12
- Product code: 2052
- Product name: BMX NOC 0401
- Revision: 1.01
- Serial number: 134347887
- Status: 100
- Vendor name: 243

At the bottom of the page, the copyright notice reads: Copyright © 2000-2009, Schneider Automation SAS. All Rights Reserved.

To open this page:

Step	Action
1	Starting at the Home page , click the Diagnostics main menu item. The Diagnostics page opens.
2	On the left side of the Diagnostics page, select Properties .
3	If necessary, type in the HTTP web access password. NOTE: The default password is USER .

Appendices



What Is in This Appendix?

The appendix contains the following chapters:

Chapter	Chapter Name	Page
A	Detected Error Codes	419
B	CIP General Status Codes	427
C	Modbus Exception Response Codes	431
D	Email Detected Error Response Codes	433

Appendix A

Detected Error Codes

Overview

This chapter contains a list of codes that describe the status of Ethernet communication module messages.

What Is in This Chapter?

This chapter contains the following topics:

Topic	Page
EtherNet/IP Implicit or Explicit Messaging Detected Error Codes	420
Explicit Messaging: Communication and Operation Reports	423

EtherNet/IP Implicit or Explicit Messaging Detected Error Codes

Introduction

If a DATA_EXCH function block does not execute an EtherNet/IP explicit message, Control Expert returns a hexadecimal detected error code. The code can describe an EtherNet/IP detected error.

EtherNet/IP Detected Error Codes

EtherNet/IP hexadecimal detected error codes include:

Detected Error Code	Description
16#800D	Timeout on the explicit message request
16#8012	Bad device
16#8015	Either: <ul style="list-style-type: none"> • Nor resources to handle the message, or • Internal detected error: no buffer available, no link available, impossible to send to the TCP task
16#8018	Either: <ul style="list-style-type: none"> • Another explicit message for this device is in progress, or • TCP connection or encapsulation session in progress
16#8030	Timeout on the Forward_Open request
Note: The following 16#81xx detected errors are Forward_Open response detected errors that originate at the remote target and are received via the CIP connection.	
16#8100	Connection in use or duplicate Forward_Open
16#8103	Transport class and trigger combination not supported
16#8106	Ownership conflict
16#8107	Target connection not found
16#8108	Invalid network connection parameter
16#8109	Invalid connection size
16#8110	Target for connection not configured
16#8111	RPI not supported
16#8113	Out of connections
16#8114	Vendor ID or product code mismatch
16#8115	Product type mismatch
16#8116	Revision mismatch
16#8117	Invalid produced or consumed application path
16#8118	Invalid or inconsistent configuration application path
16#8119	Non-Listen Only connection not opened

Detected Error Code	Description
16#811A	Target object out of connections
16#811B	RPI is smaller than the production inhibit time
16#8123	Connection timed out
16#8124	Unconnected request timed out
16#8125	Parameter detected error in unconnected request and service
16#8126	Message too large for unconnected_send service
16#8127	Unconnected acknowledge without reply
16#8131	No buffer memory available
16#8132	Network bandwidth not available for data
16#8133	No consumed connection ID filter available
16#8134	Not configured to send scheduled priority data
16#8135	Schedule signature mismatch
16#8136	Schedule signature validation not possible
16#8141	Port not available
16#8142	Link address not valid
16#8145	Invalid segment in connection path
16#8146	Detected error in Forward_Close service connection path
16#8147	Scheduling not specified
16#8148	Link address to self invalid
16#8149	Secondary resources unavailable
16#814A	Rack connection already established
16#814B	Module connection already established
16#814C	Miscellaneous
16#814D	Redundant connection mismatch
16#814E	No more user-configurable link consumer resources: the configured number of resources for a producing application has reached the limit
16#814F	No more user-configurable link consumer resources: there are no consumers configured for a producing application to use
16#8160	Vendor specific
16#8170	No target application data available
16#8171	No originator application data available
16#8173	Not configured for off-subnet multicast
16#81A0	Detected error in data assignment
16#81B0	Optional object state detected error

Detected Error Code	Description
16#81C0	Optional device state detected error
Note: All 16#82xx detected errors are register session response detected errors.	
16#8200	Target device does not have sufficient resources
16#8208	Target device does not recognize message encapsulation header
16#820F	Reserved or unknown detected error from target

Explicit Messaging: Communication and Operation Reports

Overview

Communication and operation reports are part of the management parameters.

NOTE: It is recommended that communication function reports be tested at the end of their execution and before the next activation. On cold start-up, confirm that all communication function management parameters are checked and reset to 0.

It may be helpful to use the %S21 to examine the first cycle after a cold or warm start.

Communication Report

This report is common to every explicit messaging function. It is significant when the value of the activity bit switches from 1 to 0. The reports with a value between 16#01 and 16#FE concern errors detected by the processor that executed the function.

The different values of this report are indicated in the following table:

Value	Communication report (least significant byte)
16#00	Correct exchange
16#01	Exchange stop on timeout
16#02	Exchange stop on user request (CANCEL)
16#03	Incorrect address format
16#04	Incorrect destination address
16#05	Incorrect management parameter format
16#06	Incorrect specific parameters
16#07	Error detected in sending to the destination
16#08	Reserved
16#09	Insufficient receive buffer size
16#0A	Insufficient send buffer size
16#0B	No system resources: the number of simultaneous communication EFs exceeds the maximum that can be managed by the processor
16#0C	Incorrect exchange number
16#0D	No telegram received
16#0E	Incorrect length
16#0F	Telegram service not configured
16#10	Network module missing
16#11	Request missing
16#12	Application server already active

Value	Communication report (least significant byte)
16#13	UNI-TE V2 transaction number incorrect
16#FF	Message refused

NOTE: The function can detect a parameter error before activating the exchange. In this case the activity bit remains at 0, and the report is initialized with values corresponding to the detected error.

Operation Report

This report byte is specific to each function, and specifies the result of the operation on the remote application:

Value	Operation report (most significant byte)
16#05	Length mismatch (CIP)
16#07	Bad IP address
16#08	Application error
16#09	Network is down
16#0A	Connection reset by peer
16#0C	Communication function not active
16#0D	<ul style="list-style-type: none"> ● Modbus TCP: transaction timed out ● EtherNet/IP: request timeout
16#0F	No route to remote host
16#13	Connection refused
16#15	<ul style="list-style-type: none"> ● Modbus TCP: no resources ● EtherNet/IP: no resources to handle the message; or an internal detected error; or no buffer available; or no link available; or cannot send message
16#16	Remote address not allowed
16#18	<ul style="list-style-type: none"> ● Modbus TCP: concurrent connections or transactions limit reached ● EtherNet/IP: TCP connection or encapsulation session in progress
16#19	Connection timed out
16#22	Modbus TCP: invalid response
16#23	Modbus TCP: invalid device ID response
16#30	<ul style="list-style-type: none"> ● Modbus TCP: remote host is down ● EtherNet/IP: connection open timed out
16#80...16#87: Forward_Open response detected errors:	
16#80	Internal detected error
16#81	Configuration detected error: the length of the explicit message, or the RPI rate, needs to be adjusted
16#82	Device detected error: target device does not support this service

Value	Operation report (most significant byte)
16#83	Device resource detected error: no resource is available to open the connection
16#84	System resource event: unable to reach the device
16#85	Data sheet detected error: incorrect EDS file
16#86	Invalid connection size
16#90...16#9F	Register session response detected errors:
16#90	Target device does not have sufficient resources
16#98	Target device does not recognize message encapsulation header
16#9F	Unknown detected error from target

Appendix B

CIP General Status Codes

CIP General Status Codes

NOTE: Taken by permission from *The CIP Networks Library, Volume 1, Common Industrial Protocol (CIP™)*, Edition 3.6, April 2009.

The following table lists the status codes that may be present in the general status code field of a detected error response message. Note that the extended code field is available for use in further describing any general status code. Extended status codes are unique to each general status code within each object. Each object manages the extended status values and value ranges (including vendor specific). All extended status values are reserved unless otherwise indicated within the object definition.

General Status Code (in hex)	Status Name	Description of Status
00	Success	Service was successfully performed by the object specified.
01	Connection unsuccessful	A connection related service was unsuccessful along the connection path.
02	Resource unavailable	Resources needed for the object to perform the requested service were unavailable.
03	Invalid parameter value	See status code 0x20, which is the preferred value to use for this condition.
04	Path segment error	The path segment identifier or the segment syntax was not understood by the processing node. Path processing stops when a path segment error is detected.
05	Path destination unknown	The path is referencing an object class, instance, or structure element that is not known or is not contained in the processing node. Path processing stops when a path destination unknown error is detected.
06	Partial transfer	Only part of the expected data was transferred.
07	Connection lost	The messaging connection was lost.
08	Service not supported	The requested service was not implemented or was not defined for this object class/instance.
09	Invalid attribute value	Invalid attribute data detected.
0A	Attribute list error	An attribute in the Get_Attribute_List or Set_Attribute_List response has a non-zero status.

General Status Code (in hex)	Status Name	Description of Status
0B	Already in requested mode/state	The object is already in the mode/state being requested by the service.
0C	Object state conflict	The object cannot perform the requested service in its current mode/state.
0D	Object already exists	The requested instance of object to be created already exists.
0E	Attribute not settable	A request to modify a non-modifiable attribute was received.
0F	Privilege violation	A permission/privilege check was unsuccessful.
10	Device state conflict	The device's current mode/state prohibits the execution of the requested service.
11	Reply data too large	The data to be transmitted in the response buffer is larger than the allocated response buffer.
12	Fragmentation of a primitive value	The service specified an operation that is going to fragment a primitive data value, i.e., half a REAL data type.
13	Not enough data	The service did not supply enough data to perform the specified operation.
14	Attribute not supported	The attribute specified in the request is not supported.
15	Too much data	The service supplied more data than was expected.
16	Object does not exist	The object specified does not exist in the device.
17	Service fragmentation sequence not in progress	The fragmentation sequence for this service is not currently active for this data.
18	No stored attribute data	The attribute data of this object was not saved prior to the requested service.
19	Store operation unsuccessful	The attribute data of this object was not saved due to an unsuccessful attempt.
1A	Routing unsuccessful, request packet too large	The service request package was too large for transmission on a network in the path to the destination. The routing device was forced to abort the service.
1B	Routing unsuccessful, response packet too large	The service response packet was too large for transmission on a network in the path from the destination. The routing device was forced to abort the service.
1C	Missing attribute list entry data	The service did not supply an attribute in a list of attributes that was needed by the service to perform the requested behavior.
1D	Invalid attribute value list	The service is returning the list of attributes supplied with status information for those attributes that were invalid.
1E	Embedded service error	An embedded service resulted in a detected error.

General Status Code (in hex)	Status Name	Description of Status
1F	Vendor specific error	A vendor specific error has been detected. The additional code field of the error response defines the particular error encountered. Use this general code only when none of the codes presented in this table or within an object class definition accurately reflect the detected error.
20	Invalid parameter	A parameter associated with the request was invalid. This code is used when a parameter does not meet the requirements of this specification and/or the requirements defined in an application object specification.
21	Write-once value or medium already written	An attempt was made to write to a write-once medium (e.g., WORM drive, PROM) that has already been written, or to modify a value that cannot be changed once established.
22	Invalid reply received	An invalid reply is received (e.g., reply service code does not match the request service code, or reply message is shorter than the minimum expected reply size). This status code can serve for other causes of invalid replies.
23	Buffer overflow	The message received is larger than the receiving buffer can handle. The entire message was discarded.
24	Message format error	The format of the received message is not supported by the server.
25	Key failure in path	The key segment that was included as the first segment in the path does not match the destination module. The object specific status indicates which part of the key check was unsuccessful.
26	Path size invalid	The size of the path that was sent with the service request is either not large enough to allow the request to be routed to an object or too much routing data was included.
27	Unexpected attribute in list	An attempt was made to set an attribute that is not able to be set at this time.
28	Invalid member ID	The member ID specified in the request does not exist in the specified class/instance/attribute.
29	Member not settable	A request to modify a non-modifiable member was received.
2A	Group 2 only server — general error	This detected error code may only be reported by DeviceNet group 2 only servers with 4 Kb or less code space and only in place of service not supported, attribute not support, or attribute not settable.
2B	Unknown Modbus error	A CIP to Modbus translator received an unknown Modbus exception code.
2C	Attribute not gettable	A request to read a non-readable attribute was received.
2D - CF	–	Reserved by CIP for future extensions.
D0 - FF	Reserved for object class and service errors	This range of detected error codes is used to indicate object class specific detected errors. Use this range only when none of the codes presented in this table accurately reflect the error that is detected.

Appendix C

Modbus Exception Response Codes

MODBUS Exception Response Codes

The MODBUS exception response codes include the following:

Status		Response	Description
Hex)	(Dec)		
0x8101	33025	Illegal Function	The function code received in the query is not an allowable action for the server (or slave). This may be because the function code is only applicable to newer devices, and was not implemented in the unit selected. It could also indicate that the server (or slave) is in the wrong state to process a request of this type. This code is also returned when attempting to write to a read-only attribute.
0x8102	33026	Illegal Data Address	The data address received in the query is not an allowable address for the server (or slave). More specifically, the combination of reference number and transfer length is invalid.
0x8103	33027	Illegal Data Value	A value contained in the query data field is not an allowable value for server (or slave). This indicates an invalid request structure. It specifically does NOT mean that a data item submitted for storage in a register has a value outside the expectation of the application program, because the MODBUS protocol does not test the significance of any particular register value.
0x8104	33028	Slave Device Failure	An unrecoverable event occurred while the server (or slave) was attempting to perform the requested action.
0x8105	33029	Acknowledge	Specialized use in conjunction with programming commands: The server (or slave) has accepted the request and is processing it, but a long duration of time will be required to do so. This response is returned so that a timeout in the client (or master) will not occur. The client (or master) can next send a Poll Program Complete message to determine if processing is completed.
0x8106	33030	Slave Device Busy	Specialized use in conjunction with programming commands: The server (or slave) is engaged in processing a long-duration program command. The client (or master) should retransmit the message later when the server (or slave) is free.
0x8107	33031	Negative Acknowledge	Specialized use in conjunction with programming commands: The request attempts to initiate a program function that is not supported by the server (slave).

Status		Response	Description
Hex)	(Dec)		
0x8108	33032	Memory Parity Error	Specialized use in conjunction with function codes 20 and 21 and reference type 6, indicating that the extended file area did not pass a consistency check.
0x810A	33034	Gateway Path Unavailable	Specialized use in conjunction with gateways, indicates that the gateway was unable to allocate an internal communication path from the input port to the output port for processing the request. Usually means that the gateway is misconfigured or overloaded.
0x810B	33035	Gateway Target Device Failed to Respond	Specialized use in conjunction with gateways, indicates that no response was obtained from the target device. Usually means that the device is not present on the network.

The preceding MODBUS exception response codes are derived from the *MODBUS Application Protocol Specification V1.1b* as distributed by the Modbus Organization, Inc. at <http://www.Modbus-IDA.com>.

Appendix D

Email Detected Error Response Codes

Electronic Mail Notification Service Detected Error Response Codes

SMTP Codes

The following codes are available only on the Control Expert DTM and web page diagnostic screens for the electronic mail notification service:

Code (hexadecimal)	Description
16#5100	Internal error detected
16#5101	SMTP component not operational
16#5102	Mail header not configured
16#5103	Invalid mail header value detected (1, 2, or 3)
16#5104	Cannot connect to SMTP server
16#5105	Error detected during transmitting content of email body to SMTP server
16#5106	Closing SMTP connection with the server returned a detected error message
16#5107	SMTP HELO request unsuccessful
16#5108	SMTP MAIL request unsuccessful — SMTP server may require authentication
16#5109	SMTP RCPT request unsuccessful
16#510A	No recipient accepted by the SMTP server
16#510B	SMTP DATA request unsuccessful
16#510C	Send email request contains an invalid length
16#510D	Authentication unsuccessful
16#510E	A reset component request was received while the connection was open



R

RPI

(requested packet interval) The time period between cyclic data transmissions requested by the Scanner. EtherNet/IP devices will publish data at the rate specified by the RPI assigned to them by the Scanner. Modbus TCP devices will receive message requests from the Scanner at each RPI.

T

trap

A trap is an event directed by an SNMP agent that indicates either:

- a change has occurred in the status of an agent, or
- an unauthorized SNMP manager device has attempted to get data from, or change data on, an SNMP agent



0-9

- 140 NOC 780 00
 - device editor, *57*
 - DTM browser, *45*

A

- access control, *89*
- add remote device, *138, 173*
- address
 - I/O, *202*
- advanced mode
 - DTM browser, *50*
- Advantys STB island
 - connecting to, *152, 183*
- assembly object, *247, 251*
- auto-negotiation, *216*

B

- Bandwidth Diagnostics, *336*

C

- certifications, *19*
- channel properties, *63*
- CIP objects, *243*
- code 3
 - diagnostics, *312*
- configuring
 - properties in device editor, *57*
- connection
 - diagnostics, *347*
 - I/O, *351*
 - overhead, *228*
 - protocol, *228*
 - type, *228*
- connection manager object, *249*
- connection timeout
 - calculating, *227*

- control bits, *205*
- Control Expert
 - create project, *33*
 - download application, *59*
 - upload application, *61*

D

- data editor
 - creating a data template, *385*
 - direct address, *387*
 - lite, *389*
 - modify data, *388*
 - saving a data template, *386*
- data editor (standard), *380*
- data template
 - displaying a data template, *387*
- DATA_EXCH, *298, 302, 306, 314*
 - error codes, *420*
 - explicit message, *289*
- derived data types, *198, 200*
- derived variables, *201*
- device bandwidth, *235*
- device discovery, *51*
- device editor, *55*
 - DTM browser, *57*
- device load, *235*
- DHCP, *80*
- DHCP client, *83*

diagnostics, *329*
 bandwidth, *336, 398*
 connection, *347*
 Email, *339, 411*
 Ethernet port, *332*
 function code 3, *312*
 local slave, *347*
 messaging, *403*
 NTP, *341, 414*
 port statistics, *407*
 processor load, *398*
 properties, *416*
 QoS, *405*
 rack viewer, *396*
 redundancy, *410*
 RSTP, *344*
 scanner status, *401*
 status summary, *393*
diagnostics web page, *392*
download, *59*
DSCP, *67*
DTM
 add, *127*
DTM Browser, *42*
DTM browser
 advanced mode, *50*
 configuring properties in device editor, *57*
DTM browser menu commands, *45*

E

EDS file
 add, *128*
 remove, *133*
Email
 configuring, *100*
 diagnostics, *339, 411*
Ethernet
 connection speed, *65*
Ethernet diagnostics, *332*
ethernet link object, *257*
EtherNet/IP explicit connection diagnostics
object, *271, 273*
EtherNet/IP interface diagnostics object, *262*
EtherNet/IP IO Scanner Diagnostics object,

265
EtherNet/IP settings, *75*
explicit message, *225, 289*
 EtherNet/IP, *320*
 Get_Attribute_Single, *298*
 Modbus TCP, *323*
 Read Modbus Object, *302*
 read register, *314*
 Write Modbus Object, *306*
explicit messaging
 communication report, *423*
 error codes, *420*
 Modbus TCP function codes, *311*
 operation report, *423*

F

FDR, *80*
field bus discovery, *51*
full-duplex, *216*
function code 3 diagnostics
 unit id=255, *312*

H

hardware catalog
 updating, *131*
health bits, *203*
home web page, *372*

I

I/O
 connection, *351*
 local slave, *351*
identity object, *245*
IGMP snooping, *218*
implicit message, *226*
inputs
 address, *202*
IO connection diagnostics object, *267*
IP address, *70*

L

LEDs, *326*
load
 example, *238*
 limits, *231*
local slave, *111*
 configuring, *113*
 diagnostics, *347*
 I/O, *118, 351*
logging, *353*

M

menu commands
 DTM browser, *45*
message
 priority, *230*
message bandwidth, *234*
message frequency, *232*
message load, *234*
message response time, *237*
message traverse time, *236*
messages
 types, *225*
messaging, *403*
monitoring web page, *379*
mounting, *24*

N

network
 example, *30*
network bandwidth, *235*
network example, *136, 171*
network load, *235*
network time service, *105*
NTP
 diagnostics, *341, 414*

O

online action
 CIP object, *278*
 display CIP object data, *279*
 get port configuration, *281*
 ping, *282*
 port configuration, *280*
 reset, *279*
 set port configuration, *281*
online parameters, *284*
outputs
 address, *202*

P

password
 data editor write, *374*
 web page access, *374*
 web pages, *373*
physical description, *16*
ping, *282*
port diagnostics, *332*
port mirroring, *222*
 web pages, *376*
port statistics, *407*
processor load, *398*

Q

QoS, *67, 92, 217, 230, 405*
QoS object, *253*

R

rack viewer, *396*
redundancy, *410*
remote device
 configuring, *140, 175*
replacement, *367*
RSTP, *96, 219*
RSTP Diagnostics, *344*

S

- scanner status, *401*
- SEND_EMAIL, *103*
- services
 - enabling, *78*
- SMTP codes, *433*
- SNMP agent, *86, 223*
- specifications, *20*
 - communication, *22*
- standards, *19*
- status summary, *393*
- STB NIC 2212
 - configuring I/O items, *156*
- STB NIP 2212
 - configuring I/O items, *187*
- switch
 - managed, *215*
 - recommended features, *215*

T

- TCP/IP interface object, *255*
- timeout
 - connection, *227*

U

- uninstall, *28*
- unit ID
 - 255, function code 3 diagnostics, *312*
- upload, *61*
- username, *374*

V

- variables
 - derived, *201*
- VLAN, *220*

W

- web pages
 - data editor (standard), *380*
 - diagnostics, *392*
 - home, *372*
 - messaging, *403*
 - monitoring, *379*
 - password, *373*
 - port mirroring, *376*
 - port statistics, *407*
 - processor load, *398*
 - properties, *416*
 - QoS, *405*
 - rack viewer, *396*
 - redundancy, *410*
 - scanner status, *401*
 - status summary, *393*
- wiring, *25*