



### Main

Device short name	ATV212
Product destination	Asynchronous motors
Phase	3 phase
Motor power kW	18.5 kW
Maximum Horse Power Rating	25 hp
Supply voltage limits	170...264 V
Supply frequency	50...60 Hz - 5...5 %
Line current	55.8 A 240 V 67.3 A 200 V
Range of Product	Altivar 212
Product or Component Type	Variable speed drive
Product Specific Application	Pumps and fans in HVAC
Communication Port Protocol	METASYS N2 Modbus BACnet LonWorks APOGEE FLN
[Us] rated supply voltage	200...240 V - 15...10 %
EMC filter	Without EMC filter
IP degree of protection	IP21

### Complementary

Apparent power	28.5 kVA 240 V
Continuous output current	74.8 A 230 V
Maximum transient current	82.3 A 60 s
Speed drive output frequency	0.5...200 Hz
Speed range	1...10
Speed accuracy	+/- 10 % of nominal slip 0.2 Tn to Tn
Local signalling	For DC bus energized 1 LED (red)
Output voltage	<= power supply voltage
Isolation	Electrical between power and control
Type of cable	Without mounting kit 1 IEC cable 113 °F (45 °C), copper 90 °C / XLPE/EPR Without mounting kit 1 IEC cable 113 °F (45 °C), copper 70 °C / PVC With UL Type 1 kit 3 UL 508 cable 104 °F (40 °C), copper 75 °C / PVC
Electrical connection	VIA, VIB, FM, FLA, FLB, FLC, RY, RC, F, R, RES terminal 0.00 in <sup>2</sup> (2.5 mm <sup>2</sup> ) / AWG 14 L1/R, L2/S, L3/T terminal 0.04 in <sup>2</sup> (25 mm <sup>2</sup> ) / AWG 3
Tightening torque	5.31 Lbf.in (0.6 N.m) VIA, VIB, FM, FLA, FLB, FLC, RY, RC, F, R, RES) 39.83 lbf.in (4.5 N.m), 40 lb.in L1/R, L2/S, L3/T)
Supply	Internal supply for reference potentiometer (1 to 10 kOhm) 10.5 V DC +/- 5 %, <10 A overload and short-circuit protection Internal supply 24 V DC 21...27 V), <200 A overload and short-circuit protection
Sampling duration	2 Ms +/- 0.5 ms F discrete 2 Ms +/- 0.5 ms R discrete 2 Ms +/- 0.5 ms RES discrete 3.5 Ms +/- 0.5 ms VIA analog 22 ms +/- 0.5 ms VIB analog

The information provided in this documentation contains general descriptions and/or technical characteristics of the performance of the products contained herein. This documentation is not intended as a substitute for and is not to be used for determining suitability or reliability of these products for specific user applications. It is the duty of any such user or integrator to perform the appropriate and complete risk analysis, evaluation and testing of the products with respect to the relevant specific application or use thereof. Neither Schneider Electric Industries SAS nor any of its affiliates or subsidiaries shall be responsible or liable for misuse of the information contained herein.

Response time	FM 2 ms +/- 0.5 ms analog FLA, FLC 7 ms +/- 0.5 ms discrete FLB, FLC 7 ms +/- 0.5 ms discrete RY, RC 7 ms +/- 0.5 ms discrete
Accuracy	+/- 0.6 % (VIA) for a temperature variation 60 °C +/- 0.6 % (VIB) for a temperature variation 60 °C +/- 1 % (FM) for a temperature variation 60 °C
Linearity error	VIA +/- 0.15 % of maximum value input VIB +/- 0.15 % of maximum value input FM +/- 0.2 % output
Analogue output type	FM switch-configurable voltage 0...10 V DC 7620 Ohm 10 bits FM switch-configurable current 0...20 mA 970 Ohm 10 bits
Discrete output type	Configurable relay logic FLA, FLC) NO - 100000 cycles Configurable relay logic FLB, FLC) NC - 100000 cycles Configurable relay logic RY, RC) NO - 100000 cycles
Minimum switching current	3 mA 24 V DC configurable relay logic
Maximum switching current	5 A 250 V AC resistive cos phi = 1 L/R = 0 ms FL, R) 5 A 30 V DC resistive cos phi = 1 L/R = 0 ms FL, R) 2 A 250 V AC inductive cos phi = 0.4 L/R = 7 ms FL, R) 2 A 30 V DC inductive cos phi = 0.4 L/R = 7 ms FL, R)
Discrete input type	F programmable 24 V DC level 1 PLC 4700 Ohm R programmable 24 V DC level 1 PLC 4700 Ohm RES programmable 24 V DC level 1 PLC 4700 Ohm
Discrete input logic	Positive logic (source) F, R, RES), <= 5 V, >= 11 V Negative logic (sink) F, R, RES), >= 16 V, <= 10 V
Dielectric strength	2830 V DC between earth and power terminals 4230 V DC between control and power terminals
Insulation resistance	>= 1 mOhm 500 V DC for 1 minute
Frequency resolution	Display unit 0.1 Hz Analog input 0.024/50 Hz
Communication Service	Write multiple registers (16) 2 words maximum Read holding registers (03) 2 words maximum Read device identification (43) Monitoring inhibitible Time out setting from 0.1 to 100 s Write single register (06)
Option card	Communication card LonWorks
Power dissipation in W	698 W
Air flow	63138.25 Gal/hr(US) (239 m3/h)
Specific application	HVAC
Variable speed drive application selection	Building - HVAC compressor for scroll Building - HVAC fan Building - HVAC pump
Motor power range AC-3	15...25 kW 200...240 V 3 phase
Motor starter type	Variable speed drive
Discrete output number	2
Analogue input number	2
Analogue input type	VIA switch-configurable voltage 0...10 V DC 24 V max 30000 Ohm 10 bits VIB configurable voltage 0...10 V DC 24 V max 30000 Ohm 10 bits VIB configurable PTC probe 0...6 probes 1500 Ohm VIA switch-configurable current 0...20 mA 250 Ohm 10 bits
Analogue output number	1
Physical interface	2-wire RS 485
Connector Type	1 RJ45 1 open style
Transmission Rate	9600 bps or 19200 bps
Transmission frame	RTU
Number of addresses	1...247
Data format	8 bits, 1 stop, odd even or no configurable parity
Type of polarization	No impedance
Asynchronous motor control profile	Voltage/Frequency ratio, 5 points Voltage/Frequency ratio, automatic IR compensation (U/f + automatic Uo) Voltage/Frequency ratio - Energy Saving, quadratic U/f Flux vector control without sensor, standard Voltage/frequency ratio, 2 points
Torque accuracy	+/- 15 %

Transient overtorque	120 % of nominal motor torque +/- 10 % 60 s
Acceleration and deceleration ramps	Automatic based on the load Linear adjustable separately from 0.01 to 3200 s
Motor slip compensation	Not available in voltage/frequency ratio motor control Automatic whatever the load Adjustable
Switching frequency	6...16 kHz adjustable 8...16 kHz with derating factor
Nominal switching frequency	8 kHz
Braking to standstill	By DC injection
Network Frequency	47.5...63 Hz
Prospective line I <sub>sc</sub>	22 kA
Protection type	Overheating protection drive Thermal power stage drive Short-circuit between motor phases drive Input phase breaks drive Overcurrent between output phases and earth drive Overvoltages on the DC bus drive Break on the control circuit drive Against exceeding limit speed drive Line supply overvoltage and undervoltage drive Line supply undervoltage drive Against input phase loss drive Thermal protection motor Motor phase break motor With PTC probes motor
Width	9.65 in (245 mm)
Height	12.99 in (330 mm)
Depth	7.48 in (190 mm)
Net Weight	25.46 lb(US) (11.55 kg)

## Environment

Pollution degree	2 IEC 61800-5-1
IP degree of protection	IP20 on upper part without blanking plate on cover EN/IEC 61800-5-1 IP20 on upper part without blanking plate on cover EN/IEC 60529 IP21 EN/IEC 61800-5-1 IP21 EN/IEC 60529 IP41 on upper part EN/IEC 61800-5-1 IP41 on upper part EN/IEC 60529
Vibration resistance	1.5 mm 3...13 Hz)EN/IEC 60068-2-6 1 gn 13...200 Hz)EN/IEC 60068-2-8
Shock resistance	15 gn 11 ms IEC 60068-2-27
Environmental characteristic	Classes 3C1 IEC 60721-3-3 Classes 3S2 IEC 60721-3-3
Noise level	54 dB 86/188/EEC
Operating altitude	3280.84...9842.52 ft (1000...3000 m) limited to 2000 m for the Corner Grounded distribution network with current derating 1 % per 100 m <= 3280.84 ft (1000 m) without derating
Relative humidity	5...95 % without condensation IEC 60068-2-3 5...95 % without dripping water IEC 60068-2-3
Ambient air temperature for operation	14...104 °F (-10...40 °C) without derating) 104...122 °F (40...50 °C) with derating factor)
Operating position	Vertical +/- 10 degree
Product Certifications	C-tick CSA NOM 117 UL
Marking	CE

Standards	IEC 61800-3 environments 2 category C3 UL Type 1 EN 61800-3 environments 2 category C3 EN 61800-3 environments 2 category C2 EN 61800-5-1 EN 61800-3 environments 2 category C1 EN 61800-3 IEC 61800-3 environments 1 category C3 EN 61800-3 environments 1 category C1 IEC 61800-3 environments 1 category C2 IEC 61800-3 environments 2 category C2 EN 61800-3 environments 1 category C3 IEC 61800-3 environments 2 category C1 IEC 61800-5-1 IEC 61800-3 environments 1 category C1 IEC 61800-3 EN 61800-3 environments 1 category C2
Assembly style	With heat sink
Electromagnetic compatibility	Electrostatic discharge immunity test level 3 IEC 61000-4-2 Radiated radio-frequency electromagnetic field immunity test level 3 IEC 61000-4-3 Electrical fast transient/burst immunity test level 4 IEC 61000-4-4 1.2/50 µs - 8/20 µs surge immunity test level 3 IEC 61000-4-5 Conducted radio-frequency immunity test level 3 IEC 61000-4-6 Voltage dips and interruptions immunity test IEC 61000-4-11
Regulation loop	Adjustable PI regulator
Ambient Air Temperature for Storage	-13...158 °F (-25...70 °C)

## Ordering and shipping details

Category	22155-ATV212 1 - 25 HP 230 VOLT
Discount Schedule	CP4D
GTIN	3606480322419
Returnability	Yes
Country of origin	ID

## Packing Units

Unit Type of Package 1	PCE
Number of Units in Package 1	1
Package 1 Height	11.02 in (28 cm)
Package 1 Width	15.35 in (39 cm)
Package 1 Length	11.81 in (30 cm)
Package 1 Weight	24.96 lb(US) (11.32 kg)
Unit Type of Package 2	P06
Number of Units in Package 2	4
Package 2 Height	29.53 in (75 cm)
Package 2 Width	23.62 in (60 cm)
Package 2 Length	31.50 in (80 cm)
Package 2 Weight	118.61 lb(US) (53.8 kg)

## Offer Sustainability

Sustainable offer status	Green Premium product
California proposition 65	WARNING: This product can expose you to chemicals including: Lead and lead compounds, which is known to the State of California to cause cancer and birth defects or other reproductive harm. For more information go to <a href="http://www.P65Warnings.ca.gov">www.P65Warnings.ca.gov</a>
REACH Regulation	<a href="#">REACH Declaration</a>
EU RoHS Directive	Pro-active compliance (Product out of EU RoHS legal scope) <a href="#">EU RoHS Declaration</a>
Mercury free	Yes
China RoHS Regulation	<a href="#">China RoHS Declaration</a>
RoHS exemption information	<a href="#">Yes</a>

---

Environmental Disclosure	<a href="#">Product Environmental Profile</a>
Circularity Profile	<a href="#">End Of Life Information</a>
WEEE	The product must be disposed on European Union markets following specific waste collection and never end up in rubbish bins.

---

### Contractual warranty

---

Warranty	18 months
----------	-----------

---

Dimensions

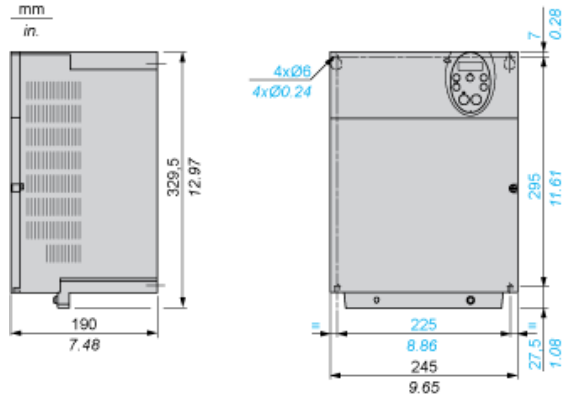
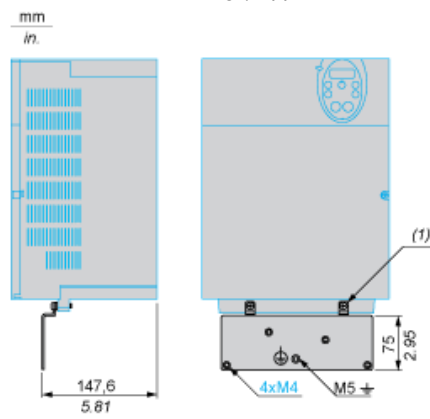

Plate for EMC mounting (supplied with the drive)



(1) 2 x M5 screws

Mounting Recommendations

Clearance

Depending on the conditions in which the drive is to be used, its installation will require certain precautions and the use of appropriate accessories.

Install the unit vertically:

- Do not place it close to heating elements.
- Leave sufficient free space to ensure that the air required for cooling purposes can circulate from bottom to the top of the unit.



Mounting Types

Type A mounting



Type B mounting

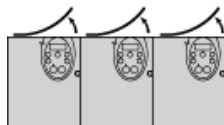

Type C mounting



By removing the protective blanking cover from the top of the drive, the degree of protection for the drive becomes IP21. The protective blanking cover may vary according to the drive model, see opposite.

Specific Recommendations for Mounting in an Enclosure

To help ensure proper air circulation in the drive:

- Fit ventilation grilles.
- Check that there is sufficient ventilation. If there is not, install a forced ventilation unit with a filter. The openings and/or fans must provide a flow rate at least equal to that of the drive fans (refer to the product characteristics).

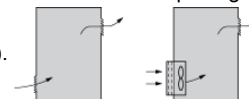

- Use special filters with UL Type 12/IP54 protection.
- Remove the blanking cover from the top of the drive.

### Sealed Metal Enclosure (IP54 Degree of Protection)

The drive must be mounted in a dust and damp proof enclosure in certain environmental conditions, such as dust, corrosive gases, high humidity with risk of condensation and dripping water, splashing liquid, etc. This enables the drive to be used in an enclosure where the maximum internal temperature reaches 50°C.



Recommended Wiring Diagram

3-Phase Power Supply



A1: ATV 212 drive

KM1: Contactor

Q1: Circuit breaker

Q2: GV2 L rated at twice the nominal primary current of T1

Q3: GB2CB05

S1, XB4 B or XB5 A pushbuttons

S2:

T1: 100 VA transformer 220 V secondary

(1) Fault relay contacts for remote signalling of the drive status

(2) Connection of the common for the logic inputs depends on the positioning of the switch (Source, PLC, Sink)

(3) Reference potentiometer SZ1RV1202

NOTE: All terminals are located at the bottom of the drive. Install interference suppressors on all inductive circuits near the drive or connected on the same circuit, such as relays, contactors, solenoid valves, fluorescent lighting, etc.

Switches (Factory Settings)

Voltage/current selection for analog I/O (VIA and VIB)



Voltage/current selection for analog I/O (FM)



Selection of logic type



(1) negative logic

(2) positive logic

Other Possible Wiring Diagrams

## Logic Inputs According to the Position of the Logic Type Switch

“Source” position



“Sink” position



“PLC” position with PLC transistor outputs	
<p>(1) PLC</p>	<p>(1) PLC</p>

2-wire control



- F: Forward
- R: Preset speed
- (2) ATV 212 control terminals

3-wire control

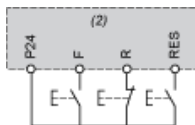

- F: Forward
- R: Stop
- RES: Reverse
- (2) ATV 212 control terminals

PTC probe

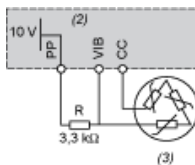

- (2) ATV 212 control terminals
- (3) Motor

## Analog Inputs

Voltage analog inputs

External +10 V	
<p>(2) ATV 212 control terminals (4) Speed reference potentiometer 2.2 to 10 kΩ</p>	<p>(2) ATV 212 control terminals</p>

Analog input configured for current: 0-20 mA, 4-20 mA, X-Y mA



(2) ATV 212 control terminals

(5) Source 0-20 mA, 4-20 mA, X-Y mA

Analog input VIA configured as positive logic input ("Source" position)



(2) ATV 212 control terminals

Analog input VIA configured as negative logic input ("Sink" position)



(2) ATV 212 control terminals

## Derating Curves

The derating curves for the drive nominal current ( $I_n$ ) depend on the temperature, the switching frequency and the mounting type (A, B or C). For intermediate temperatures (45°C for example), interpolate between 2 curves.

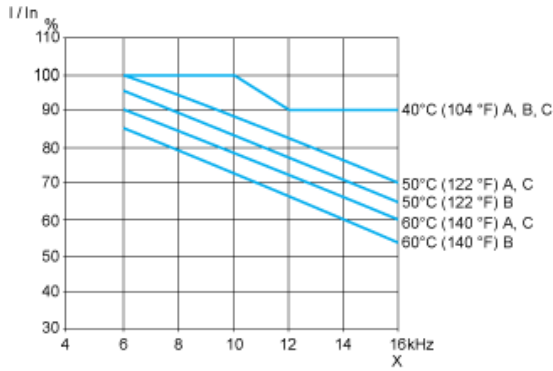

X Switching frequency