

Modicon M251 Logic Controller

Hardware Guide

EIO0000003101.04
11/2022



Legal Information

The Schneider Electric brand and any trademarks of Schneider Electric SE and its subsidiaries referred to in this guide are the property of Schneider Electric SE or its subsidiaries. All other brands may be trademarks of their respective owners.

This guide and its content are protected under applicable copyright laws and furnished for informational use only. No part of this guide may be reproduced or transmitted in any form or by any means (electronic, mechanical, photocopying, recording, or otherwise), for any purpose, without the prior written permission of Schneider Electric.

Schneider Electric does not grant any right or license for commercial use of the guide or its content, except for a non-exclusive and personal license to consult it on an "as is" basis. Schneider Electric products and equipment should be installed, operated, serviced, and maintained only by qualified personnel.

As standards, specifications, and designs change from time to time, information contained in this guide may be subject to change without notice.

To the extent permitted by applicable law, no responsibility or liability is assumed by Schneider Electric and its subsidiaries for any errors or omissions in the informational content of this material or consequences arising out of or resulting from the use of the information contained herein.

As part of a group of responsible, inclusive companies, we are updating our communications that contain non-inclusive terminology. Until we complete this process, however, our content may still contain standardized industry terms that may be deemed inappropriate by our customers.

© 2022 – Schneider Electric. All rights reserved.

Table of Contents

Safety Information	5
Qualification of Personnel	5
Intended Use	6
About the Book	7
Modicon M251 Logic Controller Introduction	13
M251 General Overview	14
M251 Logic Controller Description	14
Maximum Hardware Configuration	16
TM2 Expansion Modules	18
TM3 Expansion Modules	22
TM3 Bus Couplers	31
TM4 Expansion Modules	31
TM5 Fieldbus Interfaces	32
TM5 CANopen Fieldbus Interfaces	32
TM7 CANopen Fieldbus Interfaces	33
Accessories	34
M251 Features	35
Real Time Clock (RTC)	35
Run/Stop	38
SD Card	39
M251 Installation	42
M251 Logic Controller General Rules for Implementing	42
Environmental Characteristics	42
Certifications and Standards	44
M251 Logic Controller Installation	45
Installation and Maintenance Requirements	45
M251 Logic Controller Mounting Positions and Clearances	46
Top Hat Section Rail (DIN rail)	49
Installing and Removing the Controller with Expansions	51
Direct Mounting on a Panel Surface	53
M251 Electrical Requirements	54
Wiring Best Practices	54
DC Power Supply Characteristics and Wiring	56
Grounding the M251 System	59
Modicon M251 Logic Controller	61
TM251MESC	62
TM251MESC Presentation	62
TM251MESE	65
TM251MESE Presentation	65
Modicon M251 Logic Controller Communication	68
Integrated Communication Ports	69
CANopen Port	69
Ethernet Port	72
TM251MESE Specific Considerations	73
USB Mini-B Programming Port	75
Serial Line	76
Connecting the M251 Logic Controller to a PC	79
Connecting the Controller to a PC	79

Glossary	83
Index	87

Safety Information

Important Information

Read these instructions carefully, and look at the equipment to become familiar with the device before trying to install, operate, service, or maintain it. The following special messages may appear throughout this documentation or on the equipment to warn of potential hazards or to call attention to information that clarifies or simplifies a procedure.



The addition of this symbol to a “Danger” or “Warning” safety label indicates that an electrical hazard exists which will result in personal injury if the instructions are not followed.



This is the safety alert symbol. It is used to alert you to potential personal injury hazards. Obey all safety messages that follow this symbol to avoid possible injury or death.

⚠ DANGER
DANGER indicates a hazardous situation which, if not avoided, will result in death or serious injury.

⚠ WARNING
WARNING indicates a hazardous situation which, if not avoided, could result in death or serious injury.

⚠ CAUTION
CAUTION indicates a hazardous situation which, if not avoided, could result in minor or moderate injury.

NOTICE
NOTICE is used to address practices not related to physical injury.

Please Note

Electrical equipment should be installed, operated, serviced, and maintained only by qualified personnel. No responsibility is assumed by Schneider Electric for any consequences arising out of the use of this material.

A qualified person is one who has skills and knowledge related to the construction and operation of electrical equipment and its installation, and has received safety training to recognize and avoid the hazards involved.

Qualification of Personnel

Only appropriately trained persons who are familiar with and understand the contents of this manual and all other pertinent product documentation are authorized to work on and with this product.

The qualified person must be able to detect possible hazards that may arise from parameterization, modifying parameter values and generally from mechanical, electrical, or electronic equipment. The qualified person must be familiar with the standards, provisions, and regulations for the prevention of industrial accidents, which they must observe when designing and implementing the system.

Intended Use

The products described or affected by this document, together with software, accessories, and options, are programmable logic controllers (referred to herein as “logic controllers”), intended for industrial use according to the instructions, directions, examples, and safety information contained in the present document and other supporting documentation.

The product may only be used in compliance with all applicable safety regulations and directives, the specified requirements, and the technical data.

Prior to using the product, you must perform a risk assessment in view of the planned application. Based on the results, the appropriate safety-related measures must be implemented.

Since the product is used as a component in an overall machine or process, you must ensure the safety of persons by means of the design of this overall system.

Operate the product only with the specified cables and accessories. Use only genuine accessories and spare parts.

Any use other than the use explicitly permitted is prohibited and can result in unanticipated hazards.

About the Book

Document Scope

Use this document to:

- Install and operate your M251 Logic Controller.
- Connect the M251 Logic Controller to a programming device equipped with EcoStruxure Machine Expert software.
- Interface the M251 Logic Controller with I/O expansion modules, HMI and other devices.
- Familiarize yourself with the M251 Logic Controller features.

NOTE: Read and understand this document and all related documents before installing, operating, or maintaining your controller.

Validity Note

This document has been updated for the release of EcoStruxure™ Machine Expert V2.1.

For product compliance and environmental information (RoHS, REACH, PEP, EOL, etc.), go to www.se.com/ww/en/work/support/green-premium/.

The technical characteristics of the devices described in this manual also appear online (<https://www.se.com/>).

The characteristics that are described in the present document should be the same as those characteristics that appear online. In line with our policy of constant improvement, we may revise content over time to improve clarity and accuracy. If you see a difference between the document and online information, use the online information as your reference.

Related Documents

Title of Documentation	Reference Number
Modicon M251 Logic Controller - Programming Guide	EIO0000003089 (ENG)
	EIO0000003090 (FRE)
	EIO0000003091 (GER)
	EIO0000003092 (SPA)
	EIO0000003093 (ITA)
	EIO0000003094 (CHS)
EcoStruxure Machine Expert Industrial Ethernet User Guide	EIO0000003053 (ENG)
	EIO0000003054 (FRE)
	EIO0000003055 (GER)
	EIO0000003056 (SPA)
	EIO0000003057 (ITA)
	EIO0000003058 (CHS)

Title of Documentation	Reference Number
Modicon TM3 Digital I/O Modules - Hardware Guide	EIO0000003125 (ENG) EIO0000003126 (FRE) EIO0000003127 (GER) EIO0000003128 (SPA) EIO0000003129 (ITA) EIO0000003130 (CHS) EIO0000003425 (TUR) EIO0000003424 (POR)
Modicon TM3 Expert I/O Modules - Hardware Guide	EIO0000003137 (ENG) EIO0000003138 (FRE) EIO0000003139 (GER) EIO0000003140 (SPA) EIO0000003141 (ITA) EIO0000003142 (CHS) EIO0000003429 (TUR) EIO0000003428 (POR)
Modicon TM3 Safety Modules - Hardware Guide	EIO0000003353 (ENG) EIO0000003354 (FRE) EIO0000003355 (GER) EIO0000003356 (SPA) EIO0000003357 (ITA) EIO0000003358 (CHS) EIO0000003359 (POR) EIO0000003360 (TUR)
Modicon TM3 Transmitter and Receiver Modules - Hardware Guide	EIO0000003143 (ENG) EIO0000003144 (FRE) EIO0000003145 (GER) EIO0000003146 (SPA) EIO0000003147 (ITA) EIO0000003148 (CHS) EIO0000003431 (TUR) EIO0000003430 (POR)
Modicon TM3 Bus Coupler - Hardware Guide	EIO0000003635 (ENG) EIO0000003636 (FRE) EIO0000003637 (GER) EIO0000003638 (SPA) EIO0000003639 (ITA) EIO0000003640 (CHS) EIO0000003641 (POR) EIO0000003642 (TUR)

Title of Documentation	Reference Number
Modicon TM4 Expansion Modules - Hardware Guide	EIO0000003155 (ENG)
	EIO0000003156 (FRE)
	EIO0000003157 (GER)
	EIO0000003158 (SPA)
	EIO0000003159 (ITA)
	EIO0000003160 (CHS)
Modicon TM5 Fieldbus Interface - Hardware Guide	EIO0000003715 (ENG)
	EIO0000003716 (FRE)
	EIO0000003717 (GER)
	EIO0000003718 (SPA)
	EIO0000003719 (ITA)
	EIO0000003720 (CHS)
M251 Logic Controller - Instruction Sheet	HRB59604

You can download these technical publications and other technical information from our website at www.se.com/ww/en/download/ .

Product Related Information

 **DANGER**

HAZARD OF ELECTRIC SHOCK, EXPLOSION OR ARC FLASH

- Disconnect all power from all equipment including connected devices prior to removing any covers or doors, or installing or removing any accessories, hardware, cables, or wires except under the specific conditions specified in the appropriate hardware guide for this equipment.
- Always use a properly rated voltage sensing device to confirm the power is off where and when indicated.
- Replace and secure all covers, accessories, hardware, cables, and wires and confirm that a proper ground connection exists before applying power to the unit.
- Use only the specified voltage when operating this equipment and any associated products.

Failure to follow these instructions will result in death or serious injury.

 **DANGER**

POTENTIAL FOR EXPLOSION

- Only use this equipment in non-hazardous locations, or in locations that comply with Class I, Division 2, Groups A, B, C and D.
- Do not substitute components which would impair compliance to Class I, Division 2.
- Do not connect or disconnect equipment unless power has been removed or the location is known to be non-hazardous.
- Do not use the USB port(s), if so equipped, unless the location is known to be non-hazardous.

Failure to follow these instructions will result in death or serious injury.

⚠ WARNING**LOSS OF CONTROL**

- The designer of any control scheme must consider the potential failure modes of control paths and, for certain critical control functions, provide a means to achieve a safe state during and after a path failure. Examples of critical control functions are emergency stop and overtravel stop, power outage and restart.
- Separate or redundant control paths must be provided for critical control functions.
- System control paths may include communication links. Consideration must be given to the implications of unanticipated transmission delays or failures of the link.
- Observe all accident prevention regulations and local safety guidelines.¹
- Each implementation of this equipment must be individually and thoroughly tested for proper operation before being placed into service.

Failure to follow these instructions can result in death, serious injury, or equipment damage.

¹ For additional information, refer to NEMA ICS 1.1 (latest edition), "Safety Guidelines for the Application, Installation, and Maintenance of Solid State Control" and to NEMA ICS 7.1 (latest edition), "Safety Standards for Construction and Guide for Selection, Installation and Operation of Adjustable-Speed Drive Systems" or their equivalent governing your particular location.

⚠ WARNING**UNINTENDED EQUIPMENT OPERATION**

- Only use software approved by Schneider Electric for use with this equipment.
- Update your application program every time you change the physical hardware configuration.

Failure to follow these instructions can result in death, serious injury, or equipment damage.

Terminology Derived from Standards

The technical terms, terminology, symbols and the corresponding descriptions in this manual, or that appear in or on the products themselves, are generally derived from the terms or definitions of international standards.

In the area of functional safety systems, drives and general automation, this may include, but is not limited to, terms such as *safety*, *safety function*, *safe state*, *fault*, *fault reset*, *malfunction*, *failure*, *error*, *error message*, *dangerous*, etc.

Among others, these standards include:

Standard	Description
IEC 61131-2:2007	Programmable controllers, part 2: Equipment requirements and tests.
ISO 13849-1:2015	Safety of machinery: Safety related parts of control systems. General principles for design.
EN 61496-1:2013	Safety of machinery: Electro-sensitive protective equipment. Part 1: General requirements and tests.
ISO 12100:2010	Safety of machinery - General principles for design - Risk assessment and risk reduction
EN 60204-1:2006	Safety of machinery - Electrical equipment of machines - Part 1: General requirements
ISO 14119:2013	Safety of machinery - Interlocking devices associated with guards - Principles for design and selection
ISO 13850:2015	Safety of machinery - Emergency stop - Principles for design
IEC 62061:2015	Safety of machinery - Functional safety of safety-related electrical, electronic, and electronic programmable control systems
IEC 61508-1:2010	Functional safety of electrical/electronic/programmable electronic safety-related systems: General requirements.
IEC 61508-2:2010	Functional safety of electrical/electronic/programmable electronic safety-related systems: Requirements for electrical/electronic/programmable electronic safety-related systems.
IEC 61508-3:2010	Functional safety of electrical/electronic/programmable electronic safety-related systems: Software requirements.
IEC 61784-3:2016	Industrial communication networks - Profiles - Part 3: Functional safety fieldbuses - General rules and profile definitions.
2006/42/EC	Machinery Directive
2014/30/EU	Electromagnetic Compatibility Directive
2014/35/EU	Low Voltage Directive

In addition, terms used in the present document may tangentially be used as they are derived from other standards such as:

Standard	Description
IEC 60034 series	Rotating electrical machines
IEC 61800 series	Adjustable speed electrical power drive systems
IEC 61158 series	Digital data communications for measurement and control – Fieldbus for use in industrial control systems

Finally, the term *zone of operation* may be used in conjunction with the description of specific hazards, and is defined as it is for a *hazard zone* or *danger zone* in the *Machinery Directive (2006/42/EC)* and *ISO 12100:2010*.

NOTE: The aforementioned standards may or may not apply to the specific products cited in the present documentation. For more information concerning the individual standards applicable to the products described herein, see the characteristics tables for those product references.

Modicon M251 Logic Controller Introduction

What's in This Part

M251 General Overview	14
M251 Features.....	35
M251 Installation	42

M251 General Overview

What's in This Chapter

M251 Logic Controller Description	14
Maximum Hardware Configuration.....	16
TM2 Expansion Modules.....	18
TM3 Expansion Modules.....	22
TM3 Bus Couplers.....	31
TM4 Expansion Modules.....	31
TM5 Fieldbus Interfaces	32
TM5 CANopen Fieldbus Interfaces	32
TM7 CANopen Fieldbus Interfaces	33
Accessories	34

Overview

This chapter provides general information about the M251 Logic Controller system architecture and its components.

M251 Logic Controller Description

Overview

The M251 Logic Controller has various powerful features and can service a wide range of applications.

Software configuration, programming, and commissioning are achieved with the EcoStruxure Machine Expert software described in the EcoStruxure Machine Expert Programming Guide (see EcoStruxure Machine Expert, Programming Guide) and in the M251 Logic Controller Programming Guide.

Programming Languages

The M251 Logic Controller is configured and programmed with the EcoStruxure Machine Expert software, which supports the following IEC 61131-3 programming languages:

- IL: Instruction list
- ST: Structured text
- FBD: Function block diagram
- SFC: Sequential function chart
- LD: Ladder diagram

EcoStruxure Machine Expert software can also be used to program this controller using CFC (continuous function chart) language.

Power Supply

The power supply of the M251 Logic Controller is 24 Vdc, page 56.

Real Time Clock

The M251 Logic Controller includes a Real Time Clock (RTC) system, page 35.

Run/Stop

The M251 Logic Controller can be operated externally by the following:

- A hardware Run/Stop switch, page 38
- An EcoStruxure Machine Expert software command
- The system variable PLC_W in a Relocation Table
- The Web server

Memory

This table describes the different types of memory:

Memory Type	Size	Used to
RAM	64 Mbytes, of which 8 Mbytes available for the application	Execute the application.
Flash	128 Mbytes	Save the program and data in case of a power interruption.

Removable Storage

M251 Logic Controllers include an embedded SD card slot, page 39.

The main uses of the SD card are:

- Initializing the controller with a new application
- Updating the controller firmware
- Applying post configuration files to the controller
- Applying recipes
- Receiving data logging files

Embedded Communication Features

The M251 Logic Controller native communication ports include (depending on the controller reference):

- CANopen Master, page 69
- Ethernet, page 72
- USB Mini-B, page 75
- Serial Line, page 76

Expansion Module and Bus Coupler Compatibility

Refer to the compatibility tables in the EcoStruxure Machine Expert - Compatibility and Migration User Guide.

M251 Logic Controllers

Reference	Digital Inputs	Digital Outputs	Communication Ports
TM251MESC, page 62	0	0	1 serial line port 1 USB mini-B programming port 1 dual port Ethernet switch 1 CANopen port
TM251MESE, page 65	0	0	1 serial line port 1 USB mini-B programming port 1 dual port Ethernet switch 1 Ethernet port for fieldbus

Maximum Hardware Configuration

Introduction

The M251 Logic Controller is a control system that offers a scalable solution with optimized configurations and an expandable architecture.

Local and Remote Configuration Principle

The following figure defines the local and remote configurations:

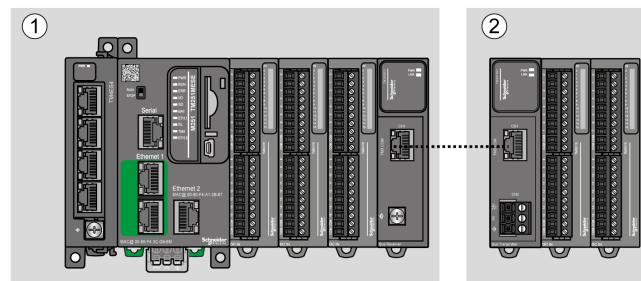

(1) Local configuration

(2) Remote configuration

M251 Logic Controller Local Configuration Architecture

Optimized local configuration and flexibility are provided by the association of:

- M251 Logic Controller
- TM4 expansion modules
- TM3 expansion modules
- TM2 expansion modules

Application requirements determine the architecture of your M251 Logic Controller configuration.

The following figure represents the components of a local configuration:

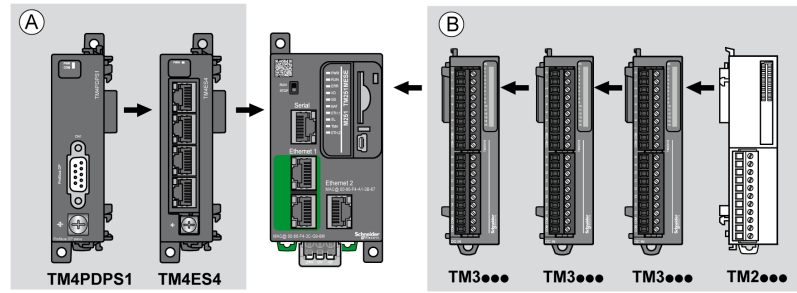

(A) Expansion modules (3 maximum)

(B) Expansion modules (7 maximum)

NOTE: It is prohibited to mount a TM2 module before any TM3 module as indicated in the following figure:

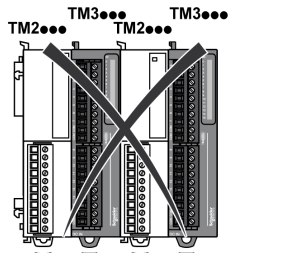

M251 Logic Controller Remote Configuration Architecture

Optimized remote configuration and flexibility are provided by the association of:

- M251 Logic Controller
- TM4 expansion modules
- TM3 expansion modules
- TM3 transmitter and receiver modules

Application requirements determine the architecture of your M251 Logic Controller configuration.

NOTE: You cannot use TM2 modules in configurations that include the TM3 transmitter and receiver modules.

The following figure represents the components of a remote configuration:

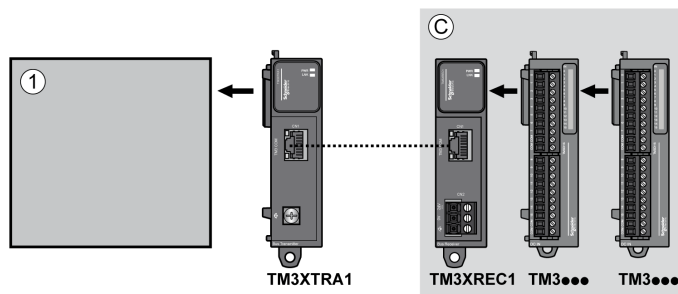

(1) Logic controller and modules

(C) TM3 expansion modules (7 maximum)

Maximum Number of Modules

The following table shows the maximum configuration supported:

References	Maximum	Type of Configuration
TM251****	7 TM3 / TM2 expansion modules	Local
TM251****	3 TM4 expansion modules	Local
TM3XREC1	7 TM3 expansion modules	Remote
<p>NOTE: TM3 transmitter and receiver modules are not included in a count of the maximum number of expansion modules.</p>		

NOTE: The configuration with its TM4, TM3, and TM2 expansion modules is validated by EcoStruxure Machine Expert software in the **Configuration** window.

NOTE: In some environments, the maximum configuration populated by high consumption modules, coupled with the maximum distance allowable between the TM3 transmitter and receiver modules, may present bus communication issues although the EcoStruxure Machine Expert software allows for the configuration. In such a case you will need to analyze the power consumption of the modules chosen for your configuration, as well as the minimum cable distance required by your application, and possibly seek to optimize your choices.

TM2 Expansion Modules

Overview

You can expand the number of I/Os of your M251 Logic Controller by adding TM2 I/O expansion modules.

The following types of electronic modules are supported:

- TM2 digital I/O expansion modules
- TM2 analog I/O expansion modules

For more information, refer to the following documents:

- TM2 Digital I/O Expansion Modules Hardware Guide
- TM2 Analog I/O Expansion Modules Hardware Guide

NOTE: TM2 modules can only be used in the local configuration, and only if there is no TM3 transmitter and receiver modules present in the configuration.

NOTE: It is prohibited to mount a TM2 module before any TM3 module. The TM2 modules must be mounted and configured at the end of the local configuration.

TM2 Digital Input Expansion Modules

The following table shows the compatible TM2 digital input expansion modules with the corresponding channel type, nominal voltage/current, and terminal type:

Reference	Channels	Channel Type	Voltage Current	Terminal Type
TM2DAI8DT	8	Regular inputs	120 Vac 7.5 mA	Removable screw terminal block
TM2DDI8DT	8	Regular inputs	24 Vdc 7 mA	Removable screw terminal block
TM2DDI16DT	16	Regular inputs	24 Vdc 7 mA	Removable screw terminal block
TM2DDI16DK	16	Regular inputs	24 Vdc 5 mA	HE10 (MIL 20) connector
TM2DDI32DK	32	Regular inputs	24 Vdc 5 mA	HE10 (MIL 20) connector

TM2 Digital Output Expansion Modules

The following table shows the compatible TM2 digital output expansion modules with the corresponding channel type, nominal voltage/current, and terminal type:

Reference	Channels	Channel type	Voltage Current	Terminal type
TM2DRA8RT	8	Relay outputs	30 Vdc / 240 Vac 2 A max	Removable screw terminal block
TM2DRA16RT	16	Relay outputs	30 Vdc / 240 Vac 2 A max	Removable screw terminal block
TM2DDO8UT	8	Regular transistor outputs (sink)	24 Vdc 0.3 A max per output	Removable screw terminal block
TM2DDO8TT	8	Regular transistor outputs (source)	24 Vdc 0.5 A max per output	Removable screw terminal block
TM2DDO16UK	16	Regular transistor outputs (sink)	24 Vdc 0.1 A max per output	HE10 (MIL 20) connector
TM2DDO16TK	16	Regular transistor outputs (source)	24 Vdc 0.4 A max per output	HE10 (MIL 20) connector
TM2DDO32UK	32	Regular transistor outputs (sink)	24 Vdc 0.1 A max per output	HE10 (MIL 20) connector
TM2DDO32TK	32	Regular transistor outputs (source)	24 Vdc 0.4 A max per output	HE10 (MIL 20) connector

TM2 Digital Mixed Input/Output Expansion Modules

The following table shows the compatible TM2 digital mixed I/O expansion modules with the corresponding channel type, nominal voltage/current, and terminal type:

Reference	Channels	Channel type	Voltage Current	Terminal type
TM2DMM8DRT	4	Regular inputs	24 Vdc 7 mA	Removable screw terminal block
	4	Relay outputs	24 Vdc / 240 Vac 7 A maximum per common line / 2 A maximum per output	
TM2DMM24DRF	16	Regular inputs	24 Vdc 7 mA	Non-removable spring terminal block
	8	Relay outputs	24 Vdc / 240 Vac 7 A maximum per common line / 2 A maximum per output	

TM2 Analog Input Expansion Modules

The following table shows the compatible TM2 analog input expansion modules with the corresponding channel type, nominal voltage/current, and terminal type:

Reference	Channels	Channel type	Voltage Current	Terminal Type
TM2AMI2HT	2	High-level inputs	0...10 Vdc 4...20 mA	Removable screw terminal block
TM2AMI2LT	2	Low-level inputs	Thermocouple type J, K, T	Removable screw terminal block
TM2AMI4LT	4	Analog inputs	0...10 Vdc 0...20 mA PT100/1000 Ni100/1000	Removable screw terminal block
TM2AMI8HT	8	Analog inputs	0...10 Vdc 0...20 mA	Removable screw terminal block
TM2ARI8HT	8	Analog inputs	NTC / PTC	Removable screw terminal block
TM2ARI8LRJ	8	Analog inputs	PT100/1000	RJ11 connector
TM2ARI8LT	8	Analog inputs	PT100/1000	Removable screw terminal block

TM2 Analog Output Expansion Modules

The following table shows the compatible TM2 analog output expansion modules with the corresponding channel type, nominal voltage/current, and terminal type:

Reference	Channels	Channel type	Voltage Current	Terminal Type
TM2AMO1HT	1	Analog outputs	0...10 Vdc 4...20 mA	Removable screw terminal block
TM2AVO2HT	2	Analog outputs	+/- 10 Vdc	Removable screw terminal block

TM2 Analog Mixed Input/Output Expansion Modules

The following table shows the compatible TM2 analog mixed I/O expansion modules with the corresponding channel type, nominal voltage/current, and terminal type:

Reference	Channels	Channel type	Voltage Current	Terminal Type
TM2AMM3HT	2	Analog inputs	0...10 Vdc 4...20 mA	Removable screw terminal block
	1	Analog outputs	0...10 Vdc 4...20 mA	
TM2AMM6HT	4	Analog inputs	0...10 Vdc 4...20 mA	Removable screw terminal block
	2	Analog outputs	0...10 Vdc 4...20 mA	
TM2ALM3LT	2	Low-level inputs	Thermocouple type J, K, T PT100	Removable screw terminal block
	1	Analog outputs	0...10 Vdc 4...20 mA	

TM3 Expansion Modules

Introduction

The range of TM3 expansion modules includes:

- Digital modules, classified as follows:
 - Input modules, page 22
 - Output modules, page 23
 - Mixed input/output modules, page 25
- Analog modules, classified as follows:
 - Input modules, page 26
 - Output modules, page 27
 - Mixed input/output modules, page 28
- Expert modules, page 29
- Safety modules, page 30
- Transmitter and Receiver modules, page 31

For more information, refer to the following documents in Related Documents, page 7:

- TM3 Digital I/O Modules Hardware Guide
- TM3 Analog I/O Modules Hardware Guide
- TM3 Expert I/O Modules Hardware Guide
- TM3 Safety Modules Hardware Guide
- TM3 Transmitter and Receiver Modules Hardware Guide

TM3 Digital Input Modules

The following table shows the TM3 digital input expansion modules, with corresponding channel type, nominal voltage/current, and terminal type:

Reference	Channels	Channel Type	Voltage Current	Terminal Type / Pitch
TM3DI8A	8	Regular inputs	120 Vac 7.5 mA	Removable screw terminal block / 5.08 mm
TM3DI8	8	Regular inputs	24 Vdc 7 mA	Removable screw terminal block / 5.08 mm
TM3DI8G	8	Regular inputs	24 Vdc 7 mA	Removable spring terminal block / 5.08 mm
TM3DI16	16	Regular inputs	24 Vdc 7 mA	Removable screw terminal blocks / 3.81 mm
TM3DI16G	16	Regular inputs	24 Vdc 7 mA	Removable spring terminal blocks / 3.81 mm
TM3DI16K	16	Regular inputs	24 Vdc 5 mA	HE10 (MIL 20) connector
TM3DI32K	32	Regular inputs	24 Vdc 5 mA	HE10 (MIL 20) connector

TM3 Digital Output Modules

The following table shows the TM3 digital output expansion modules, with corresponding channel type, nominal voltage/current, and terminal type:

Reference	Channels	Channel Type	Voltage Current	Terminal Type / Pitch
TM3DQ8R	8	Relay outputs	24 Vdc / 240 Vac 7 A maximum per common line / 2 A maximum per output	Removable screw terminal block / 5.08 mm
TM3DQ8RG	8	Relay outputs	24 Vdc / 240 Vac 7 A maximum per common line / 2 A maximum per output	Removable spring terminal block / 5.08 mm
TM3DQ8T	8	Regular transistor outputs (source)	24 Vdc 4 A maximum per common line/0.5 A maximum per output	Removable screw terminal block / 5.08 mm
TM3DQ8TG	8	Regular transistor outputs (source)	24 Vdc 4 A maximum per common line/0.5 A maximum per output	Removable spring terminal block / 5.08 mm
TM3DQ8U	8	Regular transistor outputs (sink)	24 Vdc 4 A maximum per common line/0.5 A maximum per output	Removable screw terminal block / 5.08 mm
TM3DQ8UG	8	Regular transistor outputs (sink)	24 Vdc 4 A maximum per common line/0.5 A maximum per output	Removable spring terminal block / 5.08 mm
TM3DQ16R	16	Relay outputs	24 Vdc / 240 Vac 8 A maximum per common line / 2 A maximum per output	Removable screw terminal blocks / 3.81 mm
TM3DQ16RG	16	Relay outputs	24 Vdc / 240 Vac 8 A maximum per common line / 2 A maximum per output	Removable spring terminal blocks / 3.81 mm
TM3DQ16T	16	Regular transistor outputs (source)	24 Vdc 8 A maximum per common line / 0.5 A maximum per output	Removable screw terminal blocks / 3.81 mm
TM3DQ16TG	16	Regular transistor outputs (source)	24 Vdc 8 A maximum per common line / 0.5 A maximum per output	Removable spring terminal blocks / 3.81 mm
TM3DQ16U	16	Regular transistor outputs (sink)	24 Vdc 8 A maximum per common line / 0.5 A maximum per output	Removable screw terminal blocks / 3.81 mm
TM3DQ16UG	16	Regular transistor outputs (sink)	24 Vdc 8 A maximum per common line / 0.5 A maximum per output	Removable spring terminal blocks / 3.81 mm

Reference	Channels	Channel Type	Voltage Current	Terminal Type / Pitch
TM3DQ16TK	16	Regular transistor outputs (source)	24 Vdc 2 A maximum per common line / 0.1 A maximum per output	HE10 (MIL 20) connector
TM3DQ16UK	16	Regular transistor outputs (sink)	24 Vdc 2 A maximum per common line / 0.1 A maximum per output	HE10 (MIL 20) connector
TM3DQ32TK	32	Regular transistor outputs (source)	24 Vdc 2 A maximum per common line / 0.1 A maximum per output	HE10 (MIL 20) connectors
TM3DQ32UK	32	Regular transistor outputs (sink)	24 Vdc 2 A maximum per common line / 0.1 A maximum per output	HE10 (MIL 20) connectors

TM3 Digital Mixed Input/Output Modules

This following table shows the TM3 mixed I/O modules, with corresponding channel type, nominal voltage/current, and terminal type:

Reference	Channels	Channel Type	Voltage Current	Terminal Type / Pitch
TM3DM8R	4	Regular inputs	24 Vdc 7 mA	Removable screw terminal block / 5.08 mm
	4	Relay outputs	24 Vdc / 240 Vac 7 A maximum per common line / 2 A maximum per output	
TM3DM8RG	4	Regular inputs	24 Vdc 7 mA	Removable spring terminal block / 5.08 mm
	4	Relay outputs	24 Vdc / 240 Vac 7 A maximum per common line / 2 A maximum per output	
TM3DM16R ⁽¹⁾	8	Regular inputs	24 Vdc 5 mA	Removable screw terminal block / 3.81 mm
	8	Relay outputs	24 Vdc / 240 Vac 4 A maximum per common line / 2 A maximum per output	
TM3DM24R	16	Regular inputs	24 Vdc 7 mA	Removable screw terminal block / 3.81 mm
	8	Relay outputs	24 Vdc / 240 Vac 7 A maximum per common line / 2 A maximum per output	
TM3DM24RG	16	Regular inputs	24 Vdc 7 mA	Removable spring terminal block / 3.81 mm
	8	Relay outputs	24 Vdc / 240 Vac 7 A maximum per common line / 2 A maximum per output	
TM3DM32R ⁽¹⁾	16	Regular inputs	24 Vdc 5 mA	Removable screw terminal block / 3.81 mm
	16	Relay outputs	24 Vdc / 240 Vac 4 A maximum per common line / 2 A maximum per output	

(1) This expansion module is available only in selected countries.

TM3 Analog Input Modules

The following table shows the TM3 analog input expansion modules, with corresponding resolution, channel type, nominal voltage/current, and terminal type:

Reference	Resolution	Channels	Channel Type	Mode	Terminal Type / Pitch
TM3AI2H	16 bit, or 15 bit + sign	2	inputs	0...10 Vdc -10...+10 Vdc 0...20 mA 4...20 mA	Removable screw terminal block / 5.08 mm
TM3AI2HG	16 bit, or 15 bit + sign	2	inputs	0...10 Vdc -10...+10 Vdc 0...20 mA 4...20 mA	Removable spring terminal block / 5.08 mm
TM3AI4	12 bit, or 11 bit + sign	4	inputs	0...10 Vdc -10...+10 Vdc 0...20 mA 4...20 mA	Removable screw terminal block / 3.81 mm
TM3AI4G	12 bit, or 11 bit + sign	4	inputs	0...10 Vdc -10...+10 Vdc 0...20 mA 4...20 mA	Removable spring terminal blocks / 3.81 mm
TM3AI8	12 bit, or 11 bit + sign	8	inputs	0...10 Vdc -10...+10 Vdc 0...20 mA 4...20 mA 0...20 mA extended 4...20 mA extended	Removable screw terminal block / 3.81 mm
TM3AI8G	12 bit, or 11 bit + sign	8	inputs	0...10 Vdc -10...+10 Vdc 0...20 mA 4...20 mA 0...20 mA extended 4...20 mA extended	Removable spring terminal blocks / 3.81 mm
TM3TI4	16 bit, or 15 bit + sign	4	inputs	0...10 Vdc -10...+10 Vdc 0...20 mA 4...20 mA Thermocouple PT100/1000 NI100/1000	Removable screw terminal block / 3.81 mm

Reference	Resolution	Channels	Channel Type	Mode	Terminal Type / Pitch
TM3TI4G	16 bit, or 15 bit + sign	4	inputs	0...10 Vdc -10...+10 Vdc 0...20 mA 4...20 mA Thermocouple PT100/1000 NI100/1000	Removable spring terminal blocks / 3.81 mm
TM3TI4D	16 bit, or 15 bit + sign	4	inputs	Thermocouple	Removable screw terminal block / 3.81 mm
TM3TI4DG	16 bit, or 15 bit + sign	4	inputs	Thermocouple	Removable spring terminal blocks / 3.81 mm
TM3TI8T	16 bit, or 15 bit + sign	8	inputs	Thermocouple NTC/PTC Ohmmeter	Removable screw terminal block / 3.81 mm
TM3TI8TG	16 bit, or 15 bit + sign	8	inputs	Thermocouple NTC/PTC Ohmmeter	Removable spring terminal blocks / 3.81 mm

TM3 Analog Output Modules

The following table shows the TM3 analog output modules, with corresponding resolution, channel type, nominal voltage/current, and terminal type:

Reference	Resolution	Channels	Channel Type	Mode	Terminal Type / Pitch
TM3AQ2	12 bit, or 11 bit + sign	2	outputs	0...10 Vdc -10...+10 Vdc 0...20 mA 4...20 mA	Removable screw terminal block / 5.08 mm
TM3AQ2G	12 bit, or 11 bit + sign	2	outputs	0...10 Vdc -10...+10 Vdc 0...20 mA 4...20 mA	Removable spring terminal block / 5.08 mm
TM3AQ4	12 bit, or 11 bit + sign	4	outputs	0...10 Vdc -10...+10 Vdc 0...20 mA 4...20 mA	Removable screw terminal block / 5.08 mm
TM3AQ4G	12 bit, or 11 bit + sign	4	outputs	0...10 Vdc -10...+10 Vdc 0...20 mA 4...20 mA	Removable spring terminal block / 5.08 mm

TM3 Analog Mixed Input/Output Modules

This following table shows the TM3 analog mixed I/O modules, with corresponding resolution, channel type, nominal voltage/current, and terminal type:

Reference	Resolution	Channels	Channel Type	Mode	Terminal Type / Pitch
TM3AM6	12 bit, or 11 bit + sign	4	inputs	0...10 Vdc	Removable screw terminal block / 3.81 mm
		2	outputs	-10...+10 Vdc 0...20 mA 4...20 mA	
TM3AM6G	12 bit, or 11 bit + sign	4	inputs	0...10 Vdc	Removable spring terminal block / 3.81 mm
		2	outputs	-10...+10 Vdc 0...20 mA 4...20 mA	
TM3TM3	16 bit, or 15 bit + sign	2	inputs	0...10 Vdc -10...+10 Vdc 0...20 mA 4...20 mA Thermocouple PT100/1000 NI100/1000	Removable screw terminal block / 5.08 mm
	12 bit, or 11 bit + sign	1	outputs	0...10 Vdc -10...+10 Vdc 0...20 mA 4...20 mA	
TM3TM3G	16 bit, or 15 bit + sign	2	inputs	0...10 Vdc -10...+10 Vdc 0...20 mA 4...20 mA Thermocouple PT100/1000 NI100/1000	Removable spring terminal block / 5.08 mm
	12 bit, or 11 bit + sign	1	outputs	0...10 Vdc -10...+10 Vdc 0...20 mA 4...20 mA	

TM3 Expert Modules

The following table shows the TM3 expert expansion modules, with corresponding terminal types:

Reference	Description	Terminal Type / Pitch
TM3XTYS4	TeSys module	4 front connectors RJ-45 1 removable power supply connector / 5.08 mm
TM3XHSC202	High Speed Counting (HSC) module	Removable screw terminal blocks / 3.81 mm
TM3XHSC202G	High Speed Counting (HSC) module	Removable spring terminal blocks / 3.81 mm

TM3 Safety Modules

This table contains the TM3 safety modules, with the corresponding channel type, nominal voltage/current, and terminal type:

Reference	Function Category	Channels	Channel type	Voltage Current	Terminal type
TM3SAC5R	1 function, up to category 3	1 or 2 ⁽¹⁾	Safety input	24 Vdc	3.81 mm (0.15 in.) and 5.08 mm (0.20 in.), removable screw terminal block
		Start ⁽²⁾	Input	100 mA maximum	
		3 in parallel	Relay outputs Normally open	24 Vdc / 230 Vac 6 A maximum per output	
TM3SAC5RG	1 function, up to category 3	1 or 2 ⁽¹⁾	Safety input	24 Vdc	3.81 mm (0.15 in.) and 5.08 mm (0.20 in.), removable spring terminal block
		Start ⁽²⁾	Input	100 mA maximum	
		3 in parallel	Relay outputs Normally open	24 Vdc / 230 Vac 6 A maximum per output	
TM3SAF5R	1 function, up to category 4	2 ⁽¹⁾	Safety inputs	24 Vdc	3.81 mm (0.15 in.) and 5.08 mm (0.20 in.), removable screw terminal block
		Start	Input	100 mA maximum	
		3 in parallel	Relay outputs Normally open	24 Vdc / 230 Vac 6 A maximum per output	
TM3SAF5RG	1 function, up to category 4	2 ⁽¹⁾	Safety inputs	24 Vdc	3.81 mm (0.15 in.) and 5.08 mm (0.20 in.), removable spring terminal block
		Start	Input	100 mA maximum	
		3 in parallel	Relay outputs Normally open	24 Vdc / 230 Vac 6 A maximum per output	
TM3SAFL5R	2 functions, up to category 3	2 ⁽¹⁾	Safety inputs	24 Vdc	3.81 mm (0.15 in.) and 5.08 mm (0.20 in.), removable screw terminal block
		Start	Input	100 mA maximum	
		3 in parallel	Relay outputs Normally open	24 Vdc / 230 Vac 6 A maximum per output	
TM3SAFL5RG	2 functions, up to category 3	2 ⁽¹⁾	Safety inputs	24 Vdc	3.81 mm (0.15 in.) and 5.08 mm (0.20 in.), removable spring terminal block
		Start	Input	100 mA maximum	
		3 in parallel	Relay outputs Normally open	24 Vdc / 230 Vac 6 A maximum per output	
TM3SAK6R	3 functions, up to category 4	1 or 2 ⁽¹⁾	Safety inputs	24 Vdc	3.81 mm (0.15 in.) and 5.08 mm (0.20 in.), removable screw terminal block
		Start	Input	100 mA maximum	
		3 in parallel	Relay outputs Normally open	24 Vdc / 230 Vac 6 A maximum per output	
TM3SAK6RG	3 functions, up to category 4	1 or 2 ⁽¹⁾	Safety inputs	24 Vdc	3.81 mm (0.15 in.) and 5.08 mm (0.20 in.), removable spring terminal block
		Start	Input	100 mA maximum	
		3 in parallel	Relay outputs Normally open	24 Vdc / 230 Vac 6 A maximum per output	
⁽¹⁾ Depending on external wiring ⁽²⁾ Non-monitored start					

TM3 Transmitter and Receiver Modules

The following table shows the TM3 transmitter and receiver expansion modules:

Reference	Description	Terminal Type / Pitch
TM3XTRA1	Data transmitter module for remote I/O	1 front connector RJ-45 1 screw for functional ground connection
TM3XREC1	Data receiver module for remote I/O	1 front connector RJ-45 Power supply connector / 5.08 mm

TM3 Bus Couplers

Introduction

The TM3 bus coupler is a device designed to manage fieldbus communication when using TM2 and TM3 expansion modules in a distributed architecture.

For more information, refer to the Modicon TM3 Bus Coupler Hardware Guide (see Modicon TM3 Bus Coupler, Hardware Guide).

Modicon TM3 Bus Couplers

The following table shows the TM3 bus couplers, with ports and terminal types:

Reference	Port	Communication type	Terminal type
TM3BCEIP	2 isolated switched Ethernet ports	EtherNet/IP Modbus TCP	RJ45
	1 USB port	USB 2.0	USB mini-B
TM3BCSL	2 isolated RS-485 ports (daisy-chained)	Serial Line Modbus	RJ45
	1 USB port	USB 2.0	USB mini-B
TM3BCCO	2 isolated CANopen ports (daisy-chained)	CANopen	RJ45
	1 USB port	USB 2.0	USB mini-B

TM4 Expansion Modules

Introduction

The range of TM4 expansion modules includes communication modules.

For more information, refer to the TM4 Expansion Modules Hardware Guide.

TM4 Expansion Modules

The following table shows the TM4 expansion module features:

Module reference	Type	Terminal type
TM4ES4	Ethernet communication	4 RJ45 connectors 1 screw for functional ground connection
TM4PDPS1	PROFIBUS DP slave communication	1 SUB-D 9 pins female connector 1 screw for functional ground connection
NOTE: The TM4ES4 module has two applications: expansion or standalone. For more information, refer to TM4 Compatibility.		

TM5 Fieldbus Interfaces

Introduction

The TM5 fieldbus interfaces are devices designed to manage EtherNet/IP communication when using TM5 System and TM7 expansion modules with a controller in a distributed architecture.

For more information, refer to the Modicon TM5 System Interface – Hardware Guide.

TM5 Fieldbus Interfaces

The following table shows the TM5 fieldbus interfaces with ports and terminal type:

Reference	Port	Communication type	Terminal type
TM5NEIP1	2 Ethernet switched ports	EtherNet/IP	RJ45

TM5 CANopen Fieldbus Interfaces

Introduction

The TM5 fieldbus module is a CANopen interface with built-in power distribution and is the first TM5 distributed I/O island.

For more information, refer to the Modicon TM5 CANopen Interface Hardware Guide.

Modicon TM5 CANopen Fieldbus Interfaces

The following table shows the TM5 CANopen fieldbus interfaces:

Reference	Communication type	Terminal type
TM5NCO1	CANopen	1 SUB-D 9, male

TM7 CANopen Fieldbus Interfaces

Introduction

The TM7 fieldbus modules are CANopen interfaces with 24 Vdc digital configurable input or output on 8 or 16 channels.

For more information, refer to the Modicon TM7 CANopen Interface I/O Blocks Hardware Guide.

Modicon TM7 CANopen Fieldbus Interfaces

The following table shows the TM7 CANopen fieldbus interfaces:

Reference	Number of channels	Voltage/Current	Communication type	Terminal type
TM7NCOM08B	8 inputs	24 Vdc / 4 mA	CANopen	M8 Connector
	8 outputs	24 Vdc / 500 mA		
TM7NCOM16A	16 inputs	24 Vdc / 4 mA	CANopen	M8 Connector
	16 outputs	24 Vdc / 500 mA		
TM7NCOM16B	16 inputs	24 Vdc / 4 mA	CANopen	M12 Connector
	16 outputs	24 Vdc / 500 mA		

Accessories

Overview

This section describes the accessories and cables.

Accessories

Reference	Description	Use	Quantity
TMASD1	SD Card, page 39	Use to update the controller firmware, initialize a controller with a new application or clone a controller, manage user files, etc.,.	1
TMAT2PSET	Set of 5 removable screw terminal block	Connects 24 Vdc power supply.	1
NSYTRAAB35	End brackets	Helps secure the controller or receiver module and their expansion modules on a top hat section rail (DIN rail).	1
TM2XMTGB	Grounding Bar	Connects the cable shield and the module to the functional ground.	1
TM200RSRCEMC	Shielding take-up clip	Mounts and connects the ground to the cable shielding.	25 pack

Cables

Reference	Description	Details	Length
TCSXCNAMUM3P	Terminal port/USB port cordset	From the USB mini-B port on the M251 Logic Controller to USB port on the PC terminal.	3 m (10 ft)
TCSMCN3M4F3C2	RS-232 serial link cordset 1 RJ45 connector and 1 SUB-D 9 connector	For DTE terminal (printer).	3 m (9.84 ft)
TCSMCN3M4M3S2	RS-232 serial link cordset 1 RJ45 connector and 1 SUB-D 9 connector	For DCE terminal (modem, converter).	3 m (9.84 ft)
490NTW000**	Ethernet shielded cable for DTE connections	Standard cable, equipped with RJ45 connectors at each end for DTE. CE compliant.	2, 5, 12, 40, or 80 m (6.56, 16.4, 39.37, 131.23 or 262.47 ft)
490NTW000**U		Standard cable, equipped with RJ45 connectors at each end for DTE. UL compliant.	2, 5, 12, 40, or 80 m (6.56, 16.4, 39.37, 131.23, or 262.47 ft)
TCSECE3M3M**S4		Cable for harsh environment, equipped with RJ45 connectors at each end. CE compliant.	1, 2, 3, 5, or 10 m (3.28, 6.56, 9.84, 16.4, 32.81 ft)
TCSECU3M3M**S4		Cable for harsh environment, equipped with RJ45 connectors at each end. UL compliant.	1, 2, 3, 5, or 10 m (3.28, 6.56, 9.84, 16.4, 32.81 ft)
VW3A8306R**		2 RJ45 connectors	Cable equipped with RJ45 connectors at each end for Modbus serial link.

M251 Features

What's in This Chapter

Real Time Clock (RTC).....	35
Run/Stop	38
SD Card	39

Overview

This chapter describes the Modicon M251 Logic Controller features.

Real Time Clock (RTC)

Overview

The M251 Logic Controller includes an RTC to provide system date and time information, and to support related functions requiring a real-time clock. To continue keeping time when power is off, a non-rechargeable battery is required (see reference below). A battery LED on the front panel of the controller indicates if the battery is depleted or absent.

This table shows how RTC drift is managed:

RTC Characteristics	Description
RTC drift	Less than 60 seconds per month without any user calibration at 25 °C (77 °F)

Battery

The controller has one battery.

In the event of a power interruption, the backup battery maintains the RTC for the controller.

This table shows the characteristics of the battery:

Characteristics	Description
Use	In the event of a transient power outage, the battery powers the RTC.
Backup life	At least 2 years at 25 °C maximum (77 °F). At higher temperatures, the time is reduced.
Battery monitoring	Yes
Replaceable	Yes
Controller battery type	Lithium carbon monofluoride, type Panasonic BR2032

Installing and Replacing the Battery

While lithium batteries are preferred due to their slow discharge and long life, they can present hazards to personnel, equipment and the environment and must be handled properly.

⚠ DANGER

EXPLOSION, FIRE, OR CHEMICAL BURNS

- Replace with identical battery type.
- Follow all the instructions of the battery manufacturer.
- Remove all replaceable batteries before discarding unit.
- Recycle or properly dispose of used batteries.
- Protect battery from any potential short-circuit.
- Do not recharge, disassemble, heat above 100 °C (212 °F), or incinerate.
- Use your hands or insulated tools to remove or replace the battery.
- Maintain proper polarity when inserting and connecting a new battery.

Failure to follow these instructions will result in death or serious injury.

To install or replace the battery, follow these steps:

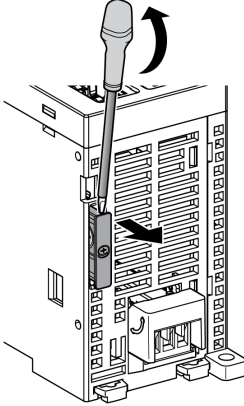
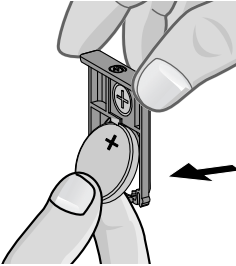
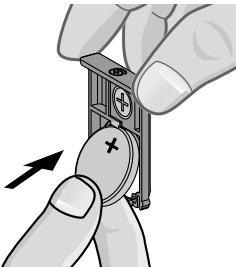
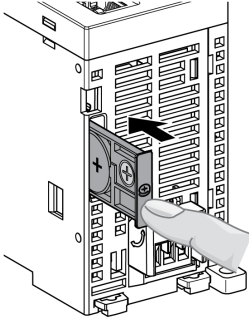
Step	Action
1	Remove power from your controller.
2	Use an insulated screw-driver to pull out the battery holder. 
3	Slide out the battery holder of the controller.
4	Remove the battery from the battery holder. 
5	Insert the new battery into the battery holder in accordance with the polarity markings on the battery. 
6	Slide in the battery holder of the controller and verify that the latch clicks into place. 
7	Power up your M251 Logic Controller.
8	Set the internal clock. For further details on the internal clock, refer to M251 Logic Controller Programming Guide (see Modicon M251 Logic Controller, Programming Guide).

NOTE: Replacement of the battery in the controllers other than with the type specified in this documentation may present a risk of fire or explosion.

⚠ WARNING

IMPROPER BATTERY CAN PROVOKE FIRE OR EXPLOSION

Replace battery only with identical type: Panasonic Type BR2032.

Failure to follow these instructions can result in death, serious injury, or equipment damage.

Run/Stop

Overview

The M251 Logic Controller can be operated externally by the following:

- A hardware Run/Stop switch.
- An EcoStruxure Machine Expert software command.
- The system variable PLC_W in a Relocation Table (see Modicon M251 Logic Controller, Programming Guide).
- The Web server (see Modicon M251 Logic Controller, Programming Guide).

The M251 Logic Controller has a Run/Stop hardware switch, which puts the controller in a RUNNING or STOPPED state.

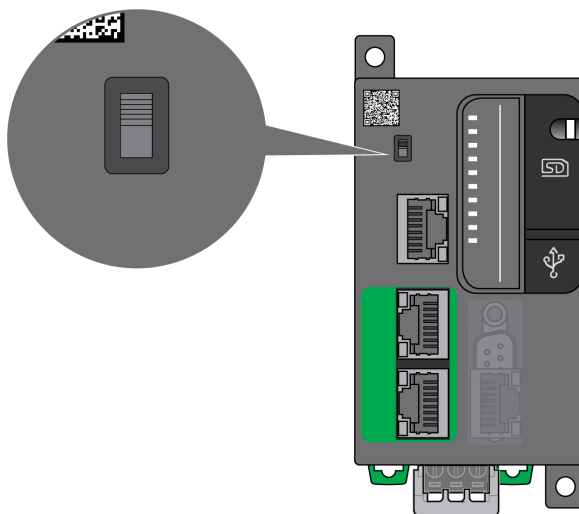

SD Card

Overview

When handling the SD card, follow the instructions below to help prevent internal data on the SD card from being corrupted or lost or an SD card malfunction from occurring:

NOTICE

LOSS OF APPLICATION DATA

- Do not store the SD card where there is static electricity or probable electromagnetic fields.
- Do not store the SD card in direct sunlight, near a heater, or other locations where high temperatures can occur.
- Do not bend the SD card.
- Do not drop or strike the SD card against another object.
- Keep the SD card dry.
- Do not touch the SD card connectors.
- Do not disassemble or modify the SD card.
- Use only SD cards formatted using FAT or FAT32.

Failure to follow these instructions can result in equipment damage.

The M251 Logic Controller does not recognize NTFS formatted SD cards. Format the SD card on your computer using FAT or FAT32.

When using the M251 Logic Controller and an SD card, observe the following to avoid losing valuable data:

- Accidental data loss can occur at any time. Once data is lost it cannot be recovered.
- If you forcibly extract the SD card, data on the SD card may become corrupted.
- Removing an SD card that is being accessed could damage the SD card, or corrupt its data.
- If the SD card is not positioned correctly when inserted into the controller, the data on the card and the controller could become damaged.

NOTICE

LOSS OF APPLICATION DATA

- Backup SD card data regularly.
- Do not remove power or reset the controller, and do not insert or remove the SD card while it is being accessed.

Failure to follow these instructions can result in equipment damage.

This figure shows the SD card slot:

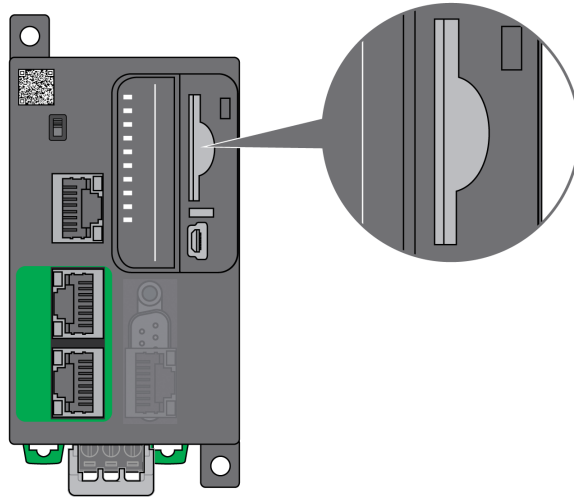

It is possible to set the Write-Control Tab to prevent write operations to the SD card. Push the tab up, as shown in the example on the right-hand side, to release the lock and enable writing to the SD card. Before using an SD card, read the manufacturer's instructions.

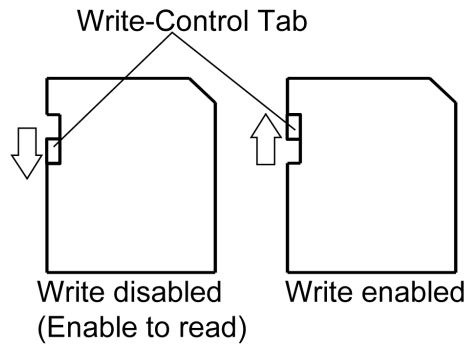

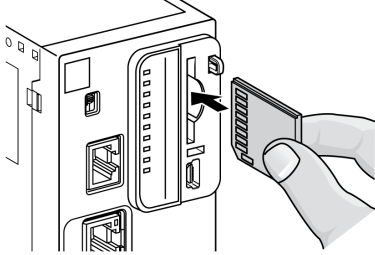
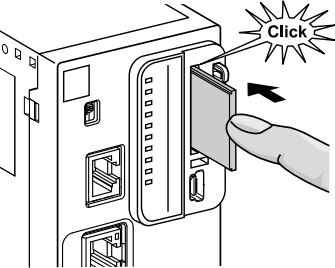
Step	Action
1	Insert the SD card into the SD card slot: 
2	Push until you hear it "click": 

SD Card Slot Characteristics

Topic	Characteristics	Description
Supported type	Standard Capacity	SD (SDSC)
	High Capacity	SDHC
Global memory	Size	16 GB max.

TMASD1 Characteristics

Characteristics	Description
Card removal durability	Minimum 1000 times
File retention time	10 years @ 25 °C (77 °F)
Flash type	SLC NAND
Memory size	256 MB
Ambient operation temperature	-10 ... +85°C (14...185 °F)
Storage temperature	-25 ... +85°C (-13...185 °F)
Relative humidity	95% max. non-condensing
Write/Erase cycles	3,000,000 (approximately)

M251 Installation

What's in This Chapter

M251 Logic Controller General Rules for Implementing	42
M251 Logic Controller Installation	45
M251 Electrical Requirements	54

Overview

This chapter provides installation safety guidelines, device dimensions, mounting instructions, and environmental specifications.

M251 Logic Controller General Rules for Implementing

Environmental Characteristics

Enclosure Requirements

M251 Logic Controller system components are designed as Zone B, Class A industrial equipment according to IEC/CISPR Publication 11. If they are used in environments other than those described in the standard, or in environments that do not meet the specifications in this manual, the ability to meet electromagnetic compatibility requirements in the presence of conducted and/or radiated interference may be reduced.

All M251 Logic Controller system components meet European Community (CE) requirements for open equipment as defined by IEC/EN 61131-2. You must install them in an enclosure designed for the specific environmental conditions and to minimize the possibility of unintended contact with hazardous voltages. Use metal enclosures to improve the electromagnetic immunity of your M251 Logic Controller system. Use enclosures with a keyed locking mechanism to minimize unauthorized access.

Environmental Characteristics

All the M251 Logic Controller module components are electrically isolated between the internal electronic circuit and the input/output channels within the limits set forth and described by these environmental characteristics. For more information on electrical isolation, see the technical specifications of your particular controller found later in the current document. This equipment meets CE requirements as indicated in the table below. This equipment is intended for use in a Pollution Degree 2 industrial environment.

⚠ WARNING

UNINTENDED EQUIPMENT OPERATION

Do not exceed any of the rated values specified in the environmental and electrical characteristics tables.

Failure to follow these instructions can result in death, serious injury, or equipment damage.

The following table shows the general environmental characteristics:

Characteristic	Minimum Specification	Tested Range	
Standard compliance	IEC/EN 61131-2 IEC/EN 61010-2-201	–	
Ambient operating temperature	–	Horizontal installation	–10...55 °C (14...131 °F)
	–	Vertical installation	–10...35 °C (14...95 °F)
Storage temperature	–	–25...70 °C (- 13...158 °F)	
Relative humidity	–	Transport and storage	10...95 % (non-condensing)
		Operation	10...95 % (non-condensing)
Degree of pollution	IEC/EN 60664-1	2	
Degree of protection	IEC/EN 61131-2	IP20 with protective covers in place	
Corrosion immunity	–	Atmosphere free from corrosive gases	
Operating altitude	–	0...2000 m (0...6560 ft)	
Storage altitude	–	0...3000 m (0...9843 ft)	
Vibration resistance	IEC/EN 61131-2	Panel mounting or mounted on a top hat section rail (DIN rail)	3.5 mm (0.13 in) fixed amplitude from 5...8.4 Hz 9.8 m/s ² (32.15 ft/s ²) (1 g _n) fixed acceleration from 8.4...150 Hz 10 mm (0.39 in) fixed amplitude from 5...8.7 Hz 29.4 m/s ² (96.45 ft/s ²) (3 g _n) fixed acceleration from 8.7...150 Hz
Mechanical shock resistance	–	147 m/s ² or 482.28 ft/s ² (15 g _n) for a duration of 11 ms	
<p>NOTE: The tested ranges may indicate values beyond that of the IEC Standard. However, our internal standards define what is necessary for industrial environments. In all cases, we uphold the minimum specification if indicated.</p>			

Electromagnetic Susceptibility

The M251 Logic Controller system meets electromagnetic susceptibility specifications as indicated in the following table:

Characteristic	Minimum Specification	Tested Range		
Electrostatic discharge	IEC/EN 61000-4-2	8 kV (air discharge)		
	IEC/EN 61131-2	4 kV (contact discharge)		
Radiated electromagnetic field	IEC/EN 61000-4-3	10 V/m (80...1000 MHz)		
	IEC/EN 61131-2	3 V/m (1.4...2 GHz)		
		1 V/m (2...3 GHz)		
Fast transients burst	IEC/EN 61000-4-4 IEC/EN 61131-2	24 Vdc main power lines	2 kV (CM ¹ and DM ²)	
		24 Vdc I/Os	2 kV (clamp)	
		Relay output	1 kV (clamp)	
		Digital I/Os	1 kV (clamp)	
		Communication line	1 kV (clamp)	
Surge immunity	IEC/EN 61000-4-5 IEC/EN 61131-2	–	CM ¹	DM ²
		DC Power lines	0.5 kV	0.5 kV
		Relay Outputs	–	–
		24 Vdc I/Os	–	–
		Shielded cable (between shield and ground)	1 kV	–
Induced electromagnetic field	IEC/EN 61000-4-6 IEC/EN 61131-2	10 Vrms (0.15...80 MHz)		
Conducted emission	IEC 61000-6-4 IEC/EN 61131-2	• 10...150 kHz: 120...69 dB μ V/m QP		
		• 150...1500 kHz: 79...63 dB μ V/m QP		
		• 1.5...30 MHz: 63 dB μ V/m QP		
Radiated emission	IEC 61000-6-4	30...230 MHz: 40 dB μ V/m QP		
	IEC/EN 61131-2	230...1000 MHz: 47 dB μ V/m QP		
1 Common Mode 2 Differential Mode NOTE: The tested ranges may indicate values beyond that of the IEC Standard. However, our internal standards define what is necessary for industrial environments. In all cases, we uphold the minimum specification if indicated.				

Certifications and Standards

Introduction

For information on certifications and conformance to standards, go to www.se.com.

For product compliance and environmental information (RoHS, REACH, PEP, EOL, etc.), go to www.se.com/green-premium.

M251 Logic Controller Installation

Installation and Maintenance Requirements

Before Starting

Read and understand this chapter before beginning the installation of your system.

The use and application of the information contained herein require expertise in the design and programming of automated control systems. Only you, the user, machine builder or integrator, can be aware of all the conditions and factors present during installation and setup, operation, and maintenance of the machine or process, and can therefore determine the automation and associated equipment and the related safeties and interlocks which can be effectively and properly used. When selecting automation and control equipment, and any other related equipment or software, for a particular application, you must also consider any applicable local, regional or national standards and/or regulations.

Pay particular attention in conforming to any safety information, different electrical requirements, and normative standards that would apply to your machine or process in the use of this equipment.

Disconnecting Power

All options and modules should be assembled and installed before installing the control system on a mounting rail, onto a mounting plate or in a panel. Remove the control system from its mounting rail, mounting plate or panel before disassembling the equipment.

DANGER

HAZARD OF ELECTRIC SHOCK, EXPLOSION OR ARC FLASH

- Disconnect all power from all equipment including connected devices prior to removing any covers or doors, or installing or removing any accessories, hardware, cables, or wires except under the specific conditions specified in the appropriate hardware guide for this equipment.
- Always use a properly rated voltage sensing device to confirm the power is off where and when indicated.
- Replace and secure all covers, accessories, hardware, cables, and wires and confirm that a proper ground connection exists before applying power to the unit.
- Use only the specified voltage when operating this equipment and any associated products.

Failure to follow these instructions will result in death or serious injury.

Programming Considerations

WARNING

UNINTENDED EQUIPMENT OPERATION

- Only use software approved by Schneider Electric for use with this equipment.
- Update your application program every time you change the physical hardware configuration.

Failure to follow these instructions can result in death, serious injury, or equipment damage.

Operating Environment

In addition to the **Environmental Characteristics**, refer to **Product Related Information** in the beginning of the present document for important information regarding installation in hazardous locations for this specific equipment.

⚠ WARNING

UNINTENDED EQUIPMENT OPERATION

Install and operate this equipment according to the conditions described in the Environmental Characteristics.

Failure to follow these instructions can result in death, serious injury, or equipment damage.

Installation Considerations

⚠ WARNING

UNINTENDED EQUIPMENT OPERATION

- Use appropriate safety interlocks where personnel and/or equipment hazards exist.
- Install and operate this equipment in an enclosure appropriately rated for its intended environment and secured by a keyed or tooled locking mechanism.
- Use the sensor and actuator power supplies only for supplying power to the sensors or actuators connected to the module.
- Power line and output circuits must be wired and fused in compliance with local and national regulatory requirements for the rated current and voltage of the particular equipment.
- Do not use this equipment in safety-critical machine functions unless the equipment is otherwise designated as functional safety equipment and conforming to applicable regulations and standards.
- Do not disassemble, repair, or modify this equipment.
- Do not connect any wiring to reserved, unused connections, or to connections designated as No Connection (N.C.).

Failure to follow these instructions can result in death, serious injury, or equipment damage.

NOTE: JDYX2 or JDYX8 fuse types are UL-recognized and CSA approved.

M251 Logic Controller Mounting Positions and Clearances

Introduction

This section describes the correct mounting positions for the M251 Logic Controller.

NOTE: Keep adequate spacing for proper ventilation and to maintain the operating temperature specified in the Environmental Characteristics, page 42.

Correct Mounting Position

To obtain optimal operating characteristics, the M251 Logic Controller should be mounted horizontally on a vertical plane as shown in the figure below:

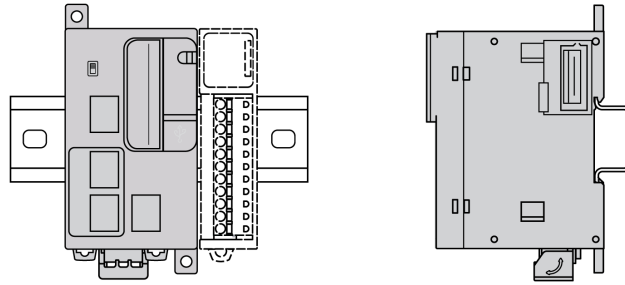

Acceptable Mounting Positions

The M251 Logic Controller can also be mounted vertically on a vertical plane as shown below.

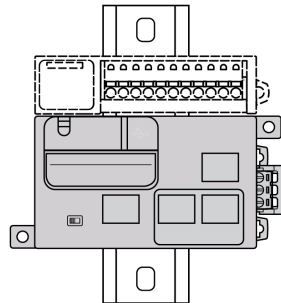

NOTE: Expansion modules must be mounted above the controller.

Incorrect Mounting Position

The M251 Logic Controller should only be positioned as shown in the Correct Mounting Position figure. The figures below show the incorrect mounting positions.

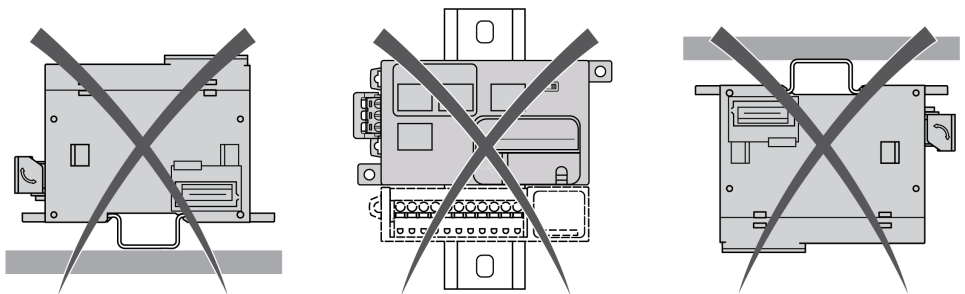

Minimum Clearances

⚠ WARNING

UNINTENDED EQUIPMENT OPERATION

- Place devices dissipating the most heat at the top of the cabinet and ensure adequate ventilation.
- Avoid placing this equipment next to or above devices that might cause overheating.
- Install the equipment in a location providing the minimum clearances from all adjacent structures and equipment as directed in this document.
- Install all equipment in accordance with the specifications in the related documentation.

Failure to follow these instructions can result in death, serious injury, or equipment damage.

The M251 Logic Controller has been designed as an IP20 product and must be installed in an enclosure. Clearances must be respected when installing the product.

There are 3 types of clearances to consider:

- The M251 Logic Controller and all sides of the cabinet (including the panel door).
- The M251 Logic Controller terminal blocks and the wiring ducts to help reduce potential electromagnetic interference between the controller and the duct wiring.
- The M251 Logic Controller and other heat generating devices installed in the same cabinet.

The following figure shows the minimum clearances that apply to all M251 Logic Controller references:

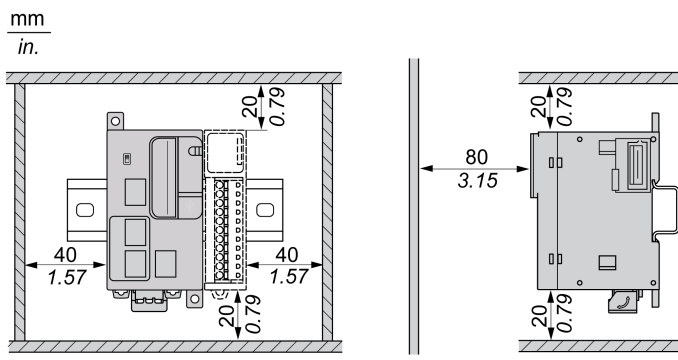

Top Hat Section Rail (DIN rail)

Dimensions of Top Hat Section Rail DIN Rail

You can mount the controller or receiver and their expansions on a 35 mm (1.38 in.) top hat section rail (DIN rail). The DIN rail can be attached to a smooth mounting surface or suspended from a EIA rack or mounted in a NEMA cabinet.

Symmetric Top Hat Section Rails (DIN Rail)

The following illustration and table indicate the references of the top hat section rails (DIN rail) for the wall-mounting range:

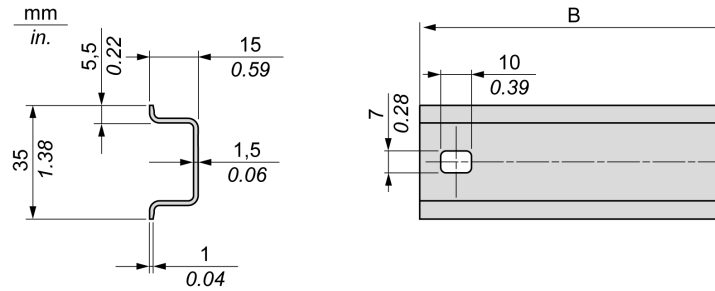

Reference	Type	Rail Length (B)
NSYS DR50A	A	450 mm (17.71 in.)
NSYS DR60A	A	550 mm (21.65 in.)
NSYS DR80A	A	750 mm (29.52 in.)
NSYS DR100A	A	950 mm (37.40 in.)

The following illustration and table indicate the references of the symmetric top hat section rails (DIN rail) for the metal enclosure range:

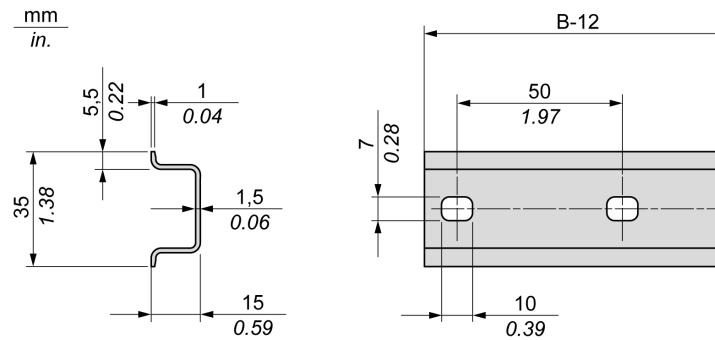

Reference	Type	Rail Length (B-12 mm)
NSYS DR60	A	588 mm (23.15 in.)
NSYS DR80	A	788 mm (31.02 in.)
NSYS DR100	A	988 mm (38.89 in.)
NSYS DR120	A	1188 mm (46.77 in.)

The following illustration and table indicate the references of the symmetric top hat section rails (DIN rail) of 2000 mm (78.74 in.):

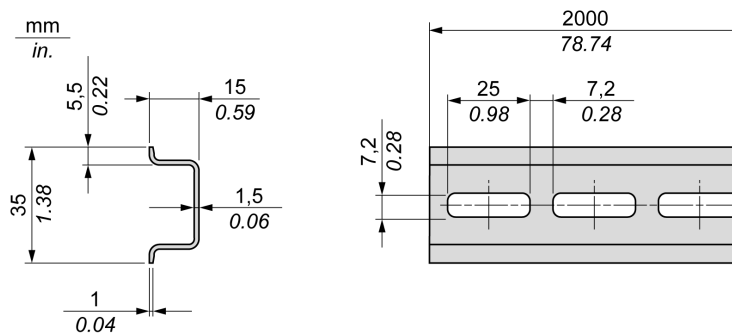

Reference	Type	Rail Length
NSYSDR200 ¹	A	2000 mm (78.74 in.)
NSYSDR200D ²	A	
¹ Unperforated galvanized steel ² Perforated galvanized steel		

Double-Profile Top Hat Section Rails (DIN rail)

The following illustration and table indicate the references of the double-profile top hat section rails (DIN rails) for the wall-mounting range:

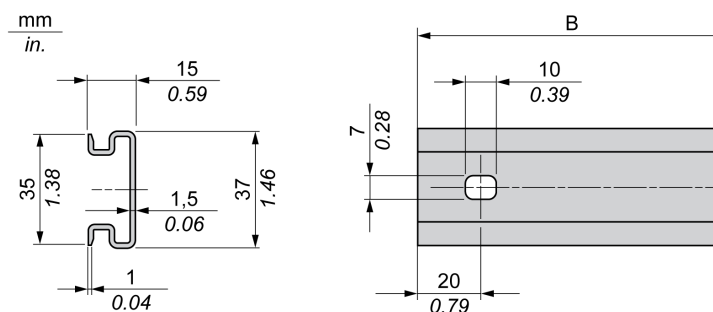

Reference	Type	Rail Length (B)
NSYDPR25	W	250 mm (9.84 in.)
NSYDPR35	W	350 mm (13.77 in.)
NSYDPR45	W	450 mm (17.71 in.)
NSYDPR55	W	550 mm (21.65 in.)
NSYDPR65	W	650 mm (25.60 in.)
NSYDPR75	W	750 mm (29.52 in.)

The following illustration and table indicate the references of the double-profile top hat section rails (DIN rail) for the floor-standing range:

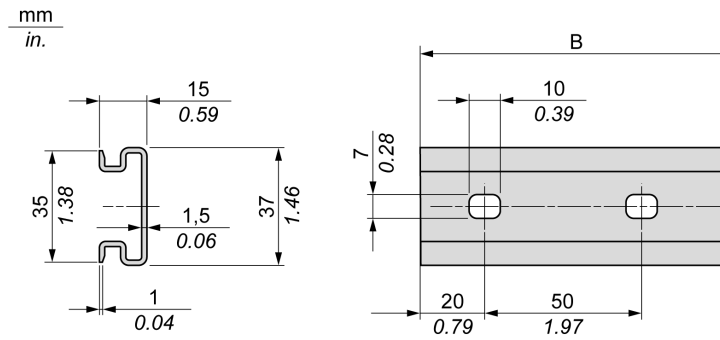

Reference	Type	Rail Length (B)
NSYDPR60	F	588 mm (23.15 in.)
NSYDPR80	F	788 mm (31.02 in.)
NSYDPR100	F	988 mm (38.89 in.)
NSYDPR120	F	1188 mm (46.77 in.)

Installing and Removing the Controller with Expansions

Overview

This section describes how to install and remove the controller with its expansion modules from a top hat section rail (DIN rail).

To assemble expansion modules to a controller or receiver module, or to other modules, refer to the respective expansion modules hardware guide(s).

Installing a Controller with its Expansions on a DIN Rail

The following procedure describes how to install a controller with its expansion modules on a top hat section rail (DIN rail):

Step	Action
1	Fasten the top hat section rail (DIN rail) to a panel surface using screws.
2	Position the top groove of the controller and its expansion modules on the top edge of the DIN rail and press the assembly against the top hat section rail (DIN rail) until you hear the top hat section rail (DIN rail) clip snap into place. <div data-bbox="630 465 960 788" data-label="Image"> </div>
3	Place 2 terminal block end clamps on both sides of the controller and expansion module assembly. <div data-bbox="667 907 992 1142" data-label="Image"> </div> <p>NOTE: Type NSYTRAAB35 or equivalent terminal block end clamps help minimize sideways movement and improve the shock and vibration characteristics of the controller and expansion module assembly.</p>

Removing a Controller with its Expansions from a Top Hat Section Rail (DIN Rail)

The following procedure describes how to remove a controller with its expansion modules from a top hat section rail (DIN rail):

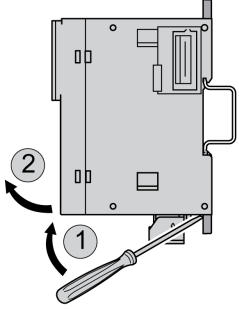
Step	Action
1	Remove all power from your controller and expansion modules.
2	Insert a flat screwdriver into the slot of the top hat section rail (DIN rail) clip. 
3	Pull down the DIN rail clip.
4	Pull the controller and its expansion modules from the top hat section rail (DIN rail) from the bottom.

Direct Mounting on a Panel Surface

Overview

This section shows how to install M251 Logic Controller on a panel surface using the mounting holes.

Mounting Hole Layout

This diagram shows the mounting hole layout for M251 Logic Controller:

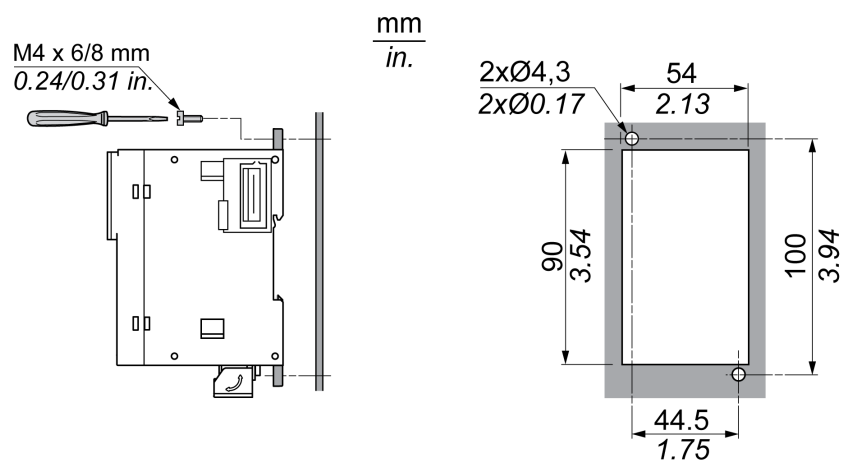

M251 Electrical Requirements

Wiring Best Practices

Overview

This section describes the wiring guidelines and associated best practices to be respected when using the M251 Logic Controller system.

DANGER

HAZARD OF ELECTRIC SHOCK, EXPLOSION OR ARC FLASH

- Disconnect all power from all equipment including connected devices prior to removing any covers or doors, or installing or removing any accessories, hardware, cables, or wires except under the specific conditions specified in the appropriate hardware guide for this equipment.
- Always use a properly rated voltage sensing device to confirm the power is off where and when indicated.
- Replace and secure all covers, accessories, hardware, cables, and wires and confirm that a proper ground connection exists before applying power to the unit.
- Use only the specified voltage when operating this equipment and any associated products.

Failure to follow these instructions will result in death or serious injury.

WARNING

LOSS OF CONTROL

- The designer of any control scheme must consider the potential failure modes of control paths and, for certain critical control functions, provide a means to achieve a safe state during and after a path failure. Examples of critical control functions are emergency stop and overtravel stop, power outage and restart.
- Separate or redundant control paths must be provided for critical control functions.
- System control paths may include communication links. Consideration must be given to the implications of unanticipated transmission delays or failures of the link.
- Observe all accident prevention regulations and local safety guidelines.¹
- Each implementation of this equipment must be individually and thoroughly tested for proper operation before being placed into service.

Failure to follow these instructions can result in death, serious injury, or equipment damage.

¹ For additional information, refer to NEMA ICS 1.1 (latest edition), "Safety Guidelines for the Application, Installation, and Maintenance of Solid State Control" and to NEMA ICS 7.1 (latest edition), "Safety Standards for Construction and Guide for Selection, Installation and Operation of Adjustable-Speed Drive Systems" or their equivalent governing your particular location.

Wiring Guidelines

This rules must be applied when wiring an M251 Logic Controller system:

- Communication wiring must be kept separate from the power wiring. Route these 2 types of wiring in separate cable ducting.
- Verify that the operating conditions and environment are within the specification values.
- Use proper wire sizes to meet voltage and current requirements.
- Use copper conductors (required).
- Use twisted pair, shielded cables for networks, and fieldbus.

Use shielded, properly grounded cables for all communication connections. If you do not use shielded cable for these connections, electromagnetic interference can cause signal degradation. Degraded signals can cause the controller or attached modules and equipment to perform in an unintended manner.

⚠ WARNING

UNINTENDED EQUIPMENT OPERATION

- Use shielded cables for all communication signals.
- Ground cable shields for all communication signals at a single point¹.
- Route communication separately from power cables.

Failure to follow these instructions can result in death, serious injury, or equipment damage.

¹Multipoint grounding is permissible if connections are made to an equipotential ground plane dimensioned to help avoid cable shield damage in the event of power system short-circuit currents.









For more details, refer to *Grounding Shielded Cables*, page 59.

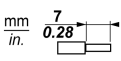

NOTE: Surface temperatures may exceed 60 °C (140 °F).

To conform to IEC 61010 standards, route primary wiring (wires connected to power mains) separately and apart from secondary wiring (extra low voltage wiring coming from intervening power sources). If that is not possible, double insulation is required such as conduit or cable gains.

Rules for Removable Screw Terminal Block

The following tables show the cable types and wire sizes for a **5.08 pitch** removable screw terminal block (power supply):

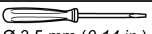
								
mm ²	0.2...2.5	0.2...2.5	0.25...2.5	0.25...2.5	2 x 0.2...1	2 x 0.2...1.5	2 x 0.25...1	2 x 0.5...1.5
AWG	24...14	24...14	23...14	23...14	2 x 24...17	2 x 24...16	2 x 23...17	2 x 20...16

		N•m	0.5...0.6
Ø 3,5 mm (0.14 in.)		lb-in	4.42...5.31

The use of copper conductors is required.

⚠⚠ DANGER

LOOSE WIRING CAUSES ELECTRIC SHOCK

Tighten connections in conformance with the torque specifications.

Failure to follow these instructions will result in death or serious injury.

⚠ DANGER**FIRE HAZARD**

Use only the correct wire sizes for the maximum current capacity of the power supplies.

Failure to follow these instructions will result in death or serious injury.

DC Power Supply Characteristics and Wiring

Overview

This section provides the characteristics and the wiring diagrams of the DC power supply.

DC Power Supply Voltage Range

If the specified voltage range is not maintained, outputs may not switch as expected. Use appropriate safety interlocks and voltage monitoring circuits.

⚠ DANGER**FIRE HAZARD**

- Use only the correct wire sizes for the maximum current capacity of the I/O channels and power supplies.
- For relay output (2 A) wiring, use conductors of at least 0.5 mm² (AWG 20) with a temperature rating of at least 80 °C (176 °F).
- For common conductors of relay output wiring (7 A), or relay output wiring greater than 2 A, use conductors of at least 1.0 mm² (AWG 16) with a temperature rating of at least 80 °C (176 °F).

Failure to follow these instructions will result in death or serious injury.

⚠ WARNING**UNINTENDED EQUIPMENT OPERATION**

Do not exceed any of the rated values specified in the environmental and electrical characteristics tables.

Failure to follow these instructions can result in death, serious injury, or equipment damage.

DC Power Supply Requirements

The M251 Logic Controller and associated I/O (TM2, TM3, with a nominal voltage of 24 Vdc. The 24 Vdc power supplies must be rated Safety Extra Low Voltage (SELV) or Protective Extra Low Voltage (PELV) according to IEC 61140. These power supplies are isolated between the electrical input and output circuits of the power supply.

⚠ WARNING
<p>POTENTIAL OF OVERHEATING AND FIRE</p> <ul style="list-style-type: none"> • Do not connect the equipment directly to line voltage. • Use only isolating PELV power supplies and circuits to supply power to the equipment¹. <p>Failure to follow these instructions can result in death, serious injury, or equipment damage.</p>

¹ For compliance to UL (Underwriters Laboratories) requirements, the power supply must also conform to the various criteria of NEC Class 2, and be inherently current limited to a maximum power output availability of less than 100 VA (approximately 4 A at nominal voltage), or not inherently limited but with an additional protection device such as a circuit breaker or fuse meeting the requirements of clause 9.4 Limited-energy circuit of UL 61010-1. In all cases, the current limit should never exceed that of the electric characteristics and wiring diagrams for the equipment described in the present documentation. In all cases, the power supply must be grounded, and you must separate Class 2 circuits from other circuits. If the indicated rating of the electrical characteristics or wiring diagrams are greater than the specified current limit, multiple Class 2 power supplies may be used.

Controller DC Characteristics

This table shows the characteristics of the DC power supply required for the controller:

Characteristic	Value	
Rated voltage	24 Vdc	
Power supply voltage range	19.2...28.8 Vdc	
Power interruption time	10 ms at 24 Vdc	
Maximum inrush current	50 A	
Power consumption	32.6 W, max. 40.4 W ⁽¹⁾	
Isolation	between DC power supply and internal logic	Not isolated
	between DC power supply and protective earth ground (PE)	500 Vac
(1) Controller + 7 TM3 expansion modules		

Power Interruption

The duration of power interruptions where the M251 Logic Controller is able to continue normal operation varies depending upon the load to the power supply of the controller, but a minimum of 10 ms is maintained as specified by IEC standards.

When planning the management of the power supplied to the controller, you must consider the power interruption duration due to the fast cycle time of the controller.

There could potentially be many scans of the logic and consequential updates to the I/O image table during the power interruption, while there is no external power supplied to the inputs, the outputs or both depending on the power system architecture and power interruption circumstances.

⚠ WARNING

UNINTENDED EQUIPMENT OPERATION

- Individually monitor each source of power used in the controller system including input power supplies, output power supplies and the power supply to the controller to allow appropriate system shutdown during power system interruptions.
- The inputs monitoring each of the power supply sources must be unfiltered inputs.

Failure to follow these instructions can result in death, serious injury, or equipment damage.

DC Power Supply Wiring Diagram

This figure shows the power supply terminal block removal procedure:

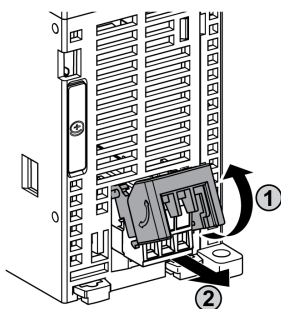

The following figure shows the wiring of the DC power supply:

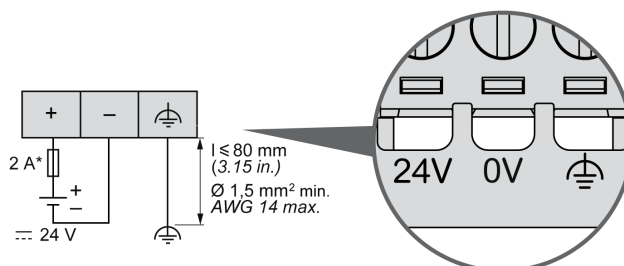

* Type T fuse

For more information, refer to the 5.08 pitch Rules for Removable Screw Terminal block, page 55.

Grounding the M251 System

Overview

To help minimize the effects of electromagnetic interference, cables carrying fieldbus communication signals must be shielded.

⚠ WARNING

UNINTENDED EQUIPMENT OPERATION

- Use shielded cables for communication signals.
- Ground cable shields for communication signals at a single point ¹.
- Always comply with local wiring requirements regarding grounding of cable shields.

Failure to follow these instructions can result in death, serious injury, or equipment damage.

¹Multipoint grounding is permissible if connections are made to an equipotential ground plane dimensioned to help avoid cable shield damage in the event of power system short-circuit currents.

The use of shielded cables requires compliance with the following wiring rules:

- For protective ground connections (PE), metal conduit or ducting can be used for part of the shielding length, provided there is no break in the continuity of the ground connections. For functional ground (FE), the shielding is intended to attenuate electromagnetic interference and the shielding must be continuous for the length of the cable. If the purpose is both functional and protective, as is often the case for communication cables, the cable must have continuous shielding.
- Wherever possible, keep cables carrying one type of signal separate from the cables carrying other types of signals or power.

Protective Ground (PE) on the Backplane

The protective ground (PE) should be connected to the conductive backplane by a heavy-duty wire, usually a braided copper cable with the maximum allowable cable section.

Shielded Cables Connections

Cables carrying fieldbus communication signals must be shielded. The shielding must be securely connected to ground. The fieldbus communication cable shields must be connected to the protective ground (PE) with a connecting clamp secured to the conductive backplane of your installation.

The shielding of the Modbus cable must be connected to the protective ground (PE).

⚠⚠ DANGER

HAZARD OF ELECTRIC SHOCK

- The grounding terminal connection (PE) must be used to provide a protective ground at all times.
- Make sure that an appropriate, braided ground cable is attached to the PE/PG ground terminal before connecting or disconnecting the network cable to the equipment.

Failure to follow these instructions will result in death or serious injury.

⚠ WARNING**ACCIDENTAL DISCONNECTION FROM PROTECTIVE GROUND (PE)**

- Do not use the TM2XMTGB Grounding Plate to provide a protective ground (PE).
- Use the TM2XMTGB Grounding Plate only to provide a functional ground (FE).

Failure to follow these instructions can result in death, serious injury, or equipment damage.

Modicon M251 Logic Controller

What's in This Part

TM251MESC	62
TM251MESE	65

TM251MESC

What's in This Chapter

TM251MESC Presentation 62

Overview

This chapter describes the TM251MESC logic controller.

TM251MESC Presentation

Description

This figure shows the different components of the TM251MESC logic controller:

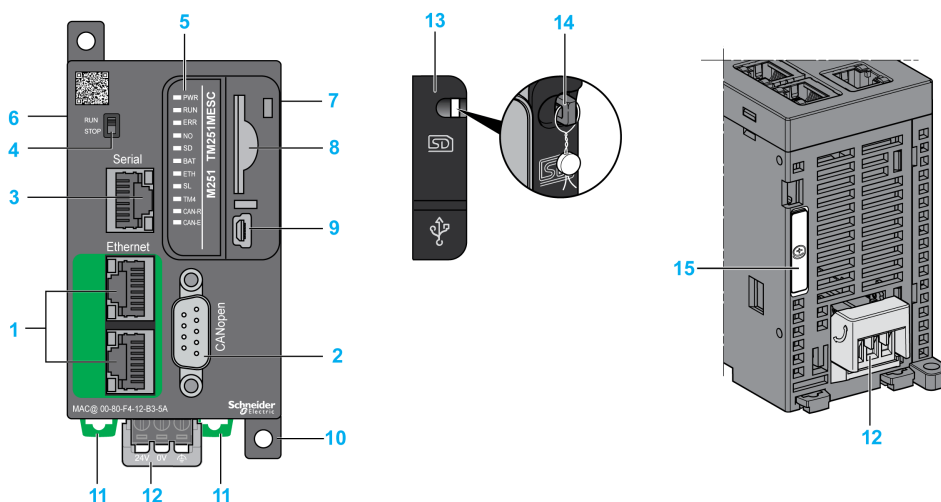

N°	Description	Refer to
1	Dual port Ethernet switch	Ethernet port, page 72
2	CANopen port	CANopen port, page 69
3	Serial line port / Type RJ45 (RS-232 or RS-485)	Serial Line, page 76
4	Run/Stop switch	Run/Stop, page 38
5	Status LEDs	Status LEDs, page 63
6	TM4 bus connector	TM4 Expansion Modules, page 31
7	TM3/TM2 bus connector	TM3 Expansion Modules, page 22
8	SD card slot	SD Card, page 39
9	USB mini-B programming port / For terminal connection to a programming PC (EcoStruxure Machine Expert)	USB Mini-B Programming Port , page 75
10	Surface mounting lugs	–
11	Clip-on lock for 35 mm (1.38 in.) top hat section rail (DIN-rail)	Top Hat Section Rail, page 49
12	24 Vdc power supply	DC Power supply Characteristics and Wiring, page 56
13	Protective cover (SD card slot and USB mini-B programming port)	–
14	Locking hook (Hook not included)	–
15	Battery holder	Real Time Clock (RTC), page 35

Status LEDs

This figure shows the status LEDs:

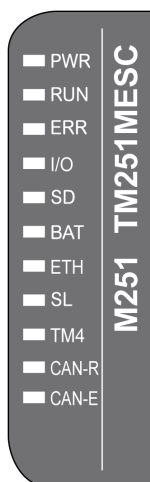

The following table describes the system status LEDs:

Label	Function Type	Color	Status	Description
PWR	Power	Green	On	Indicates that power is applied.
			Off	Indicates that power is removed.
RUN	Machine status	Green	On	Indicates that the controller is running a valid application.
			Flashing	Indicates that the controller has a valid application that is stopped.
			1 flash	Indicates that the controller has paused at BREAKPOINT.
			Off	Indicates that the controller is not programmed
ERR	Internal Error	Red	On	Indicates that an operating system error has been detected
			Fast flashing	Indicates that the controller has detected an internal error
			Slow flashing	Indicates either that a minor error has been detected if RUN is ON or that no application has been detected
I/O	I/O error	Red	On	Indicates device errors on the serial line, SD card, TM4 bus, TM3 bus, Ethernet port(s) or CANopen port.
SD	SD card access	Green	On	Indicates that the SD card is being accessed
BAT	Battery	Red	On	Indicates that the battery needs to be replaced.
			Flashing	Indicates that the battery charge is low.
ETH	Ethernet port status	Green	On	Indicates that the ethernet port is connected and the IP address is defined.
			3 flashes	Indicates that the ethernet port is not connected.
			4 flashes	Indicates that the IP address is already in used.
			5 flashes	Indicates that the module is waiting for BOOTP or DHCP sequence.
			6 flashes	Indicates that the configured IP address is not valid.
SL	Serial line	Green	Flashing	Indicates the status of serial line, page 78
			Off	Indicates no serial communication
TM4	Error on TM4 bus	Red	On	Indicates that an error has been detected on the TM4 bus
			Off	Indicates that no error has been detected on the TM4 bus

Label	Function Type	Color	Status	Description
CAN-R	CANopen running status	Green	On	Indicates that the CANopen bus is operational.
			Off	Indicates that the CANopen master is configured.
			Flashing	Indicates that the CANopen bus is being initialized.
			1 flash per second	Indicates that the CANopen bus is stopped.
CAN-E	CANopen error	Red	On	Indicates that the CANopen bus is stopped (BUS OFF).
			Off	Indicates no CANopen detected error.
			Flashing	Indicates that the CANopen bus is not valid.
			1 flash per second	Indicates that the controller has detected that the maximum number of error frames has been reached or exceeded.
			2 flashes per second	Indicates that the controller has detected either a Node Guarding or a Heartbeat event.

NOTE: All the LEDs flash when the logic controller is being identified. For more details, refer to the EcoStruxure Machine Expert Programming Guide.

Dimensions

This figure shows the external dimensions of the logic controller:

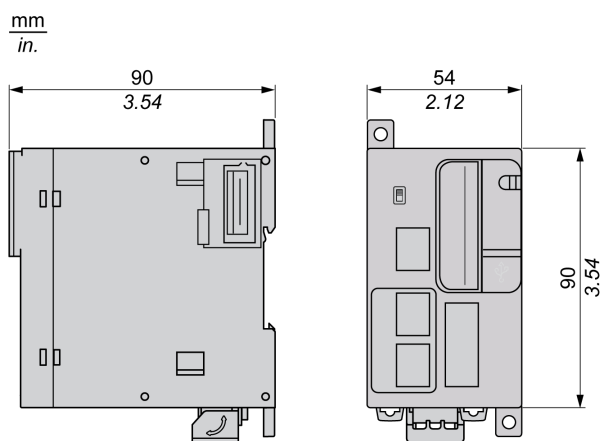

TM251MESE

What's in This Chapter

TM251MESE Presentation..... 65

Overview

This chapter describes the TM251MESE logic controller.

TM251MESE Presentation

Description

This figure shows the different components of the TM251MESE logic controller:

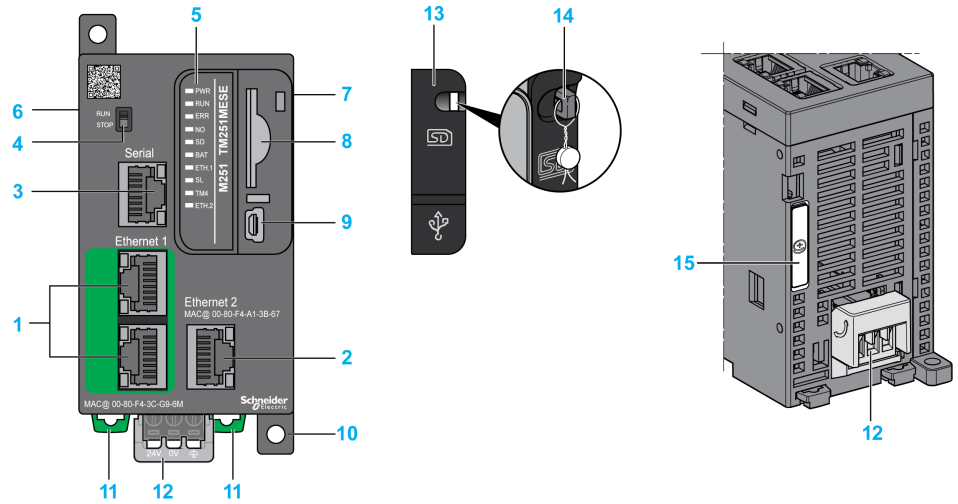

N°	Description	Refer to
1	Dual port Ethernet switch	Ethernet port, page 72
2	Ethernet port 2	Ethernet ports, page 73
3	Serial line port / Type RJ45 (RS-232 or RS-485)	Serial Line, page 76
4	Run/Stop switch	Run/Stop, page 38
5	Status LEDs	Status LEDs, page 66
6	TM4 bus connector	TM4 Expansion Modules, page 31
7	TM3/TM2 bus connector	TM3 Expansion Modules, page 22
8	SD card slot	SD Card, page 39
9	USB mini-B programming port / For terminal connection to a programming PC (EcoStruxure Machine Expert)	USB Mini-B Programming Port , page 75
10	Surface mounting lugs	–
11	Clip-on lock for 35 mm (1.38 in.) top hat section rail (DIN-rail)	Top Hat Section Rail, page 49
12	24 Vdc power supply	DC Power supply Characteristics and Wiring, page 56
13	Protective cover (SD card slot and USB mini-B programming port)	–
14	Locking hook (Hook not included)	–
15	Battery holder	Real Time Clock (RTC), page 35

Status LEDs

This figure shows the status LEDs:

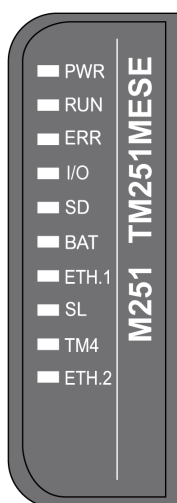

The following table describes the system status LEDs:

Label	Function Type	Color	Status	Description
PWR	Power	Green	On	Indicates that power is applied.
			Off	Indicates that power is removed.
RUN	Machine status	Green	On	Indicates that the controller is running a valid application.
			Flashing	Indicates that the controller has a valid application that is stopped.
			1 flash	Indicates that the controller has paused at BREAKPOINT.
			Off	Indicates that the controller is not programmed
ERR	Internal Error	Red	On	Indicates that an operating system error has been detected
			Fast flashing	Indicates that the controller has detected an internal error
			Slow flashing	Indicates either that a minor error has been detected if RUN is ON or that no application has been detected
I/O	I/O error	Red	On	Indicates device errors on the serial line, SD card, TM4 bus, TM3 bus, Ethernet port(s) or CANopen port.
SD	SD card access	Green	On	Indicates that the SD card is being accessed
BAT	Battery	Red	On	Indicates that the battery needs to be replaced.
			Flashing	Indicates that the battery charge is low.
ETH.1 ETH.2	Ethernet port status	Green	On	Indicates that the Ethernet port is connected and the IP address is defined.
			3 flashes	Indicates that the Ethernet port is not connected.
			4 flashes	Indicates that the IP address is already in use.
			5 flashes	Indicates that the module is waiting for BOOTP or DHCP sequence.
			6 flashes	Indicates that the configured IP address is not valid.
SL	Serial line	Green	Flashing	Indicates the status of serial line, page 78
			Off	Indicates no serial communication
TM4	Error on TM4 bus	Red	On	Indicates that an error has been detected on the TM4 bus
			Off	Indicates that no error has been detected on the TM4 bus

NOTE: All the LEDs flash when the logic controller is being identified. For more details, refer to the EcoStruxure Machine Expert Programming Guide.

Dimensions

This figure shows the external dimensions of the logic controller:

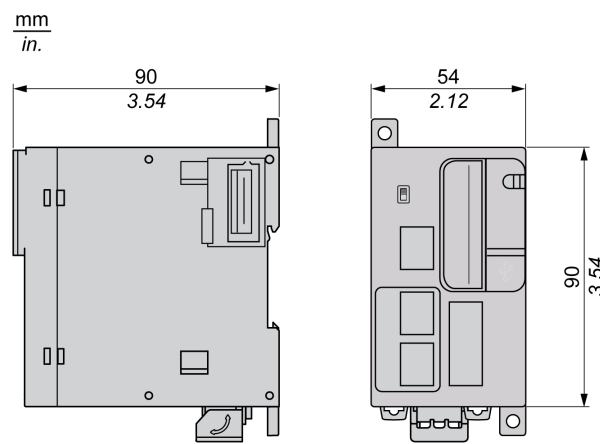

Modicon M251 Logic Controller Communication

What's in This Part

Integrated Communication Ports	69
Connecting the M251 Logic Controller to a PC.....	79

Integrated Communication Ports

What's in This Chapter

CANopen Port.....	69
Ethernet Port	72
TM251MESE Specific Considerations.....	73
USB Mini-B Programming Port	75
Serial Line	76

CANopen Port

CANopen Capabilities

The Modicon M251 Logic Controller CANopen master has the following features:

Feature	Description
Maximum number of slaves on the bus	63 CANopen slave devices
Maximum length of CANopen fieldbus cables	According to the CAN specification (see Transmission Speed and Cable Length, page 71).
Maximum number of PDOs managed by the master	252 TPDOs + 252 RPDOs

For each additional CANopen slave:

- the application size increases by an average of 10 kbytes, which conceivably could result in exceeding memory limits.
- the configuration initialization time at the startup increases, which conceivably could result in watchdog timeout.

Although EcoStruxure Machine Expert does not restrict you from doing so, do not exceed more than 63 CANopen slave modules (and/or 252 TPDOs and 252 RPDOs) in order to have a sufficient performance tolerance and avoid any performance degradation.

⚠ WARNING
UNINTENDED EQUIPMENT OPERATION
Do not connect more than 63 CANopen slave devices to the controller to avoid system overload watchdog condition.
Failure to follow these instructions can result in death, serious injury, or equipment damage.

NOTICE
DEGRADATION OF PERFORMANCE
Do not exceed more than 252 TPDOs and 252 RPDOs for the Modicon M251 Logic Controller.
Failure to follow these instructions can result in equipment damage.

J1939 Capabilities

The Modicon M251 Logic Controller J1939 master has the following features:

Feature	Description
Maximum number of ECUs (slaves) on the bus	Limited only by the address range of 0...253 for Electronic Control Units (ECUs).
Maximum length of J1939 fieldbus cables	According to the CAN specification (see <i>Transmission Speed and Cable Length</i> , page 71). For J1939, the CAN bus must be configured to run at 250 kbps.
Maximum number of PGNs managed by the master	Given implicitly by the maximum number of input bits (%I) and output bits (%Q) available on the Modicon M251 Logic Controller: 4096 input bits and 4096 output bits. This results in a maximum of 512 single-packet PGNs (most PGNs are single-packet, containing 8 bytes of data).

For each additional ECU with approximately 10 configured (single frame) Parameter Group Numbers (PGNs):

- the application size increases by an average of 15 Kbytes. This figure includes the memory consumed by implicitly-generated variables for configured Suspected Parameter Numbers (SPNs). This application size increase could result in exceeding memory limits.
- the number of input bits (%I) used on the logic controller increases in proportion to the number and size of PGNs configured as "TX Signals" in a non-local ECU or "RX Signals" in a local ECU.
- the number of output bits (%Q) used on the logic controller increases in proportion to the number and size of PGNs configured as "TX Signals" in a local ECU.

NOTE: Thoroughly test your application regarding the number of configured J1939 ECUs connected to the controller, and the number of PGNs configured on each ECU, to avoid a system overload watchdog condition or performance degradation.

For more information, refer to J1939 Interface Configuration (see Modicon M251 Logic Controller, Programming Guide).

CAN Wiring Diagram

The CAN plug is a male sub-D9 terminal block:

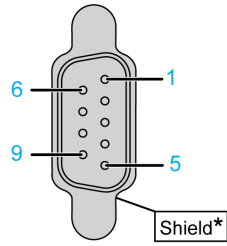

* To be connected externally to the protective earth

Pin	Signal	Description
1	–	Reserved
2	CAN_L	CAN_L bus line
3	CAN_GND	CAN ground
4	–	Reserved
5	(CAN_SHLD)	Optional CAN shield
6	GND	Ground
7	CAN_H	CAN_H bus line
8	–	Reserved
9	(CAN_V+)	Optional CAN external positive supply

⚠ WARNING

UNINTENDED EQUIPMENT OPERATION

Do not connect wires to unused terminals and/or terminals indicated as “No Connection (N.C.)”.

Failure to follow these instructions can result in death, serious injury, or equipment damage.

Transmission Speed and Cable Length

Transmission speed is limited by the bus length and the type of cable used.

The following table describes the relationship between the maximum transmission speed and the bus length (on a single CAN segment without a repeater):

Maximum transmission baud rate	Bus length
1000 kbps	20 m (65 ft)
800 kbps	40 m (131 ft)
500 kbps	100 m (328 ft)
250 kbps	250 m (820 ft)
125 kbps	500 m (1,640 ft)
50 kbps	1000 m (3280 ft)
20 kbps	2500 m (16,400 ft)

NOTE: The CAN cable must be shielded.

Ethernet Port

Overview

The M251 Logic Controller is equipped with Ethernet communications ports:

Reference	Number of Ports	Port Name
TM251MESC	2 (one dual Ethernet port switch)	Ethernet 1
TM251MESE	2 (one dual Ethernet port switch)	Ethernet 1
	1	Ethernet 2

Characteristics

This table describes the different Ethernet characteristics:

Characteristic	Description
Function	Modbus TCP/IP, Machine Expert protocol, EtherNet I/P
Connector type	RJ45
Auto negotiation	From 10 Mbps half duplex to 100 Mbps full duplex
Cable type	Shielded
Automatic cross-over detection	Yes

Pin Assignment

This figure shows the RJ45 Ethernet connector pin assignment:

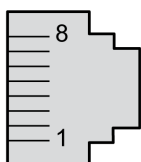

This table describes the RJ45 Ethernet connector pins:

Pin N°	Signal
1	TD+
2	TD-
3	RD+
4	-
5	-
6	RD-
7	-
8	-

NOTE: The controller supports the MDI/MDIX auto-crossover cable function. It is not necessary to use special Ethernet crossover cables to connect devices directly to this port (connections without an Ethernet hub or switch).

NOTE: Ethernet cable disconnection is detected every second. In case of disconnection of a short duration (< 1 second), the network status may not indicate the disconnection.

Status LEDs

These figures show the RJ45 connectors status LEDs:

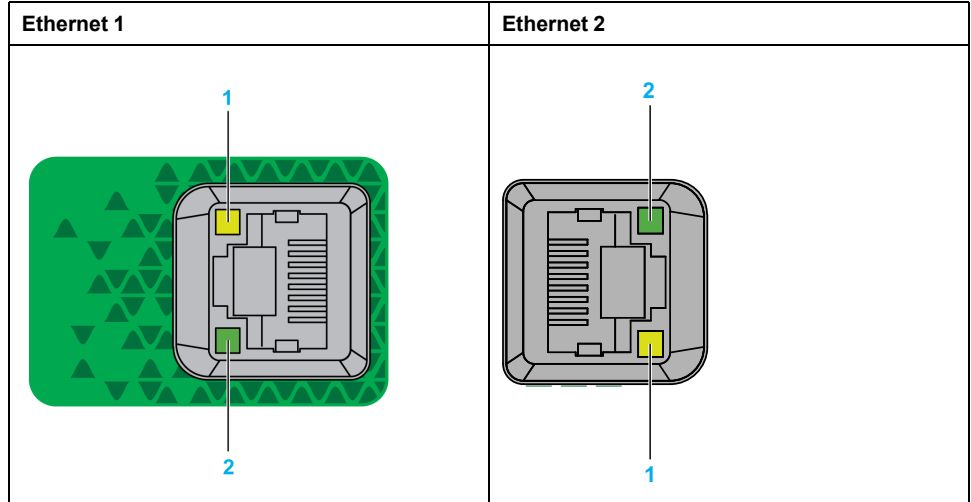

This table describes the Ethernet status LEDs:

Label	Description	LED		
		Color	Status	Description
1	Ethernet link/speed	Green/ Yellow	Off	No link
			Solid yellow	Link at 10 Mbps
			Solid green	Link at 100 Mbps
2	Ethernet activity	Green	Off	No activity and no link
			On	The link is detected, but there is no activity
			Flashing	Transmitting or receiving data

TM251MESE Specific Considerations

Ethernet Ports

The TM251MESE has two different Ethernet networks. Each has its own unique IP and MAC addresses.

The two Ethernet networks are called Ethernet 1 and Ethernet 2:

- Ethernet 1 is made of two switched Ethernet ports dedicated to communication between machines or with the control network.
- Ethernet 2 is made of one Ethernet port dedicated to the device network and supporting industrial Ethernet connections.

Industrial Ethernet Architecture

This figure presents a typical industrial Ethernet architecture:

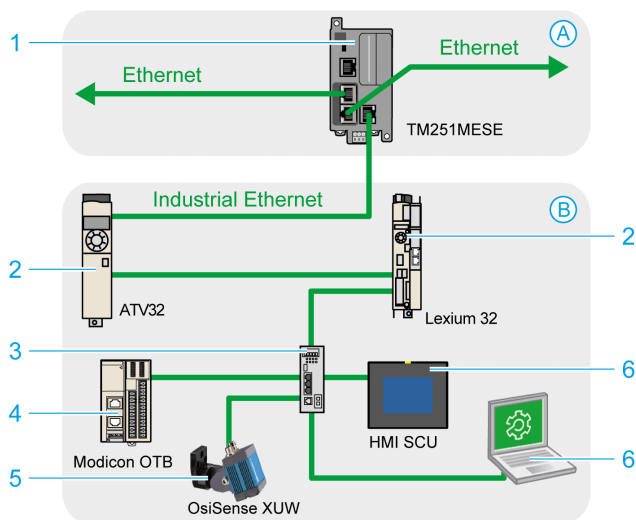

A	Control network
B	Device network
1	Logic controller (see EcoStruxure Machine Expert Industrial Ethernet, User Guide)
2	Daisy-chained slaves
3	Ethernet switch
4	I/O island (Modbus TCP)
5	Vision sensor (EtherNet/IP)
6	PC and HMI (TCP/UDP)
2, 4, and 5	Industrial Ethernet slave devices (EtherNet/IP / Modbus TCP)

Industrial Ethernet Connections with Modbus TCP IOScanner Architecture

For example, you can:

- Connect your PC to Ethernet 1.
- Use a Modbus TCP IOScanner or EtherNet/IP Scanner with the Ethernet 2.

This figure is an example of an industrial Ethernet architecture with the TM251MESE.

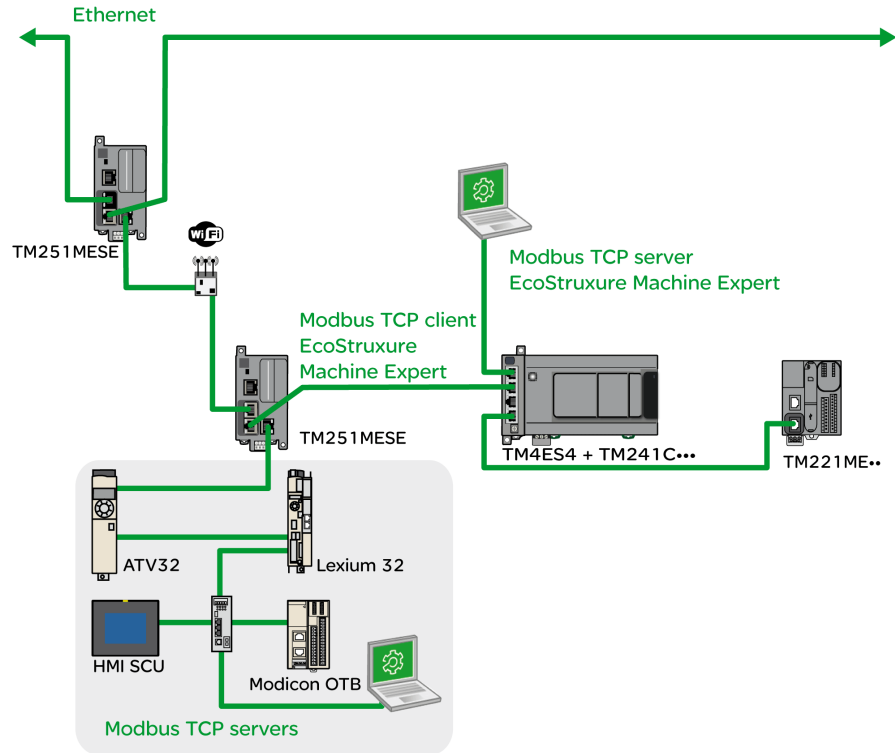

USB Mini-B Programming Port

Overview

The USB Mini-B Port is the programming port you can use to connect a PC with a USB host port using EcoStruxure Machine Expert software. Using a typical USB cable, this connection is suitable for quick updates of the program or short duration connections to perform maintenance and inspect data values. It is not suitable for long-term connections such as commissioning or monitoring without the use of specially adapted cables to help minimize electromagnetic interference.

⚠ WARNING

UNINTENDED EQUIPMENT OPERATION OR INOPERABLE EQUIPMENT

- You must use a shielded USB cable such as a BMX XCAUSBH0.. secured to the functional ground (FE) of the system for any long-term connection.
- Do not connect more than one controller or bus coupler at a time using USB connections.
- Do not use the USB port(s), if so equipped, unless the location is known to be non-hazardous.

Failure to follow these instructions can result in death, serious injury, or equipment damage.

Characteristics

This table describes the characteristics of the USB Mini-B programming port:

Parameter	USB Programming Port
Function	Compatible with USB 2.0
Connector type	Mini-B
Isolation	None
Cable type	Shielded

Serial Line

Overview

The serial line:

- Can be used to communicate with devices supporting the Modbus protocol as either master or slave, ASCII protocol (printer, modem...) and Machine Expert Protocol (HMI,...).
- provides a 5 Vdc power distribution.

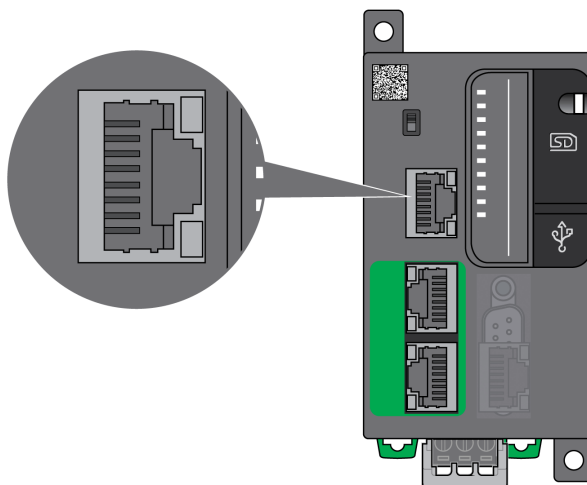

Characteristics

Characteristic		Description
Function		RS485 or RS232 software configured
Connector type		RJ45
Isolation		Non-isolated
Maximum baud rate		1200 up to 115 200 bps
Cable	Type	Shielded
	Maximum length (between the controller and an isolated junction box)	15 m (49 ft) for RS485 3 m (9.84 ft) for RS232
Polarization		Software configuration is used to connect when the node is configured as a master. 560 Ω resistors are optional.
5 Vdc power supply for RS485		Yes

NOTE: Some devices provide voltage on RS485 serial connections. Do not connect these voltage lines to your controller as they may damage the controller serial port electronics and render the serial port inoperable.

NOTICE
<p>INOPERABLE EQUIPMENT</p> <p>Use only the VW3A8306R•• serial cable to connect RS485 devices to your controller.</p> <p>Failure to follow these instructions can result in equipment damage.</p>

Pin Assignment

The following figure shows the pins of the RJ45 connector:

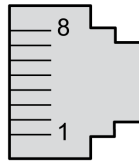

This table describes the pin assignment of the RJ45 connector:

Pin	RS232	RS485
1	RxD	N.C.
2	TxD	N.C.
3	N.C.	N.C.
4	N.C.	D1
5	N.C.	D0
6	N.C.	N.C.
7	N.C. *	5 Vdc
8	Common	Common

*: 5 Vdc delivered by the controller, do not connect.

N.C.: No connection

RxD: Received data

TxD: Transmitted data

▲ WARNING
<p>UNINTENDED EQUIPMENT OPERATION</p> <p>Do not connect wires to unused terminals and/or terminals indicated as “No Connection (N.C.)”.</p> <p>Failure to follow these instructions can result in death, serious injury, or equipment damage.</p>

Status LED

This table describes the serial line status LED:

Label	Description	LED		
		Color	Status	Description
SL	Serial line	Green	Flashing	Indicates the activity of the serial line.
			Off	Indicates no serial communication.

Connecting the M251 Logic Controller to a PC

What's in This Chapter

Connecting the Controller to a PC..... 79

Connecting the Controller to a PC

Overview

To transfer, run, and monitor the applications, connect the controller to a computer, that has EcoStruxure Machine Expert installed, using either a USB cable or an Ethernet connection (for those references that support an Ethernet port).

NOTICE
INOPERABLE EQUIPMENT
Always connect the communication cable to the PC before connecting it to the controller.
Failure to follow these instructions can result in equipment damage.

USB Powered Download

In order to execute limited operations, the M251 Logic Controller has the capability to be powered through the USB Mini-B port. A diode mechanism avoids having the logic controller both powered by USB and by the normal power supply, or to supply voltage on the USB port.

When powered only by USB, the logic controller executes the firmware and the boot project (if any) and the I/O board is not powered during boot (same duration as a normal boot). USB powered download initializes the internal flash memory with some firmware or some application and parameters when the controller is powered by USB. The preferred tool to connect to the controller is the **Controller Assistant**. Refer to the *EcoStruxure Machine Expert Controller Assistant User Guide*.

The controller packaging allows easy access to USB Mini-B port with minimum opening of the packaging. You can connect the controller to the PC with a USB cable. Long cables are not suitable for the USB powered download.

⚠ WARNING
INSUFFICIENT POWER FOR USB DOWNLOAD
Do not use a USB cable longer than 3m (9.8 ft) for USB powered download.
Failure to follow these instructions can result in death, serious injury, or equipment damage.

NOTE: It is not intended that you use the USB Powered Download on an installed controller. Depending on the number of I/O expansion modules in the physical configuration of the installed controller, there may be insufficient power from your PC USB port to accomplish the download.

USB Mini-B Port Connection

Cable Reference	Details
BMXXCAUSBH018:	Grounded and shielded, this USB cable is suitable for long duration connections.
TCSXCNAMUM3P:	This USB cable is suitable for short duration connections such as quick updates or retrieving data values.

NOTE: You can only connect 1 controller or any other device associated with EcoStruxure Machine Expert and its component to the PC at any one time.

The USB Mini-B Port is the programming port you can use to connect a PC with a USB host port using EcoStruxure Machine Expert software. Using a typical USB cable, this connection is suitable for quick updates of the program or short duration connections to perform maintenance and inspect data values. It is not suitable for long-term connections such as commissioning or monitoring without the use of specially adapted cables to help minimize electromagnetic interference.

⚠ WARNING

UNINTENDED EQUIPMENT OPERATION OR INOPERABLE EQUIPMENT

- You must use a shielded USB cable such as a BMX XCAUSBH0•• secured to the functional ground (FE) of the system for any long-term connection.
- Do not connect more than one controller or bus coupler at a time using USB connections.
- Do not use the USB port(s), if so equipped, unless the location is known to be non-hazardous.

Failure to follow these instructions can result in death, serious injury, or equipment damage.

The communication cable should be connected to the PC first to minimize the possibility of electrostatic discharge affecting the controller.

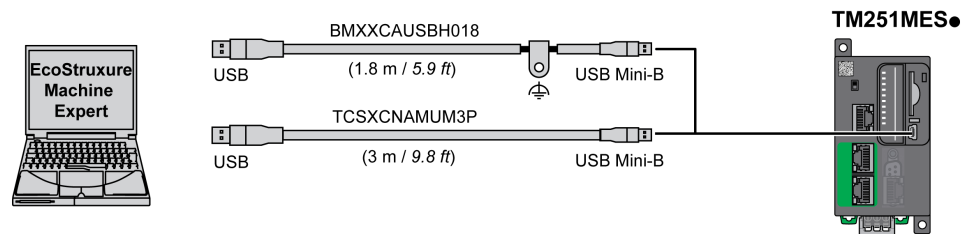

To connect the USB cable to your controller, follow the steps below:

Step	Action
1	<p>1a If making a long-term connection using the cable BMXXCAUSBH018, or other cable with a ground shield connection, be sure to securely connect the shield connector to the functional ground (FE) or protective ground (PE) of your system before connecting the cable to your controller and your PC.</p> <p>1b If making a short-term connection using the cable TCSXCNAMUM3P or other non-grounded USB cable, proceed to step 2.</p>
2	Connect your USB cable to the computer.
3	Open the protective cover for the USB mini-B slot on the controller.
4	Connect the mini-B connector of your USB cable to the controller.

Ethernet Port Connection

You can also connect the controller to a PC using an Ethernet cable.

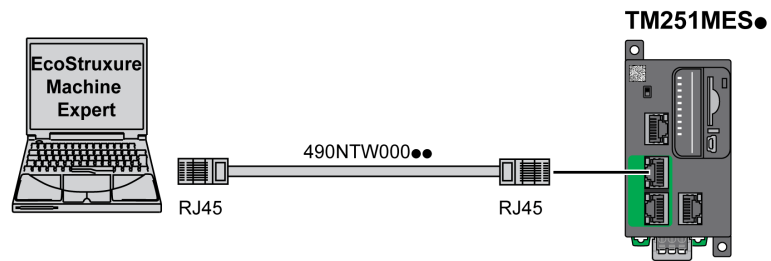

To connect the controller to the PC, do the following:

Step	Action
1	Connect the Ethernet cable to the PC.
2	Connect the Ethernet cable to any of the Ethernet ports on the controller.

Glossary

A

application:

A program including configuration data, symbols, and documentation.

ASCII:

(American standard code for Information Interchange) A protocol for representing alphanumeric characters (letters, numbers, certain graphics, and control characters).

B

bps:

(bit per second) A definition of transmission rate, also given in conjunction with multiplier kilo (kbps) and mega (mbps).

C

CANopen:

An open industry-standard communication protocol and device profile specification (EN 50325-4).

CFC:

(continuous function chart) A graphical programming language (an extension of the IEC 61131-3 standard) based on the function block diagram language that works like a flowchart. However, no networks are used and free positioning of graphic elements is possible, which allows feedback loops. For each block, the inputs are on the left and the outputs on the right. You can link the block outputs to the inputs of other blocks to create complex expressions.

configuration:

The arrangement and interconnection of hardware components within a system and the hardware and software parameters that determine the operating characteristics of the system.

continuous function chart language:

A graphical programming language (an extension of the IEC61131-3 standard) based on the function block diagram language that works like a flowchart. However, no networks are used and free positioning of graphic elements is possible, which allows feedback loops. For each block, the inputs are on the left and the outputs on the right. You can link the block outputs to inputs of other blocks to create complex expressions.

controller:

Automates industrial processes (also known as programmable logic controller or programmable controller).

D

DIN:

(Deutsches Institut für Normung) A German institution that sets engineering and dimensional standards.

E

EIA rack:

(electronic industries alliance rack) A standardized (EIA 310-D, IEC 60297, and DIN 41494 SC48D) system for mounting various electronic modules in a stack or rack that is 19 inches (482.6 mm) wide.

EN:

EN identifies one of many European standards maintained by CEN (*European Committee for Standardization*), CENELEC (*European Committee for Electrotechnical Standardization*), or ETSI (*European Telecommunications Standards Institute*).

F

FBD:

(function block diagram) One of 5 languages for logic or control supported by the standard IEC 61131-3 for control systems. Function block diagram is a graphically oriented programming language. It works with a list of networks, where each network contains a graphical structure of boxes and connection lines, which represents either a logical or arithmetic expression, the call of a function block, a jump, or a return instruction.

FE:

(functional Earth) A common grounding connection to enhance or otherwise allow normal operation of electrically sensitive equipment (also referred to as functional ground in North America).

In contrast to a protective Earth (protective ground), a functional earth connection serves a purpose other than shock protection, and may normally carry current. Examples of devices that use functional earth connections include surge suppressors and electromagnetic interference filters, certain antennas, and measurement instruments.

H

HE10:

Rectangular connector for electrical signals with frequencies below 3 MHz, complying with IEC 60807-2.

I

I/O:

(input/output)

IEC 61131-3:

Part 3 of a 3-part IEC standard for industrial automation equipment. IEC 61131-3 is concerned with controller programming languages and defines 2 graphical and 2 textual programming language standards. The graphical programming languages are ladder diagram and function block diagram. The textual programming languages include structured text and instruction list.

IEC:

(international electrotechnical commission) A non-profit and non-governmental international standards organization that prepares and publishes international standards for electrical, electronic, and related technologies.

IL:

(instruction list) A program written in the language that is composed of a series of text-based instructions executed sequentially by the controller. Each instruction includes a line number, an instruction code, and an operand (refer to IEC 61131-3).

instruction list language:

A program written in the instruction list language that is composed of a series of text-based instructions executed sequentially by the controller. Each instruction includes a line number, an instruction code, and an operand (see IEC 61131-3).

IP 20:

(ingress protection) The protection classification according to IEC 60529 offered by an enclosure, shown by the letter IP and 2 digits. The first digit indicates 2 factors: helping protect persons and for equipment. The second digit indicates helping protect against water. IP 20 devices help protect against electric contact of objects larger than 12.5 mm, but not against water.

L**ladder diagram language:**

A graphical representation of the instructions of a controller program with symbols for contacts, coils, and blocks in a series of rungs executed sequentially by a controller (see IEC 61131-3).

LD:

(ladder diagram) A graphical representation of the instructions of a controller program with symbols for contacts, coils, and blocks in a series of rungs executed sequentially by a controller (refer to IEC 61131-3).

M**master/slave:**

The single direction of control in a network that implements the master/slave mode.

Modbus:

The protocol that allows communications between many devices connected to the same network.

N**NEMA:**

(national electrical manufacturers association) The standard for the performance of various classes of electrical enclosures. The NEMA standards cover corrosion resistance, ability to help protect from rain, submersion, and so on. For IEC member countries, the IEC 60529 standard classifies the ingress protection rating for enclosures.

P**PDO:**

(process data object) An unconfirmed broadcast message or sent from a producer device to a consumer device in a CAN-based network. The transmit PDO from the producer device has a specific identifier that corresponds to the receive PDO of the consumer devices.

PE:

(Protective Earth) A common grounding connection to help avoid the hazard of electric shock by keeping any exposed conductive surface of a device at earth potential. To avoid possible voltage drop, no current is allowed to flow in this conductor (also referred to as *protective ground* in North America or as an equipment grounding conductor in the US national electrical code).

program:

The component of an application that consists of compiled source code capable of being installed in the memory of a logic controller.

R**RJ45:**

A standard type of 8-pin connector for network cables defined for Ethernet.

RPDO:

(receive process data object) An unconfirmed broadcast message or sent from a producer device to a consumer device in a CAN-based network. The transmit PDO from the producer device has a specific identifier that corresponds to the receive PDO of the consumer devices.

RS-485:

A standard type of serial communication bus, based on 2 wires (also known as EIA RS-485).

RxD:

The line that receives data from one source to another.

S**SFC:**

(sequential function chart) A language that is composed of steps with associated actions, transitions with associated logic condition, and directed links between steps and transitions. (The SFC standard is defined in IEC 848. It is IEC 61131-3 compliant.)

ST:

(structured text) A language that includes complex statements and nested instructions (such as iteration loops, conditional executions, or functions). ST is compliant with IEC 61131-3.

T**terminal block:**

(terminal block) The component that mounts in an electronic module and provides electrical connections between the controller and the field devices.

TPDO:

(transmit process data object) An unconfirmed broadcast message or sent from a producer device to a consumer device in a CAN-based network. The transmit PDO from the producer device has a specific identifier that corresponds to the receive PDO of the consumer devices.

TxD:

The line that sends data from one source to another.

Index

A

accessories 34

B

bus coupler
specifications 31

C

CANopen communication 69
certifications and standards 44
communication
CANopen 69
Communication Ports 69
Ethernet Port 72
Serial Line 1 76
USB Programming Port 75
connections
to CANopen slaves 69
to J1939 ECUs 70

E

ECUs, max. number of J1939 70
Electrical Requirements
Installation 54
Electromagnetic Susceptibility 44
Environmental Characteristics 42

F

features
key features 14
fieldbus interface
specifications 32

G

Grounding 59

I

installation
logic/motion controller installation 45
Installation 42
Electrical Requirements 54
intended use 6

J

J1939
capabilities 70

L

logic/motion controller installation 45

M

M251
TM251MESC 62
TM251MESE 65
mounting positions 46

P

PGNs, max. number of J1939 70
Power Supply 56
presentation
TM251MESC 62
TM251MESE 65
programming languages
IL, LD, grafcet 14

Q

qualification of personnel 5

R

real time clock 35
Run/Stop 38

S

SD Card 39
Serial Line 1
Communication Ports 76

U

USB Programming Port
Communication Ports 75

W

wiring 54

Schneider Electric
35 rue Joseph Monier
92500 Rueil Malmaison
France

+ 33 (0) 1 41 29 70 00

www.se.com

As standards, specifications, and design change from time to time,
please ask for confirmation of the information given in this publication.

© 2022 Schneider Electric. All rights reserved.

EIO0000003101.04