



Main

Range of Product	Harmony Timer Relays
Product or Component Type	Multifunction relay
Discrete output type	Relay
Width	0.69 in (17.5 mm)
Device short name	RE17R
Time delay type	Pulse delay Safe-guard Bistable Interval
Time delay range	6...60 s 1...10 min 0.1...1 s 1...10 h 1...10 s 6...60 min 10...100 h
Nominal output current	8 A

Complementary

Contacts type and composition	1 C/O
Contacts material	Cadmium free
Height	3.54 in (90 mm)
Depth	2.83 in (72 mm)
Control type	Selector switch front panel
[Us] rated supply voltage	24...240 V AC 50/60 Hz 24 V DC
Voltage range	0.85...1.1 Us
Supply frequency	50...60 Hz +/- 5 %
Release of input voltage	10 V
Connections - terminals	Spring terminals, 2 x 0.2...2 x 1.5 mm ² AWG 24...AWG 16) solid without cable end Spring terminals, 2 x 0.2...2 x 1.5 mm ² AWG 24...AWG 16) flexible without cable end
Housing material	Self-extinguishing
Repeat accuracy	+/- 0.5 % IEC 61812-1
Temperature drift	+/- 0.05 %/°C
Voltage drift	+/- 0.2 %/V
Setting accuracy of time delay	+/- 10 % of full scale 25 °C IEC 61812-1
Control signal pulse width	100 ms with load in parallel typical 30 ms typical
Insulation resistance	100 MOhm 500 V DC IEC 60664-1
Reset time	120 ms on de-energisation typical
On-load factor	100 %
Power consumption in VA	0...32 VA 240 V AC
Maximum power consumption in W	0.6 W 24 V DC
Minimum switching current	10 mA 5 V DC
Maximum switching current	8 A AC/DC
Maximum switching voltage	250 V AC
Breaking capacity	2000 VA

Operating frequency	10 Hz
Electrical durability	100000 cycles resistive 8 A 250 V AC
Mechanical durability	10000000 cycles
Dielectric strength	2.5 kV 1 mA/1 minute 50 Hz IEC 61812-1
[Uimp] rated impulse withstand voltage	5 kV 1.2/50 µs
Power on delay	100 ms
Marking	CE
Creepage distance	4 kV/3 IEC 60664-1
Safety reliability data	MTTFd = 296.8 years B10d = 270000
Mounting position	Any position in relation to normal vertical mounting plane
Mounting support	35 mm DIN rail conforming to EN/IEC 60715
Local signalling	LED indicator on steady: relay energised, no timing in progress LED indicator 80 % ON and 20 % OFF flashing: timing in progress LED indicator 5 % ON and 95 % OFF pulsing: relay de-energised, no timing in progress (except function Di-D, Li-L)
Net Weight	0.13 lb(US) (0.06 kg)
Time delay type	Ad, Ah, N, O, P, Pt, Tl, Tt, W
Functionality	Multifunction
Compatibility code	RE17

Environment

Immunity to microbreaks	20 ms
Standards	2006/95/EC 2004/108/EC EN 61000-6-1 EN 61000-6-4 EN 61000-6-2 EN 61000-6-3 IEC 61812-1
Product Certifications	CSA CULus DNV-GL EAC CCC
Ambient Air Temperature for Storage	-22...140 °F (-30...60 °C)
Ambient Air Temperature for Operation	-4...140 °F (-20...60 °C)
IP degree of protection	IP20 IEC 60529 terminal block) IP40 IEC 60529 housing) IP50 IEC 60529 front panel)
Vibration resistance	20 m/s ² 10...150 Hz)IEC 60068-2-6
Shock resistance	15 gn 11 ms IEC 60068-2-27
Relative Humidity	93 % without condensation IEC 60068-2-30
Electromagnetic compatibility	Electrostatic discharge immunity test 6 kV in contact) level 3 IEC 61000-4-2 Electrostatic discharge immunity test 8 kV in air) level 3 IEC 61000-4-2 Susceptibility to electromagnetic fields 10 V/m 80 MHz to 1 GHz) level 3 IEC 61000-4-3 Electrical fast transient/burst immunity test 1 kV capacitive connecting clip) level 3 IEC 61000-4-4 Electrical fast transient/burst immunity test 2 kV direct) level 3 IEC 61000-4-4 1.2/50 µs shock waves immunity test 1 kV differential mode) level 3 IEC 61000-4-5 1.2/50 µs shock waves immunity test 2 kV common mode) level 3 IEC 61000-4-5 Conducted RF disturbances 10 V 0.15...80 MHz) level 3 IEC 61000-4-6 Voltage dips and interruptions immunity test 0 % 1 cycle) IEC 61000-4-11 Voltage dips and interruptions immunity test 70 % 25/30 cycles) IEC 61000-4-11 Conducted and radiated emissionsclass B EN 55022

Ordering and shipping details

Category	22370-RE, RM MISC TIMERS & COUNTERS
Discount Schedule	CP2
GTIN	3606489861667
Returnability	No

Packing Units

Unit Type of Package 1	PCE
Number of Units in Package 1	1
Package 1 Height	1.10 in (2.8 cm)
Package 1 Width	2.95 in (7.5 cm)
Package 1 Length	3.74 in (9.5 cm)
Package 1 Weight	2.47 oz (70 g)
Unit Type of Package 2	S02
Number of Units in Package 2	40
Package 2 Height	5.91 in (15 cm)
Package 2 Width	11.81 in (30 cm)
Package 2 Length	15.75 in (40 cm)
Package 2 Weight	7.52 lb(US) (3.411 kg)

Offer Sustainability

Sustainable offer status	Green Premium product
California proposition 65	WARNING: This product can expose you to chemicals including: Lead and lead compounds, which is known to the State of California to cause cancer and birth defects or other reproductive harm. For more information go to www.P65Warnings.ca.gov
REACH Regulation	REACH Declaration
EU RoHS Directive	Pro-active compliance (Product out of EU RoHS legal scope) EU RoHS Declaration
Mercury free	Yes
China RoHS Regulation	China RoHS Declaration
RoHS exemption information	Yes
Environmental Disclosure	Product Environmental Profile
Circularity Profile	End Of Life Information
WEEE	The product must be disposed on European Union markets following specific waste collection and never end up in rubbish bins.

Dimensions

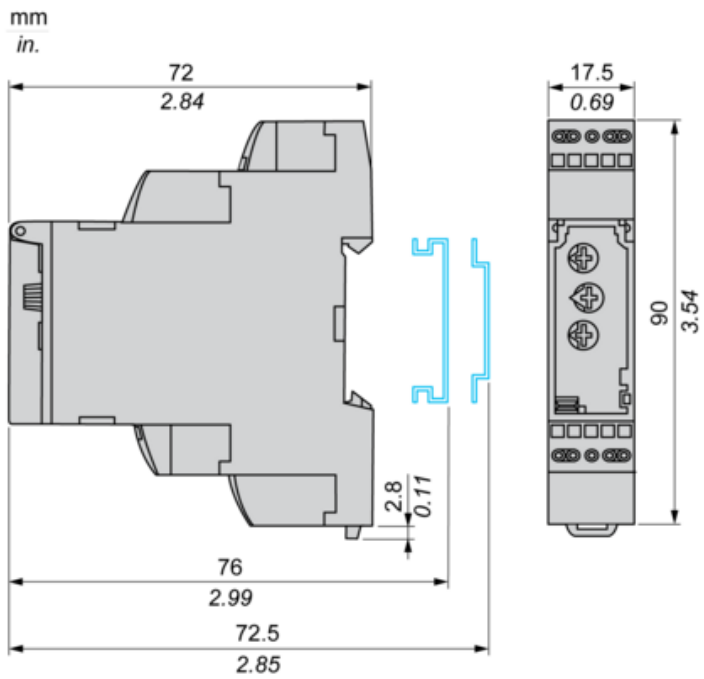

Internal Wiring Diagram

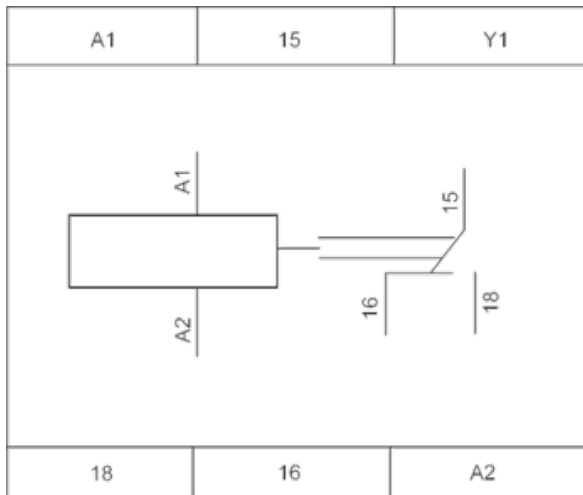

Wiring Diagram

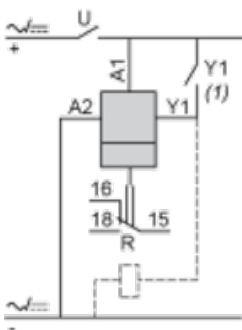

1) Contact Y1:

- Control for functions B, C, Ac, Bw, Ad, Ah, N, O, W, T, Tt.
- Partial stop for functions At, Ht and Pt.
- Function D if Di selected.
- Not used for functions A, H and P.

Function Ad : Pulse Delayed Relay with Control Signal

Description

After power-up, pulsing or maintaining of control contact C starts the timing T.
 At the end of this timing period T, the output R closes.
 The output R will be reset the next time control contact C is pulsed or maintained.

Function: 1 Output

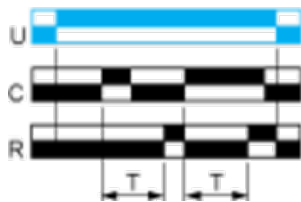

Function Ah : Pulse Delayed Relay (Single Cycle) with Control Signal

Description

After power-up, pulsing or maintaining of control contact C starts the timing T. A single cycle then starts with 2 timing periods T of equal duration (start with output in rest position).
 Output R closes at the end of the first timing period T and reverts to its initial position at the end of the second timing period T.
 Control contact C must be reset in order to re-start the single flashing cycle.

Function: 1 Output



Function N : Retriggerable Interval Relay with Control Signal On

Description

After power-up and an initial control pulse C, the output R closes.
 If the interval between two control pulses C is greater than the set timing period T, timing elapses normally and the output R closes at the end of the timing period. If the interval is not greater than the set timing period, the output R remains closed until this condition is met.

Function: 1 Output



Function O : Retriggerable Interval Delayed Relay with Control Signal On

Description

An initial timing period T begins on energisation. At the end of this timing period, the output R closes.

As soon as there is a control pulse C, the output R reverts to its initial state until the interval between two control pulses is less than the value of the set timing period T. Otherwise, the output R closes at the end of the timing period T.

Function: 1 Output

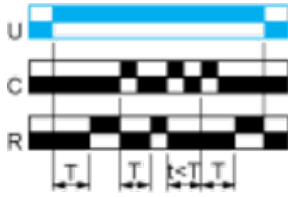

Function P : Pulse Delayed Relay with Fixed Pulse Length

Description

The timing period T begins on energisation.
At the end of this period, the output R closes for a fixed time P.

Function: 1 Output



P = 500 ms

Function Pt : Pulse Delayed Relay (Summation and Fixed Pulse Length) with Control Signal Off

Description

On energisation, timing period T starts (it can be interrupted by operating the Gate control contact G).
At the end of this period, the output R closes for a fixed time P.

Function: 1 Output

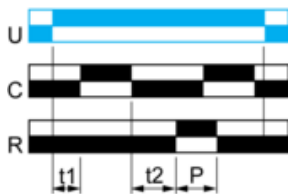

$T = t_1 + t_2 + \dots$

P = 500 ms

Function TL : Bistable Relay with Control Signal On

Description

After power-up, pulsing or maintaining of control contact Y1 switches the output on.
A second pulse on the control contact Y1 switches the output relay off.

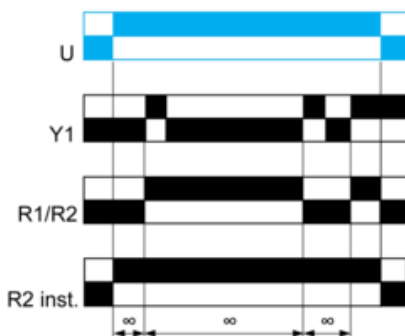

Function Tt : Retriggerable Bistable Relay with Control Signal On

Description

After power-up, pulsing or maintaining of control contact C switches output R on and starts timing T.
The output switches off at the end of the timing period T or following a second pulse on the control contact C.

Function: 1 Output

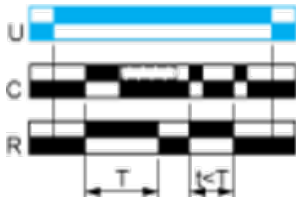

Function W : Interval Relay with Control Signal Off

Description

After power-up and opening of the control contact, the output(s) close(s) for a timing period T.
At the end of this timing period the output(s) revert(s) to its/their initial state.
The second output can be either timed or instantaneous.

Function: 1 Output



Function: 2 Outputs

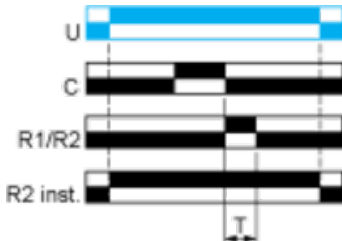

2 timed outputs (R1/R2) or 1 timed output (R1) and 1 instantaneous output (R2 inst.).

Legend

Relay de-energised

Relay energised

Output open

Output closed

C	Control contact
G	Gate
R	Relay or solid state output
R1/R2	2 timed outputs
R2 inst.	The second output is instantaneous if the right position is selected
T	Timing period
Ta -	Adjustable On-delay
Tr -	Adjustable Off-delay
U	Supply