



Modicon MC80

Programmable logic controllers

Quick access to product information

Get technical information about your product

References

Modicon TM3
I/O expansion modules for Modicon controllers
Analog I/O modules

Number and type of channels	Input range	Output range	Resolution	Input terminal (Modicon)	Reference	Weight
2 enhancement inputs	-10...+10 VDC 0...20 mA, 4...20 mA	10 mA or 10 mA + sign	12 bits or 12 bits + sign	Terminal 2 Terminal 3	TM3AI2H TM3AI2H	0,110 0,230
4 enhancement inputs	-10...+10 VDC 0...20 mA, 4...20 mA	10 mA or 10 mA + sign	12 bits or 12 bits + sign	Terminal 2 Terminal 3	TM3AI4H TM3AI4H	0,150 0,240
4 enhancement or temperature inputs	-10...+10 VDC 0...20 mA, 4...20 mA PT100, RTD, Ni100, Ni200, Ni500, Ni1000 -1...+10 VDC 0...20 mA, 4...20 mA	10 mA or 10 mA + sign	12 bits or 12 bits + sign	Terminal 2 Terminal 3	TM3AI4T TM3AI4T	0,150 0,240
4 differential temperature inputs	Thermocouples (K, J, N, S, T, E, C) Non-thermocouples -1...+10 VDC 0...20 mA, 4...20 mA	10 mA or 10 mA + sign	12 bits or 12 bits + sign	Terminal 2 Terminal 3	TM3AI4D TM3AI4D	0,150 0,240
2 enhancement inputs	-10...+10 VDC	10 mA or 10 mA + sign	12 bits or 12 bits + sign	Terminal 2 Terminal 3	TM3AI2H TM3AI2H	0,110 0,230

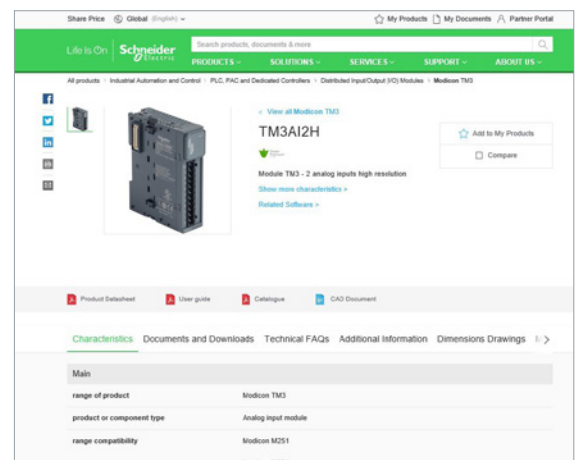

Each commercial reference presented in a catalog contains a hyperlink. Click on it to obtain the technical information of the product:

- Characteristics, Dimensions and drawings, Mounting and clearance, Connections and schemas, Performance curves
- Product image, Instruction sheet, User guide, Product certifications, End of life manual

Find your catalog

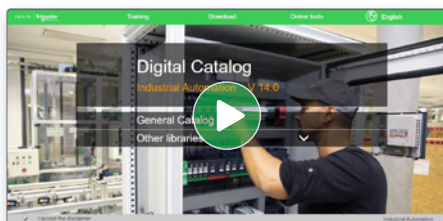

- > With just 3 clicks, you can access the Industrial Automation and Control catalogs, in both English and French
- > Consult digital automation catalogs at [Digi-Cat Online](#)

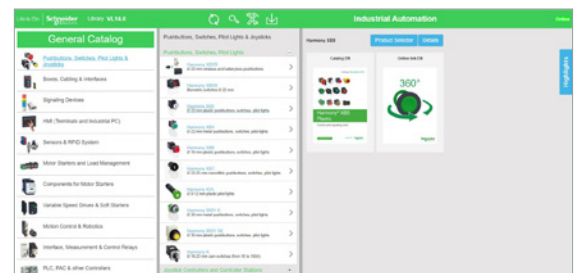

- Up-to-date catalogs
- Embedded product selectors, 360° pictures
- Optimized search by commercial references

Select your training



- > Find the right [Training](#) for your needs on our Global website
- > Locate the training center with the selector tool, using this [link](#)

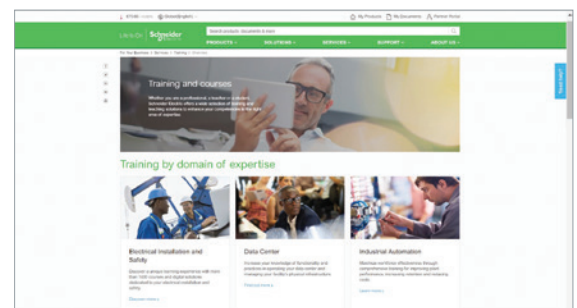



Modicon

Discover Modicon

Industrial Edge control for IIoT

Modicon IIoT-native edge controllers manage complex interfaces across assets and devices or directly into the cloud, with embedded safety and cybersecurity. Modicon provides performance and scalability for a wide range of industrial applications up to high-performance multi-axis machines and high-available redundant processes.

Explore our offer

- Modicon HVAC Controllers
- Modicon PLC
- Modicon Motion Controllers
- Modicon PAC
- Modicon I/O
- Modicon Networking
- Modicon Power Supply
- Modicon Wiring
- Modicon Safety

Life Is On



General contents

Modicon MC80 programmable logic controllers

■ General presentation.....	page 2
<i>Selection guide</i>	page 4
■ Presentation.....	page 6
■ Description.....	page 7
■ Communication	page 8
■ Architectures	page 8
■ References	page 9
■ Standards and certifications	page 12
■ Environment tests	page 13
■ Automation product certifications and EC regulations	page 16
■ Product reference index.....	page 18

Modicon MC80 programmable logic controllers

Robustness and reliability, “all-in-one” controller, versatility and scalability

Modicon MC80 The compact PLC

The MC80 is a compact PLC (Programmable Logic Controller) with cost-effective TCO (Total Cost of Ownership).

It provides optimized operation, withstanding extreme conditions with high reliability and performance. It also includes special features to simplify diagnostics and automate maintenance tasks in order to reduce downtime.



Robustness and reliability

Robustly built for extreme operation

- > Fit for purpose as a local controller
- > Built to withstand extreme temperatures (- 25°C to + 70°C/- 13°F to + 158°F) to increase system availability
- > Scalability, high availability, cybersecurity and data exchanges native to MC80, easy to adapt to the plant specific's characteristics
- > Completely integrated with the other Modicon controllers, programmed and commissioned with EcoStruxure Control Expert

“All-in-one” controller

Compact controller with

- > A high-performance processor **1** with 64-bit calculation capability
- > Dual Ethernet port with embedded switch to create flexible and scalable architectures without external switches **2**
- > Integrated I/Os to interface with hard-wired devices and sensors **3**
- > A Modbus Serial link master/slave port for easy integration of local instrumentation or a portable HMI **4**
- > A CANopen master port for easy connection of devices such as encoders or variable speed drives **5**



Processor

+
communication
+
I/O
=
“All-in-one”
controller

Versatility and scalability

Flexibility in design

- > Fully distributed, scalable architecture based on an open standard that accommodates diverse topologies
- > Fully integrated in Schneider Automation Platform, including EcoStruxure Control Expert configuration software
- > Excellent ability to integrate external devices such as encoders and variable speed drives via I/O cards or communication ports
- > Scalable and open architectures for thousands of devices



Ethernet Modbus
TCP

+ Reduced installation time thanks to a compact “all-in-one” PLC



Cybersecurity

Cybersecurity ready

- > Access to the PLC is password-protected. Additionally, only selected devices are allowed to connect to Modicon MC80 controllers
- > Firmware upgrading is password-protected
- > Memory protection mode is available via physical inputs or software configuration. The applications and user data are protected in this mode
- > Run/Stop protection mode is available via physical inputs or software configuration

Outstanding durability and integrated cybersecurity



High network availability

Operational intelligence thanks to

- > Full Ethernet architectures with access to data from anywhere: immediate insight into the process
- > Native support of RSTP (Rapid Spanning Tree Protocol) ring topology for network redundancy in the event of link failure

Extend your process or application easily with flexible Modicon MC80 architectures or with Ethernet transparency

Real-time data access from any location enables timely action

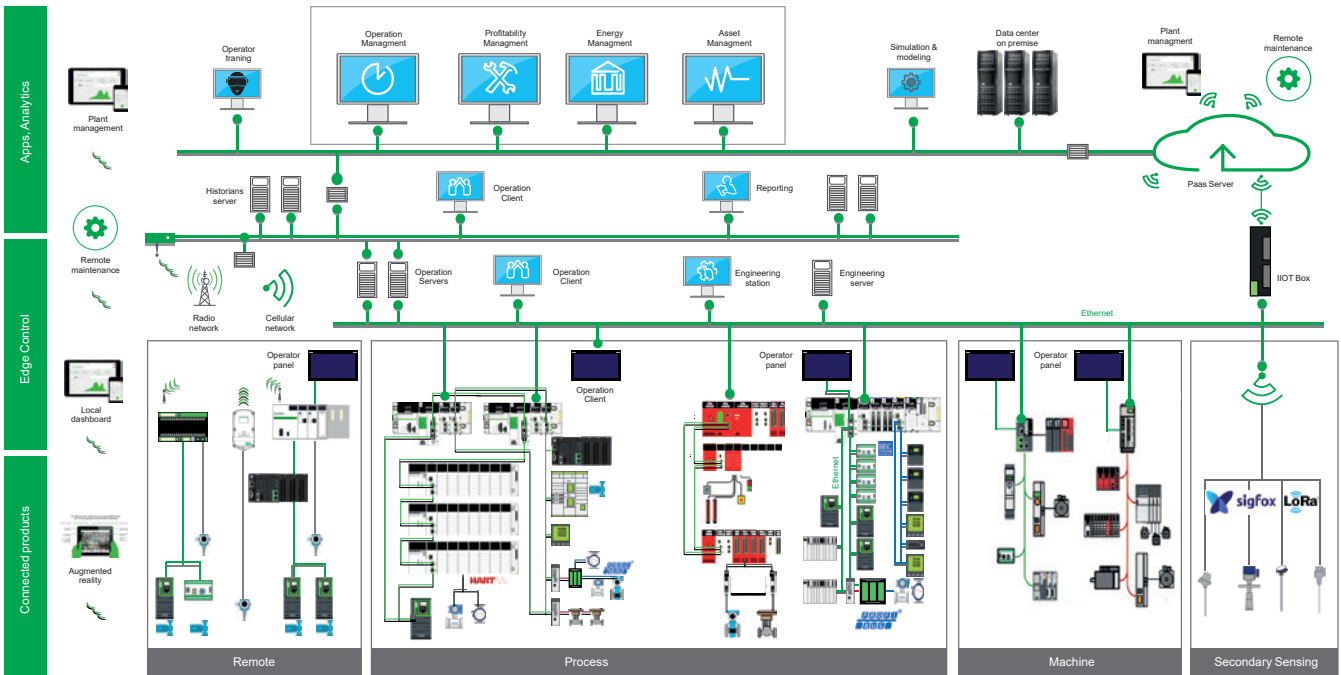

Modicon MC80 programmable logic controllers

Type of Modicon MC80		Programmable logic controller
		
Power supply	Nominal power supply Voltage range	24 V $\overline{\text{---}}$ isolated power supply module 20.4...28.8 V $\overline{\text{---}}$
Internal memory capacity	Internal user RAM Program, constants and symbols Located/unlocated data Memory retention	3840 KB 3590 KB 128 KB Yes, without battery
Number of Kinstructions executed per ms	100% Boolean 65% Boolean + 35% fixed arithmetic	16.7 Kinstructions/ms 12.5 Kinstructions/ms
Embedded real-time clock		Yes
Communication	Serial link CANopen Ethernet USB	1 RJ45 port in Modbus Serial link master/slave mode or in Character mode (non-isolated RS 232/RS 485, 0.3...19.2 Kbps) 247 devices maximum 1 9-way SUB-D port (16 slaves, 20 Kbps...1 Mbps) 2 RJ45 10BASE-T/100BASE-TX ports (FDR client, SNMP, RSTP, FTP server, Modbus TCP) 1 mini-B programming port (PC terminal)
High-speed counter		–
Integrated analog inputs	Number of channels Voltage range Current range	4 channels (voltage and current), 16 bits $\pm 10\text{ V}$, 0...10 V, 0...5 V, 1...5 V, $\pm 5\text{ V}$ 0...20 mA, 4...20 mA, $\pm 20\text{ mA}$
Integrated discrete inputs	Number of channels Voltage range	8 channels 19...30 V $\overline{\text{---}}$ sensor power supply
Integrated discrete outputs	Number of channels Voltage range Current	12 channels 19...30 V $\overline{\text{---}}$ pre-actuator power supply 2 A per channel, maximum 10 A per group
Software		Requires EcoStruxure Control Expert / Unity Pro version ≥ 8.1 with MC80 Hotfix
Environmental	Operation temperature Storage temperature Relative humidity Vibration	- 25...+ 70°C/- 13...+ 158°F - 40...+ 85°C/- 40...+ 185°F < 95% 3 g
References		BMKC8020301
Page		9

Programmable logic controller	
 	
24 V $\overline{\text{---}}$ isolated power supply module 20.4...28.8 V $\overline{\text{---}}$	
3840 KB 3590 KB 128 KB Yes, without battery	
16.7 Kinstructions/ms 12.5 Kinstructions/ms	
Yes	
1 RJ45 port in Modbus Serial link master/slave mode or in Character mode (non-isolated RS 232/RS 485, 0.3...19.2 Kbps) 247 devices maximum 1 9-way SUB-D port (16 slaves, 20 Kbps...1 Mbps) 2 RJ45 10BASE-T/100BASE-TX ports (FDR client, SNMP, RSTP, FTP server, Modbus TCP) 1 mini-B programming port (PC terminal)	
2 channels (12 inputs and 4 outputs, 60 KHz) with one shot counter, modulo loop counter, free large counter, frequency meter, event counter, period measurement and ration meter functions	
–	4 channels (voltage and current), 16 bits
–	$\pm 10\text{ V}$, 0...10 V, 0...5 V, 1...5 V, $\pm 5\text{ V}$
–	0...20 mA, 4...20 mA, $\pm 20\text{ mA}$
8 channels 19...30 V $\overline{\text{---}}$ sensor power supply	
8 channels	12 channels
19...30 V $\overline{\text{---}}$ pre-actuator power supply 0.5 A per channel, maximum 5 A per group	
2 A per channel, maximum 10 A per group	
Requires EcoStruxure Control Expert / Unity Pro version ≥ 8.1 with MC80 Hotfix	
- 25...+ 70°C/- 13...+ 158°F - 40...+ 85°C/- 40...+ 185°F < 95% 3 g	
BMKC8020310	BMKC8030311
9	

Modicon MC80 programmable logic controllers

Composition and software configuration

Presentation

The Modicon MC80 controller is an automated platform processor which manages the entire PLC station made up of discrete I/O functions, analog input functions, counter functions and communication functions.

The MC80 PLCs are available in 3 different variants:

- **BMKC8020301** controller with 8 discrete inputs, 12 discrete outputs and 4 analog inputs
- **BMKC8020310** controller with 8 discrete inputs, 8 discrete outputs and 2 highspeed counter channels
- **BMKC8030311** controller with 8 discrete inputs, 12 discrete outputs, 2 highspeed counter channels and 4 analog inputs

The communication buses and networks available in MC80 controllers are:

- CANopen
- Serial link
- Ethernet

The processors in this range have different features such as the number of I/Os or the number of high-speed counter channels.

Cybersecurity

The Modicon MC80 is a cyber-secure platform thanks to its advanced built-in cybersecurity features and its robustness under both extreme and common Ethernet conditions.

To meet cybersecurity requirements, the Modicon MC80 controller offers:

- Protection against unauthorized remote connections via an online editable control access list
- Protection against remote programming changes via a password
- An option to enable or disable the FTP service for firmware changes
- An option to enable or disable remote Run/Stop commands
- An option to enable or disable remote write commands
- Authentication and integrity of the firmware

Also, unnecessary services are disabled by default and security features are enabled by default.

Design and setup of Modicon MC80 applications

EcoStruxure Control Expert (renamed from previous Unity Pro) programming software \geq V8.1 (Small, Large and Extra Large versions) is required to set up the Modicon MC80 controller. It is mandatory to install the MC80 hotfix in addition to the software in the earlier versions. The MC80 hotfix version depends on the software version.

Note: For further information on Control Expert, please consult our "EcoStruxure Control Expert and OPC software" catalogue available on our website www.se.com.

Companion software

The Unity Loader is also available for MC80 controllers. It provides global management functions for the firmware, the application and the user data.

Depending on requirements, you may also need Unity EFB Toolkit software for developing EF and EFB libraries in C language and Unity Loader software for updating Control Expert projects and firmware.

Note: For further information on Unity Loader and EFB Toolkit, please consult our "PlantStruxure Control Expert and OPC software" catalogue available on our website www.schneider-electric.com.



Unity Loader

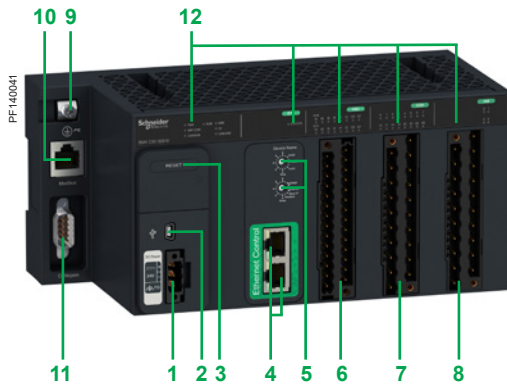

BMKC8030311

Description

Modicon MC80 programmable controllers have the followings on the front panel:

- 1 A galvanic isolated 24 V $\bar{\text{---}}$ power supply on the PLC to supply the whole module
- 2 A mini-B USB port (type 2.0). The USB port is a default terminal connection for application download/upload, programming tools connection, etc.
- 3 A reset button
- 4 2 Ethernet ports with an embedded Ethernet switch dedicated to Ethernet communication
- 5 2 rotary switches which enable IP addressing
- 6 2 high-speed counter channels with 6 discrete inputs and 2 discrete outputs per channel (available with **BMKC8020310** and **BMKC8030311** controllers)
- 7 8 discrete inputs and 8/12 discrete outputs
- 8 4 analog inputs (available with **BMKC8020301** and **BMKC8030311** controllers)
- 9 A grounding screw
- 10 An RJ45 connector for Modbus serial link, Character mode link, Modbus slave or Modbus RTU/ASCII master bus (RS232/RS485, 300...19200 bps). The serial link can be used for connecting the HMI and other serial devices.
- 11 A 9-way SUB-D connector for the integrated CANopen master bus, supports up to 16 devices
- 12 Display blocks comprising between 28 and 44 LEDs, depending on the model:
 - PWR (green): indicates the power supply status
 - RUN (green): indicates the module operating status
 - ERR (red): indicates the module's detected errors
 - SER COM (yellow): indicates the communication activity of the serial link
 - IO (red): indicates a detected error on the I/O ports
 - CAN RUN (green): indicates the CANopen operating status
 - CAN ERR (red): indicates detected errors on CANopen
 - ETH STS (green): indicates the Ethernet port operating status
 - CH0 and CH1: IA, IB, IS, IE, IP, IC, Q0, Q1 (green): indicate the state of the high-speed counter channels (**BMKC8020310** and **BMKC8030311** controllers only)
 - 0 to 7 (green): indicate the state of the discrete inputs
 - 16 to 27 (green): indicate the state of the discrete outputs
 - 0 to 3 (green): indicate the state of the analog inputs (**BMKC8020301** and **BMKC8030311** controllers only)

Modicon MC80 programmable logic controllers

Communication network and local controller cabinet architectures

Communication

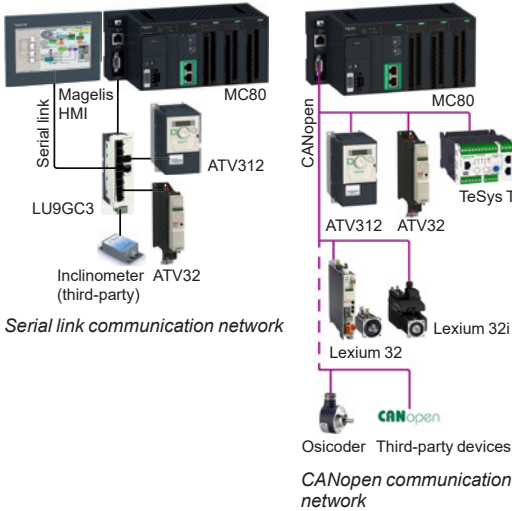

CANopen

The embedded CANopen master on Modicon MC80 controllers is available for connecting Schneider Electric devices and other third-party devices. The following devices are compatible with MC80 controllers:

- Altivar variable speed drives, Lexium servo drives and Osicoder
- Other third-party servo drives, variable speed drives or sensors

In addition, the MFB (Motion Function Block) integrated in Control Expert is able to set up motion control in the architectures with drives and servo drives for axis control. In compliance with PLCopen specifications, the MFB library makes motion programming with Control Expert, as well as axis diagnosis, both easy and flexible.

Serial link

Modicon MC80 controllers integrate a serial link which can be used with the Modbus RTU/ASCII master/slave protocol or with the Character mode protocol.

In Modbus mode, MC80 controller can be configured either in master mode or in slave mode for connecting with HMI or with serial field devices.

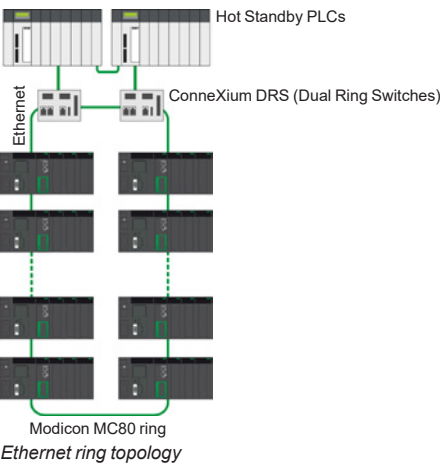

Ethernet ring topology

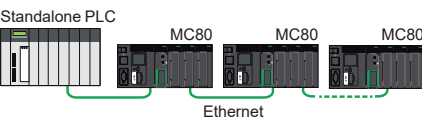

Ethernet daisy chain topology

Ethernet

Modicon MC80 controllers support Modbus/TCP, a complete open Ethernet protocol. The following communication services are available on MC80 for use in automation applications:

- DHCP
- FTP (for firmware upgrades only)
- Modbus/TCP messaging
- FDR (Fast Device Replacement)
- SNMP (Simple Network Management Protocol) V1
- Bandwidth management
- RSTP (Rapid Spanning Tree Protocol) for ring network

The RSTP function can be easily enabled and disabled in Control Expert for different Ethernet network topologies:

- Ring topology with RSTP enabled
- Daisy chain topology with RSTP disabled

Example of local controller cabinet architecture

The local controller cabinet architecture example on the right shows the types of devices that can be connected to the Modicon MC80 programmable logic controller.

Modicon MC80 could be used in below use cases:

- Local controller
- Remote IO control unit
- Gateway (Ethernet <-> Modbus Serial/CANopen)

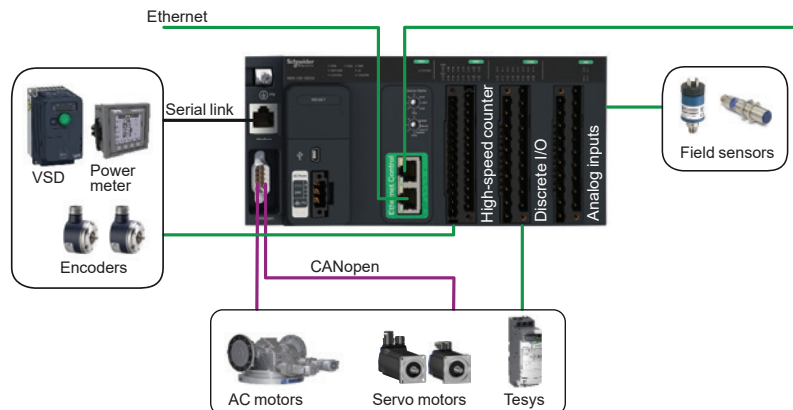

Note: For further information, please consult our "Modicon M580 automation platform", "Modicon M340 automation platform" and "ConneXium - Connecting Ethernet devices" catalogs available on our website www.se.com.

Modicon MC80 programmable logic controllers

Controllers, removable terminal blocks, grounding accessories and CANopen cabling system



BMKC8030311

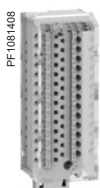

BMXFTB2820



STBXSP3000 + STBXSP3020



TSXCANTDM4



TSXCANKCDF90T



TSXCANKCDF90TP



TSXCANKCDF180T

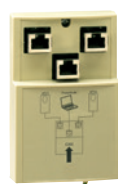

VW3CANTAP2

Modicon MC80 controllers

Description	Number of I/O	No. of high-speed counter channels	Reference	Weight kg/lb
Controller	8 discrete inputs 12 discrete outputs 4 analog inputs	–	BMKC8020301	1.050/ 2.310
	8 discrete inputs 8 discrete outputs	2	BMKC8020310	0.980/ 2.160
	8 discrete inputs 12 discrete outputs 4 analog inputs	2	BMKC8030311	1.150/ 2.540

Removable terminal blocks

Description	Type	Reference	Weight kg/lb
20-way removable terminal blocks	Cage clamp	BMXFTB2000	0.093/ 0.205
	Screw clamp	BMXFTB2010	0.075/ 0.165
	Spring	BMXFTB2020	0.060/ 0.132
28-way removable terminal blocks	Cage clamp	BMXFTB2800	0.111/ 0.245
	Spring	BMXFTB2820	0.080/ 0.176

Grounding accessories

Description	Use for	Sold in lots of	Reference	Weight kg/lb
Grounding kit	Grounding shielded cables Comprises 1 bar (1 m/3.21 ft long) and 2 lateral supports	–	STBXSP3000	–
Terminal for grounding kit	Fastening analog input module and counter module connection cables, cross-section 1.5...6 mm ² / AWG 16...10	10	STBXSP3020	–

Standard tap junctions and connectors

Designation	Description	Reference	Weight kg/lb
IP 20 CANopen tap junction	4 SUB-D ports. Screw terminal block for connecting the trunk cables Line termination	TSXCANTDM4	0.196/ 0.432
IP 20 connectors	90° angled	TSXCANKCDF90T	0.046/ 0.101
	9-way SUB-D. female	TSXCANKCDF180T	0.049/ 0.108
	Straight (1)		
	Right-angle with 9-way SUB-D for connecting a PC or diagnostic tool	TSXCANKCDF90TP	0.051/ 0.112
IP 20 CANopen tap junctions for Altivar and Lexium 32	2 RJ45 ports and 1 RJ45 port	VW3CANTAP2	–

Modicon MC80 programmable logic controllers

CANopen and serial link cabling systems

IP 20 standard cables and preassembled cordsets						
Designation	Description	Length m/ ft	Reference	Weight kg/ lb		
CANopen cables (AWG 24)	Standard, C€ marking: low smoke emission. Zero halogen. Flame-retardant (IEC 60332-1)	50/164.04	TSXCANCA50	4.930/ 10.869		
		100/328.08	TSXCANCA100	8.800/ 19.401		
		300/984.25	TSXCANCA300	24.560/ 54.145		
		50/164.04	TSXCANCB50	3.580/ 7.893		
		100/328.08	TSXCANCB100	7.840/ 17.284		
		300/984.25	TSXCANCB300	21.870/ 48.215		
	For harsh environments (3) or mobile installations, C€ marking: low smoke emission. Zero halogen. Flame-retardant (IEC 60332-1). Oil-resistant	50/164.04	TSXCANCD50	3.510/ 7.738		
		100/328.08	TSXCANCD100	7.770/ 17.130		
		300/984.25	TSXCANCD300	21.700/ 47.840		
		CANopen preassembled cordsets One 9-way female SUB-D connector at each end (AWG 24)	Standard, C€ marking: low smoke emission. Zero halogen. Flame-retardant (IEC 60332-1)	0.3/0.98	TSXCANCADD03	0.091/ 0.201
				1/3.28	TSXCANCADD1	0.143/ 0.315
				3/9.84	TSXCANCADD3	0.295/ 0.650
Standard, UL certification, C€ marking: flame-retardant (IEC 60332-2)	5/16.40		TSXCANCADD5	0.440/ 0.970		
	0.3/0.98		TSXCANCBDD03	0.086/ 0.190		
	1/3.28		TSXCANCBDD1	0.131/ 0.289		
3/9.84	TSXCANCBDD3	0.268/ 0.591				
5/16.40	TSXCANCBDD5	0.400/ 0.882				

Extension and adaptation elements for RS 485 serial link				
Designation	Description	Length m/ ft	Reference	Weight kg/ lb
Modbus splitter box	- 1 screw terminal block for trunk cable: D(A), D(B), $\frac{+}{-}$ and 0V - 8 x RJ45 connectors for tap-off - 2 x RJ45 connectors for series connection of LU9 GC3 splitter boxes Mounting on 35 mm/1.38 in. \perp rail	-	LU9GC3	0.500/ 1.102
T-junction boxes dedicated to Altivar and Lexium	- 2 x RJ45 connectors - 1 integrated cable with RJ45 connector	0.3/0.98	VW3A8306TF03	0.190/ 0.419
		1/3.28	VW3A8306TF10	0.210/ 0.463
Junction box Screw terminal block for trunk cable tap-off 1 x RJ45 connector for tap-off	- Isolation of the RS 485 serial link - Line termination (R = 120 Ω , C = 1 nF) - Line pre-polarization (1) (2 R = 620 Ω) 24 V \pm power supply (2) Mounting on 35 mm/1.38 in. \perp rail	-	TWDXCAISO	0.100/ 0.220
Tap junction 3 x RJ45 connectors	- Line termination (R = 120 Ω , C = 1 nF) - Line pre-polarization (1) (2 R = 620 Ω) Mounting on 35 mm/1.38 in. \perp rail	-	TWDXCAT3RJ	0.080/ 0.176



LU9GC3



VW3A8306TF03



TWDXCAISO



TWDXCAT3RJ

(1) Line polarization required for connection to the master Twido programmable controller.

(2) 24 V \pm power supply, or power supply via the serial port integrated in Modicon MC80 processors.

Modicon MC80 programmable logic controllers

Serial link cabling system, shielded connection cables and USB cordsets



XGSZ24

Extension and adaptation elements for RS 485 serial link

Designation	Description	Sold in lots of	Reference	Weight kg/ lb
RS 232C/RS 485 line converter without modem signals	24 V \pm 20 mA power supply, 19.2 Kbps Mounting on 35 mm/1.38 in. rail	–	XGSZ24	0.100/ 0.220
Line terminator	For RJ45 connector R = 120 Ω , C = 1 nF	2	VW3A8306RC	0.200/ 0.441

Shielded copper connection cables

EIA/TIA 568 shielded twisted pair cables for C€ market

Description	With connectors at both ends	Type	Length m/ ft	Reference	Weight kg/ lb
Straight-through copper cables C€ compatible	2 x RJ45 connectors For connection to terminal equipment (DTE)	Standard	2/6.56	490NTW00002	–
			5/16.40	490NTW00005	–
			12/39.37	490NTW00012	–
			40/131.23	490NTW00040	–
			80/262.47	490NTW00080	–
		Rugged	1/3.28	TCSECE3M3M1S4	–
			2/6.56	TCSECE3M3M2S4	–
			3/9.84	TCSECE3M3M3S4	–
			5/16.40	TCSECE3M3M5S4	–
Crossover copper cables C€ compatible	2 x RJ45 connectors For connection between hubs, switches, and transceivers	Standard	5/16.40	490NTC00005	–
			15/49.21	490NTC00015	–
			40/131.23	490NTC00040	–



TCSEC3M3M S4

Shielded twisted pair cables for UL market

Description	With connectors at both ends	Type	Length m/ ft	Reference	Weight kg/ lb
Straight-through copper cables UL compatible	2 x RJ45 connectors For connection to terminal equipment (DTE)	Standard	2/6.56	490NTW00002U	–
			5/16.40	490NTW00005U	–
			12/39.37	490NTW00012U	–
		Rugged	1/3.28	TCSECU3M3M1S4	–
			2/6.56	TCSECU3M3M2S4	–
			3/9.84	TCSECU3M3M3S4	–
			5/16.40	TCSECU3M3M5S4	–

Standard separate parts

Description	Use		Length m/ ft	Reference	Weight kg/ lb
	From	To			
Terminal port/USB cordsets	Mini B USB port on the Modicon MC80 controller	Type A USB port on PC terminal	1.8/ 5.91	BMXXCAUSBH018	0.065/ 0.143
			4.5/ 14.76	BMXXCAUSBH045	0.110/ 0.243



BMXXCAUSBH018

Modicon MC80 programmable logic controllers

Standards, certifications and environment conditions

Standards and certifications

Modicon MC80 PLCs have been developed to comply with the principal national and international standards concerning electronic equipment for industrial automation systems.

- Requirements specific to programmable controllers: functional characteristics, immunity, resistance, safety, etc.: **IEC/EN 61131-2**, UL and CSA standards for industry (**UL 61010-2-201**, **CSA E61131-2**).
- Requirements specific to electricity production automation system: **IEC/EN 61850-3**.
- Compliance with European Directives for CE marking:
 - Low Voltage: 2006/95/EC,
 - Electromagnetic Compatibility: 2004/108/EC.
- Ex areas:
 - For USA and Canada: Hazardous location class I, division 2, groups A, B, C and D
 - Up to date information on which certifications have been obtained are available on our website.

Characteristics

Service conditions and recommendations relating to environment

Temperature	Operation	°C	- 25...+ 70
	Storage	°C	- 40...+ 85
Relative humidity (without condensation)	Cyclical humidity	%	+ 5...+ 95 up to 55 °C
	Continuous humidity	%	+ 5...+ 93 up to 60 °C
Altitude	Operation	m	0...2000 (full specification: temperature and isolation) 2000...5000 (temperature derating: 1 °C / 400 m, isolation lost: 150 V ~ / 1000 m)
Supply voltage	Nominal voltage	V	~ 24
	Limit voltages	V	~ 20.4...28.8
	Nominal frequencies	Hz	–
	Limit frequencies	Hz	–

Protective treatment of Modicon MC80 PLCs

Modicon MC80 PLCs meet the requirements of “TC” treatment (*Treatment for all Climates*).

For installations in industrial production workshops or environments corresponding to “TH” treatment (*treatment for hot and humid environments*), Modicon MC80 PLCs must be embedded in envelopes with a minimum IP 54 protection.

Modicon MC80 PLCs themselves offer **protection to IP 20 level** and **protection against pins** (enclosed equipment). They can therefore be installed without an envelope in reserved-access areas which do not exceed **pollution level 2** (control room with no dust-producing machine or activity). The pollution level 2 does not take account of more severe environmental conditions: air pollution by dust, smoke, corrosive or radioactive particles, vapours or salts, attack by fungi, insects, ...

Environment tests		
Name of test	Standards	Levels
Immunity to LF interference (CE) (1)		
Voltage and frequency variations	IEC/EN 61131-2; IEC/EN 61000-6-2; IEC 61000-4-11	0.85...1.10 Un - 0.94...1.04 Fn; 4 steps t = 30 min
Direct voltage variations	IEC/EN 61131-2; IEC 61000-4-29	0.85...1.2 Un + ripple: 5 % peak; 2 steps t = 30 min
Third Harmonic	IEC/EN 61131-2	H3 (10 % Un), 0 ° / 180 °; 2 steps t = 5 min
Voltage interruptions	IEC/EN 61131-2; IEC/EN 61000-6-2; IEC 61000-4-11; IEC 61000-4-29	Power supply immunity: <ul style="list-style-type: none"> ■ 1ms for ~ PS1 / 10 ms for --- PS2 ■ Check operating mode for longer interruptions
	IEC/EN 61131-2; IEC/EN 61000-6-2; IEC 61000-4-11	For ~ PS2: <ul style="list-style-type: none"> ■ 20 % Un, t0: ½ period ■ 40 % Un, cycle 10/12 ■ 70 % Un, cycle 25/30 ■ 0 % Un, cycle 250/300
Voltage shut-down and start-up	IEC/EN 61131-2	<ul style="list-style-type: none"> ■ Un...0...Un; t = Un/60 s ■ Umin...0...Umin; t = Umin/5 s ■ Umin...0.9 Udl...Umin; t = Umin/60 s
Magnetic field	IEC/EN 61131-2; IEC/TS 61000-6-5; IEC 61000-4-8 (for MV power stations: IEC 61850-3)	Power frequency: 50/60 Hz, 100 A/m continuous...1000 A/m; t = 3 s; 3 axes
	IEC 61000-4-10 (for MV power stations: IEC 61850-3)	Oscillatory: 100 kHz...1 MHz, 100 A/m; t = 9 s; 3 axes
Conducted common mode disturbances range 0 Hz...150 kHz	IEC 61000-4-16 (for MV power stations: IEC 61850-3)	For remote systems: <ul style="list-style-type: none"> ■ 50/60 Hz and ---, 300 V, t = 1s ■ 50/60 Hz and ---, 30 V, t = 1 min ■ 5 Hz...150 kHz, sweep 3 V...30 V

Where:

- PS1 applies to PLC supplied by battery, PS2 applies to PLC energized from ~ or --- supplies
- Un: nominal voltage, Fn: nominal frequency, Udl: detection level when powered

Name of test	Standards	Levels
Immunity to HF interference (CE) (1) (2)		
Electrostatic discharges	IEC/EN 61131-2; IEC/EN 61000-6-2; IEC 61000-4-2	6 kV contact; 8 kV air; 6 kV indirect contact
Radiated radio frequency electromagnetic field	IEC/EN 61131-2; IEC/EN 61000-6-2; IEC 61000-4-3	10 V/m, 80 MHz...3 GHz Sinus amplitude modulated 80 %, 1 kHz + internal clock frequencies
Electrical fast transient bursts	IEC/EN 61131-2; IEC/EN 61000-6-2; IEC 61000-4-4	For --- main supplies: <ul style="list-style-type: none"> ■ 2 kV in common mode / 2 kV in wire mode For --- auxiliary supplies, ~ unshielded I/Os: <ul style="list-style-type: none"> ■ 2 kV in common mode For analog, --- unshielded I/Os, communication and all shielded lines: <ul style="list-style-type: none"> ■ 1 kV in common mode
Surge	IEC/EN 61131-2; IEC/EN 61000-6-2; IEC 61000-4-5	For --- main and auxiliary supplies: <ul style="list-style-type: none"> ■ 2 kV in common mode / 1 kV in differential mode For analog --- unshielded I/Os: <ul style="list-style-type: none"> ■ 0.5 kV in common mode / 0.5 kV in differential mode For communication and all shielded lines: <ul style="list-style-type: none"> ■ 1 kV in common mode
Conducted disturbances induced by radiated electromagnetic fields	IEC/EN 61131-2; IEC/EN 61000-6-2; IEC 61000-4-6	10 V; 0,15 MHz...80 MHz Sinus amplitude 80%, 1 kHz + spot frequencies
Damped oscillatory wave	IEC/EN 61131-2; IEC 61000-4-18	For --- main supplies: <ul style="list-style-type: none"> ■ 2.5 kV in common mode / 1 kV in differential mode For --- auxiliary supplies, analog, --- unshielded I/Os: <ul style="list-style-type: none"> ■ 1 kV in common mode / 0.5 kV in differential mode For communication and all shielded lines: <ul style="list-style-type: none"> ■ 0.5 kV in common mode

(1) Devices must be installed, wired and maintained in compliance with the instructions provided in the manual "Grounding and Electromagnetic Compatibility of PLC Systems".

(2) These tests are performed without a cabinet, with devices fixed on a metal grid and wired as per the recommendations in the manual "Grounding and Electromagnetic Compatibility of PLC Systems".

(CE): tests required by European directives CE and based on IEC/EN 61131-2 standards.

Environment tests (continued)		
Name of test	Standards	Levels
Electromagnetic emissions (CE) (1)		
Conducted emission	IEC/EN 61131-2; FCC part 15; IEC/EN 61000-6-4; CISPR 11 & 22, Class A, Group 1	150 kHz...500 kHz: quasi-peak 79 dB (µV/m); average 66 dB (µV/m) 500 kHz...30 MHz: quasi-peak 73 dB (µV/m); average 60 dB (µV/m)
Radiated emission	IEC/EN 61131-2; FCC part 15; IEC/EN 61000-6-4; CISPR 11 & 22, Class A, Group 1	30 MHz...230 MHz: quasi-peak 40 dB (µV/m) (at 10 m); 50 dB (µV/m) (at 3m) 230 MHz...1 GHz: quasi-peak 47 dB(µV/m) (at 10 m); 57 dB (µV/m) (at 3m)
Name of test	Standards	Levels
Immunity to climatic variations (1) (power on)		
Dry heat	IEC 60068-2-2 (Bb & Bd)	70 °C, t = 16 h
Cold	IEC 60068-2-1 (Ab & Ad)	0 °C...-25 °C, t = 16 h + power on at -25 °C
Damp heat, steady state (continuous humidity)	IEC 60068-2-78 (Cab)	60 °C, 93 % relative humidity, t = 96 h
Damp heat, cyclic (cyclical humidity)	IEC 60068-2-30 (Db)	55 °C...25 °C, 93...95 % relative humidity, 2 cycles t = 12 h + 12 h
Change of temperature	IEC 60068-2-14 (Nb)	-25 °C...70 °C, 5 cycles t = 6 h + 6 h
Name of test	Standards	Levels
Withstand to climatic variations (1) (power off)		
Dry heat	IEC/EN 61131-2; IEC 60068-2-2 (Bb & Bd) IEC/EN 60945	85 °C, t = 96 h
Cold	IEC/EN 61131-2; IEC 60068-2-1 (Ab & Ad)	-40 °C, t = 96 h
Damp heat, cyclic (cyclical humidity)	IEC/EN 61131-2; IEC 60068-2-30 (Db)	55 °C...25 °C, 93...95 % relative humidity, 2 cycles t = 12 h + 12 h
Change of temperature (thermal shocks)	IEC/EN 61131-2; IEC 60068-2-14 (Na)	-40 °C...85 °C, 5 cycles t = 3 h + 3 h

(1) Devices must be installed, wired and maintained in compliance with the instructions provided in the manual "Grounding and Electromagnetic Compatibility of PLC Systems".

(CE): tests required by European directives CE and based on IEC/EN 61131-2 standards.

Environment tests (continued)		
Name of test	Standards	Levels
Immunity to mechanical constraints (1) (power on)		
Sinusoidal vibrations	IEC/EN 61131-2; IEC 60068-2-6 (Fc)	Basic IEC/EN 61131-2: 5 Hz...150 Hz, ± 3.5 mm amplitude (5 Hz...8.4 Hz), 1g (8.4 Hz...150 Hz) Specific profile: 5 Hz...150 Hz, ± 10.4 mm amplitude (5 Hz...8.4 Hz), 3 g (8.4 Hz...150 Hz) For basic and specific, endurance: 10 sweep cycles for each axis
Shocks	IEC/EN 61131-2; IEC 60068-2-27 (Ea)	30 g, 11 ms; 3 shocks/direction/axis (2) 25 g, 6 ms; 100 bumps/direction/axis (bumps) (3)
Free fall during operation	IEC/EN 61131-2; IEC 60068-2-32 (Ed Method 1)	1 m, 2 falls
Name of test	Standards	Levels
Withstand to mechanical constraints (power off)		
Random free fall with packaging	IEC/EN 61131-2; IEC 60068-2-32 (Method 1)	1 m, 5 falls
Flat free fall	IEC/EN 61131-2; IEC 60068-2-32 (Ed Method 1)	10 cm, 2 falls
Controlled free fall	IEC/EN 61131-2; IEC 60068-2-31 (Ec)	30 ° or 10 cm, 2 falls
Plugging / Unplugging	IEC/EN 61131-2	For modules and connectors: Operations: 50 for permanent connections, 500 for non-permanent connections
Name of test	Standards	Levels
Equipment and personnel safety (1) (CE)		
Dielectric strength and insulation resistance	IEC/EN 61131-2; IEC 61010-2-201; UL; CSA	Dielectric: 2 Un + 1000 V; t = 1 min Insulation: Un ≤ 50 V: 10 MΩ, 50 V ≤ Un ≤ 250 V: 100 MΩ
Continuity of earth	IEC/EN 61131-2; IEC 61010-2-201; UL; CSA	30 A, R ≤ 0,1Ω; t = 2min
Leakage current	UL; CSA	≤ 3.5 mA after disconnecting
Protection offered by enclosures	IEC/EN 61131-2; IEC 61010-2-201	IP20 and protection against standardized pins
Impact withstand	IEC/EN 61131-2; IEC 61010-2-201; UL; CSA	Sphere of 500 g, fall from 1.30 m (energy 6.8 J minimum)
Stored energy injury risk	IEC/EN 61131-2; IEC 61010-2-201	Non permanent connection: 37 % Un after 1 s Permanent connection: 37 % Un after 10 s
Overload	IEC/EN 61131-2; IEC 61010-2-201; UL; CSA	50 cycles, Un, 1.5 In; t = 1 s ON + 9 s OFF
Endurance	IEC/EN 61131-2; IEC 61010-2-201; UL; CSA	In, Un; 12 cycles: t = 100 ms ON + 100 ms OFF, 988 cycles: t = 1 s ON + 1 s OFF, 5000 cycles: t = 1 s ON + 9 s OFF
Temperature rise	IEC/EN 61131-2; UL; CSA; ATEX; IECEx	Ambient temperature 70 °C

(1) Devices must be installed, wired and maintained in compliance with the instructions provided in the manual "Grounding and Electromagnetic Compatibility of PLC Systems".

(2) In case of using fast actuators (response time ≤ 5 ms) driven by relay outputs: 15 g, 11 ms; 3 shocks/direction/axis.

(3) In case of using fast actuators (response time ≤ 15 ms) driven by relay outputs: 15 g, 6 ms; 100 bumps/direction/axis.

(CE): tests required by European directives CE and based on IEC/EN 61131-2 standards.

Technical appendices

Automation product certifications

EC regulations

Some countries require certain electrical components to undergo certification by law. This certification takes the form of a certificate of conformity to the relevant standards and is issued by the official body in question. Where applicable, certified devices must be labeled accordingly. Use of electrical equipment on board merchant vessels generally implies that it has gained prior approval (i.e. certification) by certain shipping classification societies.









Abbreviation	Certification body	Country
CSA	Canadian Standards Association	Canada
RCM	Australian Communications and Media Authority	Australia, New Zealand
EAC	Eurasian conformity	Russia and customs union
UL	Underwriters Laboratories	USA

Abbreviation	Classification authority	Country
IACS	International Association of Classification Societies	International
ABS	American Bureau of Shipping	USA
BV	Bureau Veritas	France
DNV	Det Norske Veritas	Norway
GL	Germanischer Lloyd	Germany
LR	Lloyd's Register	UK
RINA	Registro Italiano Navale	Italy
RMRS	Russian Maritime Register of Shipping	Russia
RRR	Russian River Register	Russia
CCS	China Classification Society	China
KRS	Korean Register of Shipping	Korea
Class NK	Nippon Kaiji Kyokai	Japan

Note: Following the merger of the DNV and GL certification bodies, DNV/GL has been issued as a single certificate since 2016.

The following tables provide an overview of the situation as of December 2018, in terms of which certifications (listed next to their respective bodies) have been granted or are pending for our automation products.

Up-to-date information on which certifications have been obtained by products bearing the Schneider Electric brand can be viewed on our website: www.schneider-electric.com

Product certifications							
Certified Certification pending	Certifications						
					Hazardous locations (1) Class I, div 2	  	
	UL	CSA	RCM	EAC		(6)	TÜV Rheinland
	USA	Canada	Australia	Russia	USA, Canada		
Modicon OTB							
Modicon STB					CSA (8)	Zone 2 (2)(5)	
Modicon Telefast ABE 7							
ConneXium					(2)		
Magelis iPC/GTW		(3)		(2)	(3)	Zone 2/22 (2)	
Magelis XBT GT		(3)		(2)	(2) (3)	Zone 2/22 (2)(5)	
Magelis XBT GK		(3)			(3)		
Magelis XBT N/R/RT					CSA	Zone 2/22 (2)(5)	
Magelis HMI GTO		(3)		(2)	(3)	Zone 2/22 (2)	
Magelis HMI STO/STU		(3)		(2)	(2)(3)	Zone 2/22 (2)	
Modicon MC80							
Modicon M340					CSA (8)	Zone 2/22 (2)	
Modicon M580					CSA (8)	Zone 2/22 (2)	
Modicon M580 Safety					CSA (8)	Zone 2/22 (2)	SIL 3, Cat.4, PLe
Modicon X80 I/O					CSA (8)	Zone 2/22 (2)	
Modicon Momentum					CSA (8)		
Modicon Premium				(2)	CSA		
Modicon Quantum				(2)	CSA (8)	Zone 2/22 (2)	
Modicon Quantum Safety				(2)	CSA	Zone 2/22 (2)	SIL 2, SIL 3 (7)
Preventa XPSMF							SIL 3 (7)
Modicon TSX Micro					CSA		
Phaseo	(3)						
Twido	(4)	(4)			CSA/UL (4)		

(1) Hazardous locations: According to ANSI/ISA 12.12.01 and/or CSA 22.2 No. 213, and/or FM 3611, certified products are only approved for use in hazardous locations categorized as Class I, division 2, groups A, B, C, and D, or in non-classified locations.

(2) Depends on product; please visit our website: www.schneider-electric.com.

(3) North American certification cULus (Canada and USA).

(4) Except for AS-Interface module TWD NOI 10M3, CE only.

(5) For zones not covered by this specification, Schneider Electric offers a solution as part of the TPP (Technology Partner Program). Please contact our Customer Care Center.

(6) Certified by INERIS. Refer to the instructions supplied with each ATEX and/or IECEx certified product.

(7) According to IEC 61508. Certified by TÜV Rheinland for integration into a safety function of up to SIL 2 or SIL 3.











(8) CSA Hazardous Location according to ANSI/ISA 12.12.01, CSA 22.2 No. 213, and FM 3611.

Technical appendices

Automation product certifications

EC regulations

Merchant navy certifications

Certified Certification pending	Shipping classification societies										
											
	USA	France	Norway	Germany	Korea	Great Britain	Italy	Russia	Russia	China	Japan
Modicon OTB											
Modicon STB											
Modicon Telefast ABE 7											
ConneXium											
Magelis iPC/GTW											
Magelis XBT GT											
Magelis XBT GK											
Magelis XBT N/R											
Magelis XBT RT											
Magelis HMI GTO											
Magelis HMI STO/STU											
Modicon MC80											
Modicon M340											
Modicon M580											
Modicon M580 Safety											
Modicon X80 I/O											
Modicon Momentum											
Modicon Premium											
Modicon Quantum											
Modicon TSX Micro											
Phaseo											
Twido											

EC regulations

European Directives

The open nature of the European markets assumes harmonization between the regulations set by the member states of the European Union. European Directives are texts intended to remove restrictions on free circulation of goods and must be applied within all European Union states.

Member states are obligated to incorporate each Directive into their national legislation, and to simultaneously withdraw any regulations that contradict it.

Directives - and particularly those of a technical nature with which we are concerned - merely set out the objectives to be fulfilled (referred to as "essential requirements"). Manufacturers are responsible for taking the necessary measures to establish that their products conform to the requirements of each Directive applicable to their equipment.

As a general rule, manufacturers certify compliance with the essential requirements of the Directive(s) that apply to their products by applying a CE mark. The CE mark is affixed to our products where applicable.

Significance of the CE mark

The CE mark on a product indicates the manufacturer's certification that the product conforms to the relevant European Directives; this is a prerequisite for placing a product that is subject to the requirements of one or more Directives on the market and allowing its free circulation within European Union countries. The CE mark is intended for use by those responsible for regulating national markets.

Where electrical equipment is concerned, conformity to standards indicates that the product is fit for use. Only a warranty by a well-known manufacturer can provide reassurance of a high level of quality.

As far as our products are concerned, one or more Directives are likely to apply in each case; in particular:

- The Low Voltage Directive (2014/35/EU)
- The Electromagnetic Compatibility Directive (2014/30/EU)
- The ATEX CE Directive (2014/34/EU)
- The Machinery Directive (2006/42/EU)

Hazardous substances

These products are compatible with:

- The WEEE Directive (2012/19/EU)
- The RoHS Directive (2011/65/EU)
- The China RoHS Directive (Standard GB/T 26572-2011)
- REACH regulations (EC No. 1907/2006)

Note: Documentation on sustainable development is available on our website www.schneider-electric.com (product environmental profiles and instructions for use, RoHS and REACH directives).

End of life (WEEE)

End of life products containing electronic cards must be dealt with by specific treatment processes.

When products containing backup batteries are unusable or at end of life they must be collected and treated separately. Batteries do not contain a percentage by weight of heavy metals above the limit specified by European Directive 2013/56/EU.

A		TWDXCAT3RJ	10
490NTC00005	11		
490NTC00015	11	V	
490NTC00040	11	VW3A8306RC	11
490NTW00002	11	VW3A8306TF03	10
490NTW00002U	11	VW3A8306TF10	10
490NTW00005	11	VW3CANTAP2	9
490NTW00005U	11	X	
490NTW00012	11	XGSZ24	11
490NTW00012U	11		
490NTW00040	11		
490NTW00080	11		
B			
BMKC8020301	9		
BMKC8020310	9		
BMKC8030311	9		
BMXFTB2000	9		
BMXFTB2010	9		
BMXFTB2020	9		
BMXFTB2800	9		
BMXFTB2820	9		
BMXXCAUSBH018	11		
BMXXCAUSBH045	11		
L			
LU9GC3	10		
S			
STBXSP3000	9		
STBXSP3020	9		
T			
TCSECE3M3M1S4	11		
TCSECE3M3M2S4	11		
TCSECE3M3M3S4	11		
TCSECE3M3M5S4	11		
TCSECU3M3M1S4	11		
TCSECU3M3M2S4	11		
TCSECU3M3M3S4	11		
TCSECU3M3M5S4	11		
TSXCANCA50	10		
TSXCANCA100	10		
TSXCANCA300	10		
TSXCANCADD1	10		
TSXCANCADD03	10		
TSXCANCADD3	10		
TSXCANCADD5	10		
TSXCANCB50	10		
TSXCANCB100	10		
TSXCANCB300	10		
TSXCANCBDD1	10		
TSXCANCBDD03	10		
TSXCANCBDD3	10		
TSXCANCBDD5	10		
TSXCANCD50	10		
TSXCANCD100	10		
TSXCANCD300	10		
TSXCANKCDF90T	9		
TSXCANKCDF90TP	9		
TSXCANKCDF180T	9		
TSXCANTDM4	9		
TWDXCAISO	10		

Life Is On



Learn more about our products at
www.schneider-electric.com

The information provided in this documentation contains general descriptions and/or technical characteristics of the performance of the products contained herein. This documentation is not intended as a substitute for and is not to be used for determining suitability or reliability of these products for specific user applications. It is the duty of any such user or integrator to perform the appropriate and complete risk analysis, evaluation and testing of the products with respect to the relevant specific application or use thereof. Neither Schneider Electric nor any of its affiliates or subsidiaries shall be responsible or liable for misuse of the information contained herein.

Design: Schneider Electric
Photos: Schneider Electric

Schneider Electric Industries SAS

Head Office
35, rue Joseph Monier - CS 30323
F-92500 Rueil-Malmaison Cedex
France

DIA6ED2141001EN
July 2020 - V3.0