

GV3L25

TeSys Deca Manual Starter and Protector, magnetic circuit protector, rotary handle, 25 A, EverLink BTR connectors



Main

Range	TeSys Deca
Product name	TeSys GV3 TeSys Deca
Product or Component Type	Motor circuit breaker
Device short name	GV3L
Device Application	Motor protection
Trip unit technology	Magnetic

Complementary

Poles description	3P
Network type	AC
Utilisation category	Category A IEC 60947-2
Network frequency	50/60 Hz
Fixing mode	35 mm symmetrical DIN rail clipped Panel screwed with 3 x M4 screws)
Motor power kW	11 kW 400/415 V AC 50/60 Hz 15 kW 500 V AC 50/60 Hz 18.5 kW 690 V AC 50/60 Hz
Breaking capacity	100 KA Icu 230/240 V AC 50/60 Hz 100 KA Icu 400/415 V AC 50/60 Hz 50 KA Icu 440 V AC 50/60 Hz 12 KA Icu 500 V AC 50/60 Hz 6 kA Icu 690 V AC 50/60 Hz
[Ics] rated service short-circuit breaking capacity	100 % 230/240 V AC 50/60 Hz 100 % 400/415 V AC 50/60 Hz 100 % 440 V AC 50/60 Hz 50 % 500 V AC 50/60 Hz 50 % 690 V AC 50/60 Hz
Control Type	Rotary handle
Line Rated Current	25 A
Magnetic tripping current	350 A
[Ue] rated operational voltage	690 V AC 50/60 Hz IEC 60947-2
[Ui] rated insulation voltage	690 V AC 50/60 Hz IEC 60947-2
[Uimp] rated impulse withstand voltage	6 kV IEC 60947-2
Suitability for isolation	Yes IEC 60947-1
Power dissipation per pole	8 W
Mechanical durability	50000 cycles
Electrical durability	50000 cycles AC-3 415 V In
Tightening torque	44.25 lbf.in (5 N.m) screw clamp terminal
Width	2.17 in (55 mm)
Height	5.20 in (132 mm)
Depth	5.35 in (136 mm)
Net Weight	2.12 lb(US) (0.96 kg)
Color	Dark grey

The information provided in this documentation contains general descriptions and/or technical characteristics of the performance of the products contained herein. This documentation is not intended as a substitute for and is not to be used for determining suitability or reliability of these products for specific user applications. It is the duty of any such user or integrator to perform the appropriate and complete risk analysis, evaluation and testing of the products with respect to the relevant specific application or use thereof. Neither Schneider Electric Industries SAS nor any of its affiliates or subsidiaries shall be responsible or liable for misuse of the information contained herein.

Environment

Standards	EN/IEC 60947-2 EN/IEC 60947-4-1 UL 60947-4-1 CSA C22.2 No 60947-4-1
Product Certifications	CCC UL CSA EAC LROS (Lloyds register of shipping) BV ABS DNV-GL UKCA
IP degree of protection	IP20 IEC 60529
Climatic withstand	IACS E10
Ambient Air Temperature for Storage	-40...176 °F (-40...80 °C)
Fire resistance	1760 °F (960 °C) IEC 60695-2-11
Ambient air temperature for operation	-4...140 °F (-20...60 °C)
Mechanical robustness	Shocks 15 Gn for 11 ms contactor open Shocks 30 Gn for 11 ms contactor closed Vibrations 4 Gn, 5...300 Hz
Operating altitude	9842.52 ft (3000 m)

Ordering and shipping details

Category	22366-MAN STR PROTECTORS-GV1/GV3
Discount Schedule	I11
GTIN	3389119405423
Returnability	No
Country of origin	FR

Packing Units

Unit Type of Package 1	PCE
Number of Units in Package 1	1
Package 1 Height	6.30 in (16 cm)
Package 1 Width	2.56 in (6.5 cm)
Package 1 Length	5.71 in (14.5 cm)
Package 1 Weight	35.13 oz (996 g)
Unit Type of Package 2	P06
Number of Units in Package 2	60
Package 2 Height	29.53 in (75 cm)
Package 2 Width	23.62 in (60 cm)
Package 2 Length	31.50 in (80 cm)
Package 2 Weight	160.41 lb(US) (72.76 kg)

Offer Sustainability

Sustainable offer status	Green Premium product
California proposition 65	WARNING: This product can expose you to chemicals including: Antimony oxide & Antimony trioxide, which is known to the State of California to cause cancer. For more information go to www.P65Warnings.ca.gov
REACH Regulation	REACH Declaration
EU RoHS Directive	Compliant EU RoHS Declaration
Mercury free	Yes
China RoHS Regulation	China RoHS Declaration
RoHS exemption information	Yes
Environmental Disclosure	Product Environmental Profile

Circularity Profile

 [End Of Life Information](#)

WEEE

The product must be disposed on European Union markets following specific waste collection and never end up in rubbish bins.

Contractual warranty

Warranty

18 months

Tripping Curves for GV3L Combined with Thermal Overload Relay LRD33

Average Operating time at 20 °C without Prior Current Flow

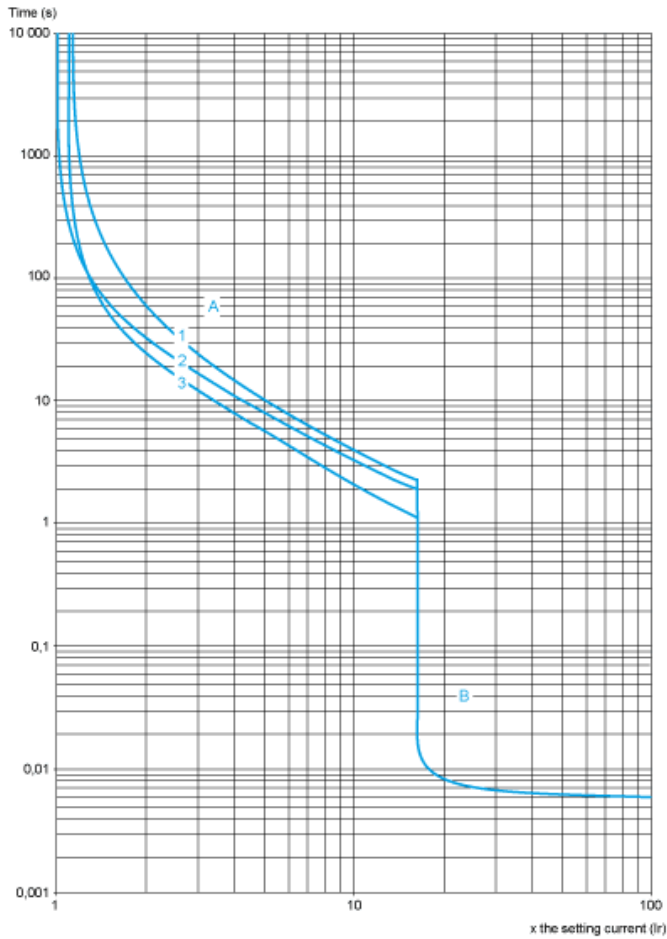

- 1 3 poles from cold state
- 2 2 poles from cold state
- 3 3 poles from hot state
- A Thermal overload relay protection zone
- B GV3L protection zone

Current Limitation on Short-Circuit for GV3L (3-Phase 400/415 V)

Dynamic Stress

$I_{peak} = f(\text{prospective } I_{sc}) \text{ at } 1.05 U_e = 435 \text{ V}$

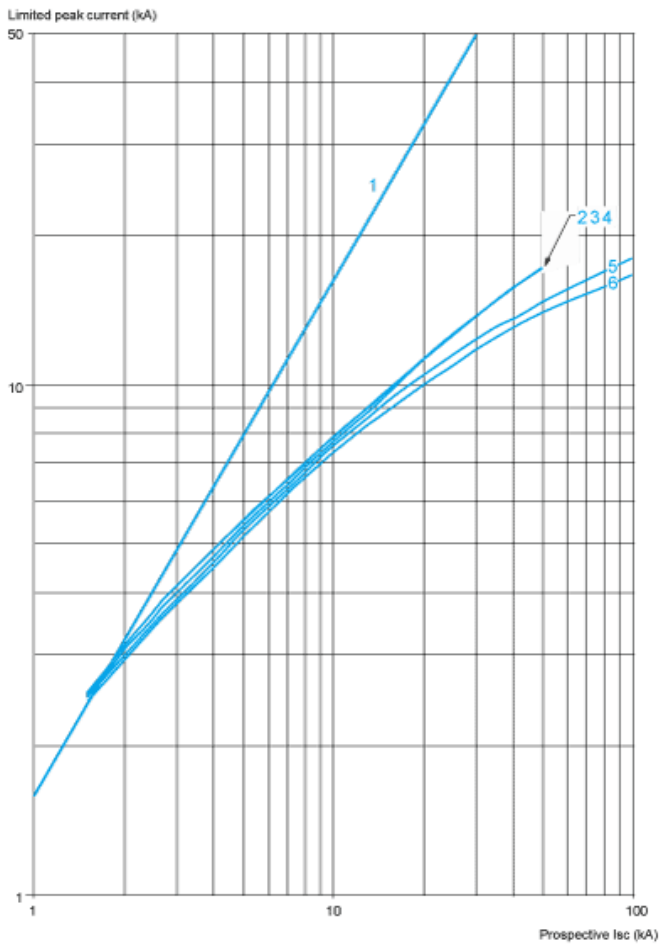

- 1 Maximum peak current
- 2 GV3L80 - GV3L73 - GV3L65
- 3 GV3L50
- 4 GV3L40
- 5 GV3L32
- 6 GV3L25

Thermal Limit on Short-Circuit for GV3L

Thermal Limit in A^2s

Sum of $I^2dt = f$ (prospective Isc) at $1.05 U_e = 435 V$

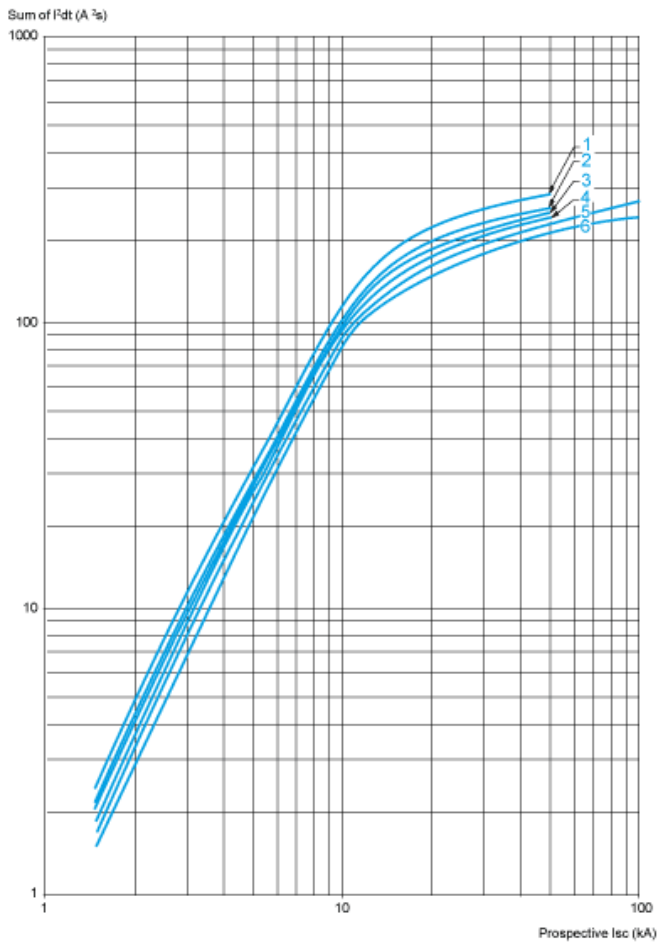

- 1 GV3L73 - GV3L80
- 2 GV3L65
- 3 GV3L50
- 4 GV3L40
- 5 GV3L32
- 6 GV3L25

GV3L, GV3P

Dimensions

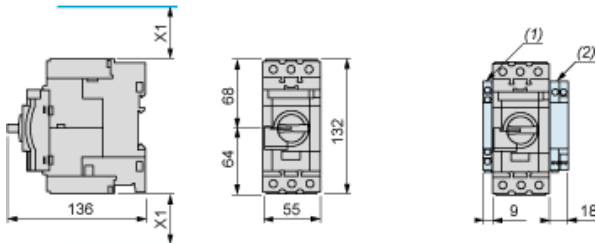

- (1) Blocks GVAN.., GVAD.. and GVAM11.
- (2) Blocks GV3AU.. and GV3AS..

X1 = Electrical clearance (ISC max) 40 mm for $U_e \leq 500$ V, 50 mm for $U_e \leq 690$ V

NOTE: Leave a space of 9 mm between 2 circuit breakers: either an empty space or side-mounting add-on contact blocks. Side by side mounting is possible up to 40 °C.

Mounting with Tesys contactor LC1D40A...D80A and relay LR3D313...380 ^{(1) (2) (3)}

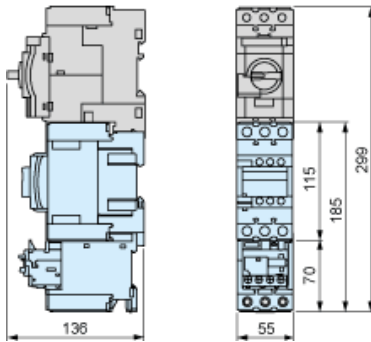

- (1) Mountings with c.b. up to GV3L73, GV3P73.
- (2) For GV3L80, GV3P80 use cable between components for dissipating heat. Consult online datasheets for values.
- (3) S-shape busbar system suitable up to 73 A.

Side by side mounting with Tesys contactor LC1D40A...D73A (S-shape busbar system GV3S⁽¹⁾)

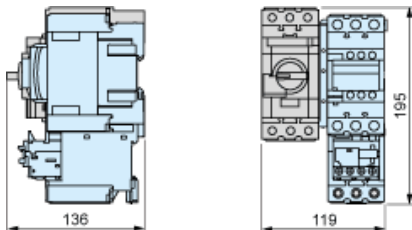

- (1) Mountings with c.b. up to GV3L73, GV3P73.

Mounting on Rail AM1 DE200 or AM1 ED201

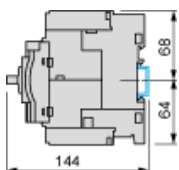

Panel Mounting, using M4 Screws

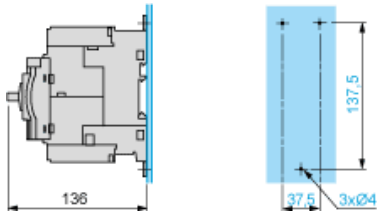

Mounting on Pre-Slotted Plate AM1 PA

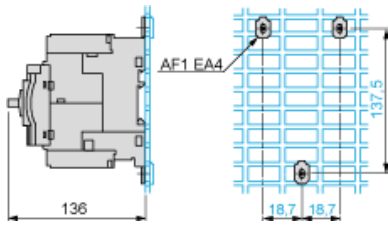

Mounting of External Operator GV3APN01, GV3APN02 or GV3APN04 for Motor Circuit Breakers GV3L

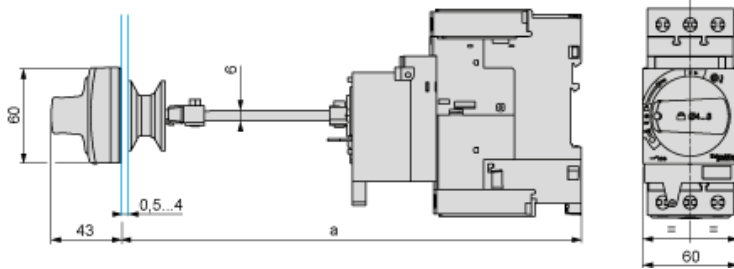

Door cut-out

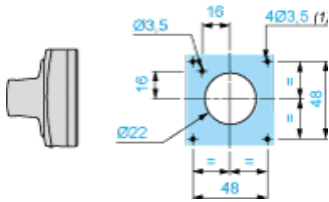

(1) For IP65 only.

Mounting of External Operator GVAPH03 for Motor Circuit Breakers GV3L

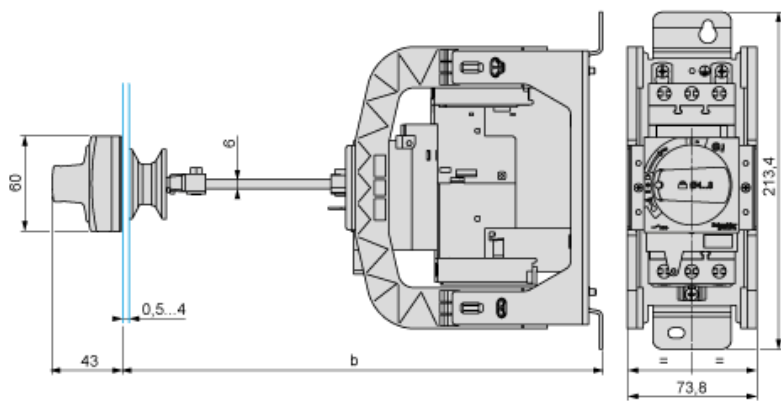

	b	
	Minimum	Maximum
GV3APN.. + GVAPH03	200	300
GV3APN.. + GVAPH03 + GVAPK12	300	492

Door cut-out

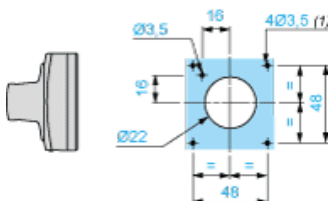

(1) For IP65 only.

GV3L••

