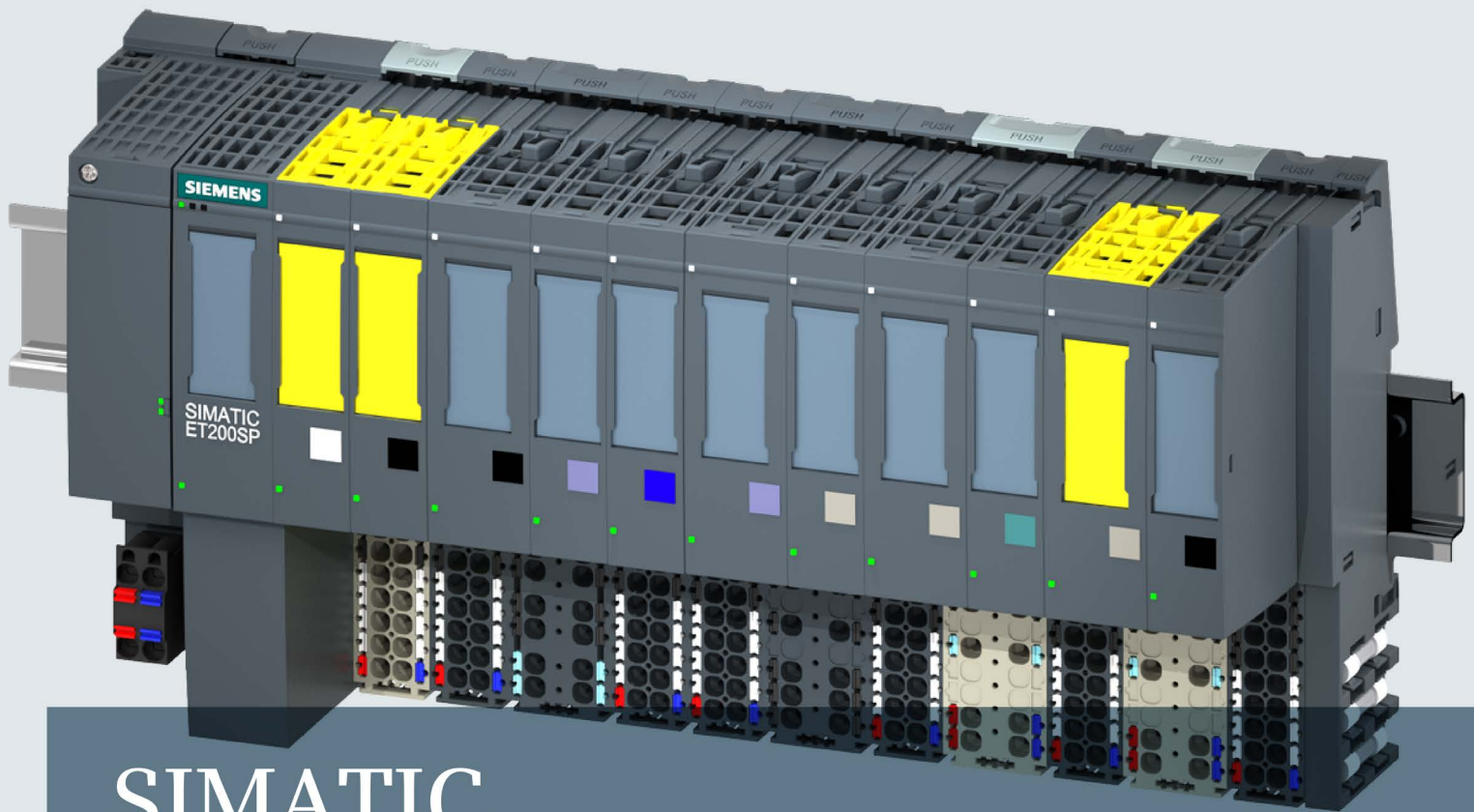


SIEMENS



SIMATIC

ET 200SP

ET 200SP distributed I/O system

System manual

Edition

12/2015

Answers for industry.

SIEMENS

SIMATIC

ET 200SP Distributed I/O system




System Manual

Preface	
Guide to documentation	1
System overview	2
Application planning	3
Installation	4
Wiring	5
Configuring	6
Basics of program execution	7
Protection	8
Configuration control (option handling)	9
Commissioning	10
SIMATIC memory card	11
Maintenance	12
Test functions and eliminating problems	13
Technical specifications	14
Dimension drawings	A
Accessories/spare parts	B
Calculating the leakage resistance	C
Service & Support	D

Legal information

Warning notice system

This manual contains notices you have to observe in order to ensure your personal safety, as well as to prevent damage to property. The notices referring to your personal safety are highlighted in the manual by a safety alert symbol, notices referring only to property damage have no safety alert symbol. These notices shown below are graded according to the degree of danger.

 DANGER
indicates that death or severe personal injury will result if proper precautions are not taken.
 WARNING
indicates that death or severe personal injury may result if proper precautions are not taken.
 CAUTION
indicates that minor personal injury can result if proper precautions are not taken.
NOTICE
indicates that property damage can result if proper precautions are not taken.


If more than one degree of danger is present, the warning notice representing the highest degree of danger will be used. A notice warning of injury to persons with a safety alert symbol may also include a warning relating to property damage.

Qualified Personnel

The product/system described in this documentation may be operated only by **personnel qualified** for the specific task in accordance with the relevant documentation, in particular its warning notices and safety instructions. Qualified personnel are those who, based on their training and experience, are capable of identifying risks and avoiding potential hazards when working with these products/systems.

Proper use of Siemens products

Note the following:

 WARNING
Siemens products may only be used for the applications described in the catalog and in the relevant technical documentation. If products and components from other manufacturers are used, these must be recommended or approved by Siemens. Proper transport, storage, installation, assembly, commissioning, operation and maintenance are required to ensure that the products operate safely and without any problems. The permissible ambient conditions must be complied with. The information in the relevant documentation must be observed.

Trademarks

All names identified by ® are registered trademarks of Siemens AG. The remaining trademarks in this publication may be trademarks whose use by third parties for their own purposes could violate the rights of the owner.

Disclaimer of Liability

We have reviewed the contents of this publication to ensure consistency with the hardware and software described. Since variance cannot be precluded entirely, we cannot guarantee full consistency. However, the information in this publication is reviewed regularly and any necessary corrections are included in subsequent editions.

Preface

Purpose of the documentation

This documentation provides important information on configuring, installing, wiring and commissioning the ET 200SP distributed I/O system.

Basic knowledge required

A basic knowledge of automation technology is required to understand the documentation.

Validity of the documentation

This documentation applies to the distributed I/O system, ET 200SP.

Conventions

Please pay particular attention to notes highlighted as follows:

Note

Notes contain important information on the product, handling the product or on part of the documentation to which you should pay particular attention.

Special information

Note

Important note for maintaining operational safety of your plant

Plants with safety-related features are subject to special operational safety requirements on the part of the operator. Even suppliers are required to observe special measures during product monitoring. This is why we inform you about product developments and features that are or may become important for the operation of plants with regard to safety in a special newsletter. You need to subscribe to the corresponding newsletter to ensure that you always remain up-to-date and are able to make any necessary changes to your plant regarding operational safety should the need arise. Please go online (<https://www.automation.siemens.com/WW/newsletter/guiThemes2Select.aspx?HTTPS=RE DIR&subjectID=2>) and register for the following newsletters:

- SIMATIC S7-300/S7-300F
- SIMATIC S7-400/S7-400H/S7-400F/FH
- SIMATIC S7-1500/SIMATIC S7-1500F
- Distributed I/O
- SIMATIC Industrial Software

Select the "Current" check box for these newsletters.

Note

When F-CPU's are used in safety mode, note the description of the fail-safe system SIMATIC Safety Programming and Operating Manual SIMATIC Safety - Configuring and Programming (<http://support.automation.siemens.com/WW/view/en/54110126>).

Recycling and disposal

The products are low in pollutants and can be recycled. For environmentally compliant recycling and disposal of your electronic waste, please contact a company certified for the disposal of electronic waste.

Additional support

- Information about the technical support available can be found in the appendix to this documentation (Page 251).
- The technical documentation for the individual SIMATIC products and systems is available on the Internet (<http://www.siemens.com/simatic-tech-doku-portal>).
- The online catalog and the ordering system are available on the Internet (<https://mall.industry.siemens.com>).

Security information

Siemens provides products and solutions with industrial security functions that support the secure operation of plants, solutions, machines, equipment and/or networks. They are important components in a holistic industrial security concept. With this in mind, Siemens' products and solutions undergo continuous development. Siemens recommends strongly that you regularly check for product updates.

For the secure operation of Siemens products and solutions, it is necessary to take suitable preventive action (e.g. cell protection concept) and integrate each component into a holistic, state-of-the-art industrial security concept. Third-party products that may be in use should also be considered. You can find more information about industrial security on the Internet (<http://www.siemens.com/industrialsecurity>).

To stay informed about product updates as they occur, sign up for a product-specific newsletter. You can find more information on the Internet (<http://support.automation.siemens.com>).

Table of contents

	Preface	4
1	Guide to documentation	11
2	System overview	13
2.1	What is the SIMATIC ET 200SP distributed I/O system?	13
2.2	What are fail-safe automation systems and fail-safe modules?	16
2.3	How are SIMATIC Safety F-systems structured with ET 200SP?	17
2.4	Components.....	20
3	Application planning	26
3.1	Selecting a suitable BaseUnit	26
3.1.1	Digital, fail-safe, communication, technology or analog modules without temperature measurement	29
3.1.2	Analog modules with temperature measurement	30
3.2	Hardware configuration.....	31
3.3	Forming potential groups	32
3.3.1	Basics.....	32
3.3.2	Forming potential groups with AC I/O modules	35
3.3.3	Forming potential groups with fail-safe modules	36
3.4	Configuration examples for potential groups	37
4	Installation	39
4.1	Basics.....	39
4.2	Mounting the CPU/interface module	42
4.3	Installing the CM DP communication module.....	44
4.4	Installing BaseUnits	45
4.5	Installing the server module.....	48
5	Wiring	49
5.1	Rules and regulations for operation.....	49
5.2	Additional rules and regulations for the operation of the ET 200SP with fail-safe modules	51
5.2.1	Safety extra-low voltage (SELV) for fail-safe modules	51
5.2.2	Requirements for sensors and actuators for fail-safe modules	52
5.2.3	Crosstalk of digital input/output signals	55
5.3	Operating the ET 200SP on grounded incoming supply	55
5.4	Electrical configuration of the ET 200SP	58
5.5	Wiring rules	60

5.6	Wiring BaseUnits.....	62
5.7	Connecting cable shields	64
5.8	Connecting the supply voltage to the CPU/interface module	66
5.9	Connecting interfaces for communication.....	68
5.9.1	Connecting PROFINET IO to the CPU/interface module via the bus adapter BA 2xRJ45	68
5.9.2	Connecting PROFINET IO to the CPU/interface module via the BA 2xFC BusAdapter	70
5.9.3	Connecting PROFINET IO to the CPU/interface module via BA 2xSCRJ BusAdapter.....	74
5.9.4	Connecting PROFINET IO to the interface module via the BA SCRJ/RJ45 BusAdapter.....	77
5.9.5	Connecting PROFINET IO to the interface module via the BA SCRJ/FC BusAdapter	79
5.9.6	Connecting PROFINET IO to the interface module via the BA 2xLC BusAdapter.....	81
5.9.7	Connecting PROFINET IO to the interface module via the BA LC/RJ45 BusAdapter	84
5.9.8	Connecting PROFINET IO to interface module via BA LC/FC BusAdapter	86
5.9.9	Connecting PROFINET IO (port P3) to the CPU	87
5.9.10	Connecting the PROFIBUS DP interface to the interface module/communications module CM DP.....	89
5.10	Plugging in I/O modules and BU covers	90
5.11	Labeling ET 200SP	91
5.11.1	Factory markings.....	91
5.11.2	Optional markings	93
5.11.3	Applying color identification labels	94
5.11.4	Applying labeling strips	96
5.11.5	Applying reference identification labels	96
6	Configuring	97
6.1	Configuring ET 200SP	97
6.2	Configuring the CPU	100
6.2.1	Reading out the configuration	100
6.2.2	Addressing	102
6.2.3	Process images and process image partitions	104
6.2.3.1	Process image - overview.....	104
6.2.3.2	Automatically updating process image partitions.....	105
6.2.3.3	Update process image partitions in the user program	105
6.2.4	Backing up and restoring the CPU configuration.....	106
6.2.4.1	Overview	106
6.2.4.2	Backup from online device.....	108
6.2.4.3	Upload from device (software).....	111
6.2.4.4	Upload device as new station	113
6.2.4.5	Snapshot of the monitor values	115
6.2.4.6	Overwrite actual values of a block with snapshot values	117
6.3	Configuring the interface module.....	119
6.4	Assignment of the F-destination address for fail-safe modules.....	119
7	Basics of program execution	120
7.1	Events and OBs	120
7.2	CPU overload behavior.....	123
7.3	Asynchronous instructions	124

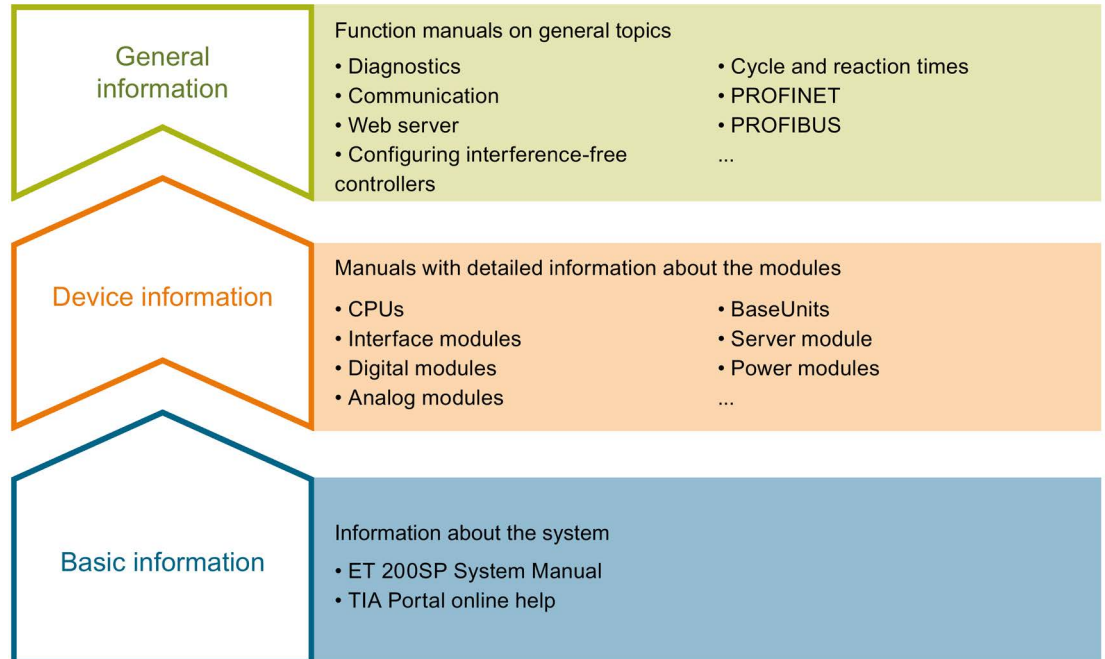
8	Protection	133
8.1	Overview of the protective functions of the CPU	133
8.2	Configuring access protection for the CPU.....	133
8.3	Using the user program to set additional access protection.....	136
8.4	Know-how protection	137
8.5	Copy protection.....	140
9	Configuration control (option handling)	142
9.1	Configuring.....	145
9.2	Creating the control data record	147
9.2.1	Introduction	147
9.2.2	Control data record for an ET 200SP CPU.....	149
9.2.3	Control data record for an interface module	151
9.2.4	Feedback data record for interface modules	155
9.2.5	Data records and functions.....	157
9.3	Transferring control data record in the startup program of the CPU	158
9.4	Behavior during operation.....	162
9.5	Examples of configuration control.....	163
10	Commissioning	168
10.1	Overview	168
10.2	Commissioning the ET 200SP for PROFINET IO	170
10.2.1	ET 200SP CPU as an IO controller	170
10.2.2	ET 200SP CPU as an I-device	172
10.2.3	ET 200SP as an IO device	174
10.3	Commissioning the ET 200SP on PROFIBUS DP	175
10.3.1	ET 200SP as a DP master.....	175
10.3.2	ET 200SP as I-slave	177
10.3.3	ET 200SP as a DP slave	179
10.4	Startup of the ET 200SP with empty slots	180
10.5	Removing/inserting a SIMATIC memory card on the CPU.....	180
10.6	Operating modes of the CPU.....	182
10.6.1	STARTUP mode	182
10.6.2	STOP mode	185
10.6.3	RUN mode	185
10.6.4	Operating mode transitions.....	186
10.7	CPU memory reset	187
10.7.1	Automatic memory reset.....	188
10.7.2	Manual memory reset	189
10.8	Reassigning parameters during operation.....	190
10.9	Identification and maintenance data	191
10.9.1	Reading out and entering I&M data.....	191
10.9.2	Data record structure for I&M data	193
10.10	Shared commissioning of projects.....	195

11	SIMATIC memory card	196
11.1	SIMATIC memory card - overview	196
11.2	Setting the card type	201
11.3	Data transfer with SIMATIC memory cards	202
12	Maintenance	203
12.1	Removing and inserting I/O modules.....	203
12.2	Changing the type of an I/O module	206
12.3	Replacing an I/O module	208
12.4	Replacing the terminal box on the BaseUnit.....	209
12.5	Firmware update	211
12.6	Resetting CPU/interface module (PROFINET) to factory settings	217
12.6.1	Resetting the CPU to factory settings.....	217
12.6.2	Resetting interface module (PROFINET IO) to factory settings	219
12.6.3	Resetting the interface module (PROFINET IO) to factory settings with a RESET button	220
12.7	Fault reactions with fail-safe modules.....	222
13	Test functions and eliminating problems	224
13.1	Test functions.....	224
13.2	Reading out/saving service data	227
14	Technical specifications	229
14.1	Standards and approvals	230
14.2	Electromagnetic compatibility	235
14.3	Electromagnetic compatibility of fail-safe modules	237
14.4	Shipping and storage conditions.....	239
14.5	Mechanical and climatic environmental conditions.....	239
14.6	Information on insulation, protection class, degree of protection and rated voltage	241
14.7	Use of the ET 200SP in zone 2 potentially explosive atmospheres	242
A	Dimension drawings	243
A.1	Shield connector	243
A.2	Labeling strip.....	243
A.3	Reference identification labels	244
B	Accessories/spare parts	245
B.1	Lightning protection and overvoltage protection for fail-safe modules	248
C	Calculating the leakage resistance	249
D	Service & Support	251
	Glossary	254
	Index	268

Guide to documentation

The documentation for the SIMATIC ET 200SP distributed I/O system is arranged into three areas.

This arrangement enables you to access the specific content you require.



Basic information

The system manual describes in detail the configuration, installation, wiring and commissioning of the SIMATIC ET 200SP. distributed I/O system. The STEP 7 online help supports you in the configuration and programming.

Device information

Product manuals contain a compact description of the module-specific information, such as properties, terminal diagrams, characteristics and technical specifications.

General information

The function manuals contain detailed descriptions on general topics regarding the SIMATIC ET 200SP distributed I/O system, e.g. diagnostics, communication, Web server, designing interference-free controllers.

You can download the documentation free of charge from the Internet (<http://w3.siemens.com/mcims/industrial-automation-systems-simatic/en/manual-overview/tech-doc-et200/Pages/Default.aspx>).

Changes and supplements to the manuals are documented in a Product Information.

Manual Collection ET 200SP

The Manual Collection contains the complete documentation on the SIMATIC ET 200SP distributed I/O system gathered together in one file.

You can find the Manual Collection on the Internet (<http://support.automation.siemens.com/WW/view/en/84133942>).

My Documentation Manager

The My Documentation Manager is used to combine entire manuals or only parts of these to your own manual.

You can export the manual as PDF file or in a format that can be edited later.

You can find the My Documentation Manager on the Internet (<http://support.industry.siemens.com/My/ww/en/documentation>).

Application examples

Applications examples support you with various tools and examples for solving your automation tasks. Solutions are shown in interplay with multiple components in the system - separated from the focus in individual products.

You can find application examples on the Internet (<http://support.industry.siemens.com/cs/ww/en/ps/ae>).

CAX Download Manager

The CAX Download Manager is used to access the current product data for your CAX or CAE systems.

You configure your own download package with a few clicks.

In doing so you can select:

- Product images, 2D dimension drawings, 3D models, internal circuit diagrams, EPLAN macro files
- Manuals, characteristics, operating manuals, certificates
- Product master data

You can find the CAX Download Manager on the Internet (<http://support.industry.siemens.com/my/ww/en/CAXOnline>).

TIA Selection Tool

With the TIA Selection Tool, you can select, configure and order devices for Totally Integrated Automation (TIA).

This tool is the successor of the SIMATIC Selection Tool and combines the known configurators for automation technology into one tool.

With the TIA Selection Tool, you can generate a complete order list from your product selection or product configuration.

You can find the TIA Selection Tool on the Internet (<http://w3.siemens.com/mcms/topics/en/simatic/tia-selection-tool>).

System overview

2.1 What is the SIMATIC ET 200SP distributed I/O system?

SIMATIC ET 200SP

SIMATIC ET 200SP is a scalable and highly flexible distributed I/O system for connecting process signals to a higher-level controller via a fieldbus.

Customer benefits of the system

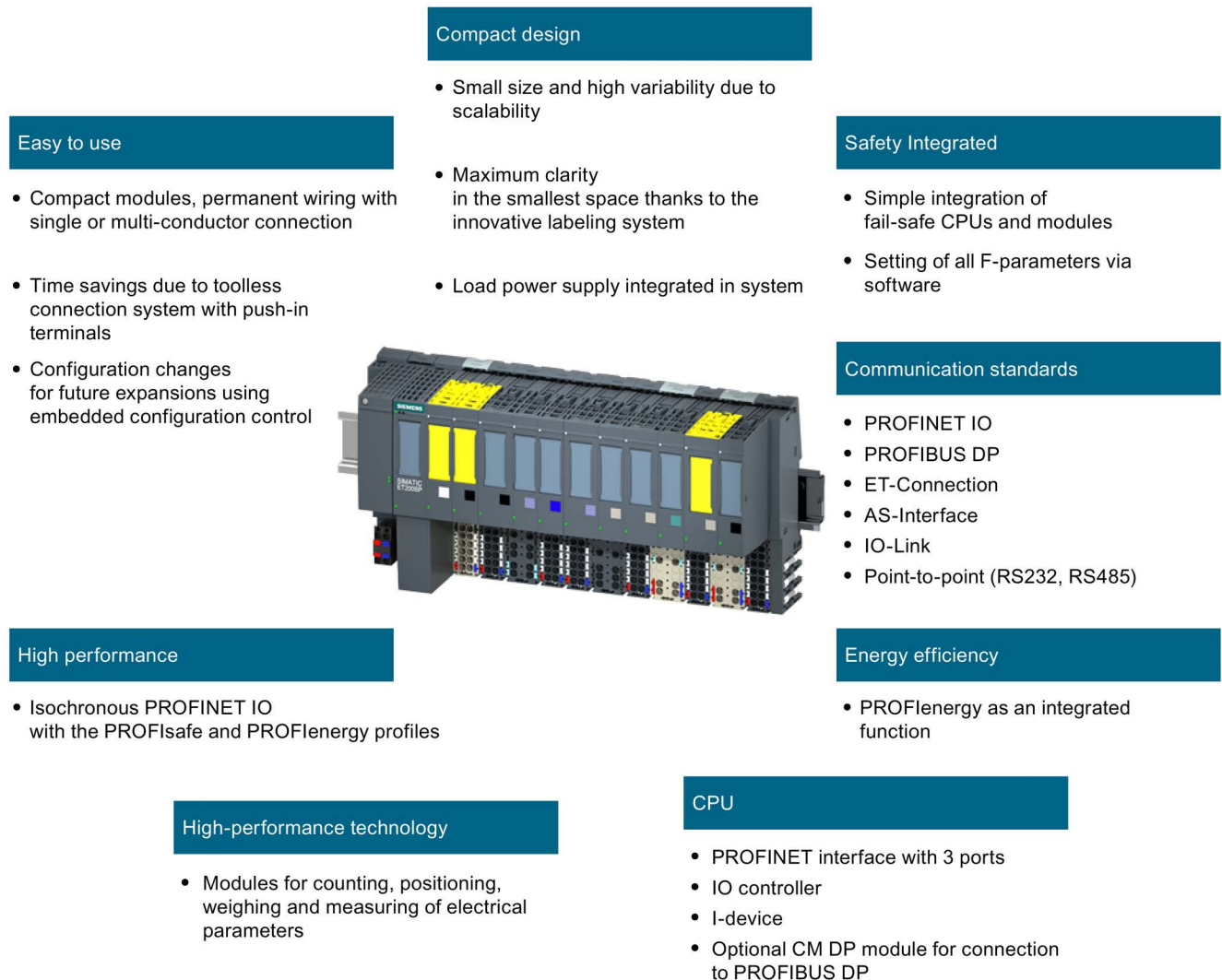


Figure 2-1 SIMATIC ET 200SP distributed I/O system - Customer benefits

2.1 What is the SIMATIC ET 200SP distributed I/O system?

Area of application

Thanks to its multifunctionality, the SIMATIC ET 200SP distributed I/O system is suitable for a wide range of applications. Its scalable design allows you to tailor your configuration to local requirements. Different CPUs/interface modules are available for connection to PROFINET IO or PROFIBUS DP.

SIMATIC ET 200SP with CPU allows intelligent pre-processing to relieve the higher-level controller. The CPU can also be used as standalone device.

By using fail-safe CPUs, you can implement applications for safety engineering. Configuration and programming of your safety program takes place the same way as for standard CPUs.

A wide range of I/O modules rounds off the product range.

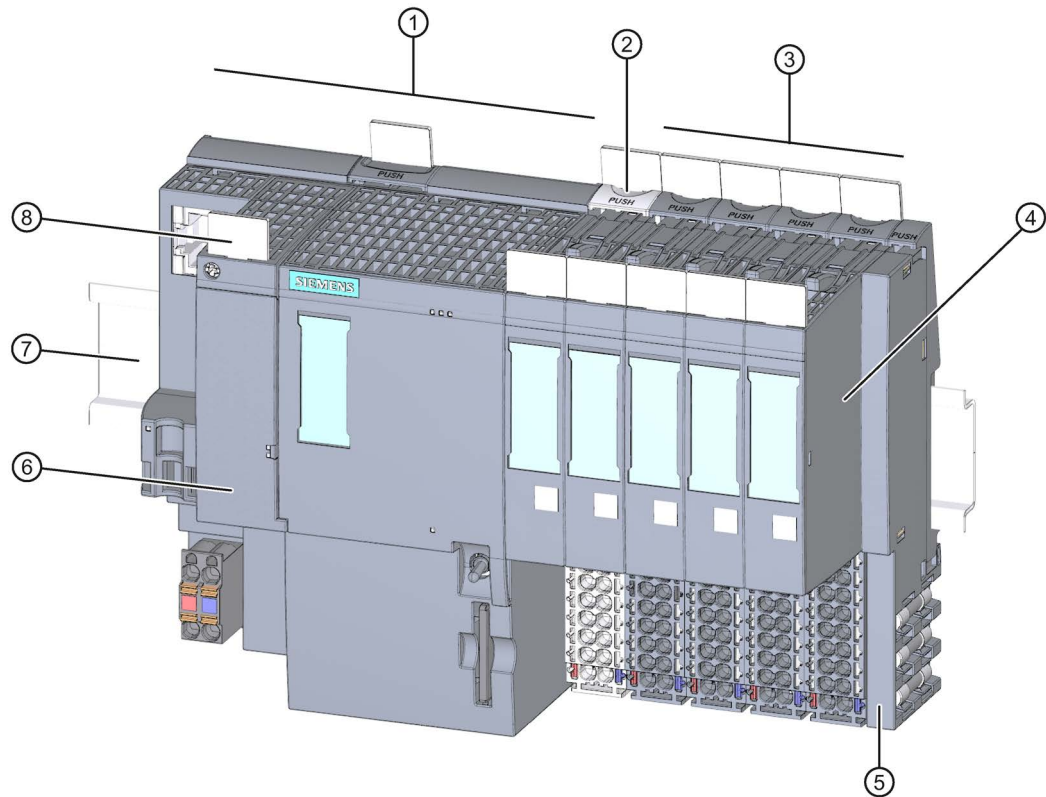
SIMATIC ET 200SP is designed with degree of protection IP20 and is intended for installation in a control cabinet.

Configuration

The SIMATIC ET 200SP distributed I/O system is installed on a mounting rail. It consists of:

- CPU/interface module
- Up to 64 I/O modules which can be plugged into BaseUnits in any combination
- A server module that completes the configuration of the ET 200SP.

Configuration example



- ① CPU/interface module
- ② Light-colored BaseUnit BU..D with infeed of supply voltage
- ③ Dark-colored BaseUnits BU..B for extending the potential group
- ④ I/O module
- ⑤ Server module (included in the scope of supply of the CPU/interface module)
- ⑥ BusAdapter
- ⑦ Mounting rail
- ⑧ Reference identification label

Figure 2-2 Configuration example of the ET 200SP

2.2 What are fail-safe automation systems and fail-safe modules?

Fail-safe automation systems

Fail-safe automation systems (F-systems) are used in systems with higher safety requirements. F-systems control processes and ensure that they are in a safe state immediately after shutdown. In other words, F-systems control processes in which an immediate shutdown does not endanger persons or the environment.

Safety Integrated

Safety Integrated is the integrated safety concept for automation and drive technology from Siemens.

Proven technologies and systems from automation technology are used for safety systems. Safety Integrated includes the complete safety sequence, ranging from sensor, actuator and fail-safe modules right through to the controller, including safety-related communication via standard fieldbuses. Drives and controllers handle safety tasks in addition to their actual functions.

Fail-safe modules

The key difference between fail-safe modules (F-modules) and standard modules is that they have an internal two-channel design. This means the two integrated processors monitor each other, automatically test the input and output circuits, and switch the fail-safe module to a safe state in the event of a fault.

The F-CPU communicates with a fail-safe module via the safety-related PROFIsafe bus profile.

Area of application of ET 200SP with fail-safe I/O modules

By using the ET 200SP distributed I/O system with fail-safe I/O modules, you are replacing conventional safety engineering configurations. This includes the replacement of switching devices for emergency STOP, protective door monitors, two-hand operation, etc.

2.3 How are SIMATIC Safety F-systems structured with ET 200SP?

SIMATIC Safety F-system with ET 200SP

The figure below shows an example of a configuration for a SIMATIC Safety F-system with ET 200SP distributed I/O system and PROFINET IO. The PROFINET IO lines can be set up with copper cable, fiber-optic cable or WLAN.

Fail-safe I/O modules and non-fail-safe I/O modules can be combined in an ET 200SP configuration.

The fail-safe IO controller (F-CPU) exchanges safety-related and non-safety-related data with fail-safe and non-fail-safe ET 200SP modules.

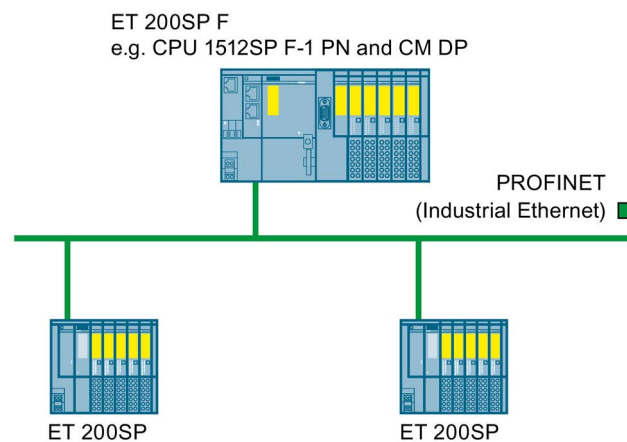


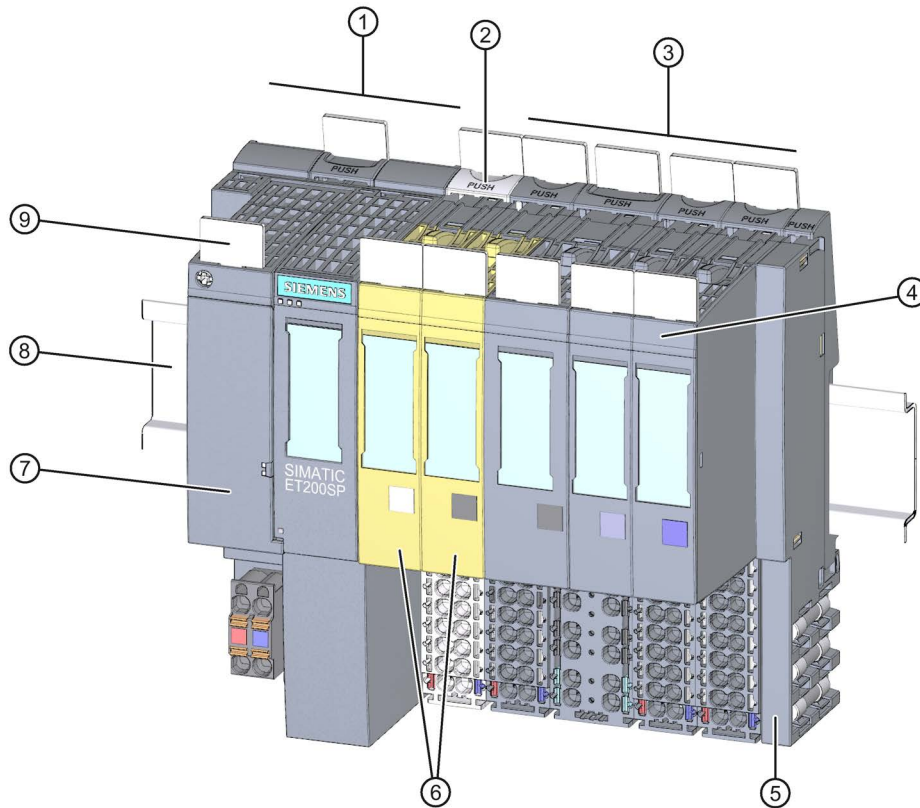
Figure 2-3 Fail-safe SIMATIC Safety automation system (sample configuration)

Fail-safe ET 200SP I/O modules

The following fail-safe I/O modules are available for the ET 200SP distributed I/O system:

- Fail-safe power modules are used to supply the potential group load voltage and for the safety-related tripping of the load voltage for non-fail-safe output modules.
- Fail-safe digital input modules detect the signal states of safety-related sensors and send the relevant safety frames to the F-CPU.
- Fail-safe digital output modules are suitable for safety-related shutdown procedures with short circuit and cross-circuit protection up to the actuator.

Example of a configuration with fail-safe I/O modules



- ① Interface module
- ② Light-colored BaseUnitBU..D with infeed of supply voltage
- ③ Dark-colored BaseUnitsBU..B for conducting the potential group further
- ④ I/O module
- ⑤ Server module (ships with the interface module)
- ⑥ Fail-safe I/O modules
- ⑦ BusAdapter
- ⑧ Mounting rail
- ⑨ Reference identification label

Figure 2-4 Example of a configuration of the ET 200SP with fail-safe I/O modules

Hardware and software requirements

ET 200SP fail-safe modules are supported by IM155-6PN ST interface modules as of firmware V1.1.1, IM155-6PN HF as of firmware V2.0 and IM155-6DP HF as of firmware V1.0.

You need the STEP 7 Safety Advanced option package V12 including HSP 54 or higher to configure and program the ET 200SP fail-safe modules with the SIMATIC Safety F-system.

You need the F-Configuration Pack V5.5 SP10 to configure and program the ET 200SP fail-safe modules with the Distributed Safety F-system.

You need the F-Configuration Pack V5.5 SP12 to configure and program the ET 200SP fail-safe modules with the Distributed Safety F/FH system.

Use in safety mode only

Safety mode is the F-I/O operating mode that allows safety-related communication using safety frames.

You can only use the ET 200SP fail-safe I/O modules in safety mode. They cannot be used in non-fail-safe mode.

Achievable safety classes

The fail-safe modules are equipped with integrated safety functions for safety mode.

You can achieve the safety classes of the table below:

- With the appropriate parameter assignment of the safety functions in STEP 7,
- With a specific combination of fail-safe and non-fail-safe I/O modules as well as
- With a special arrangement and wiring of the sensors and actuators

Table 2- 1 Safety classes that can be achieved with ET 200SP in safety mode

Safety class in safety mode		
According to IEC 61508	According to ISO 13849-1:2006	
SIL2	Category 3	(PL) Performance Level d
SIL3	Category 3	(PL) Performance Level e
SIL3	Category 4	(PL) Performance Level e


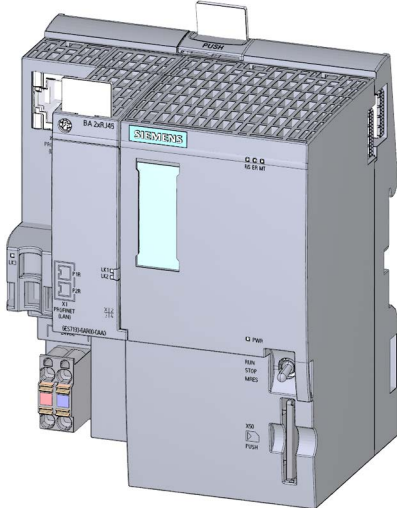
Additional information

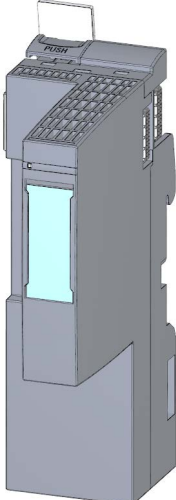
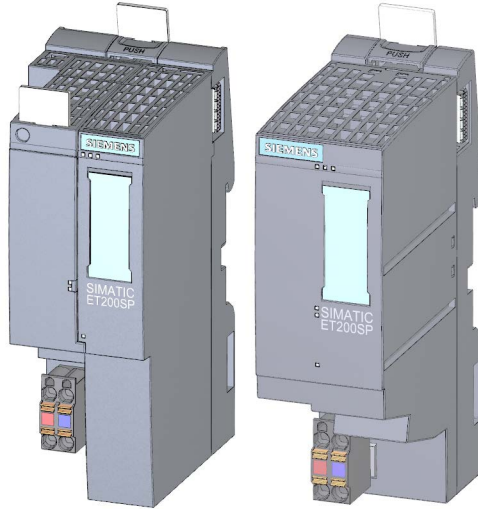
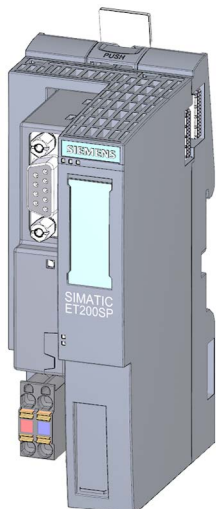
The applications and wiring for the particular safety class are described in the manuals of the fail-safe I/O modules.

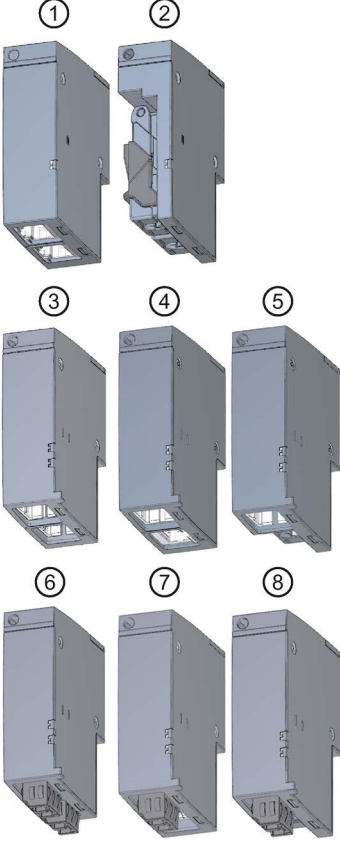
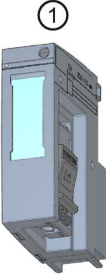
2.4 Components

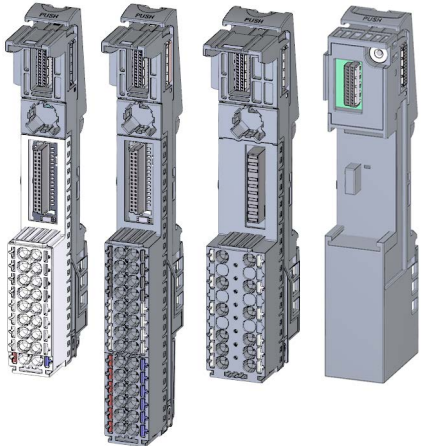
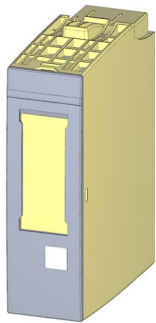
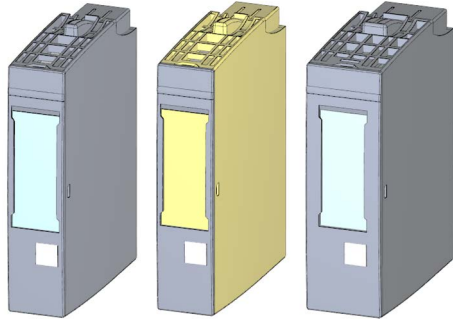
Basic components of the ET 200SP distributed I/O system

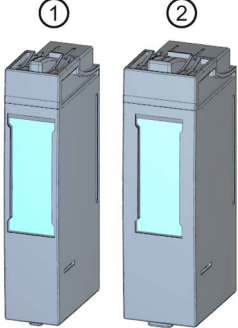

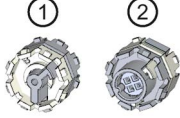
Table 2- 2 Basic components of the ET 200SP

Basic component	Function	Figure
Mounting rail in accordance with EN 60715	The mounting rail is the rack of the ET 200SP. The ET 200SP is installed on the mounting rail.	
CPU/Fail-safe CPU	<p>The (F) CPU:</p> <ul style="list-style-type: none"> • Runs the user program. The F-CPU also runs the safety program. • Can be used as an IO controller or I-device on PROFINET IO or as a standalone CPU • Links the ET 200SP to the IO devices or the IO controller • Exchanges data with the I/O modules via the backplane bus. <p>Additional CPU functions:</p> <ul style="list-style-type: none"> • Communication via PROFIBUS DP (the CPU can be used as a DP master or DP slave in combination with the CM DP communication module) • Integrated web server • Integrated technology • Integrated trace functionality • Integrated system diagnostics • Integrated safety • Safety mode (when using fail-safe CPUs) 	

Basic component	Function	Figure
<p>Communication module CM DP</p>	<p>The communication module CM DP</p> <ul style="list-style-type: none"> • Connects the CPU with PROFIBUS DP • The bus connection is an RS485 interface 	
<p>Interface module for PROFINET IO</p>	<p>The interface module:</p> <ul style="list-style-type: none"> • Can be used as IO device on PROFINET IO • Links the ET 200SP with the IO controller • Exchanges data with the I/O modules via the backplane bus. 	
<p>Interface module for PROFIBUS DP</p>	<p>The interface module:</p> <ul style="list-style-type: none"> • Can be used as DP slave on PROFIBUS DP • Links the ET 200SP with the DP master • Exchanges data with the I/O modules via the backplane bus. 	

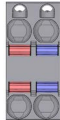

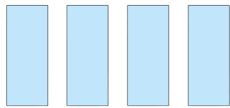

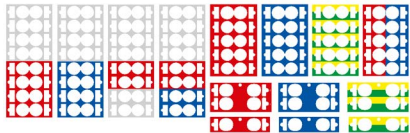
Basic component	Function	Figure
<p>BusAdapter</p>	<p>The BusAdapters allow free selection of the connection technology for PROFINET IO. The following versions are available for PROFINET CPU/interface modules:</p> <ul style="list-style-type: none"> • For standard RJ45 connector (BA 2×RJ45) ① • For direct connection of the bus cable (BA 2×FC) ② • For POF/PCF fiber-optic cable (BA 2xSCRJ) ③ • As media converter for POF/PCF fiber-optic cable ⇔ standard RJ45 plug (BA SCRJ/RJ45) ④ • As media converter for POF/PCF fiber-optic cable ⇔ direct connection of the bus cable (BA SCRJ/FC) ⑤ • For glass fiber-optic cable (BA 2xLC) ⑥ • As media converter for glass fiber-optic cable ⇔ standard RJ45 plug (BA LC/RJ45) ⑦ • As media converter for glass fiber-optic cable ⇔ direct connection of the bus cable (BA LC/FC) ⑧ 	
	<p>For mixed ET 200SP/ET 200AL configuration, you require the BusAdapter BA-Send 1xFC ① (plugged into the BaseUnit BU-Send). Connect the bus cable for ET-Connection to the BusAdapter BA-Send 1xFC.</p>	

Basic component	Function	Figure
BaseUnit	<p>The BaseUnits provide the electrical and mechanical connection of the ET 200SP modules. Insert the I/O modules onto the BaseUnits.</p> <p>Suitable BaseUnits are available in each case for the different requirements (see Selecting a suitable BaseUnit (Page 26))</p>	
Fail-safe power module	<p>The fail-safe power module allows the safety-related shutdown of digital output modules / fail-safe digital output modules.</p>	
I/O module / fail-safe I/O module	<p>The I/O module determines the function at the terminals. The controller detects the current process state via the connected sensors and actuators, and triggers the corresponding reactions. I/O modules are divided into the following module types:</p> <ul style="list-style-type: none"> • Digital input (DI, F-DI) • Digital output (DQ, F-DQ) • Analog input (AI, F-AI) • Analog output (AQ) • Technology module (TM) • Communication module (CM) 	

Basic component	Function	Figure
<p>BU cover</p>	<p>Insert the BU cover on the BaseUnits:</p> <ul style="list-style-type: none"> • Whose slots are not occupied by I/O modules • Whose slots have been reserved for future expansion (as empty slots). <p>You can keep a reference identification label for the planned I/O module inside the BU cover.</p> <p>There are two versions:</p> <ul style="list-style-type: none"> • For BaseUnits with a width of 15 mm ① • For BaseUnits with a width of 20 mm ② 	
<p>Server module</p>	<p>The server module completes the configuration of the ET 200SP. The server module includes holders for 3 spare fuses (5 × 20 mm).</p> <p>The server module ships with the CPU/interface module.</p>	
<p>Coding element</p>	<p>The coding element codes the I/O module with the BaseUnit.</p> <p>There are two versions:</p> <ul style="list-style-type: none"> • Mechanical coding element ①: Ensures the coding • Electronic coding element ②: This version also has an electronic, rewritable memory for module-specific configuration data (such as the F-destination address for fail-safe modules, parameter data for the IO link master). 	

Accessories of the ET 200SP distributed I/O system

Table 2- 3 Accessories of the ET 200SP

Accessories	Function	Figure
24 V DC connector	Applying the 24 V DC supply at the connector and connection with the IM.	
Shield connection	The shield connection allows the low-impedance contacting of cable shields with minimum installation times.	
Labeling strips	<p>Attach the labeling strips to the modules for system-specific labeling of the ET 200SP. The labeling strips can be printed.</p> <p>The labeling strips can be ordered as accessories (Page 245) on a roll for thermal transfer printers or as DIN A4 format sheets for laser printers.</p>	
Reference identification labels	<p>The labels enable the reference identification labeling of the ET 200SP components.</p> <p>The labels can be ordered on a mat for thermal transfer and inkjet printers as accessories (Page 245).</p>	
Color identification labels	The color identification labels are module-specific and can be ordered for the process terminals, AUX terminals and additional terminals as accessories (Page 245).	

Application planning

3.1 Selecting a suitable BaseUnit

Overview

The BaseUnits (BU) are classified according to different types. Each BaseUnit type is characterized by properties that match specific I/O modules (see the following tables and images).

The BU type can be recognized by the last two digits of the article number of an I/O module.

Note

A complete overview of the possible combinations between BaseUnits and I/O modules is available in the Product information on documentation of the ET 200SP distributed I/O system (<http://support.automation.siemens.com/WW/view/en/73021864>).

Table 3- 1 Selection of a suitable BaseUnit

Selecting a BaseUnit	I/O module (example)	Examples of suitable I/O modules for BU types	
		I/O module (example)	BaseUnit
BU type A0 See Digital, fail-safe, communication, technology or analog modules without temperature measurement (Page 29)	Digital, fail-safe, technology or communication module <ul style="list-style-type: none"> • 6ES7...A0 • 24 V DC • 15 mm wide 	DI 16×24VDC ST (6ES7131-6BF00-0 BA0)	BU15-P16+A0+2D (6ES7193-6BP00-0 DA0)
	Analog module with- out temperature measurement** <ul style="list-style-type: none"> • 6ES7...A1 • 24 V DC • 15 mm wide 	AI 4xU/I 2-wire ST (6ES7134-6HD00-0 BA1)	
BU type A1 See Analog modules with temperature measurement (Page 30)	Analog module with temperature measurement* <ul style="list-style-type: none"> • 6ES7...A1 • 24 V DC • 15 mm wide 	AI 4×RTD/TC 2-/3-/4-wire HF (6ES7134-6JD00-0 CA1)	BU15-P16+A0+2D/T(6ES7193-6BP00-0 DA1)

Selecting a BaseUnit	I/O module (example)	Examples of suitable I/O modules for BU types	
		I/O module (example)	BaseUnit
BU type B0 (BU..B, dark-colored BaseUnit)	Digital output module with relay <ul style="list-style-type: none"> 6ES7...B0 up to 230 V AC 20 mm wide 	RQ 4×120VDC-230VAC/5A NO ST (6ES7132-6HD00-0BB0)	BU20-P12+A4+0B (6ES7193-6BP20-0BB0)
BU type B1 (BU..B, dark-colored BaseUnit)	Digital modules <ul style="list-style-type: none"> 6ES7...B1 up to 230 V AC 20 mm wide 	DI 4×120..230VAC ST (6ES7131-6FD00-0BB1)	BU20-P12+A0+4B (6ES7193-6BP20-0BB1)
BU type C0 (BU..D, light-colored BaseUnit)	Fail-safe power module <ul style="list-style-type: none"> 6ES7...C0 24 V DC 20 mm wide CM AS-i Master ST/F- CM AS-i Safety ST <ul style="list-style-type: none"> 6ES7...C1 up to 30 V DC 20 mm wide 	CM AS-i Master ST (3RK7137-6SA00-0BC1)	BU20-P6+A2+4D (6ES7193-6BP20-0DC0)
BU type C1 (BU..B, dark-colored BaseUnit)	F-CM AS-i Safety ST <ul style="list-style-type: none"> 6ES7...C1 up to 30 V DC 20 mm wide 	F-CM AS-i Safety ST (3RK7136-6SC00-0BC1)	BU20-P6+A2+4B (6ES7193-6BP20-0BC1)
BU type D0	AI Energy Meter ST <ul style="list-style-type: none"> 6ES7...D0 up to 400 V AC 20 mm wide 	AI Energy Meter ST (6ES7134-6PA00-0BD0)	BU20-P12+A0+0B (6ES7193-6BP00-0BD0)
BU type F0	F-RQ 1×24VDC/24..230 VAC/5A <ul style="list-style-type: none"> 6ES7...F0 up to 230 V AC 20 mm wide 	F-RQ 1×24VDC/24..230VA C/5A (6ES7136-6RA00-0BF0)	BU20-P8+A4+0B (6E7193-6BP20-0BF0)

* For compensation of the reference junction temperature for thermocouples. The BU type A1 is required if measuring the reference junction temperature with an internal temperature sensor or if you need the 2×5 additional terminals.

** Analog modules with temperature measurement can be plugged on BU type A0.

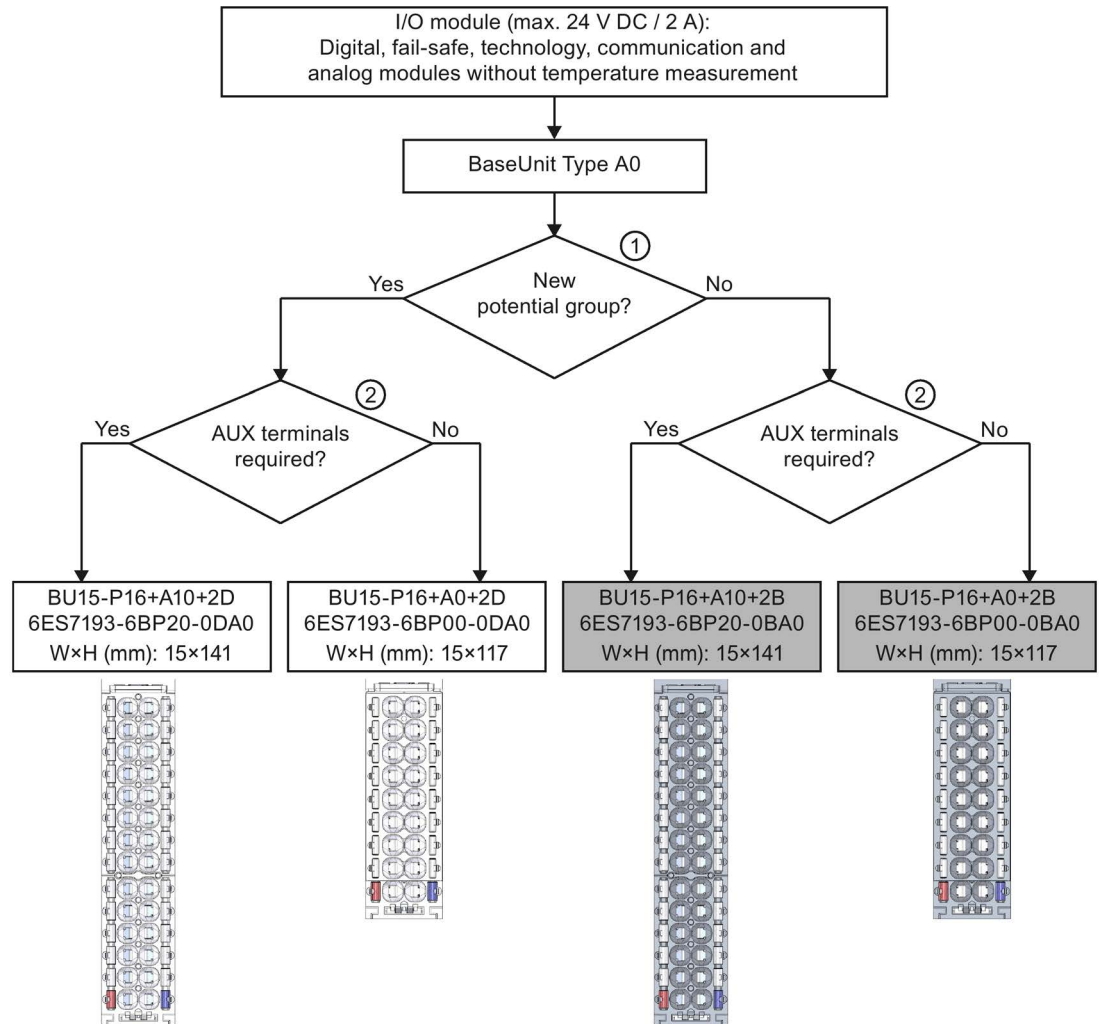
Additional information

Additional information on the functional assignment of the terminals and on the associated BaseUnits can be found in the

- Manual for the relevant I/O module (<http://support.automation.siemens.com/WW/view/en/55679691/133300>)
- BaseUnits (<http://support.automation.siemens.com/WW/view/en/59753521>) manual.

3.1.1 Digital, fail-safe, communication, technology or analog modules without temperature measurement

Selection of a suitable BaseUnit

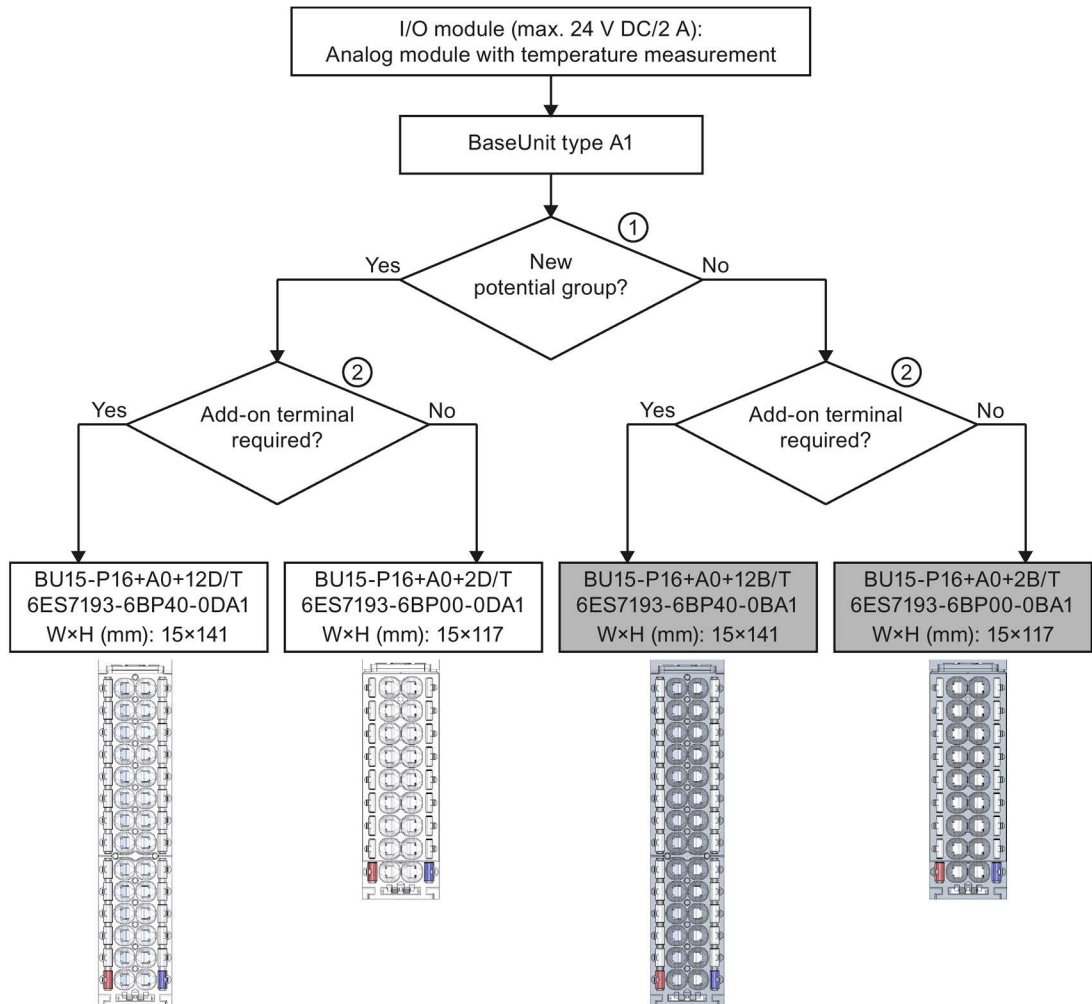


- ① Light-colored BaseUnit: Configuration of a new potential group, electrical isolation from adjacent module on the left. The first BaseUnit of the ET 200SP is usually a light-colored BaseUnit for feeding the supply voltage L+.
Exception: If you insert an AC I/O module or an AI Energy Meter as the first I/O module, the first BaseUnit in the ET 200SP configuration can be a dark-colored BaseUnit. The requirement is that you use a CPU or IM 155-6 (as of V3.0).
Dark-colored BaseUnit: Conduction of the internal power and AUX buses from the adjacent module on the left.
- ② AUX terminal: 10 internally bridged terminals for individual use up to 24 V DC/10 A or as protective conductors.
Example: Multiple cable connection for DI 8×24VDC ST

Figure 3-1 Digital, fail-safe, communication, technology or analog modules without temperature measurement

3.1.2 Analog modules with temperature measurement

Selection of a suitable BaseUnit



- ① Light-colored BaseUnit: Configuration of a new potential group, electrical isolation from adjacent module on the left. The first BaseUnit of the ET 200SP is usually a light-colored BaseUnit for feeding the supply voltage L+.
Dark-colored BaseUnit: Continuation of the internal power and AUX buses from the adjacent module on the left.
- ② Additional terminals: 2×5 internally bridged terminals for individual use up to 24 V DC/2 A
Example: Sensor supply for AI 4×U/I 2-wire ST

Figure 3-2 Analog modules with temperature measurement

3.2 Hardware configuration

Maximum mechanical configuration

As soon as **one** of the following rules applies, the maximum configuration of the ET 200SP has been reached:

Table 3- 2 Maximum mechanical configuration

Properties	Rule
Number of modules	<p>Maximum 12/32/64 I/O modules (depending on the CPU/interface module used, see CPU (http://support.automation.siemens.com/WW/view/en/90466439/133300) and Interface module (http://support.automation.siemens.com/WW/view/en/55683316/133300) Manual)</p> <p>The maximum configuration is reduced by 1 module for each 6 F-modules F-RQ 1x24 VDC/24..230VAC/5A (6ES7136-6RA00-0BF0).</p>
Backplane bus length of the ET 200SP	maximum 1 m mounting width (without CPU/interface module, including server module)

Maximum electrical configuration

The number of operable I/O modules of a potential group is limited by the

- Power consumption of the I/O modules
- Power consumption of the components supplied via these I/O modules

The maximum current-carrying capability of the terminals on the BaseUnit L+/ground is 10 A.

Address space

The address space depends on the CPU/interface module (see CPU (<http://support.automation.siemens.com/WW/view/en/90466439/133300>) Manual) and the interface module used (see Interface module (<http://support.automation.siemens.com/WW/view/en/55683316/133300>) Manual):

- For PROFINET IO: dependent on the IO controller/IO device used
- For PROFIBUS DP: dependent on the DP master used

3.3 Forming potential groups

3.3.1 Basics

Introduction

Potential groups for the ET 200SP distributed I/O system are formed by systematically arranging the BaseUnits.

Requirements

When forming potential groups, the ET 200SP distinguishes between two BaseUnits:

- BaseUnits BU...D (recognizable by the light-colored terminal box and the light-colored mounting rail release button):
 - Opening of a new potential group (power and AUX bus interrupted to the left)
 - Infeed of the supply voltage L+ up to an infeed current of 10 A
- BaseUnits BU...B (recognizable by the dark-colored terminal box and the dark-colored mounting rail release button):
 - Conduction of the potential group (power and AUX bus continued)
 - Pick up of the supply voltage L+ for external components or loop-through with a maximum total current of 10 A

Placing and connecting

Each BaseUnit BU...D that you install in the ET 200SP configuration opens a new potential group and supplies all subsequent I/O modules (on BaseUnits BU...B) with the necessary supply voltage. The first 24 V DC I/O module to the right of the CPU/interface module must be installed on a light-colored BaseUnit BU...D. Exception: If you insert an AC I/O module or an AI Energy Meter as the first I/O module, the first BaseUnit in the ET 200SP configuration can be a dark-colored BaseUnit. The requirement is that you use a CPU or IM 155-6 (as of V3.0).

If you want to place another BaseUnit BU...D after a BaseUnit BU...B, disconnect the power and AUX buses and open a new potential group at the same time. This allows individual grouping of the supply voltages.

AUX bus (AUX(iliary) bus)

BaseUnits with additional AUX terminals (e.g. BU15-P16+A10+2D) enable the additional connection of a potential (up to the maximum supply voltage of the module), which is applied via the AUX bus.

The AUX bus can be used individually:

- As PE bar (the requirements according to EN 60998-1 apply). To comply with this standard, a maximum of 8 I/O modules may be plugged into the corresponding potential group.
- For additionally required voltage

NOTICE

AUX bus as PE bar

If you use an AUX bus as a protective conductor bar, attach the yellow-green color identification labels to the AUX terminals, and establish a functional connection to the central protective conductor connection.

If you stop using the AUX bus as a protective conductor bar, make sure you remove the yellow-green color identification labels and remove the connection to the central protective conductor connection again.

The AUX bus is designed as follows:

- Maximum current-carrying capacity (at 60 °C ambient temperature): 10 A
- Permitted voltage: depending on the BaseUnit type (see BaseUnit manual (<http://support.automation.siemens.com/WWW/view/en/59753521>))

Self-assembling voltage buses

You must feed the supply voltage L+ in via BaseUnit BU...D.

Each BaseUnit BU...B allows access to the supply voltage L+ via terminals (red/blue).

Operating principle

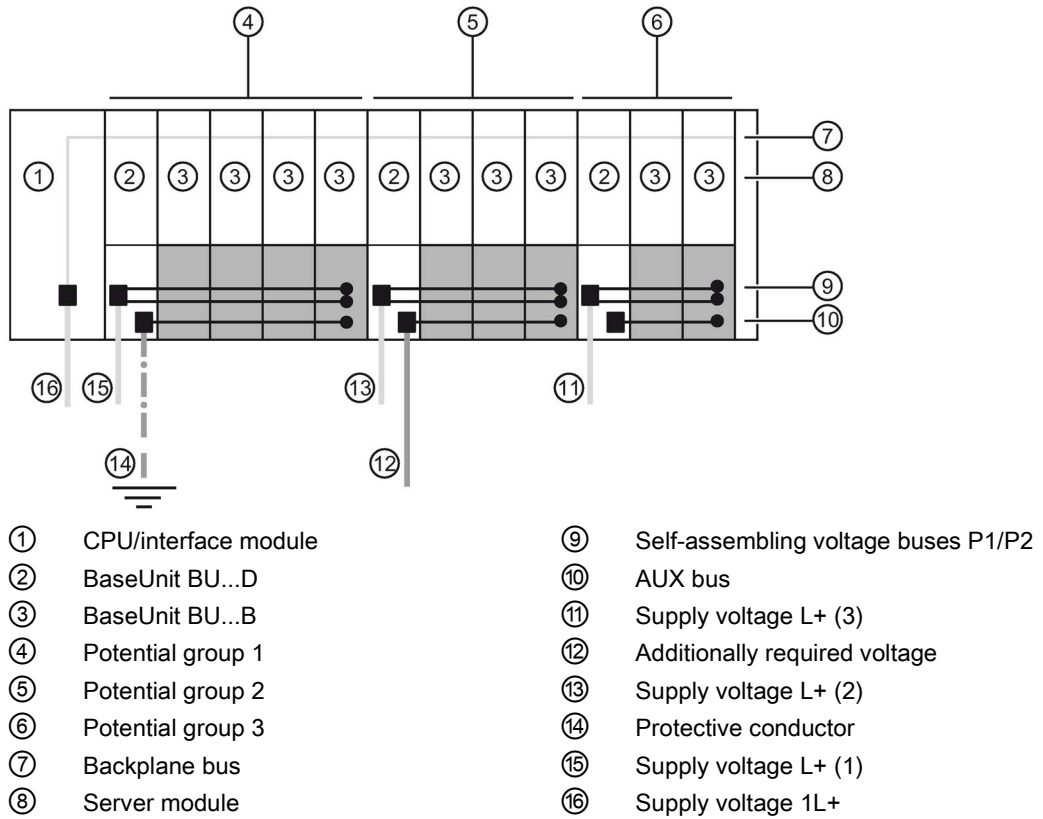


Figure 3-3 Placing the BaseUnits

Connecting different potentials to the AUX bus

Note

If you apply different potentials to the power or AUX bus within an ET 200SP station, you need to separate the potential groups with a BaseUnit BU...D.

3.3.2 Forming potential groups with AC I/O modules

Introduction

The AC I/O modules of the ET 200SP are required to connect sensors/actuators with alternating voltage 24 to 230 V AC.

Requirements

BaseUnits BU20-P12+A0+4B (BU type B1) and

- DI 4x120..230VAC ST digital input module
- DQ 4x24..230VAC/2A ST digital output module

Operating principle

Connect the required alternating voltage for the AC I/O modules directly at the BaseUnits BU20-P12+A0+4B (terminals 1L, 2L/1N, 2N). Insert the AC I/O modules on the BaseUnits.

Note

Placing the BaseUnits for AC I/O modules

If you insert an AC I/O module as the first I/O module, a BaseUnit BU20-P12+A0+4B can be the first BaseUnit to the right of the CPU/interface module in the ET 200SP configuration.

The requirement is that you use a CPU as of V3.0 or IM 155-6 (as of V3.0).

- The BaseUnits BU20-P12+A0+4B do not monitor the connected alternating voltage. Please note the information on limiting the overvoltage and power rating in the AC I/O module manuals.
- Remember to take the BaseUnit type into account during configuration.

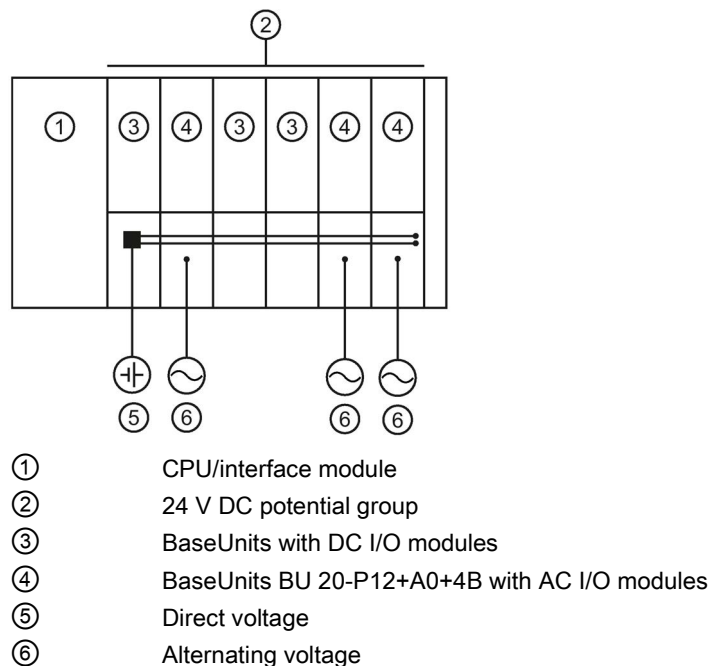


Figure 3-4 Placing the BaseUnits for the AC I/O modules

3.3.3 Forming potential groups with fail-safe modules

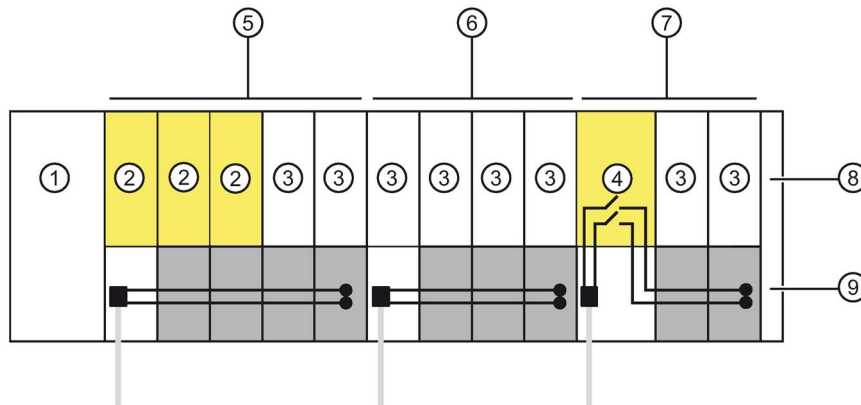
Introduction

ET 200SP distributed I/O systems can be configured using fail-safe and non-fail-safe modules. This chapter provides an example of a mixed configuration comprising fail-safe and non-fail-safe modules.

Example of an ET 200SP configuration with fail-safe and non-fail-safe modules

In principle, it is not necessary to operate fail-safe and non-fail-safe modules in separate potential groups. You can divide the modules into fail-safe and non-fail-safe potential groups and install them.

The figure below shows an example of a configuration with fail-safe and non-fail-safe modules within a single ET 200SP distributed I/O system.



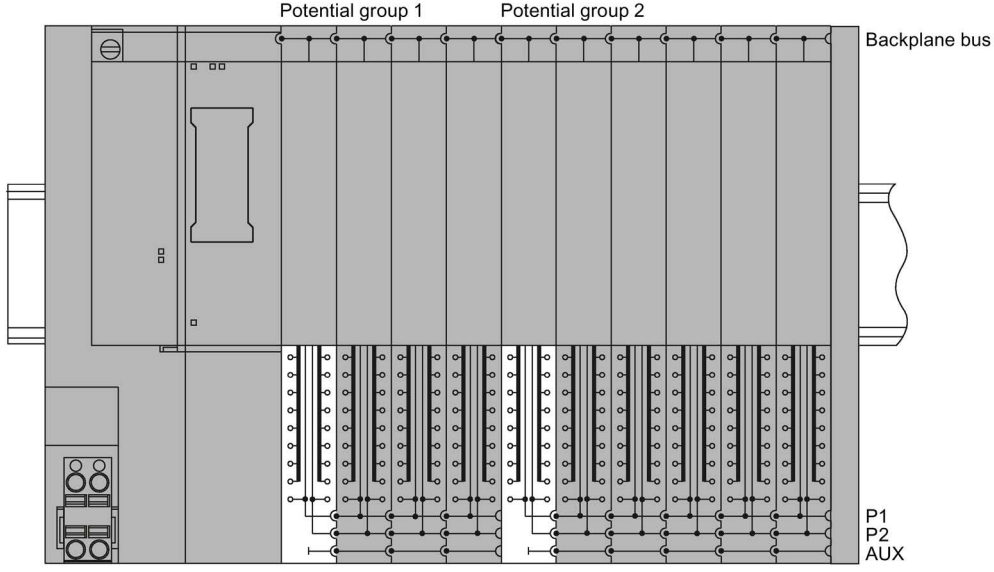
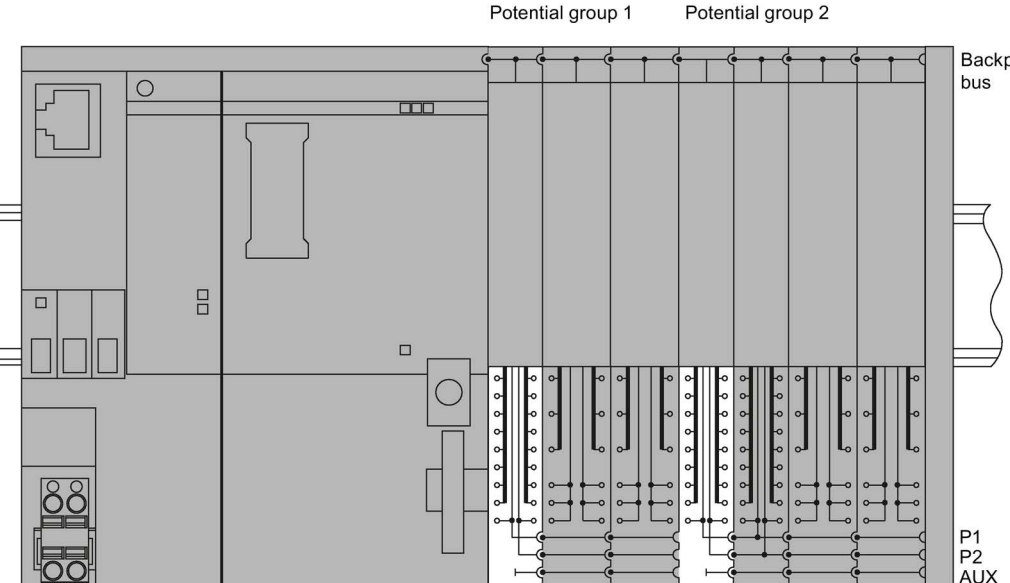
- ① IM 155-6 PN HF interface module
- ② F-module
- ③ Non-fail-safe module
- ④ Power module F-PM-E 24VDC/8A PPM ST
- ⑤ Mixed fail-safe and non-fail-safe potential group with BaseUnits BU15..D and BU15..B.
You achieve SIL3/Cat.4/PLe for the fail-safe modules.
- ⑥ Non-fail-safe potential group with BaseUnits BU15..D and BU15..B
- ⑦ Fail-safe potential group with BaseUnits BU20..D and BU15..B.
Through disconnection of the self-assembling voltage bus, and thus of the non-fail-safe modules, up to SIL2/Cat.3/PLd is possible.
- ⑧ Server module
- ⑨ Self-assembling voltage buses P1/P2

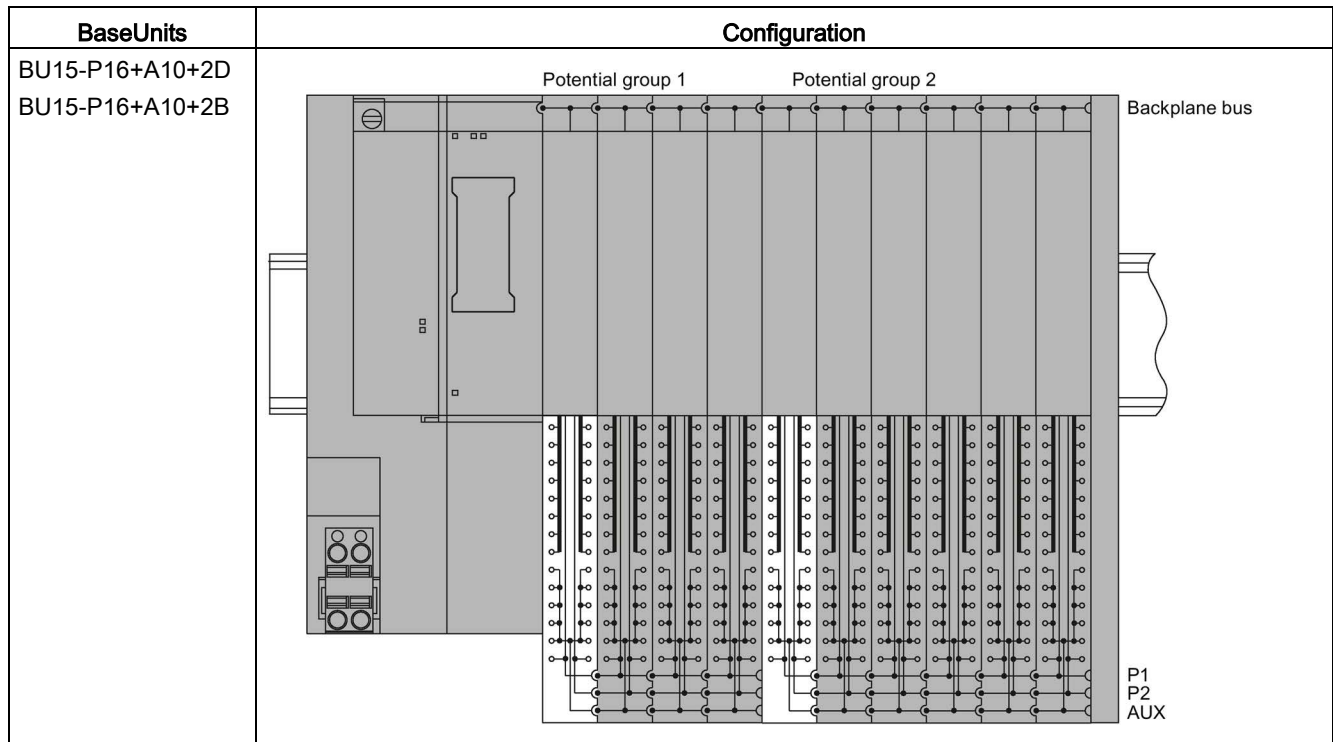
Figure 3-5 ET 200SP - example of a configuration with fail-safe modules

3.4 Configuration examples for potential groups

Configuration examples with BaseUnits

Table 3- 3 Configuration examples with BaseUnits

BaseUnits	Configuration
BU15-P16+A0+2D BU15-P16+A0+2B	 <p>The diagram shows a rack with two potential groups, labeled 'Potential group 1' and 'Potential group 2'. A 'Backplane bus' is located on the right side. The rack contains several BaseUnits. At the bottom, there are terminals labeled 'P1', 'P2', and 'AUX'. The diagram illustrates the internal wiring and connections between the units and the bus.</p>
BU15-P16+A0+2D BU15-P16+A0+2B BU20-P12+A0+0B	 <p>The diagram shows a rack configuration similar to the first one, but with an additional unit, 'BU20-P12+A0+0B', located in the lower section. It features two potential groups, 'Potential group 1' and 'Potential group 2', and a 'Backplane bus' on the right. The bottom terminals are labeled 'P1', 'P2', and 'AUX'. The diagram shows the internal wiring and connections for this more complex configuration.</p>



Installation

4.1 Basics

Introduction

All modules of the ET 200SP distributed I/O system are open equipment. This means that you may only install the ET 200SP distributed I/O system in housings, cabinets or electrical equipment rooms and in a dry environment. These housings, cabinets or electrical equipment rooms must only be accessible with a key or tool. Access must only be possible for personnel instructed or authorized to work with such equipment.

Installation location

Install the ET 200SP distributed I/O system into a suitable housing/control cabinet with sufficient mechanical strength, fire protection and at least IP54 degree of protection according to EN 60529, and take into consideration the ambient conditions for operating the devices.

Installation position

You can mount the ET 200SP distributed I/O system in any position. The preferred mounting position is horizontal mounting on a vertical wall. The ambient temperature may be restricted in certain installation positions. You will find more information in the section Mechanical and climatic environmental conditions (Page 239).

Mounting rail

Mount the ET 200SP distributed I/O system on a mounting rail in accordance with EN 60715 (35 × 7.5 mm or 35 × 15 mm).

You need to ground the mounting rail separately in the control cabinet. Exception: If you install the rail on grounded, zinc-plated mounting plates, there is no need to ground the rail separately.

Note

If the ET 200SP distributed I/O system is exposed to vibration and shock loads, both ends of the ET 200SP system assembly must be mechanically fixed to the mounting rail (e.g using 8WA1010-1PH01 ground terminals). This measure prevents the ET 200SP distributed I/O system from shifting to the side.

Note

If the ET 200SP distributed IO system is exposed to increased vibrations and shock, we recommend that you screw the mounting rail to the mounting surface at intervals of approx. 200 mm.

The following are suitable surfaces for the mounting rails:

- Steel strip in accordance with Appendix A of EN 60715 or
- Tinned steel strip. We recommend these in conjunction with the mounting rails in the section Accessories/spare parts (Page 245).

Note

If you use mounting rails from other manufacturers, make sure that they have the required properties for your ambient climatic conditions.

Minimum clearances

The figure below shows the minimum clearances you must observe when installing or dismantling the ET 200SP distributed I/O system.

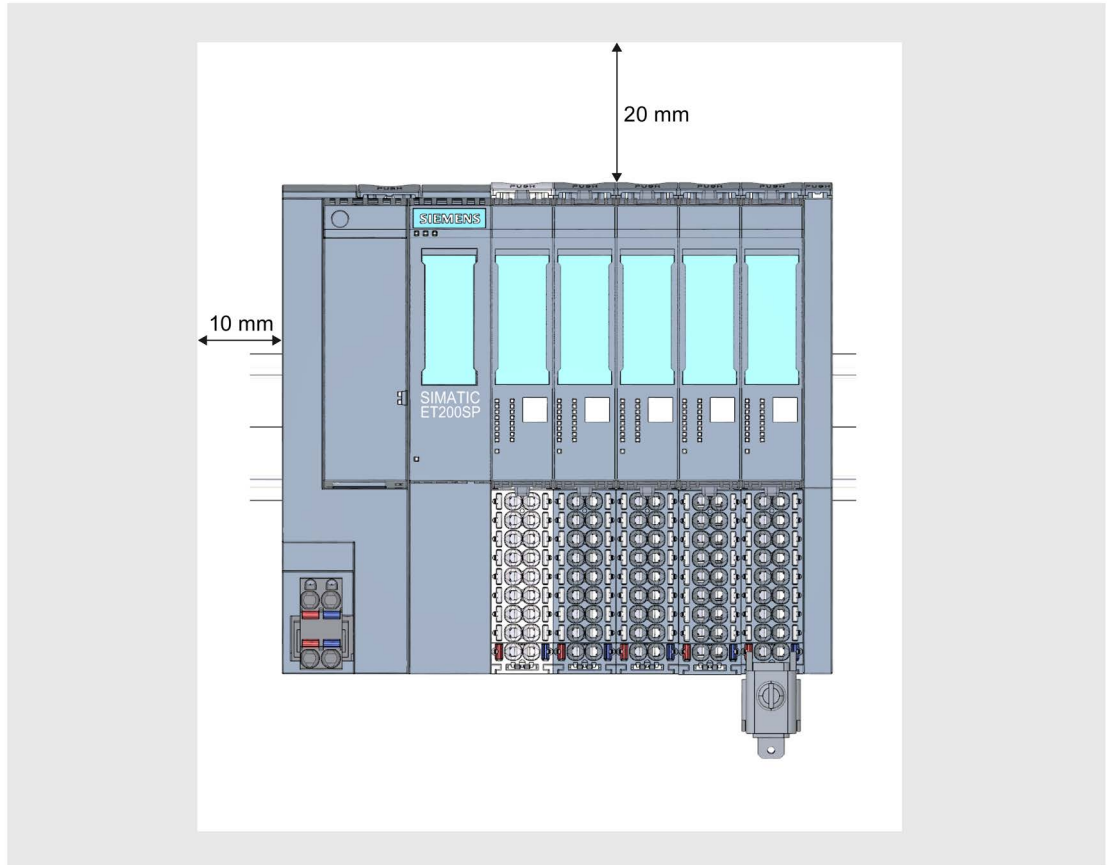


Figure 4-1 Minimum clearances

Installation rules


Observe the following rules:

- Installation starts on the left-hand side with the CPU/interface module.
- After the CPU/interface module or at the start of each potential group, a light-colored BaseUnit BU..D is installed with incoming supply voltage L+.
If you insert an AC I/O module or an AI Energy Meter as the first I/O module, the first BaseUnit in the ET 200SP distributed I/O system configuration can be a dark-colored BaseUnit. The requirement is that you use a CPU or IM 155-6 (as of V3.0).
- BaseUnits BU..B (with dark-colored terminal box) follow this.
- Suitable I/O modules can be connected to the BaseUnits. You will find suitable combinations of BaseUnits and I/O modules in the section Selecting a suitable BaseUnit (Page 26)
- The server module completes the configuration of the ET 200SP distributed I/O system.

Note

Mount the ET 200SP distributed I/O system only with disconnected supply voltage.

For fail-safe ET 200SP modules:

 WARNING
Protection from conductive contamination Taking into account the environmental conditions, the devices must be protected from conductive contamination. This can be achieved, for example, by installing the devices in a control cabinet with the appropriate degree of protection.

4.2 Mounting the CPU/interface module

Introduction

The CPU/interface module connects the ET 200SP distributed I/O system with the fieldbus and exchanges data between the higher-level controller and the I/O modules.

Requirement

The mounting rail is fitted.

Required tools

3 to 3.5 mm screwdriver (only for mounting and removing the BusAdapter)

Mounting the CPU/interface module

Watch the video sequence (<http://support.automation.siemens.com/WW/view/en/95886218>)

To install a CPU/interface module, follow these steps:

1. Install the CPU/interface module on the mounting rail.
2. Swivel the CPU/interface module towards the back until you hear the mounting rail release button click into place.

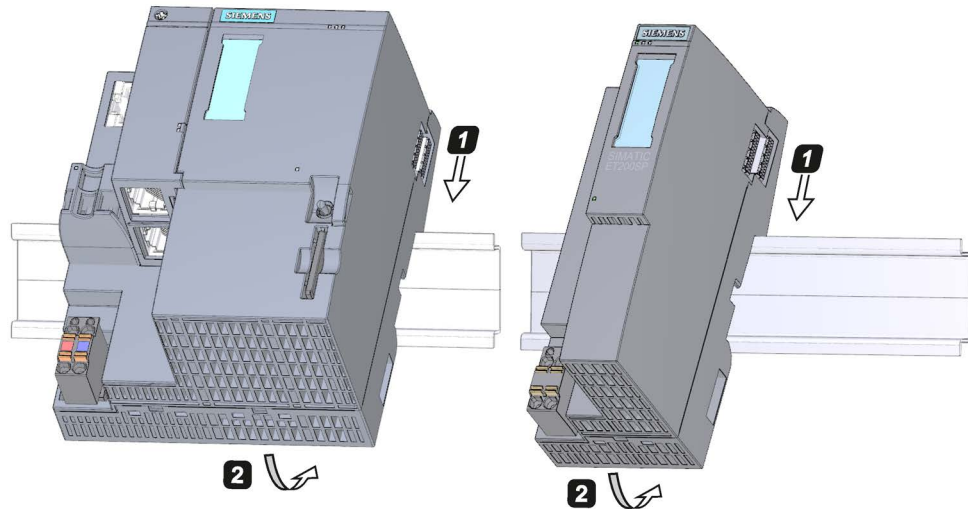


Figure 4-2 Mounting the CPU/interface module

Dismantling the CPU/interface module

The CPU/interface module is wired and BaseUnits are located to its right.

To remove the CPU/interface module, follow these steps:

1. Switch off the supply voltage on the CPU/interface module. Remove the 24 V DC connector from the CPU/interface module.
2. Press the mounting rail release button on the first BaseUnit. At the same time, shift the CPU/interface module parallel to the left until it detaches from the rest of the module group.

Note: The mounting rail release button is located above the CPU/interface module or BaseUnit.

3. While pressing the mounting rail release button on the CPU/interface module, swivel the CPU/interface module off of the mounting rail.

Note

It is not necessary to remove the BusAdapter from the CPU/interface module.

4.3 Installing the CM DP communication module

Introduction

You need the CM DP communication module to use the CPU with a DP master or DP slave.

Requirements

- The mounting rail is fitted.
- The CPU is installed.

Installing CM DP

To install the CM DP communication module, follow these steps:

1. Install the CM DP to the right of the CPU.
2. Swivel the CM DP towards the back until you hear the mounting rail release button click into place.
3. Slide the CM DP to the left until you hear it click into the CPU.

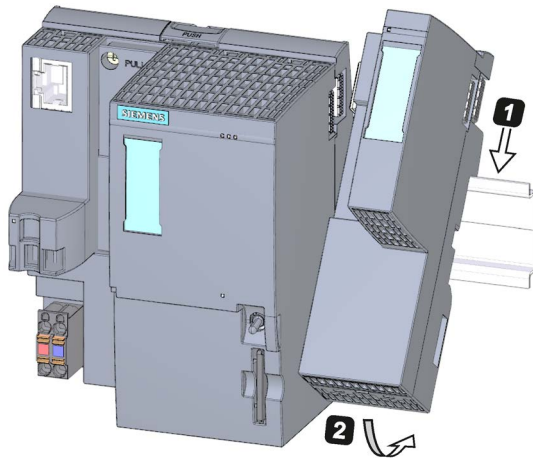


Figure 4-3 Installing CM DP

Removing a CM DP

The CPU and the CM DP are wired and BaseUnits are located to its right.

To remove the CM DP communication module, follow these steps:

1. Switch off the supply voltage on the CPU.
2. Press the mounting rail release button on the first BaseUnit and, at the same time, move the CPU and the CM DP parallel to the left until they detach from the rest of the module group (clearance about 16 mm).
3. Press the mounting rail release button on the CM DP and move it to the right until it detaches from the CPU (clearance about 8 mm).
4. While pressing the mounting rail release button on the CM DP, swivel the CM DP off of the mounting rail.

Note

It is not necessary to remove the bus connector from the CM DP unless you have to replace the CM DP.

4.4 Installing BaseUnits

Introduction

The BaseUnits are used for electromechanical connection between the individual ET 200SP components. They also provide terminals for connecting external sensors, actuators and other devices.

Requirements

The mounting rail is fitted.

Required tools

3 to 3.5 mm screwdriver (only for dismantling the terminal box and the encoding element)

Installing a BaseUnit

Watch the video sequence (<http://support.automation.siemens.com/WW/view/en/95886218>)

To install a BaseUnit, follow these steps:

1. Install the BaseUnit on the mounting rail.
2. Swivel the BaseUnit backwards until you hear it click into the mounting rail.
3. Slide the BaseUnit parallel to the left until you hear it click into the preceding CPU/interface module or BaseUnit.

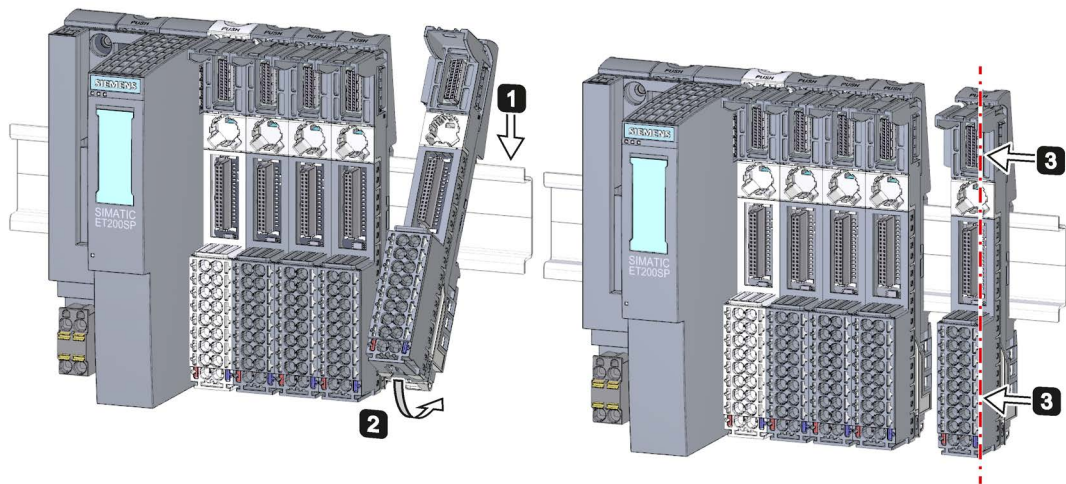


Figure 4-4 Installing a BaseUnit

Removing a BaseUnit

To remove a BaseUnit, follow these steps:

The BaseUnit is wired and there are other BaseUnits to its right and left.

To remove a specific BaseUnit, move the neighboring modules. As soon as you have created a clearance of about 8 mm from the neighboring BaseUnits, you can remove the BaseUnit.

Note

The terminal box can be replaced without removing the BaseUnit. Refer to section Replacing the terminal box on the BaseUnit (Page 209).

To remove a BaseUnit, follow these steps:

1. If present, turn off the supply voltage on the BaseUnit.
2. Loosen the wiring on the BaseUnit (with a 3 to 3.5 mm screwdriver).
3. **Removing (from the right):**

Press the mounting rail release button on the corresponding BaseUnit. Move the BaseUnit parallel to the right and swivel the BaseUnit off of the mounting rail while pressing the mounting rail release button.

Removing (from the left):

Press the mounting rail release button on the corresponding BaseUnit and on the BaseUnit to the right of this. Move the BaseUnit parallel to the left and swivel it out of the mounting rail while pressing the mounting rail release button.

Note: The mounting rail release button is located above the BaseUnit.

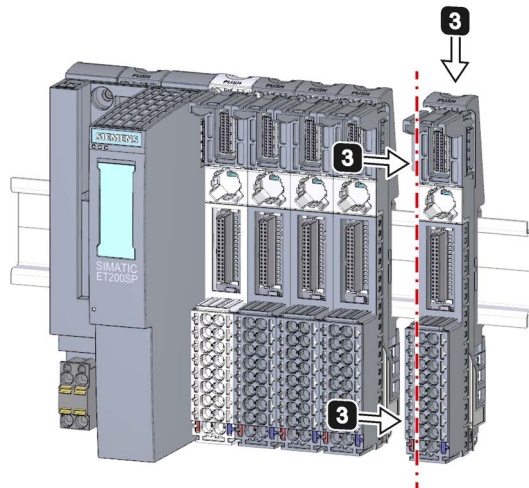


Figure 4-5 Removing the BaseUnit (removing from the right)

4.5 Installing the server module

Introduction

The server module on the far right of the assembly/line completes the ET 200SP distributed I/O system.

Requirement

The last BaseUnit is mounted.

Installing the server module

Watch the video sequence (<http://support.automation.siemens.com/WW/view/en/95886218>)

Proceed as follows to install a server module:

1. Install the server module on the mounting rail on the right next to the last BaseUnit.
2. Swivel the server module backwards on the mounting rail.
3. Move the server module parallel to the left until you hear it click into the last preceding BaseUnit.

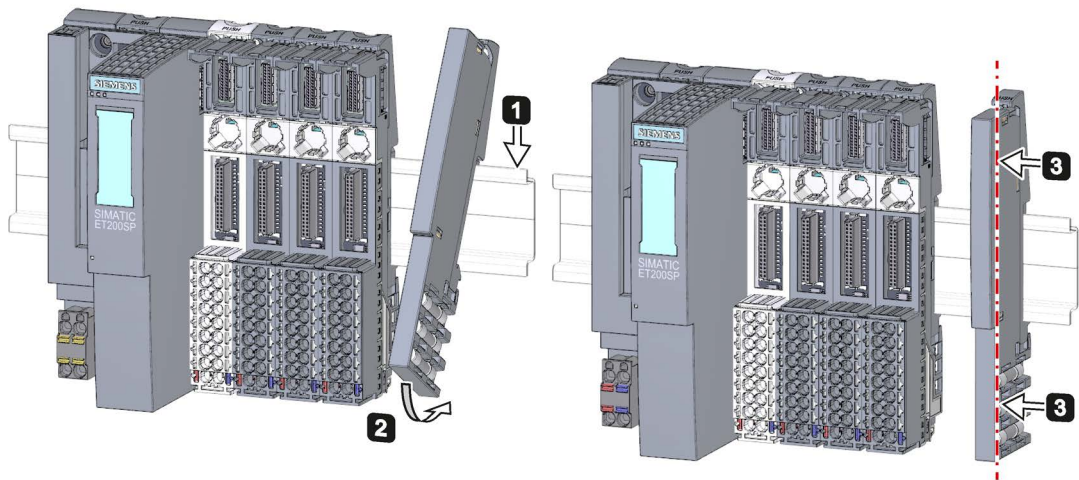


Figure 4-6 Installing the server module

Removing the server module

Proceed as follows to remove a server module:

1. Press the mounting rail release button on the server module.
2. Move the server module parallel to the right.
3. While pressing the mounting rail release button, swivel the server module off the mounting rail.

Wiring

5.1 Rules and regulations for operation

Introduction

When installing the ET 200SP distributed I/O system as part of a plant or system, special rules and regulations need to be adhered to depending on the area of application.

This section provides an overview of the most important rules that must be observed for the integration of the ET 200SP distributed I/O system in a plant or system.

Specific application

Adhere to the safety and accident prevention regulations applying to specific applications, for example machine protection guidelines.

EMERGENCY STOP devices

EMERGENCY STOP devices in accordance with IEC 60204 (corresponds to DIN VDE 0113) must remain effective in all operating modes of the plant or system.

Excluding hazardous plant states

Hazardous operating states must not occur when

- the plant starts up again after a voltage dip or voltage failure.
- the bus communication is resumed after a fault.

If necessary, EMERGENCY STOP must be forced!

An uncontrolled or undefined startup must not occur after the EMERGENCY STOP is unlocked.

Line voltage

Below, everything you need to consider in terms of line voltage is described (refer to section Information on insulation, protection class, degree of protection and rated voltage (Page 241)):

- For fixed plants or systems without an all-pole mains disconnection switch, a mains disconnection device (all-pole) must be available in the building installation.
- For load power supplies, the configured rated voltage range must correspond to the local line voltage.
- For all power circuits of the ET 200SP distributed I/O system, the fluctuation/deviation of the line voltage from the rated value must be within the permitted tolerance.

24 V DC supply

Below you will find a description of what you need to pay attention to with 24 V DC supply:

- For buildings: In the event of danger through overload, you must provide lightning protection measures for external lightning protection (e.g. lightning protection elements).
- For 24 V DC supply lines and signal lines: If there is a risk of overvoltages, you need to take precautions to ensure internal lightning protection (e.g. lightning protection elements, refer to section Accessories/spare parts (Page 245)).
- For 24 V DC supply: Make sure there is safe (electrical) isolation and separate cable routing or increased insulation of the low voltage (SELV/PELV) to electric circuits with dangerous potentials in accordance with IEC 60364-4-41.

Protection against outside electrical influences

Below is a description of what you must pay attention to in terms of protection against electrical impacts and/or faults:


- Make sure that the system for discharging electromagnetic interference is connected to a protective conductor with sufficient cross-section for all plants with an ET 200SP distributed I/O system.
- For supply, signal and bus lines, you must ensure that the laying of the lines and the installation is correct.
- For signal and bus lines, you must ensure that a wire/cable break or a cross-circuit does not lead to undefined states of the plant or system.


Reference

You can find more information in the Designing interference-free controllers (<http://support.automation.siemens.com/WW/view/en/59193566>) function manual.

5.2 Additional rules and regulations for the operation of the ET 200SP with fail-safe modules

5.2.1 Safety extra-low voltage (SELV) for fail-safe modules

 WARNING
<p>The fail-safe modules must be operated with safety extra low voltage (SELV, PELV). You can find more information on safety extra-low voltage in the data sheets, for example, of the applicable power supplies.</p> <p>The fail-safe modules work with a rated voltage of 24 V DC. The tolerance range is 19.2 V DC to 28.8 V DC.</p> <p>Within the overvoltage range from 32 V DC to 36 V DC, the F-modules react in a fail-safe manner and the inputs and outputs are passivated. For overvoltages greater than 36 V DC, the F-modules are permanently de-energized.</p> <p>Use a power supply unit that does not exceed $U_m = 36$ V DC even in the event of a fault. For more on this, refer to the information in the data sheet on overvoltage protection in the case of an internal error. Or implement appropriate measures to limit the voltage, e.g., use of an overvoltage protector.</p> <p>All system components that can supply electrical energy in any form whatsoever must fulfill this condition.</p> <p>Each additional circuit (24 V DC) used in the system must have a safety extra low voltage (SELV, PELV). Refer to the relevant data sheets or contact the manufacturer.</p> <p>Sensors and actuators with an external power supply can also be connected to F-modules. Make sure that power is supplied to these components from safety extra-low voltage as well. The process signal of a 24 V DC digital module may not exceed a fault voltage U_m in the event of a fault.</p>

 WARNING
<p>Even when a fault occurs, the permissible potential difference between the supply of the interface module (bus voltage) and the load voltage must not be exceeded.</p> <p>An external direct electrical connection is one way to meet this requirement. This also prevents potential differences from causing voltage additions at the individual voltage sources, which would cause the fault voltage U_m to be exceeded.</p>

Power supply requirements for compliance with NAMUR recommendations

Note

To ensure adherence to the NAMUR recommendation NE 21, IEC 61131-2 and EN 298, only use power packs/power supply units (230 V AC → 24 V DC) with a mains buffering time of at least **20 ms**. The latest up-to-date information on PS components is available on the Internet (<https://mall.industry.siemens.com>).

These requirements, of course, also apply to power packs/power supply units not constructed using ET 200SP / S7-300-/400-/1500 technology.

5.2.2 Requirements for sensors and actuators for fail-safe modules

General requirements for sensors and actuators

Note the following important warning regarding safety-related use of sensors and actuators:

WARNING

Note that instrumentation with sensors and actuators bears a considerable **safety responsibility**. Also bear in mind that sensors and actuators generally do not have proof-test intervals of 20 years as defined in IEC 61508:2010 without considerable loss of safety.

The probability of hazardous faults and the rate of hazardous faults of safety functions must comply with an SIL-defined high limit. A listing of values achieved by F-modules in the technical specifications of the F-modules is available under "Fail-safe performance characteristics".

To achieve the required safety class, suitably qualified sensors and actuators are necessary.

Additional sensor requirements

General rule: To achieve SIL3/Cat.3/PLe, a single-channel sensor is adequate. However, to achieve SIL3/Cat.3/PLe with a single-channel sensor, the sensor itself must be SIL3/Cat.3/PLe-capable; otherwise the sensor must be connected by two channels to achieve this safety level.

To achieve SIL3/Cat.4/PLe, sensors must be connected by two channels.

WARNING

In the case of fail-safe input modules, the value "0" is output to the F-CPU after detection of faults. You therefore need to make sure that the sensors are implemented in such a way as to ensure the reliable reaction of the safety program when the sensor is in the "0" state.

Example: In its safety program, an EMERGENCY-STOP sensor must achieve the shutdown of the relevant actuator when it is in the "0" state (EMERGENCY-STOP button pressed).

Duration requirements for sensor signals

WARNING

Observe the following requirements for sensor signals:

- To ensure the correct detection of the sensor signals via fail-safe modules with inputs, you need to make sure that the sensor signals are output for a minimum duration.
- For pulses to be detected with certainty, the time between two signal changes (pulse duration) must be greater than the PROFIsafe monitoring time.

Reliable detection by F-modules with inputs

The minimum duration of sensor signals for F-modules with inputs depends on the configured input delay, the parameters of the short circuit test of the sensor supplies, and the configured discrepancy behavior for 1oo2 evaluation. The signal must be greater than the maximum response time of the configured application. Information on calculating the maximum response time can be found in the section "Response times" of the relevant F-module.

The maximum permitted switching frequency of the sensor signals results from the minimum duration.

Additional requirements for actuators

The fail-safe output modules test the outputs at regular intervals. The F-module briefly switches off the activated outputs and, if necessary, switches on the deactivated outputs. You can assign the maximum duration of the test pulses (dark and light period) with parameters.

Fast reacting actuators may briefly drop out or be activated during the test. If your process does not tolerate this, set the pulse duration of the light or dark test correspondingly or use actuators that have sufficient lag.



WARNING

If the actuators switch voltages greater than 24 VDC (e.g., 230 VDC), the outputs of a fail-safe output module and the parts carrying a higher voltage must be electrically isolated (according to IEC 60664-1).

This is generally the case for relays and contactors. Particular attention must be paid to this with semiconductor switching devices.

Technical specifications of sensors and actuators

Refer to the manuals of the fail-safe modules for technical specifications to assist you in selecting sensors and actuators.

5.2.3 Crosstalk of digital input/output signals

When fail-safe digital output and input signals are in a single cable, F-DQ modules and F-PM-E modules may experience readback errors.

Cause: Capacitive crosstalk

During the bit pattern test of the outputs or the sensor supply of the inputs, the steep switching edge of the output drivers caused by the coupling capacitance of the line may result in crosstalk to other non-activated output or input channels. This may then lead to a response of the readback circuit in these channels. The module detects a cross circuit/short circuit and performs a safety-related shutdown.

Remedy:

- Separate cables for F-DI modules, F-DQ modules, and F-PM-E modules or non-fail-safe DQ modules
- Separate cables for F-DQ channel and F-DI channels for the F-PM-E module
- Coupling relay or diodes in the outputs
- Disable the sensor supply test if safety class requirements allow it.

Cause: magnetic crosstalk

Note that an inductive load connected to the F-DQ channels can induce coupling of a strong magnetic field.

Remedy:

- Separate the inductive loads spatially or shield against the magnetic field.
- Configure the readback time to 50 ms or higher.

5.3 Operating the ET 200SP on grounded incoming supply

Introduction

Below you will find information on the overall configuration of an ET 200SP distributed I/O system on a grounded incoming supply (e.g. TN-S network). The specific subjects discussed are:

- Disconnecting devices and short-circuit and overload protection according to IEC 60364 (corresponds to DIN VDE 0100) and IEC 60204 (corresponds to DIN VDE 0113)
- Load power supplies and load circuits.

Grounded incoming supply

In the case of grounded incoming supplies (TN-S system) the neutral conductor (N) and the protective conductor (PE) are each grounded. Both conductors form a part of the overvoltage concept. When a plant is in operation, the current flows across the neutral conductor. When a fault occurs, for example, a single ground fault between a live conductor and ground, the current flows through the protective conductor.

Safe electrical isolation (SELV/PELV in accordance with IEC 60364-4-41)

Load current / power supply modules with safe electrical isolation are required for the operation of the ET 200SP distributed I/O system. This protection is referred to as SELV (Safety Extra Low Voltage) / PELV (Protective Extra Low Voltage) according to IEC 60364-4-41.

Configuration of ET 200SP with ungrounded reference potential

To conduct interference currents, the reference potential of the CPU/interface module and the BaseUnits BU15...D is connected internally via an RC combination (IM/CPU: R = 10 MΩ / C = 100 nF, BU15...D: R = 10 MΩ / C = 4 nF) with the mounting rail (protective conductor).

- This configuration conducts high-frequency interference currents and prevents static charges.
- It is always possible to configure an ungrounded setup of the ET 200SP distributed I/O system as the ET 200SP distributed I/O system has no fixed ground connection. The power pack/power supply module for 24 V DC must also be ungrounded and electrically isolated.

If you want to configure the ET 200SP distributed I/O system with grounded reference potential, connect the 1M connection of the CPU/interface module electrically with the protective conductor.

Short-circuit / overload protection

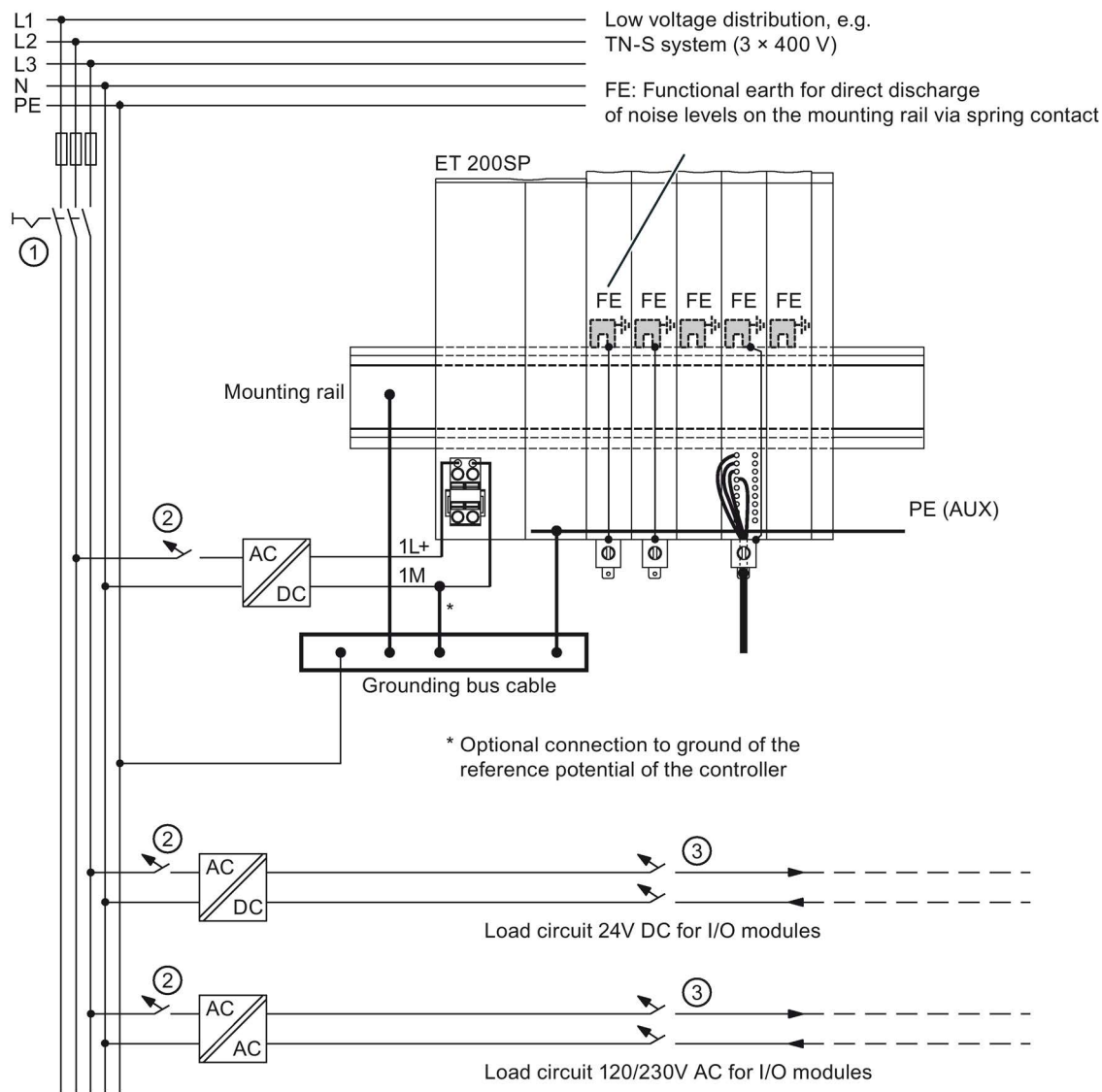
Various measures as protection against short-circuits and overloads are required for setting up a full installation. The type of components and the binding protective measures depend on which IEC (DIN VDE) regulation applies to your system configuration. The table refers to the figure below and compares the IEC (DIN VDE) regulations.

Table 5- 1 Components and protective measures

	Refer to figure	IEC 60364 (DIN VDE 0100)	IEC 60204 (DIN VDE 0113)
Disconnecting device for controller, sensors, and actuators	①	Main switch	Disconnecter
Short-circuit / overload protection: In groups for sensors and actuators	② ③	Single-pole protection of circuits	With grounded secondary circuit: single-pole protection otherwise: all-pole protection
Load current supply for AC load circuits with more than five items of electromagnetic equipment	②	Galvanic isolation by transformer recommended	Galvanic isolation by transformer recommended

ET 200SP in the overall configuration

The figure below shows the overall configuration of the ET 200SP distributed I/O system (load current supply and grounding concept) with supply from a TN-S network.



- ① Main switch
- ② Short-circuit / overload protection
- ③ The load current supply (galvanic isolation)

Figure 5-1 ET 200SP in the overall configuration

5.4 Electrical configuration of the ET 200SP

Electrical isolation

Electrical relationships

With the ET 200SP distributed I/O system, there is electrical isolation between:

- The load circuits/process and all other circuit components of the ET 200SP distributed I/O system.
- The communication interfaces of the CPU (PROFINET) or of the interface module (PROFINET/PROFIBUS) and all other circuit components.

The figures below show the electrical relationships of the ET 200SP distributed I/O system with the CPU and the interface module. Only the most important components are represented in the figures.

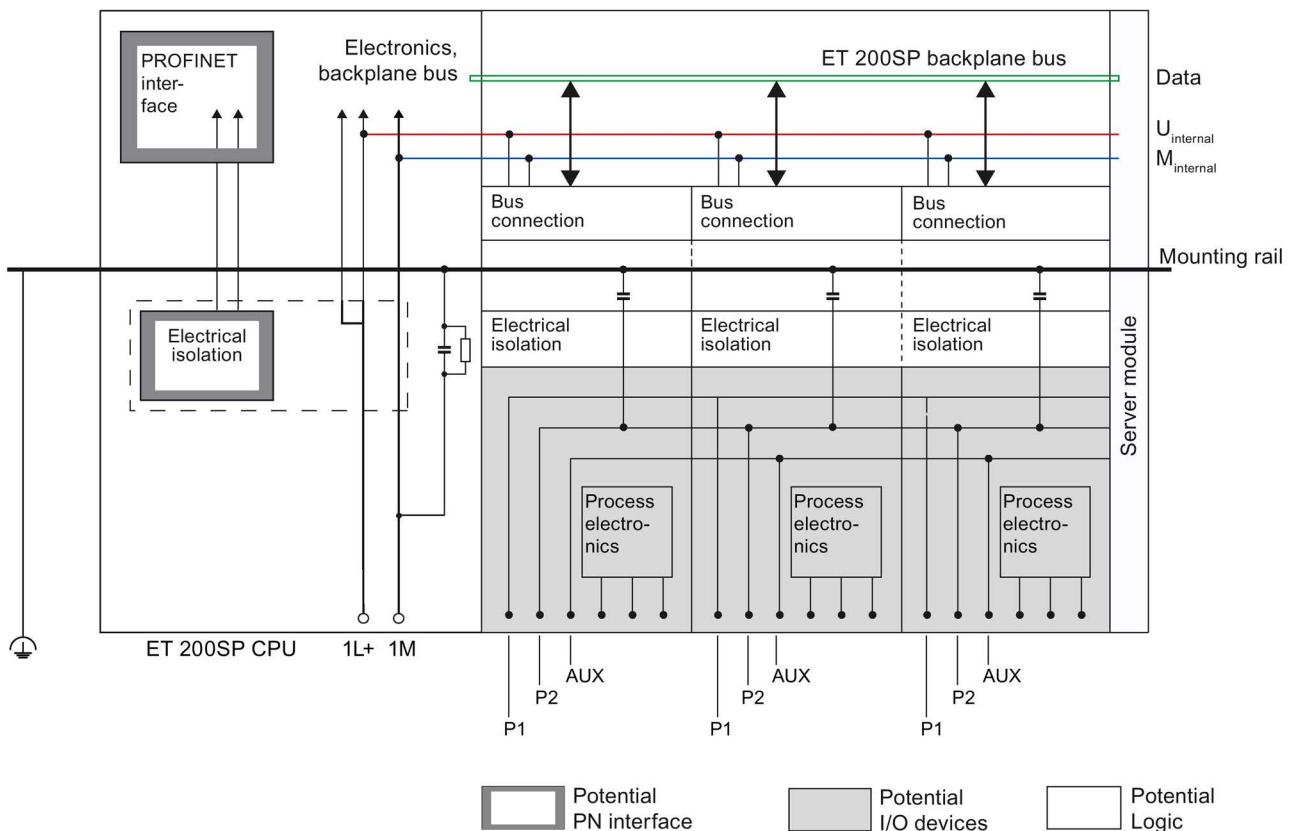


Figure 5-2 Electrical relationships for ET 200SP with CPU

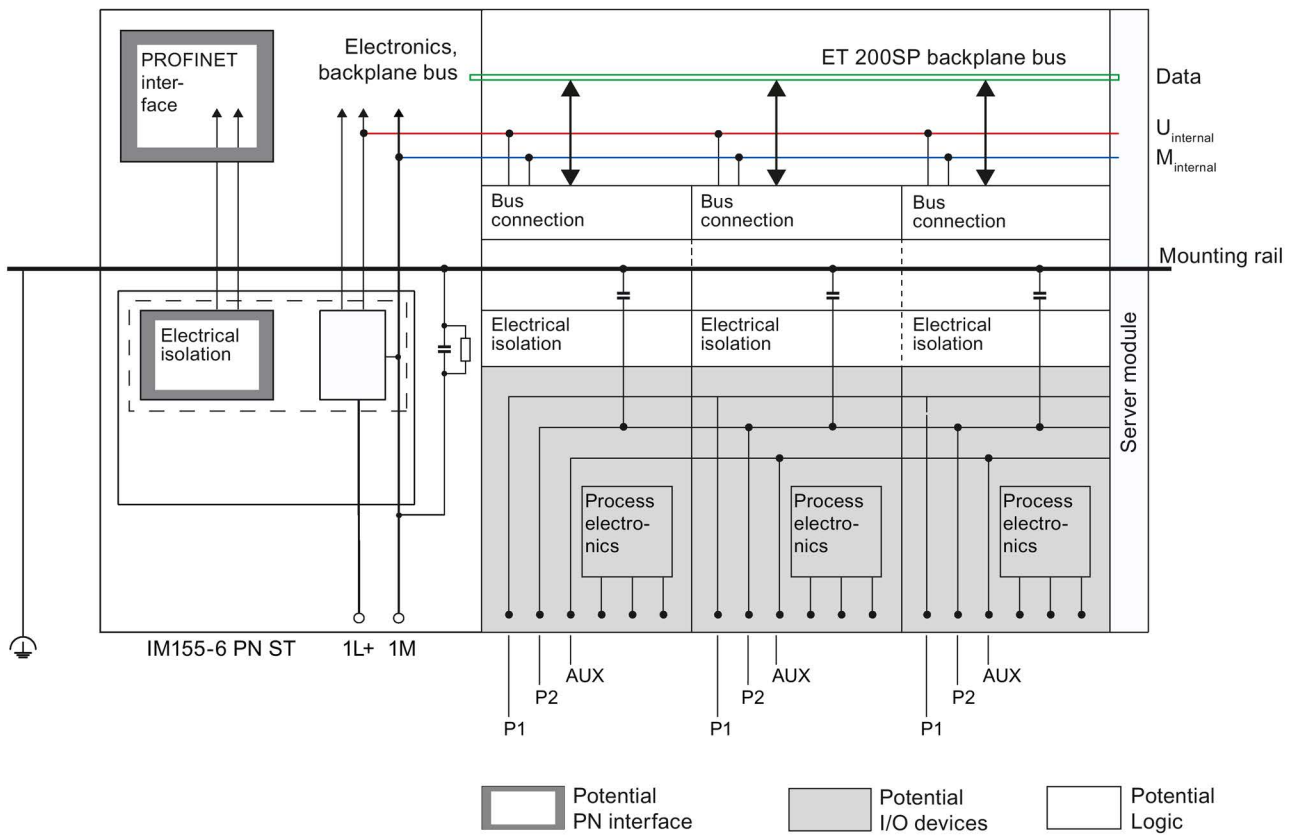


Figure 5-3 Electrical relationships for ET 200SP with interface module (using IM 155-6 PN ST as an example)

5.5 Wiring rules

Wiring rules

Wiring rules for ...		CPU/interface module (supply voltage)	BaseUnits (push-in terminal)
Permitted cable cross-sections of solid cables		0.2 to 2.5 mm ²	
		AWG*: 24 to 13	
Permitted cable cross-sections of flexible cables	Without wire end ferrule	0.2 to 2.5 mm ²	
		AWG*: 24 to 13	AWG*: 24 to 14
	With wire end ferrule (with plastic sleeve)***	0.25 mm to 1.5 mm ^{2**}	0.14 mm to 1.5 mm ²
		AWG*: 24 to 16	AWG*: 26 to 16
	With TWIN wire end ferrule***	0.5 mm to 1 mm ²	0.5 to 0.75 mm ² (see below)
		AWG*: 20 to 17	AWG*: 20 to 18
Stripping length of the wires		8 to 10 mm	
Wire end ferrules in accordance with DIN 46228 with plastic sleeve***		8 and 10 mm long	

* AWG: American Wire Gauge

** Wire end ferrules without plastic sleeve: 0.25 to 2.5 mm²/AWG: 24 to 13

*** See note on Wire end ferrules

Note

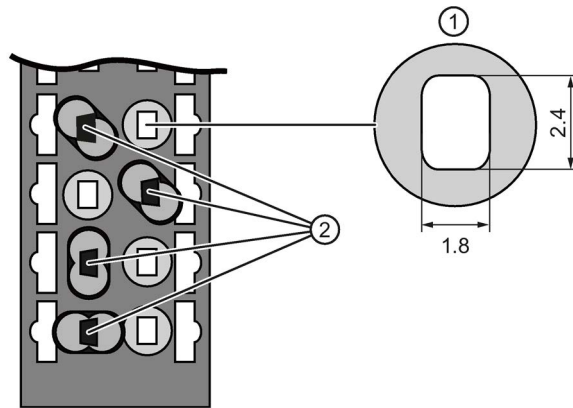
Wire end ferrules

Optimum results with respect to a high-quality and permanent electrical connection with maximum conductor pull forces at the same time can be achieved by using crimping dies, preferably with smooth surfaces, which are provided, for example, with rectangular and trapezoidal crimp cross-sections.

Due to the large number of crimping dies used in the industry, we can recommend others on request. Crimping dies with a pronounced wave profile are unsuitable.

TWIN wire end ferrules for wires of the push-in terminals

Due to the space required by TWIN wire end ferrules with 0.75 mm² cross-section, you must ensure a correct angle for the cable arrangement when crimping the TWIN wire end ferrule so that the cables are optimally arranged.



- ① Cross-section of the terminal compartment
- ② Crimping TWIN wire end ferrules at the correct angle

Figure 5-4 TWIN wire end ferrules

Permissible cable temperature

Note

Permissible cable temperature

The minimum permissible cable temperature must be 30°C higher than the ambient temperature of the ET 200SP (example: At an ambient temperature of 60°C, a connecting cable must be rated for a temperature range of at least 90°C).

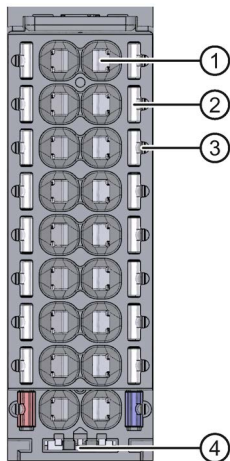
You should specify other connection types and material requirements based on the electrical characteristics of the circuits you use and the installation environment.

5.6 Wiring BaseUnits

Introduction

The BaseUnits connect the ET 200SP distributed I/O system to the process. The following versions of the BaseUnits can be used:

- BaseUnits (with light-colored terminal box) for opening a potential group: BU..D
- BaseUnits (with dark-colored terminal box) for extending the potential group: BU..B
- BaseUnits with additional AUX terminals or additional terminals: BU..+10..
- BaseUnits with integrated thermal resistor for compensation of the reference junction temperature when connecting thermocouples: BU..T



- ① Push-in terminal
- ② Spring release
- ③ Measuring probe (suitable probes: 1 mm diameter, length \geq 10 mm while observing the permitted voltage category)
- ④ Holder for shield connection

Figure 5-5 View of the BaseUnit

Note

The pin assignment of the BaseUnit depends on the connected I/O module. Information on the BaseUnits and I/O modules can be found in the associated manuals.

Replacement of the terminal box on the BaseUnit is described in the section Replacing the terminal box on the BaseUnit (Page 209).

Note

Special terminal designations in the wiring and block diagrams of the I/O modules/BaseUnits

- **RES:** Reserve, these terminals must remain unconnected so that they can be used for future expansions
 - **n.c.:** Not connected, these terminals have no function. However, they can be connected to potentials specifically defined for a module, for example, for the laying of unused wires.
-

Requirements

- The supply voltages are turned off.
- Follow the wiring rules.
- Color identification labels (Page 94) (optional) have been applied.

Required tools

3 to 3.5 mm screwdriver

Tool-free connection of cables: single-wire without wire end ferrule, multi-wire (stranded) with wire end ferrule or ultrasonically sealed

Watch the video sequence (<http://support.automation.siemens.com/WW/view/en/95886218>)

To connect a wire without tools, follow these steps:

1. Strip 8 to 10 mm of the wires.
2. Only for multi-stranded wires:
Seal or crimp the wire with wire end ferrules.
3. Insert the wire into the push-in terminal as far as it will go.

Connection of cables: multi-wire (stranded), without wire end ferrule, unprocessed

To connect a wire without a wire end ferrule, follow these steps:

1. Strip 8 to 10 mm of the wires.
2. Push with the screwdriver into the spring release.
3. Insert the wire into the push-in terminal as far as it will go.
4. Pull the screwdriver out of the spring release.

Removing wires

Using the screwdriver, press the spring release of the terminal as far as it will go and pull out the wire.

Note

When you press the spring release, you should not pull on the wire/cable at the same time. This prevents you from damaging the terminal.

5.7 Connecting cable shields

Introduction

- You need the shield connector to contact cable shields (e.g. for analog modules). The shield connector conducts interference currents on cable shields to ground via the mounting rail. It is not necessary to contact the shield at where the cable enters the cabinet.
- Attach the shield connector to the BaseUnit.
- The shield connector consists of a shield contact and a shield terminal.
- The shield connector is automatically connected to the functional ground (FG) of the mounting rail after installation.

Requirements

- BaseUnit with a width of 15 mm
- The shield terminal is suitable for cables with max. \varnothing 7 mm each.

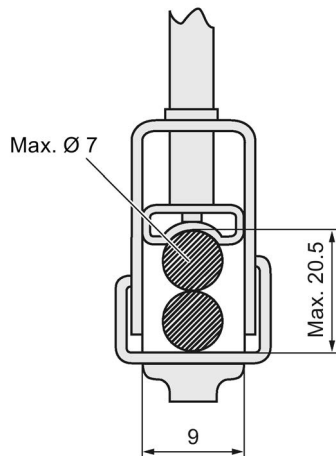


Figure 5-6 Shield terminal

Required tools

- Stripping tool

Procedure

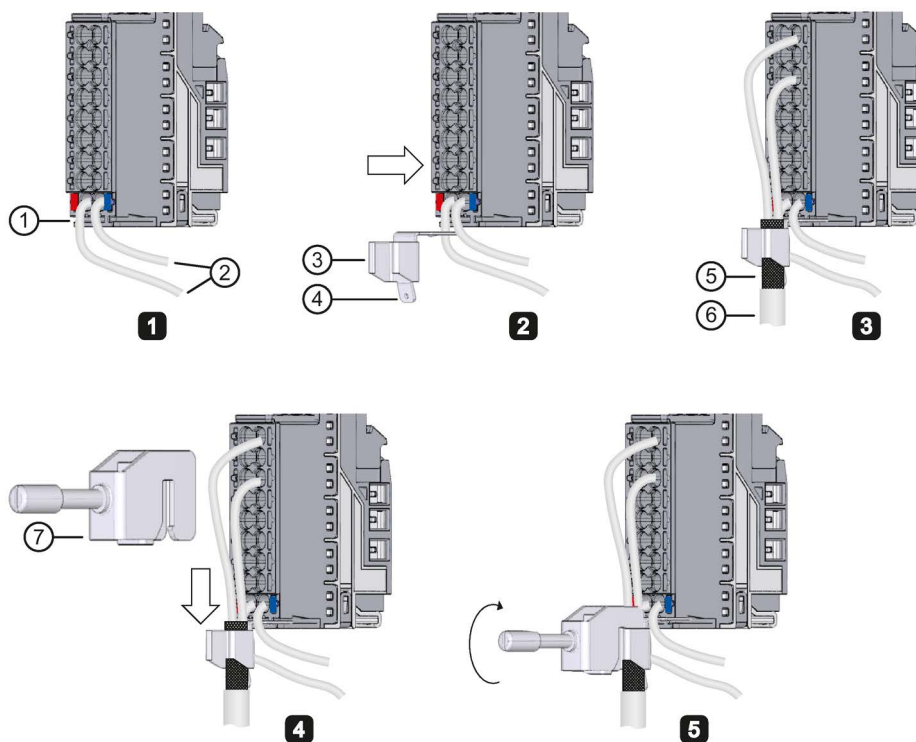
Watch the video sequence (<http://support.automation.siemens.com/WW/view/en/95886218>)

To connect the cable shield, follow these steps:

1. If necessary, connect the supply voltage L+ and ground to the BaseUnit.
2. Press the shield contact up into the mount until you hear it click into place.
3. Remove the cable insulation material around the shield terminal.

Connect the cable to the BaseUnit and place the cable in the shield contact.

4. Insert the shield terminal into the shield contact.
5. Tighten the shield terminal with approximately 0.5 Nm.



- | | | | |
|---|--|---|---|
| ① | Mount | ⑤ | Insulation material removed (approx. 20 mm) |
| ② | Supply voltage L+, ground | ⑥ | Cable to the encoder |
| ③ | Shield contact | ⑦ | Shield terminal |
| ④ | Flat connector for push-on contacts (6.3 × 0.8 mm) | | |

Figure 5-7 Mounting the shield contact

5.8 Connecting the supply voltage to the CPU/interface module

Introduction

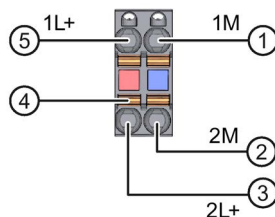
The supply voltage of the CPU/interface module is supplied by means of a 4-pin connector plug located on the front of the CPU/interface module.

Power supply unit

Only use power supply units of type SELV/PELV with safe electrically isolated functional extra low voltage (≤ 28.8 V DC).

Connection for supply voltage (X80)

The connections have the following meaning:



- ① Ground of the supply voltage
- ② Ground of the supply voltage for looping through (permitted value 10 A)
- ③ + 24 V DC of the supply voltage for looping through (permitted value 10 A)
- ④ Spring NC contacts
- ⑤ + 24 V DC of the supply voltage

1L+ and 2L+ and 1M and 2M are internally jumpered.

Figure 5-8 Supply voltage connection

The maximum cross-section of the connection is 2.5 mm². A strain relief is not present. The connector plugs provide you with the option of looping the supply voltage through without interruption, even when it is unplugged.

Requirements

- Only wire up the connector plug when the supply voltage is turned off.
- Follow the wiring rules (Page 60).

Required tools

3 to 3.5 mm screwdriver

Tool-free connection of cables: single-wire without wire end ferrule, multi-wire (stranded) with wire end ferrule or ultrasonically sealed

Watch the video sequence (<http://support.automation.siemens.com/WW/view/en/95886218>)

To connect a wire without tools, follow these steps:

1. Strip 8 to 10 mm of the wires.
2. Only for multi-stranded wires:
Seal or crimp the wire with wire end ferrules.
3. Insert the wire into the push-in terminal as far as it will go.
4. Push the wired connector plug into the plug socket of the interface module.

Connection of cables: multi-wire (stranded), without wire end ferrule, unprocessed

To connect a wire without a wire end ferrule, follow these steps:

1. Strip 8 to 10 mm of the wires.
2. Using a screwdriver, press the spring opener and insert the wire into the push-in terminal as far as it will go.
3. Pull the screwdriver out of the spring opener.
4. Push the wired connector plug into the socket in the interface module.

Removing a wire

Using the screwdriver, press the spring opener as far as it will go and pull out the wire.

5.9 Connecting interfaces for communication

Connect the communication interfaces of the ET 200SP distributed I/O system using the standardized connector or directly. If you want to prepare communication cables yourself, the interface assignment is specified in the manuals of the corresponding modules. Observe the mounting instructions for the connectors.

5.9.1 Connecting PROFINET IO to the CPU/interface module via the bus adapter BA 2xRJ45

Introduction

You connect PROFINET IO to the CPU/interface module via the BusAdapter BA 2xRJ45. To do this, screw the BusAdapter BA 2xRJ45 to the CPU/interface module and insert the PROFINET connecting cable. You can loop PROFINET through via the integrated 2-port switch.

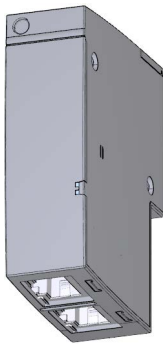


Figure 5-9 Bus adapter BA 2xRJ45

Required tools

3 to 3.5 mm screwdriver

Required accessories

Please refer to the specifications in the PROFINET Installation Guide (<http://www.profibus.com>).

Mounting the bus connector

Mount the PROFINET connector according to the instructions in PROFINET Installation Guide (<http://www.profibus.com>).

Procedure

Watch the video sequence (<http://support.automation.siemens.com/WW/view/en/95886218>)

To connect PROFINET IO to the CPU/interface module via the BA 2xRJ45 BusAdapter, follow these steps:

1. Plug the BusAdapter BA 2xRJ45 into the CPU/interface module.
2. Screw the BA 2xRJ45 BusAdapter to the CPU/interface module (1 screw with 0.2 Nm tightening torque). To do this, use a screwdriver with a 3 to 3.5 mm blade.
3. Plug the RJ45 bus connector(s) into the PROFINET port on the BusAdapter BA 2xRJ45.

Bus adapter BA 2xRJ45 mounted

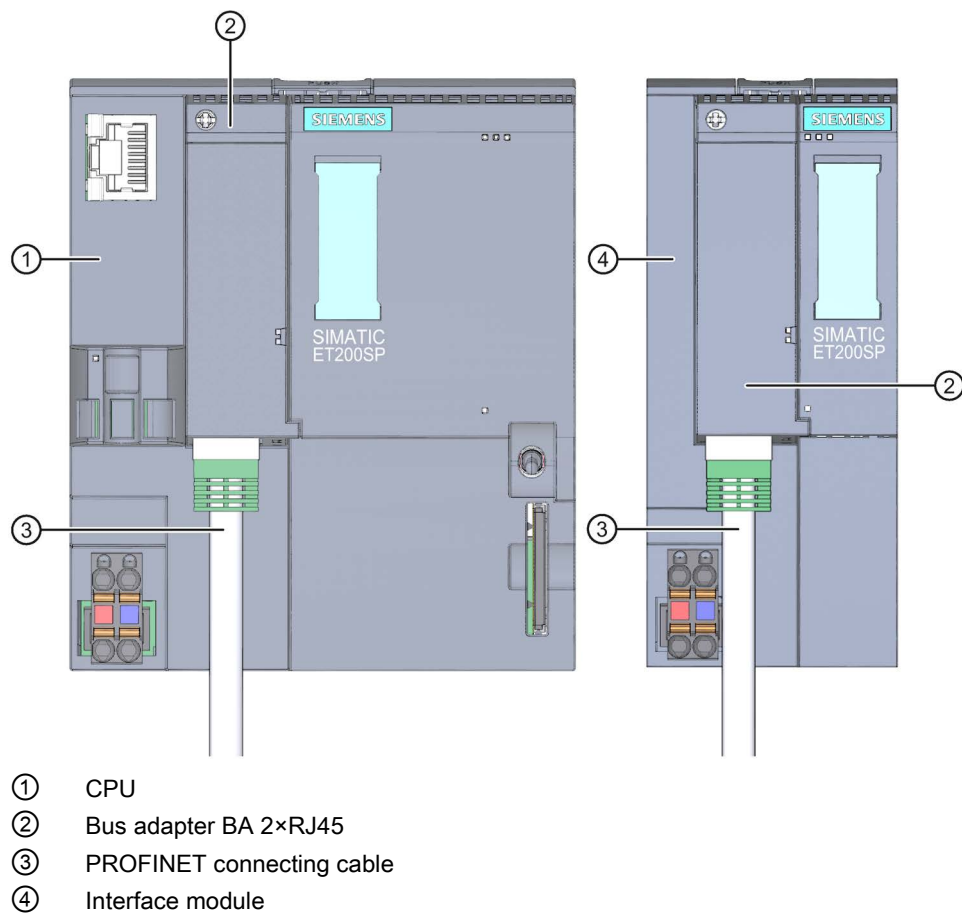


Figure 5-10 Connecting BusAdapter BA 2xRJ45 to the CPU/interface module

Note

Installation guidelines for modules with PROFINET IO interfaces

Only when all connected nodes are equipped with a SELV/PELV power supply (or have equivalent protection), is it permitted to operate the modules with PROFINET IO interfaces in LANs (Local Area Networks).

A data transfer point is prescribed for connection to the WAN(Wide Area Network) that guarantees this degree of safety.

5.9.2 Connecting PROFINET IO to the CPU/interface module via the BA 2xFC BusAdapter

Introduction

You connect PROFINET IO to the CPU/interface module via the BusAdapter BA 2xFC. To do this, screw the BusAdapter BA 2xFC to the connected PROFINET connecting cable on the CPU/interface module. You can loop PROFINET through via the integrated 2-port switch.

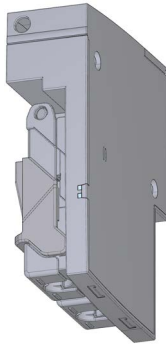


Figure 5-11 BA 2xFC BusAdapter

Required tools

3 to 3.5 mm screwdriver

Required accessories

- If you use Fast Connect Cable, we recommend the Industrial Ethernet Fast Connect Stripping Tool (6GK1901-1GA00) with green knife cassette (6GK1901-1B...). This guarantees fast and safe stripping.
- Fast Connect Cable (recommended types):
 - IE FC TP Standard Cable GP 2x2 (6XV1840-2AH10)
 - IE FC TP Trailing Cable 2x2 (6XV1840-3AH10)
 - IE FC TP Marine Cable (6XV1840-4AH10)
 - IE FC TP Flexible Cable GP 2x2 (6XV1870-2B)
 - IE FC TP Trailing Cable 2x2 (6XV1870-2D)
 - IE TP Torsion Cable 2x2 (6XV1870-2F)
 - FC TP FRNC Cable GP (6XV1871-2F)
 - IE FC TP Food Cable GP 2x2 (6XV1871-2L)
 - IE FC TP Festoon Cable 2x2 (6XV1871-2S)
- Please refer to the specifications in the PROFINET Installation Guide (<http://www.profibus.com>).

Procedure

Watch the video sequence (<http://support.automation.siemens.com/WW/view/en/95886218>)

To connect PROFINET IO to the CPU/interface module via the BA 2xFC BusAdapter, follow these steps:

1. Strip the sleeve of the PROFINET connecting cable as follows:

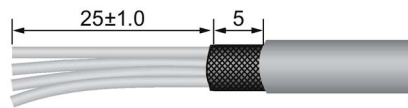
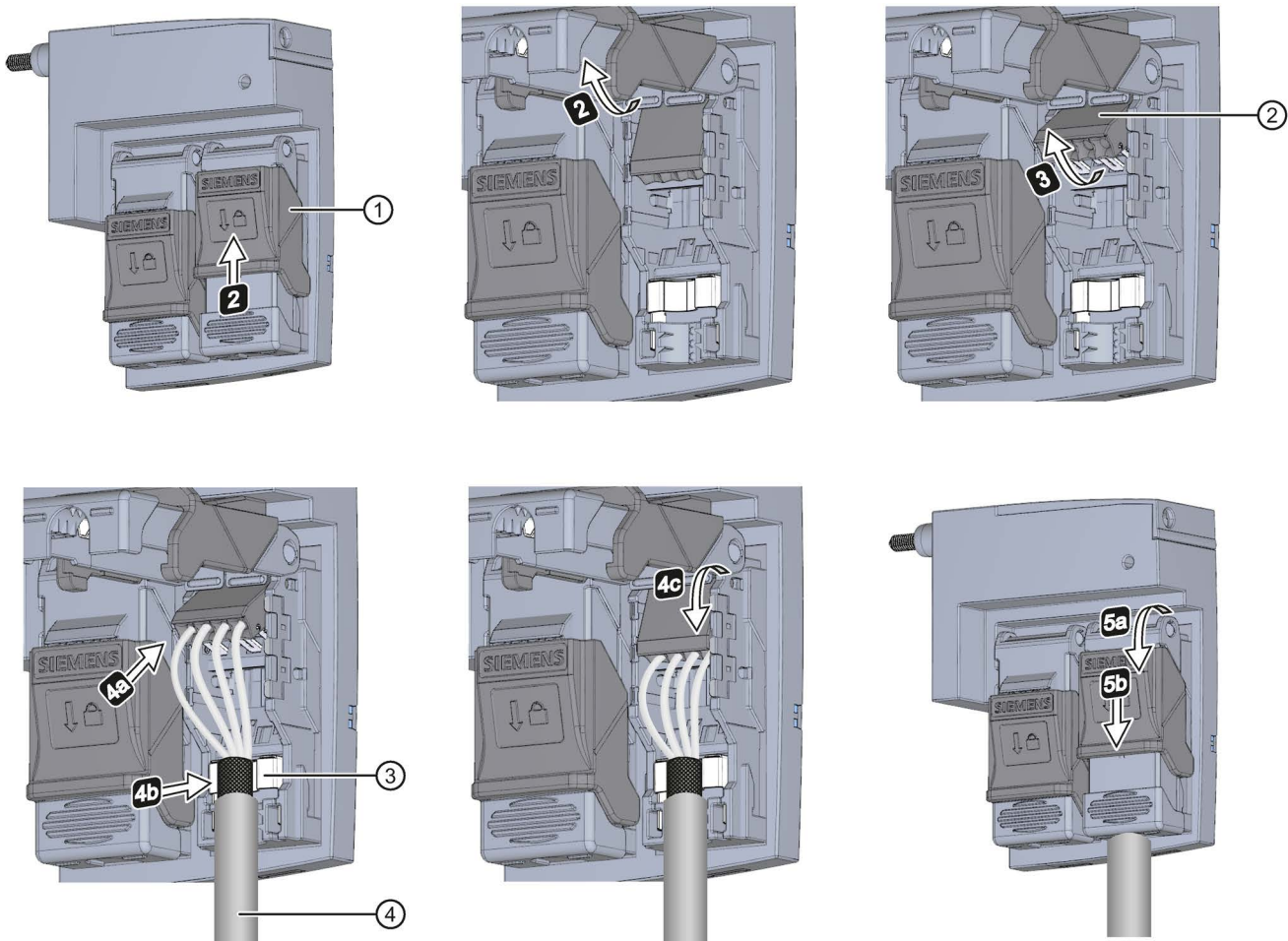


Figure 5-12 PROFINET connecting cable

2. Pull back the locking slide and fold up the cover of the connection element.
3. Pull up the wire guide as far as it will go.
4. Insert the unstripped single wires of the PROFINET connecting cable (according to the attached color coding) into the wire guide and press the guide down **firmly** as far as it will go.

5.9 Connecting interfaces for communication

5. Close the cover of the connection element and push the locking slide forwards as far as it will go.
6. Connect and screw the BA 2×FC BusAdapter to the CPU/interface module (1 screw with 0.2 Nm tightening torque). To do this, use a screwdriver with a 3 to 3.5 mm blade.



- | | |
|---|---|
| <ul style="list-style-type: none"> ① Locking slide ② Wire guide | <ul style="list-style-type: none"> ③ Shield contact ④ PROFINET connecting cable |
|---|---|

Figure 5-13 Connection of the PROFINET IO BusAdapter BA 2×FC to the CPU/interface module

BA 2×FC BusAdapter mounted

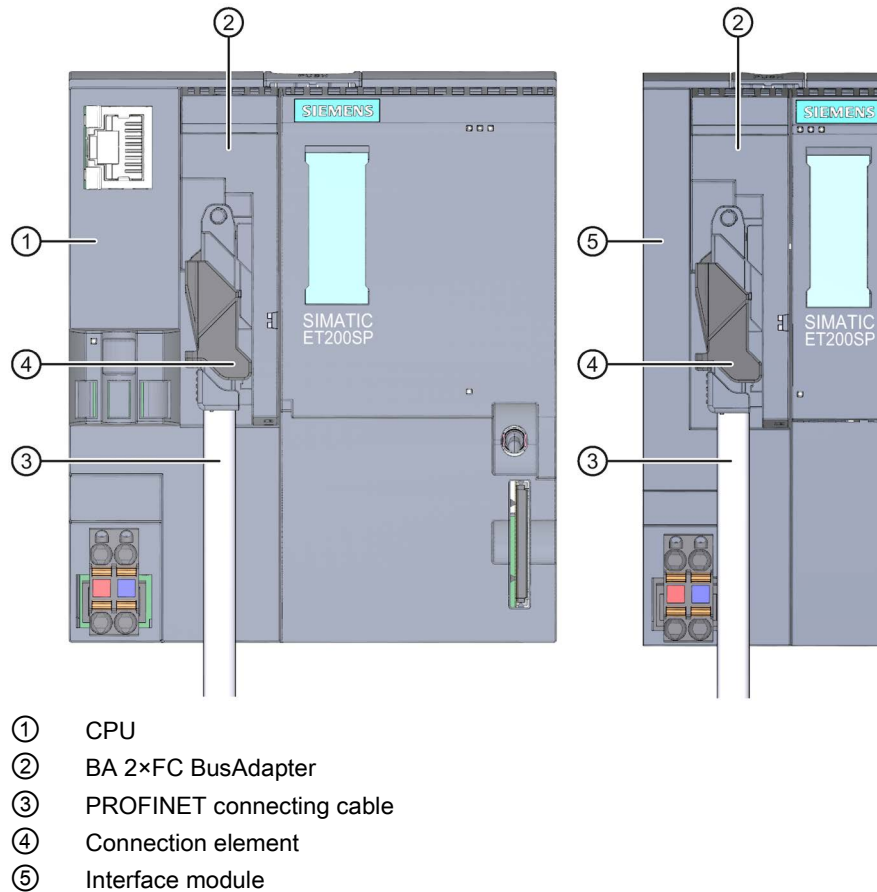


Figure 5-14 Connecting the BA 2×FC BusAdapter to the CPU/interface module

Note**Installation guidelines for modules with PROFINET IO interfaces**

Only when all connected nodes are equipped with a SELV/PELV power supply (or have equivalent protection) is it permitted to operate the modules with PROFINET IO interfaces in LANs (Local Area Networks).

A data transfer point is prescribed for connection to the WAN (Wide Area Network) that guarantees this degree of safety.

5.9.3 Connecting PROFINET IO to the CPU/interface module via BA 2xSCRJ BusAdapter

Introduction

You can connect PROFINET IO to the CPU/interface module optically with fiber-optic cables using an SC RJ connector via the BA 2xSCRJ BusAdapter. To do this, screw the BA 2xSCRJ BusAdapter onto the CPU/interface module and insert the SC RJ connector. You can loop PROFINET through optically via the integrated 2-port switch.

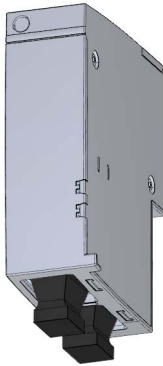


Figure 5-15 BA 2xSCRJ BusAdapter

Required tools

3 to 3.5 mm screwdriver

Required accessories

- Connector for PROFINET connection: IE SC RJ POF plug
- Fiber-optic cable:
 - IE POF standard cable (6XV1874-2A)
 - IE POF trailing cable (6XV1874-2B)
 - IE PCF standard cable (6XV1861-2A)
 - IE PCF trailing cable (6XV1861-2C)
 - IE PCF-GI (6XV1861-2D)

Requirements

- Prepare the IE POF cables with the connectors IE SC RJ POF Plug or IE SC RJ PCF Plug. For detailed information, refer to the assembly instructions POF Fiber-optic Cables with IE Termination Kit SC RJ POF Plug (A5E00351141) or PCF Fiber-optic Cables with the IE Termination Kit SC RJ PCF Plug (A5E00835119).
- When installing the fiber-optic cable, make sure the bending radius is not less than permitted:
 - IE POF/PCF standard cable: 150 mm
 - IE POF/PCF trailing cable: 60 mm
- The maximum lengths of the fiber-optic cables are as follows:
 - IE POF standard cable: 50 m
 - IE POF trailing cable: 50 m
 - IE POF standard cable: 100 m
 - IE PCF trailing cable: 100 m
 - IE PCF-GI: 300 m
- If the CPU/interface module is the last device of the fiber-optic cable network, the unoccupied fiber-optic cable interface must be closed with a blanking plug. When the modules ship, the blanking plugs are inserted in the PROFINET sockets of the BusAdapter.

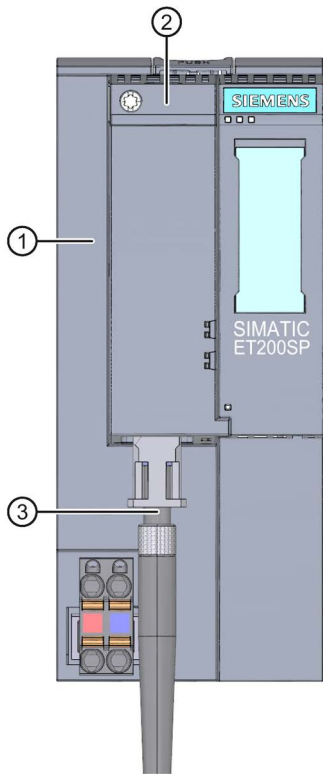
Procedure

To connect PROFINET IO to the CPU/interface module via the BA 2×SCRJ BusAdapter, follow these steps:

1. Plug the BA 2×SCRJ BusAdapter into the CPU/interface module.
2. Screw the BA 2×SCRJ BusAdapter to the CPU/interface module (1 screw with 0.2 Nm tightening torque). To do this, use a screwdriver with a 3 to 3.5 mm blade.
3. Remove the blanking plugs from the PROFINET sockets.
4. Hold the prepared connector by the housing and insert it into the PROFINET socket on the BA 2×SCRJ BusAdapter until you hear it click into place. The connectors are coded to ensure correct connection.

 CAUTION
Risk of damage to eyes
Do not look directly into the opening of the optical transmitter diodes. The emitted light beam could damage your eyes.

BA 2×SCRJ BusAdapter mounted



- ① Interface module
- ② BA 2×SCRJ BusAdapter
- ③ PROFINET connecting cable (fiber-optic cable)

Figure 5-16 Connecting the BA 2×SCRJ BusAdapter to the interface module

Reusing fiber-optic cable

Note

If you are reusing fiber-optic cables, you must shorten both fiber-optic cores by the amount of the curved lengths and reassemble the connectors. This will prevent any attenuation losses caused by re-bent, heavily stressed portions of the fiber-optic cores.

Reference

For more information on the installation guidelines for fiber-optic cables, refer to the SIMATIC NET PROFIBUS Network Manual (<http://support.automation.siemens.com/WW/view/en/35222591>).

5.9.4 Connecting PROFINET IO to the interface module via the BA SCRJ/RJ45 BusAdapter

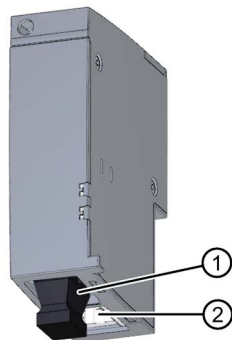
Introduction

You connect PROFINET IO to the interface module via the BA SCRJ/RJ45 BusAdapter:

- Optically coupled to fiber-optic cables (FOC) with an SC RJ connector (port 1) or
- Electrically with a standard RJ45 connector (port 2)

To do this, screw the BA SCRJ/RJ45 BusAdapter onto the interface module and insert the SC RJ connector or RJ45 plug.

You can loop through the PROFINET IO via the integrated 2-port switch. You can use any port of the BusAdapter for feeding or for looping through. The integrated media converter converts the signals automatically.



- ① Fiber-optic cable SCRJ
- ② RJ45

Figure 5-17 BA SCRJ/RJ45 BusAdapter

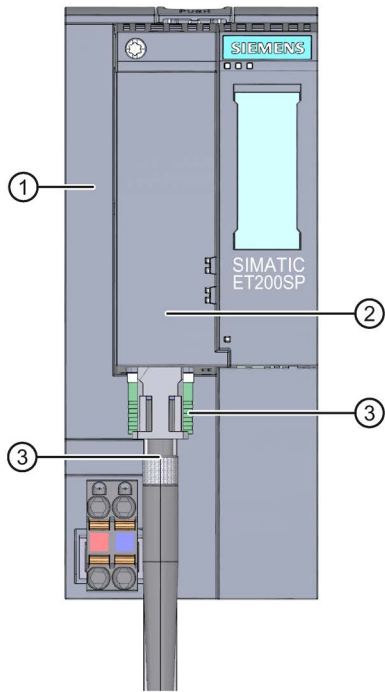
Attaching SC RJ connectors

You can find more information about the required tools, accessories, requirements and procedures in the section Connecting PROFINET IO to an interface module via BA 2×SCRJ BusAdapter (Page 74).

Connecting RJ45 plugs

You can find more information about the required tools, accessories and procedures in the section Connecting PROFINET IO to an interface module via BA 2×RJ45 BusAdapter (Page 68).

BA SCRJ/RJ45 BusAdapter mounted



- ① Interface module
- ② BA SCRJ/RJ45 BusAdapter
- ③ PROFINET connecting cable

Figure 5-18 Connecting the BA SCRJ/RJ45 BusAdapter to the interface module

5.9.5 Connecting PROFINET IO to the interface module via the BA SCRJ/FC BusAdapter

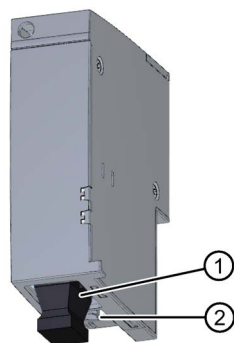
Introduction

You connect PROFINET IO to the interface module via the BA SCRJ/FC BusAdapter:

- Optically coupled to fiber-optic cables (FOC) with an SC RJ connector (port 1) or
- Electrically with direct connection of the Fast Connect bus cable (port 2)

To do this, screw the BA SCRJ/FC BusAdapter with the attached Fast Connect bus cable onto the interface module and insert the SC RJ connector.

You can loop through the PROFINET IO via the integrated 2-port switch. You can use any port of the BusAdapter for feeding or for looping through. The integrated media converter converts the signals automatically.



- ① Fiber-optic cable SCRJ
- ② FastConnect FC

Figure 5-19 BA SCRJ/FC BusAdapter

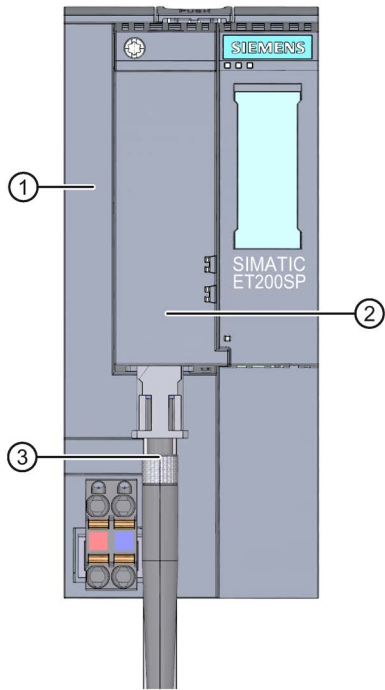
Attaching SC RJ connectors

You can find more information about the required tools, accessories, requirements and procedures in the section Connecting PROFINET IO to an interface module via BA 2×SCRJ BusAdapter (Page 74).

Connecting a Fast Connect bus cable

You can find more information about the required tools, accessories and procedures in the section Connecting PROFINET IO to an interface module via BA 2×FC BusAdapter (Page 70).

BA SCRJ/FC BusAdapter mounted



- ① Interface module
- ② BA SCRJ/FC BusAdapter
- ③ PROFINET connecting cable

Figure 5-20 Connecting the BA SCRJ/FC BusAdapter to the interface module

5.9.6 Connecting PROFINET IO to the interface module via the BA 2xLC BusAdapter

Introduction

Via the BA 2xLC BusAdapter, you connect the PROFINET IO to the interface module optically with fiber-optic cables using an LC connector. To do this, screw the BA 2xLC BusAdapter onto the interface module and insert the LC connector. You can loop PROFINET through optically via the integrated 2-port switch.

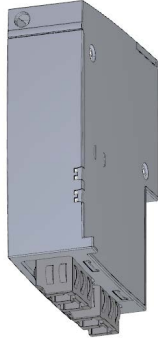


Figure 5-21 BA 2xLC BusAdapter

Required tools

3 to 3.5 mm screwdriver

Required accessories

- If you prepare the FC FO cable with the IE FC FO LC plug, we recommend the FC FO termination kit (LC) (6GK1900-0RL00-0AA0). You can cleave the glassfiber precisely using the FC FO termination kit (LC).

 CAUTION
Cleaving the glassfiber <ul style="list-style-type: none"> • Wear protective glasses during the cleaving process. • Dispose of the remaining fibers in a suitable waste container.

- Connector for PROFINET connection: IE FC FO LC Plug (10 duplex plugs: 6GK1900-1RB00-2AB0)
- Fiber-optic cable:
 - IE FC FO Standard Cable GP (62.5/200/230) (6XV1847-2A)
 - IE FC FO Trailing Cable (62.5/200/230) (6XV1847-2C)
 - IE FC FO Robust Cable (6XV1873-5Rxx)
 - IE FC FO Standard Cable (6XV1873-3Axx)

Requirements

- Prepare the IE FC FO cable with the IE FC FO LC plug connectors. For detailed instructions, refer to the assembly instructions Preparing IE FC FO Cable with the plug-in connector IE FC FO LC Plug (A5E36312721).
- When installing the fiber-optic cable, make sure the bending radius is not less than permitted:
 - IE FC FO Standard Cable GP (62.5/200/230): 70 mm
 - IE FC FO Trailing Cable (62.5/200/230) (6XV1847-2C): 88 mm
- The maximum lengths of the fiber-optic cables are as follows:
 - IE FC FO Standard Cable GP (62.5/200/230): 2 km
 - IE FC FO Trailing Cable (62.5/200/230): 2 km
- When the interface module is the last device of the fiber-optic cable network, the unoccupied fiber-optic cable interface must be closed with a blanking plug. When the modules ship, the blanking plugs are inserted in the PROFINET sockets of the BusAdapter.

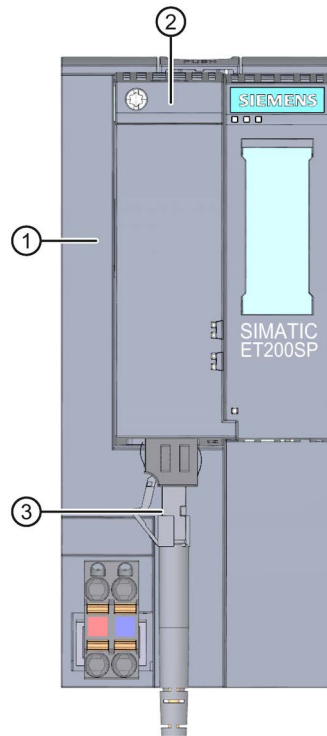
Procedure

To connect PROFINET IO to the interface module via the BA 2xLC BusAdapter, follow these steps:

1. Plug the BA 2xLC BusAdapter into the interface module.
2. Screw the BA 2xLC BusAdapter to the interface module (1 screw with 0.2 Nm tightening torque). To do this, use a screwdriver with a 3 to 3.5 mm blade.
3. Remove the blanking plugs from the PROFINET sockets.
4. Hold the prepared connector by the housing and insert it into the PROFINET socket on the BA 2xLC BusAdapter until you hear it click into place. The connectors are coded to ensure correct connection.

 CAUTION
Risk of damage to eyes
Do not look directly into the opening of the optical transmitter diodes. The emitted light beam could damage your eyes.

BA 2xLC BusAdapter mounted



- ① Interface module
- ② BA 2xLC BusAdapter
- ③ PROFINET glassfiber connecting cable

Figure 5-22 Connecting the BA 2xLC BusAdapter to the interface module

Reusing fiber-optic cable

Note

If you are reusing fiber-optic cables, you must shorten both fiber-optic cores by the amount of the curved lengths and reassemble the connectors. This will prevent any attenuation losses caused by re-bent, heavily stressed portions of the fiber-optic cores.

Reference

For more information on the installation guidelines for fiber-optic cables, refer to the SIMATIC NET PROFIBUS Network Manual (<http://support.automation.siemens.com/WW/view/en/35222591>).

5.9.7 Connecting PROFINET IO to the interface module via the BA LC/RJ45 BusAdapter

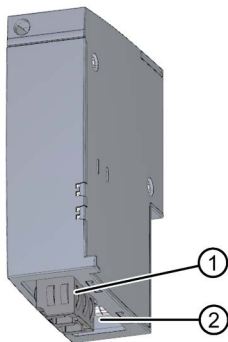
Introduction

You connect PROFINET IO to the interface module via the BA LC/RJ45 BusAdapter:

- Optically coupled to glass fiber-optic cables with an LC connector (port 1) or
- Electrically with a standard RJ45 connector (port 2)

To do this, screw the BA LC/RJ45 BusAdapter onto the interface module and insert the LC connector or RJ45 plug.

You can loop through the PROFINET IO via the integrated 2-port switch. You can use any port of the BusAdapter for feeding or for looping through. The integrated media converter converts the signals automatically.



- ① Glass fiber-optic cable LC
- ② RJ45

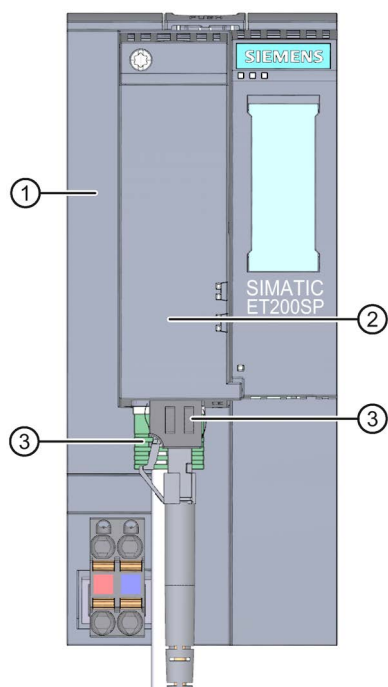
Figure 5-23 BA LC/RJ45 BusAdapter

Attaching LC connectors

You can find more information about the required tools, accessories, requirements and procedures in the section Connecting PROFINET IO to an interface module via BA 2×LC BusAdapter (Page 81).

Connecting RJ45 plugs

You can find more information about the required tools, accessories and procedures in the section Connecting PROFINET IO to an interface module via BA 2×RJ45 BusAdapter (Page 68).

BA LC/RJ45 BusAdapter mounted

- ① Interface module
- ② BA LC/RJ45 BusAdapter
- ③ PROFINET connecting cable

Figure 5-24 Connecting the BA LC/RJ45 BusAdapter to the interface module

5.9.8 Connecting PROFINET IO to interface module via BA LC/FC BusAdapter

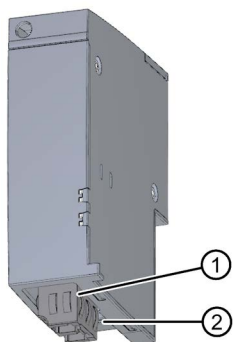
Introduction

You connect PROFINET IO to the interface module via the BA LC/FC BusAdapter:

- Optically coupled to glass fiber-optic cables with an LC connector (port 1) or
- Electrically with direct connection of the Fast Connect bus cable (port 2)

To do this, screw the BA LC/FC BusAdapter with the attached Fast Connect bus cable onto the interface module and insert the LC connector.

You can loop through the PROFINET IO via the integrated 2-port switch. You can use any port of the BusAdapter for feeding or for looping through. The integrated media converter converts the signals automatically.



- ① Glass fiber-optic cable LC
- ② FastConnect FC

Figure 5-25 BA LC/FC BusAdapter

Attaching LC connectors

You can find more information about the required tools, accessories, requirements and procedures in the section Connecting PROFINET IO to an interface module via BA 2×LC BusAdapter (Page 81).

Connecting a Fast Connect bus cable

You can find more information about the required tools, accessories and procedures in the section Connecting PROFINET IO to an interface module via BA 2×FC BusAdapter (Page 70).

BA LC/FC BusAdapter mounted

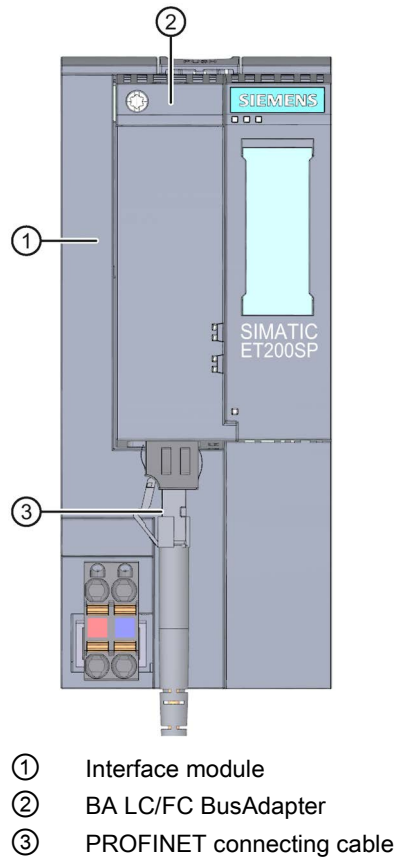


Figure 5-26 Connecting the BA LC/FC BusAdapter to the interface module

5.9.9 Connecting PROFINET IO (port P3) to the CPU

Introduction

You use the RJ-45 bus connector to connect PROFINET IO (port P3) directly to the CPU.

Required accessories

- Cable ties with standard width of 2.5 mm or 3.6 mm for strain relief
- Please observe the specifications in the PROFINET Installation Guide (<http://www.profibus.com>).

Mounting the bus connector

Mount the PROFINET connector in accordance with the instructions in the PROFINET Installation Guide (<http://www.profibus.com>).

Procedure

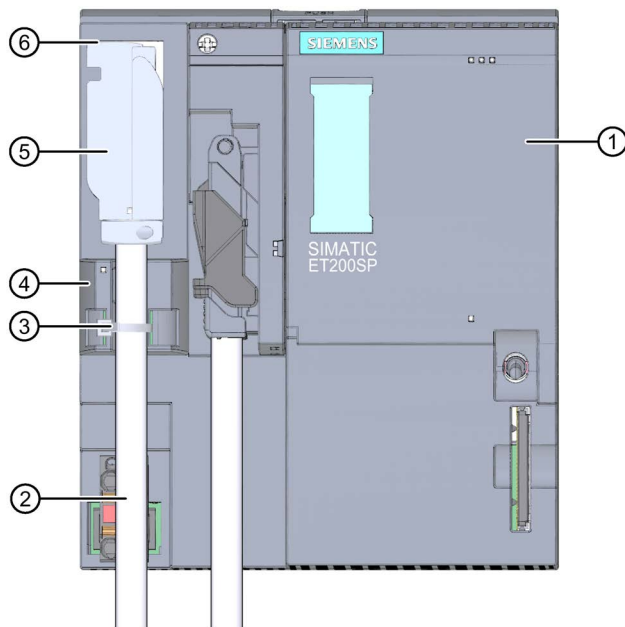
Insert the RJ45 bus connector into the PROFINET port (port P3) on the CPU.

Note

Cable support and strain relief

If you are using a FastConnect RJ-45 bus connector with 90° cable outlet (6GK1901-1BB20-2AA0), we recommend you provide strain relief for the PROFINET connecting cable. To do so, you need a cable tie with a standard width of 2.5 mm or 3.6 mm.

Use it to fasten the PROFINET connecting cable directly after it exits the bus connector to the intended cable support on the CPU (on the front directly below the PROFINET interface X1P3).



- ① CPU
- ② PROFINET connecting cable
- ③ Strain relief (cable tie)
- ④ Cable support
- ⑤ FastConnect RJ45 bus connector with 90° cable outlet
- ⑥ PROFINET connector (port P3)

Figure 5-27 Connecting PROFINET IO (port P3) to the CPU

5.9.10 Connecting the PROFIBUS DP interface to the interface module/communications module CM DP

Introduction

Using the bus connector (RS485), connect the PROFIBUS DP to the interface module/communications module CM DP.

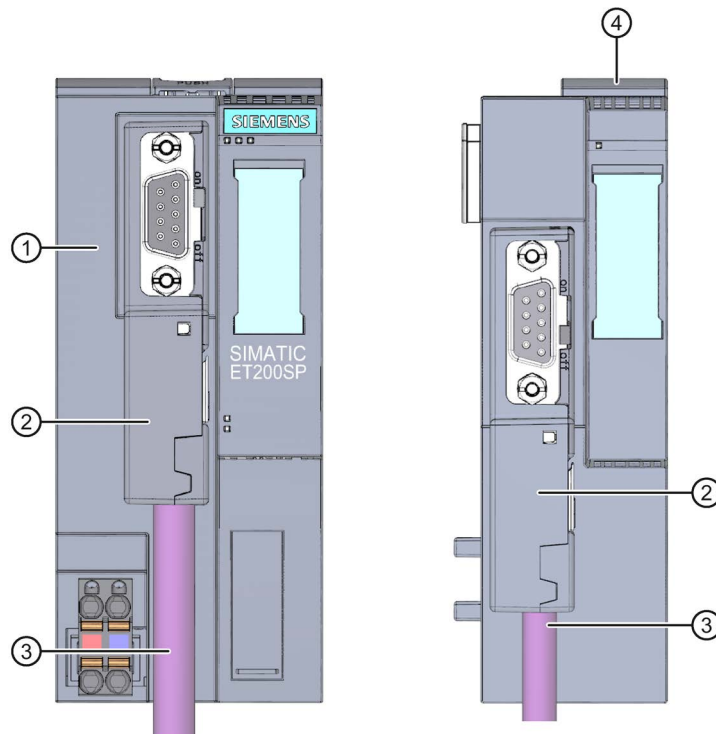
Required tools

3 to 3.5 mm screwdriver

Procedure

To connect the PROFIBUS DP interface to the interface module / DP communication module CM DP, follow these steps:

1. Connect the PROFIBUS cable to the bus connector.
2. Plug the bus connector into the PROFIBUS DP connector.
3. Securely tighten the fixing screws of the bus connector (0.3 Nm).



- ① Interface module
- ② PROFIBUS FastConnect bus connector
- ③ PROFIBUS connecting cable
- ④ Communications module CM DP

Figure 5-28 Connect PROFIBUS DP to the interface module/communications module CM DP

Reference

You can find additional information on the PROFIBUS FastConnect bus connector in the corresponding product information on the Internet (<http://support.automation.siemens.com/WW/view/en/58648998>).

5.10 Plugging in I/O modules and BU covers

Introduction

- The I/O modules are plugged into the BaseUnits. They are self-coding and type-coded.
- The BU covers are fitted to BaseUnits whose slots are not equipped with I/O modules.

The BU covers have a holder for the reference identification label on the inside. For future expansion of the ET 200SP, remove the reference identification label from the holder and insert it into the final I/O module.

It is not possible to attach a reference identification label to the BU cover itself.

There are two versions:

- BU cover with a width of 15 mm
- BU cover with a width of 20 mm

Requirement

Refer to the section Selecting a suitable BaseUnit (Page 26).

Plugging in I/O modules and BU covers

Watch the video sequence (<http://support.automation.siemens.com/WW/view/en/95886218>)

Install the I/O module or BU cover parallel into the BaseUnit until you hear both latches click into place.

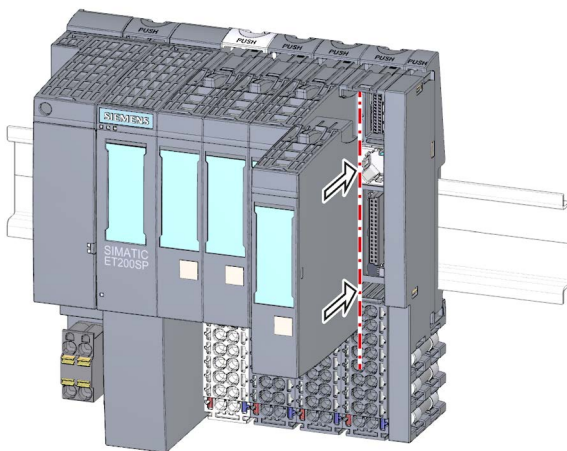


Figure 5-29 Plugging in I/O modules or BU covers (using an I/O module as example)

5.11 Labeling ET 200SP

5.11.1 Factory markings

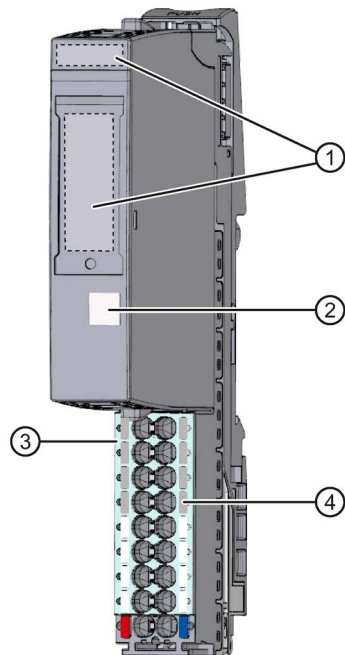
Introduction

For better orientation, the ET 200SP is equipped with various markings ex factory, which help in the configuration and connection of the modules.

Factory markings

- Module labeling
- Color coding of the module classes
 - Digital input modules: white
 - Digital output modules: black
 - Analog input modules: light blue
 - Analog output modules: dark blue
 - Technology module: turquoise
 - Communication module: light gray
 - Special module: mint green

- Color coding of the potential group
 - Opening the potential group: Light-colored terminal box and light-colored mounting rail release button
 - Further conduction of the potential group: Dark-colored terminal box and dark-colored mounting rail release button
- Color coding of the spring releases
 - Process terminals: gray, white
 - AUX terminals: turquoise
 - Additional terminals: red, blue
 - Terminals for self-assembling voltage buses P1, P2: red, blue



- ① Module labeling
- ② Color coding of the module classes
- ③ Color coding of the potential group
- ④ Color coding of the spring releases (by group)

Figure 5-30 Factory markings

5.11.2 Optional markings

Introduction

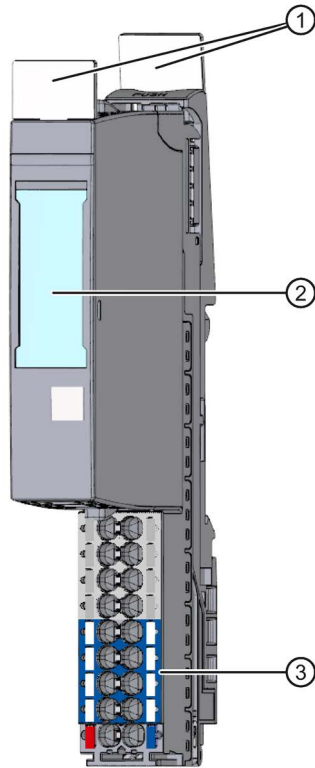
In addition to the factory markings, there are also other options for labeling and/or marking terminals, BaseUnits and I/O modules for the ET 200SP distributed I/O system.

Optional markings

- The color identification labels are module-specific labels for color coding the potentials of the I/O modules. A color code (Color Code, e.g. CC01) is printed on each color identification label and I/O module. The color code allows you to read which color identification label is required for the terminals of the associated BaseUnit directly from the I/O module. The following versions of color coded labels are available:
 - Module-specific color combinations for the process terminals (see the device manuals I/O modules (<http://support.automation.siemens.com/WW/view/en/55679691/133300>)). The different colors have the following meaning: Gray = input or output signal, red = potential +, blue = ground.
 - For the AUX terminals in the colors yellow-green, blue or red
 - For the add-on terminals in the colors blue-red
- The reference identification labels (in accordance with EN 81346) can be inserted onto each CPU/interface module, BusAdapter, BaseUnit and I/O module. This makes it possible to create a fixed assignment between the reference identification label of the BaseUnit and the I/O module.

With the standard plotter setting, the reference identification label is suitable for automatic labeling with E-CAD systems.

- The labeling strips can be inserted in the CPU/interface module, I/O module and BU cover and allow identification of the ET 200SP distributed I/O system. The labeling strips can be ordered on a roll for thermal transfer printers or as DIN A4 format sheets for laser printers.



- ① Reference identification labels
- ② Labeling strips
- ③ Color identification labels

Figure 5-31 Optional markings

5.11.3 Applying color identification labels

Requirements

The BaseUnits must not be wired when you apply the color identification labels.

Required tools

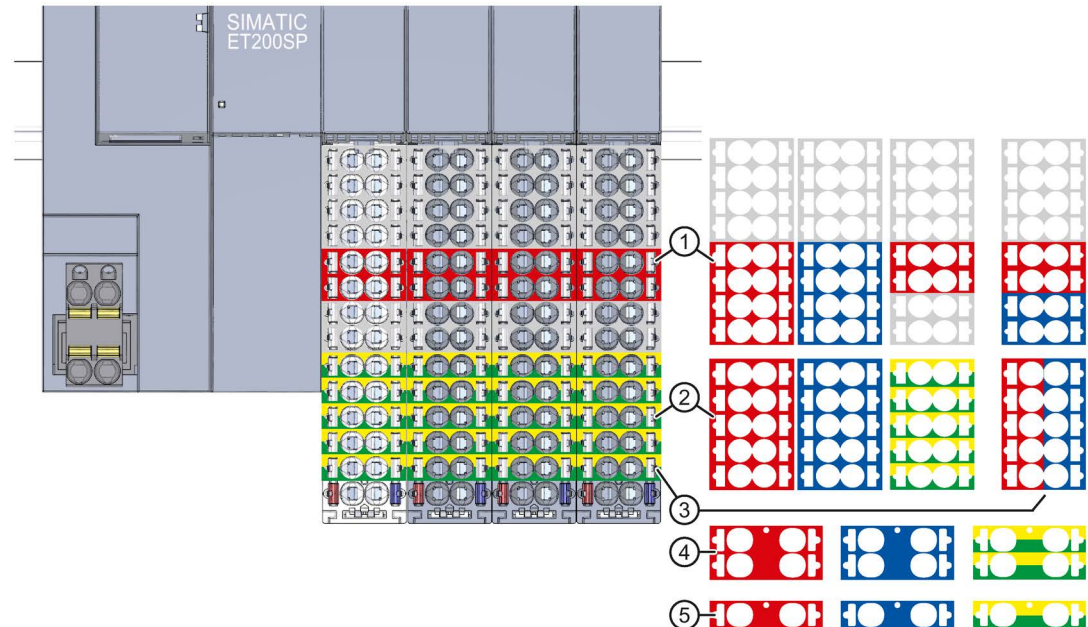
3 mm screwdriver (only for removing the color identification labels)

Applying color identification labels

Press color identification labels into the terminal box of the BaseUnit.

Note

To remove the color identification labels, you must first disconnect the wiring on the BaseUnit and then carefully lever the color identification labels out of the holder using a screwdriver.



- ① Module-specific color identification labels (15 mm) for the process terminals (see I/O module (<http://support.automation.siemens.com/WW/view/en/55679691/133300>) Manual)
- ② Color identification labels (15 mm) for the 10 AUX terminals
- ③ Color identification labels (15 mm) for the 10 add-on terminals
- ④ Color identification labels (20 mm) for the 4 AUX terminals
- ⑤ Color identification labels (20 mm) for the 2 AUX terminals

Figure 5-32 Applying color identification labels

NOTICE

AUX bus as PE bar

If you use an AUX bus as a protective conductor (PE), attach the yellow-green color identification labels to the AUX terminals.

If you stop using the AUX terminals as a protective conductor bar, remove the yellow-green color identification labels and make sure that the system is still protected.

5.11.4 Applying labeling strips

Procedure

Watch the video sequence (<http://support.automation.siemens.com/WW/view/en/95886218>)

Proceed as follows to install a labeling strip:

1. Label the strips.
2. Insert the labeling strip into the interface module or I/O module.

5.11.5 Applying reference identification labels

Procedure

Watch the video sequence (<http://support.automation.siemens.com/WW/view/en/95886218>)

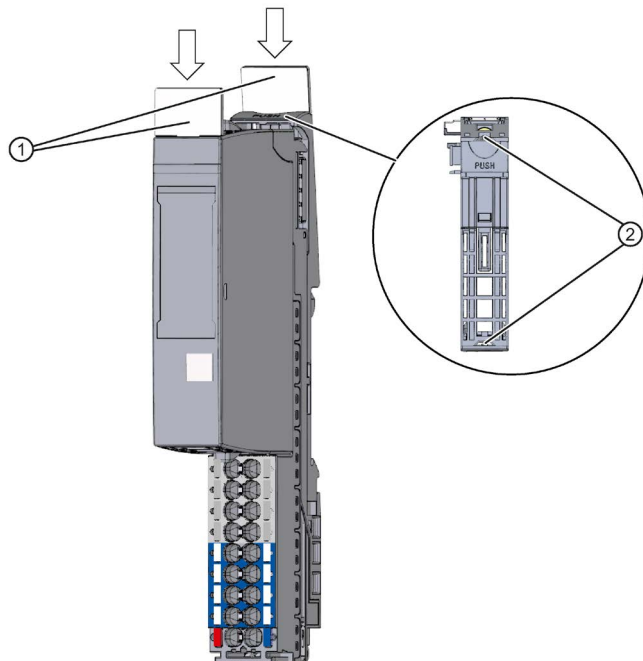
Proceed as follows to install a reference identification label:

1. Break off the reference identification labels from the sheet.
2. Insert the reference identification labels into the opening on the CPU/interface module, BusAdapter, BaseUnit and I/O module. The opening is located on the top of the BaseUnit or I/O module.

Note

Reference identification label

The printable side of the reference identification label must be facing forward.



- ① Reference identification labels
- ② Opening for label

Figure 5-33 Applying reference identification labels

Configuring

6.1 Configuring ET 200SP

Introduction

The ET 200SP distributed I/O system is configured and assigned parameters with STEP 7 (CPU/interface module, I/O modules and server module) or using configuration software of a third-party manufacturer (interface module, I/O modules and server module).

"**Configuring**" is understood to mean arranging, setting and networking devices and modules within the device or network view. STEP 7 represents modules and module racks graphically. Just like "real" module racks, the device view allows the insertion of a defined number of modules.

When the modules are plugged, STEP 7 automatically assigns the addresses and a unique hardware identifier. You can change the addresses later. The hardware identifiers cannot be changed.

When the automation system is started, the CPU/interface module compares the configured planned configuration with the system's actual configuration. You can make parameter settings to control the response of the CPU/interface module to errors in the hardware configuration.

"**Parameter assignment**" is understood to mean setting the properties of the components used. During parameter assignment, the hardware parameters are set and the settings for data exchange are made:

- Properties of the modules to which parameters can be assigned
- Settings for data exchange between components

The parameters are loaded into the CPU/interface module and transferred to the corresponding modules during startup. Modules can be replaced very easily because the set parameters are automatically loaded into the new module during startup.

Requirements for configuration of the CPU

Table 6- 1 Requirement for installing the CPU

Configuration software	Requirements	Installation information
CPU 151xSP-1 PN: STEP 7 (TIA Portal) as of V13 Update 3	<ul style="list-style-type: none"> • PROFINET IO • PROFIBUS DP (optional): with the communication module CM DP 	STEP 7 online help
CPU 151xSP F-1 PN: STEP 7 (TIA Portal) as of V13 SP1		
CPU 151xSP-1PN (as of FW version V1.8), CPU 151xSP F-1 PN (as of FW version V1.8): STEP 7 (TIA Portal) as of V13 SP1 Update 4		

Requirements for configuration of the interface module

Table 6- 2 Requirement for installing the interface module

Configuration software	Requirements	Installation information
STEP 7 (TIA Portal) as of V11 SP2*	<ul style="list-style-type: none"> • PROFINET IO: as of Support Package HSP0024 	STEP 7 online help
STEP 7 as of V5.5 SP2	<ul style="list-style-type: none"> • PROFINET IO: GSD file GSDML-Vx.y-siemens-et200sp-"Date in format yyyyymmdd".xml (http://support.automation.siemens.com/WW/view/en/19698639/130000) • PROFIBUS DP: GSD file SI0xxxxx.gsx (http://support.automation.siemens.com/WW/view/en/10805317/133300) 	Manufacturer documentation
Software of third-party manufacturer		

* The TIA Portal supports GSDML specification V2.25. The ET 200SP distributed I/O system is delivered with a GSD file based on specification V2.3. The GSD file can be installed in the TIA Portal and used without restrictions.

Configuration of the ET 200SP

See the STEP 7 online help or the documentation of the configuration software manufacturer.

Note

For I/O modules that are installed on a BaseUnit BU..D (light-colored BaseUnit), you always have to set the parameter "Potential group" to "Enable new potential group". If you do not set this parameter correctly, the CPU/interface module goes to STOP and generates a parameter error.

Note

For PROFIBUS with configuration via GSD file

In the configuration software, you must set for the BU covers whether these are on a light-colored or dark-colored BaseUnit.

6.2 Configuring the CPU

6.2.1 Reading out the configuration

Reading out the configuration of an existing station

When a connection exists to a CPU, you can load the configuration of this CPU (including possibly present modules) from the device into your project. To do this, create a new project and configure an "Unspecified CPU".



Figure 6-1 Unspecified CPU in the device view

In the device view (or in the network view), select the "Hardware detection" command in the "Online" menu.

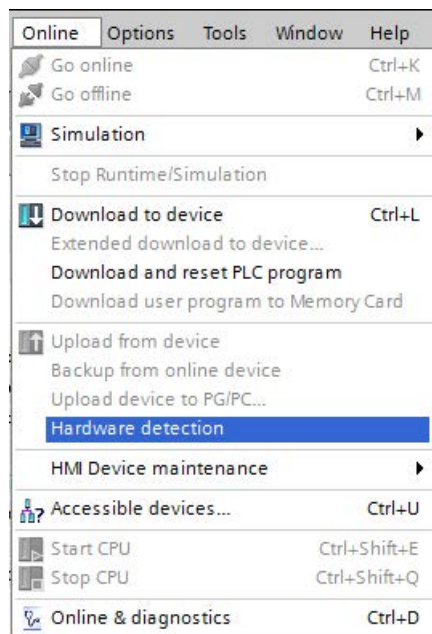


Figure 6-2 Hardware detection in the Online menu

You can also double-click the CPU and click "Detect" in the message.

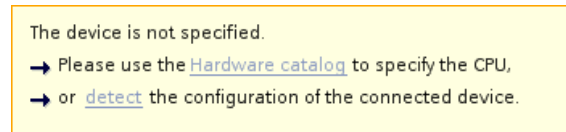


Figure 6-3 Hardware detection message in the device view

After you have selected the CPU and the PG/PC interface in the "Hardware detection for PLC_x" dialog and have clicked the "Detect" button, STEP 7 loads the hardware configuration including the modules from to the CPU into your project.

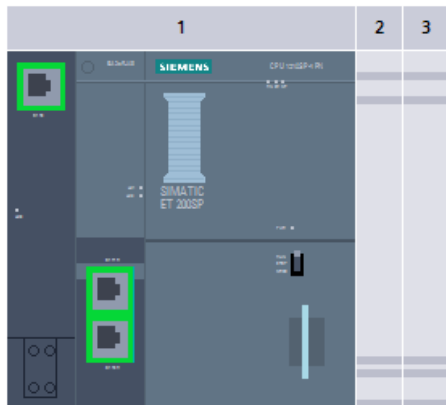


Figure 6-4 Result of the hardware detection in the device view

STEP 7 assigns a valid default parameter assignment for all modules. You can change the parameter assignment subsequently.

Properties of central modules

The properties of the CPUs have special significance for system behavior. You can set the following for a CPU using STEP 7:

- Startup behavior
- Parameter assignment of the interface(s), for example, IP address, subnet mask
- Web server, e.g. activation, user administration, and languages
- Cycle times, e.g. maximum cycle time
- System and clock memory
- Protection level for access protection with assigned password parameter
- Time-of-day settings (daylight saving time/standard time)

The properties that can be set and the corresponding value ranges are specified by STEP 7. Fields that cannot be edited are grayed out.

Reference

Information about the individual settings can be found in the online help and in the manuals of the relevant CPUs.

6.2.2 Addressing

Introduction

In order to address the automation components or I/O modules, they need unique addresses. The various address areas are explained below.

I/O address

I/O addresses (input/output addresses) are required in the user program to read inputs and set outputs.

STEP 7 automatically assigns input and output addresses when you connect the modules. Each module uses a continuous area in the input and/or output addresses corresponding to its volume of input and output data.

Module	Rack	Slot	I address	Q addr...	Type	Order no.	Firmware
▼ PLC_1	0	1			CPU 1510SP-1 PN	6ES7 510-1DJ00-0AB0	V1.6
▼ PROFINET-Schnittstelle_1	0	1 X1			PROFINET interface		
Port_1	0	1 X1 P1			Port		
Port_2	0	1 X1 P2			Port		
Port_3	0	1 X1 P3			Port		
	0	1 X2					
DI 4x120...230VAC ST_1	0	2	0		DI 4x120...230VAC ST	6ES7 131-6FD00-0BB1	V1.0
DQ 8x24VDC/0.5A ST_1	0	3		0	DQ 8x24VDC/0.5A ST	6ES7 132-6BF00-0BA0	V1.1
AI 8xRTD/TC 2-wire HF_1	0	4	1...16		AI 8xRTD/TC 2-wire ...	6ES7 134-6JF00-0CA1	V2.0
AQ 2xU/I HF_1	0	5		1...4	AQ 2xU/I HF	6ES7 135-6HB00-0CA1	V1.0

Figure 6-5 Example with input / output addresses from STEP 7

The address areas of the modules are assigned to the process image partition 0 ("Automatic updating") by default. This process image partition is updated in the main cycle of the CPU.

Device address (e.g. Ethernet address)

Device addresses are addresses of programmable modules with interfaces to a subnet (e.g., IP address or PROFIBUS address). They are required to address the various devices on a subnet, for example, to download a user program.

Hardware identifier

In addition to the I/O addresses, STEP 7 automatically assigns a hardware identifier which is used to identify the modules. A hardware identifier is also assigned to submodules.

The hardware identifier consists of an integer. It is output by the system with diagnostics alarms. The hardware identifier identifies the faulty module or the functional unit.

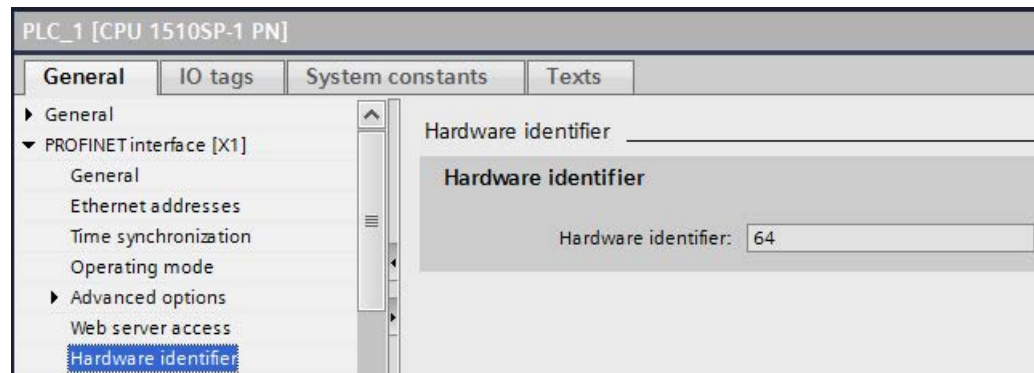


Figure 6-6 Example of a hardware identifier from STEP 7

You also use the hardware identifier for a series of instructions to identify the corresponding module for the particular instruction.

STEP 7 assigns the hardware identifier and the name of the hardware identifier automatically. It cannot be changed by the user. STEP 7 assigns the hardware identifier when you insert components in the device view or network view. The "System constants" tab includes all hardware identifiers and their names for the selected module.

The screenshot shows the 'Standard-Variablen-tabelle' (Default tag table) in STEP 7. The table lists hardware identifiers and their corresponding module names. The 'System constants' tab is selected.

	Name	Data type	Value	Comment
39	PROFINET-Schnittstelle_1	Hw_Interface	64	
40	Port_3[PN]	Hw_Interface	67	
41	Port_1[PN]	Hw_Interface	65	
42	Port_2[PN]	Hw_Interface	66	
43	OB_Main	OB_PCYCLE	1	
44	DI_4x120..230VAC_ST_1[DI]	Hw_SubModule	260	
45	DQ_8x24VDC_0.5A_ST_1[DO]	Hw_SubModule	261	
46	AI_8xRTD_TC_2-wire_HF_1[AI]	Hw_SubModule	262	
47	AQ_2xU_I_HF_1[AO]	Hw_SubModule	263	

Figure 6-7 Example of an excerpt from a default tag table in STEP 7

You will find the hardware identifiers and names of all modules in the "Default tag table" of the PLC tags. The entries in the "Default tag table" of the PLC tags cannot be changed either.

6.2.3 Process images and process image partitions

6.2.3.1 Process image - overview

Process image of the inputs and outputs

The process image is a memory area of the CPU and includes an image of the signal states of the input/output modules. At the start of the cyclic program, the CPU transfers the signal states of the input modules to the process image of the inputs. At the end of the cyclic program, the CPU transfers the process image of the outputs as a signal state to the output modules. You access this process image memory area in the user program by addressing the operand areas inputs (I) and outputs (O).

Advantages of the process image

A process image offers the advantage that you can access a consistent image of the process signals during cyclic program execution. If a signal state at an input module changes during program processing, the signal state is retained in the process image. The process image is not updated until the next cycle.

You can only assign the addresses of a module to a single process image partition.

32 process image partitions

The overall process image is subdivided into up to 32 process image partitions (PIP).

The user program updates the PIP 0 in each program cycle (automatic update). The PIP 0 is assigned to OB 1.

You can assign the process image partitions PIP 1 to PIP 31 to the other OBs during configuration of the input/output modules in STEP 7.

6.2.3.2 Automatically updating process image partitions

You can assign one process image partition to each organization block. In this case, the user program automatically updates the process image partition. The exceptions are PIP 0 and isochronous OBs.

Updating the process image partition

The process image partition is divided into two parts:

- Process image partition of the inputs (PIPI)
- Process image partition of the outputs (PIPQ)

The CPU always updates/reads the process image partition of the inputs (PIPI) before processing of the associated OB. The CPU outputs the process image of the outputs (PIPQ) at the end of the OB.

The figure below illustrates the updating of the process image partitions.

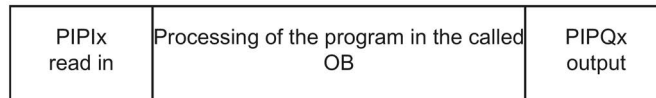


Figure 6-8 Updating process image partitions

6.2.3.3 Update process image partitions in the user program

As an alternative to the automatic updating of process image partitions, you can update process images with the "UPDAT_PI" instruction or the "UPDAT_PO" instruction. In STEP 7, these instructions are available on the "Instructions" task card under "Extended instructions". They can be called from any point in the program.

Requirements for updating process image partitions with the "UPDAT_PI" and "UPDAT_PO" instructions:

- The process image partitions are not allowed to be assigned to any OB, which means they are not allowed to be automatically updated.
- PIP 0 (automatic update) can likewise not be updated with the "UPDAT_PI" and "UPDAT_PO" instructions.

UPDAT_PI: Update the process image partition of the inputs

With this instruction you read the signal states from the input modules into the process image partition of the inputs (PIPI).

UPDAT_PO: Update the process image partition of the outputs

With this instruction you transfer the process image partition of the outputs to the output modules.

Direct I/O access to the inputs and outputs of the module

You also have direct read and write access to the I/O, as an alternative to access via the process image, should direct access be required for programming reasons.

Reference

Additional information on process image partitions is available in the function manual, Cycle and response times (<http://support.automation.siemens.com/WWW/view/en/59193558>).

6.2.4 Backing up and restoring the CPU configuration

6.2.4.1 Overview

Backup from online device

You will make a number of changes to your plant over time, for example, add new devices, replace existing devices or adapt the user program. If these changes result in undesirable behavior, you can restore the plant to an earlier state. Before you load a changed configuration to the CPU, first use the option "Backup from online device" to create a complete backup of the current device status.

Upload from device (software)

With the option "Upload from device (software)", you load the software project data from the CPU to an existing CPU in the project.

Upload device as new station

If you are operating a new programming device/PC in the plant, the STEP 7 project that was used to create the plant configuration might not be available. In this case you can use the option "Upload device as new station" to load the device's data into a project in your PG/PC.

Snapshot of the monitor values

You can use the option "Snapshot of the monitor values" to backup the current values of the data block, in order to be able to restore the current values if necessary at a later date.

Overview of backup types

The table below shows the backup of CPU data depending on the selected type of backup and its specific characteristics:

	Backup from online device	Upload from device (software)	Upload device as new station	Snapshot of the monitor values
Actual values of all DBs (global and instance data blocks)*	✓	✓	✓	✓
Blocks of the type OB, FC, FB and DB	✓	✓	✓	--
PLC tags (tag names and constant names)	✓	✓	✓	--
Technology objects	✓	✓	✓	--
Hardware configuration	✓	--	✓	--
Actual values (bit memories, timers, counters)*	✓	--	--	--
Contents of the SIMATIC memory card	✓	--	--	--
Archives, recipes	✓	--	--	--
Entries in the diagnostics buffer	--	--	--	--
Current time	--	--	--	--
Properties of the type of backup				
Backup possible for fail-safe CPUs	✓	--	--	✓
Backup can be edited	--	✓	✓	✓
Backup possible in operating mode	STOP	RUN, STOP	RUN, STOP	RUN, STOP

* Only the values of the tags that are set as retentive are backed up

6.2.4.2 Backup from online device

Full backup of the CPU

With the option "Backup from online device" you create a full backup of the CPU in an opened project with STEP 7. The following data are backed up:

- Actual values of all DBs
- Blocks of the type OB, FC, FB and DB
- PLC tags
- Technology objects
- Hardware configuration
- Actual values (bit memories, timers, counters)
- Contents of the SIMATIC memory card
- Archives, recipes

Note

Backup of current values

The "Backup from online device" type of backup backs up the current values of the tags that are set as retentive. To ensure consistency of the retentive data, all write access to retentive data must be disabled during the backup.

Actual values of the non-retentive data are reset to their start values during a transition for STOP to RUN mode. When the CPU is backed up only these start values of non-retentive data are then backed up.

Requirements

The following requirements must be met before you start the backup:

- The CPU has been set up in the project.
- The CPU is connected to the programming device/PC via the PROFINET interface. Interfaces of CMs/CPs are not supported.
- The CPU must be in STOP mode.
- The hardware configuration and software to be downloaded have to be compatible with STEP 7.
- You have the password for read access to the CPU or F-CPU, if an access level was configured for the CPU or F-CPU.

Procedure

To create a backup of the current configuration of a CPU, follow these steps:

1. Select the PLC station in the project tree.
2. Select the "Backup from online device" command in the "Online" menu.
You may have to enter and confirm the password for read access and confirm that the CPU may be set to STOP mode.

Result

STEP 7 backs up the CPU saves the backup in the "Name of CPU > Online backups" folder in the project tree. The backup is assigned the name of the CPU with the time and date of the backup. You can rename the backup, but you cannot make any changes to the contents of the backup.

An entry is created for each backup operation in the diagnostics buffer of the CPU.

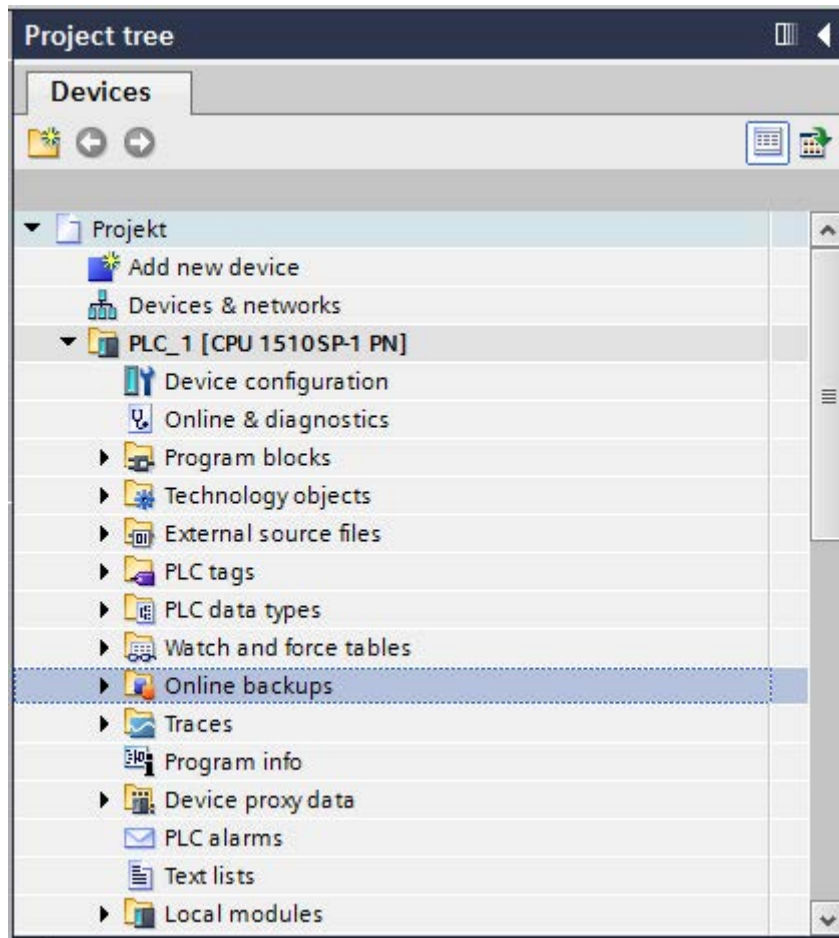


Figure 6-9 "Online backups" folder in the project tree of STEP 7

You can create as many backups as you want and store a variety of configurations for a CPU.

Restoring a full backup

You can transfer to the CPU a backup made at an earlier date. The CPU restores the saved data.

Requirements

The following requirements must be met before you start the restore:

- You have previously configured the CPU and stored a backup of the device in the project.
- The CPU is connected to the programming device/PC via the PROFINET interface.
- The CPU must be in STOP mode.
- You have the password for read access to the CPU, if an access level was configured for the CPU.

Procedure

To restore the data on the CPU, follow these steps:

1. Open up the folder of the device in the project tree to display the lower-level objects.
2. Open the "Online backups" folder.
3. Select the backup you want to restore.
4. In the "Online" menu, select the "Download to device" command (you may need to enter the password for read access to the CPU)
 - If you had previously established an online connection, the "Load preview" dialog opens. The dialog includes alarms and suggests necessary actions for the download.
 - If you have not already established an online connection, the "Extended download to device" dialog opens automatically. In it, select the interfaces with which you want to establish the online connection to the device.
5. Check the alarms in the "Load preview" dialog, and select the actions in the "Action" column, if necessary.

 **WARNING**

Download of backups with unknown content

If you activate the suggested actions during download and during plant operation, malfunctions or program errors can cause severe damage and serious injuries.

Make sure that the backup contents do not include any configuration that would result in unpredictable behavior of the plant.

6. As soon as downloading becomes possible, the "Load" button is enabled.
7. Click "Load".
The contents of the backup are transferred to the CPU and restored. The CPU is restarted.

The "Load results" dialog opens. In this dialog, you can check whether or not the loading operation was successful and take any further action that may be necessary.
8. Click "Finish".

6.2.4.3 Upload from device (software)

Loading software project data from the CPU to a project

With the option "Upload from device (software)" you back up the software components from the CPU to a project. The option uploads the following data from the CPU to a project:

- Actual values of all DBs
- Blocks of the type OB, FC, FB and DB
- PLC tags
- Technology objects

Requirements

Before you start with the uploading of the data from the CPU to a project, the following requirements must be met:

- The CPU has been set up in the project.
- The CPU is connected to the programming device/PC via the PROFINET interface. Interfaces of CMs/CPs are also supported.
- The CPU is online.
- The software components that are to be loaded must be compatible with STEP 7.
- The CPU is in STOP or RUN mode.

Procedure

To upload the data to a project, follow these steps:

1. Select the required PLC station in the project tree.
2. In the "Online" menu, select the "Upload from device (software)" command.
3. In the "Upload preview" dialog window, select the check box "Continue".
4. Click the "Upload from device" button.

Upload blocks from the CPU to a project

You use this option to load blocks from the CPU back to the offline project.

The following requirements must be met before you start to backup the blocks:

- The project associated with the user program is open.
- The CPU has been set up in the project.
- The CPU is connected to the programming device/PC via the PROFINET interface. Interfaces of CMs/CPs are also supported.
- The CPU is online.
- The blocks that are to be loaded must be compatible with STEP 7.
- The CPU is in STOP or RUN mode.

To upload all blocks from the CPU to a project, select the "Program blocks" folder in the project tree. In the "Online" menu, select the "Upload from device (software)" command.

To upload an individual block, select the required block in the "Program blocks" folder. In the "Online" menu, select the "Upload from device (software)" command.

When a block is uploaded, the start values from the load memory of the CPU is transferred as start value in the offline version of the project.

A block is only uploaded from the CPU to a project if the online version of the block differs from the offline version of the block in the project.

After you have completed the backup of blocks from the CPU, you can perform the required changes offline and transfer the block to the CPU again. To do so, proceed as described in the following section.

Upload blocks from a project to the CPU

To upload one or multiple blocks to the CPU, select the "Program blocks" folder in the project tree. Select the "Download to device" > "Software (only changes)" command from the shortcut menu. Alternatively, select the "Download to device" command in the "Online" menu.

The block or blocks is/are compiled consistently. The download is terminated if an error occurs during compiling. You can only load blocks that are compiled without errors.

Note

Loading external objects

If you load blocks to the CPU which contain references to objects (other DBs, FCs, FBs, system constants, global tags) outside the project, these blocks cannot be compiled without errors.

 WARNING
--

Reloading blocks while the plant is operating
--

Reloading blocks while the plant is operating can cause serious damage to property or injury to persons if there are functional disturbances or program errors. Make sure that no dangerous situations can arise before you start the actions.
--

6.2.4.4 Upload device as new station

Upload device as new station (hardware and software)

With this option you upload existing project data of a CPU to your project as a new station. The option can be used, for example, to save the project data of a new plant as a new project in your programming device/PC. "Upload device as new station (hardware and software)" loads the following data from the CPU to your project:

- Actual values of all DBs
- Blocks of the type OB, FC, FB and DB
- PLC tags
- Technology objects
- Hardware configuration

Note

The type of the BaseUnit (light or dark) is not currently recognized. You need to adjust the parameters in the properties.

Requirements

The following requirements must be met before you can execute the option:

- The CPU is connected to the programming device/PC via the PROFINET interface. Interfaces of CMs/CPs are also supported.
- The hardware configuration and software to be uploaded to the device must be compatible with STEP 7.
- Modules present in the device from GSD (ML), HSPs, or service packs must be installed in STEP 7 on the programming device/PC.
- A project must be open. This project can be a new (empty) project or an existing project.

Note

Upload device as new station to an existing project

When you upload a device as new station to an existing project, make sure there are no conflicts between the name of the existing components and the components to be uploaded, for example, the name of the CPU is already used in the existing project.

If conflicts exist, follow these steps:

- Change the names/IP addresses used in the project.
 - Compile the affected stations.
 - Re-start the function Upload device as new station (hardware and software)".
-

Procedure

To upload CPU to your project, follow these steps:

1. Select the project name in the project tree.
2. In the "Online" menu, select the "Upload the device as new station (hardware and software)".
The "Upload device to PG/PC" dialog is opened.
3. Choose required interface type in the "Type of PG/PC interface" drop-down list.
4. Select the interface to be used from the "PG/PC interface" drop-down list.
5. Click the "Configure interface" button to the right of the "PG/PC interface" drop-down list to adapt the settings for the selected interface.
6. Display all compatible devices by selecting the relevant option and clicking the "Start search" command. In the accessible devices table, select the device from which you want to upload project data.
7. Click "Load".

6.2.4.5 Snapshot of the monitor values

Backing up actual values of all data blocks

With the option "Snapshot of the monitor values" you overwrite the start values of tags in the offline version of a data block with actual values from the CPU. In this way, you can restore the backed up status of the data blocks at a later date after changing the actual values.

To apply the actual values, you first generate a snapshot of tag values from the online program. You can then apply them to the offline program.

Note

Note that the values from the snapshot are always copied. STEP 7 does not hereby check whether all values originate from the same cycle.

The following options exist for the application of actual values from the snapshot as start values:

- Apply the values of an opened data block
You can apply all values or only the values of the tags marked as a "Set value" as start values in an open data block.
- Apply the values of multiple blocks in the project tree
In the project tree, you can apply all set values or all retentive values as start values.

The following requirements must be met in order to be able to back up the actual values of data blocks:

- The CPU is connected to the programming device/PC via the PROFINET interface. Interfaces of CMs/CPs are also supported.
- The CPU is online.
- As least one data block has been loaded to the CPU.
- The data blocks are not write-protected.

Apply monitored values

To apply all actual values or only the values that are marked as "set value" tags in a data block, follow these steps:

1. Open the data block.
2. Start the monitoring by clicking the "Monitor all" button.
The "Monitor value" column is shown in the table. This shows the actual data values.
3. On the toolbar, click "Snapshot of the monitor values".
The actual monitor values are applied in the "Snapshot" column. Note here that the monitor values can originate from various program cycles.


The following options exist to apply the actual values from the snapshot as start value in the offline version of the data block.

- **Apply individual start value**
To apply an individual value as start value, select the value in the "Snapshot" column. Use the "Copy" and "Paste" commands from the shortcut menu to copy the values and paste them in the "Start value" column.
- **Apply all values**
To apply all values, click the "Copy all values from the "Snapshot" column to the "Start value" column" button in the toolbar.
- **Apply setpoint values**
To apply setpoint values, click the "Copy all setpoints from the "Snapshot" column to the "Start value" column" button in the toolbar. The selected setpoint values from the column "Snapshot" are applied as start values.
- **Apply the actual values of retentive data tags**
To apply only the actual values of retentive data tags as start values, select the data block in the project tree. In the shortcut menu, select the commands "Snapshot of monitor values" and "Apply monitor values as start values" > "Only retain values".
- **Apply actual values of multiple data blocks as start values**
To apply the actual values of multiple data blocks as start values, select the data blocks in the project tree. Select the "Snapshot of monitor values" command in the shortcut menu. In the shortcut menu "Apply monitor values as start values" > "Only setpoints" or "Apply monitor values as start values" > "Only retain values".

6.2.4.6 Overwrite actual values of a block with snapshot values

Overwrite actual values with a snapshot

With the option "Copy all values from the snapshot to the actual values of the CPU" you overwrite the actual values of a data block with momentary values. The values from the snapshot are then written to the CPU work memory. The CPU then uses these values as actual values in the online program.

 WARNING
Changes to tag values
Changing the tag values while the plant is operating can cause serious damage to property or injury to persons if there are functional disturbances or program errors!
<ul style="list-style-type: none">• Make sure that the plant is in a safe state before you overwrite the actual values.• Make sure that the program does not read or write the affected data during transmission.• You may want to use the "Modify tags" function in the watch table or in the DB editor as an alternative.

Requirement

The following requirements must be met before you can execute the option:

- The CPU is connected to the programming device/PC via the PROFINET interface. Interfaces of CMs/CPs are also supported.
- The CPU is online.
- As least one block has been loaded to the CPU.

Procedure

To overwrite the actual values of a block with a snapshot, follow these steps:

1. Open the data block.
2. Start the monitoring by clicking the "Monitor all" button.
The "Monitor value" column is shown in the table. This shows the actual data values.
3. On the toolbar, click "Snapshot of the monitor values".
The actual monitor values are applied in the "Snapshot" column. Note here that the monitor values can originate from various program cycles.
4. To apply the values, click "Copy all values from the snapshot to the actual values of the CPU" on the toolbar.

Dependency on the CPU mode

You can execute this function in "RUN" mode as well as in "STOP" mode. The table below shows the reactions of the CPU in the different modes:

Table 6- 3 Reaction of the CPU depending on the mode

Action	System reaction	Consequences for the online program
Overwrite actual values in "RUN" mode	The values of all data block tags are overwritten during operation. No distinction is made between retentive and non-retentive values.	Changing actual values can lead to inconsistencies between the program and the actual process. If the volume of data to be transmitted is large, the values are possibly transmitted in several cycles. If the program accesses tags before all values are completely transmitted, there is a risk that inconsistent value combinations may be created and processed. The copying of the values of elementary data types can also possibly take place over several cycles. These values are potentially invalid until they have been completely transmitted. Dangerous states may occur if the program accesses these values before they have been completely transmitted.
Overwrite actual values in "STOP" mode	Only the actual values of the retentive tags are overwritten by the snapshot. Non-retentive tags are initialized with their start values during the transition from STOP to RUN. The values from the snapshot are not taken into consideration.	Because only the data from the snapshot are transmitted, there is a risk that inconsistent value combinations may be created and processed.

6.3 Configuring the interface module

Configuring

Read the STEP 7 online help and/or the documentation of the configuration software manufacturer when configuring the interface module.

6.4 Assignment of the F-destination address for fail-safe modules

The F-destination address is saved permanently on the coding element of the ET 200SP fail-safe modules.

Note

The supply voltage L+ must be applied to the F-module when the F-destination address is assigned.

Note

Note the following in conjunction with configuration control:

Before you can use configuration control together with F-modules, you must assign the F-destination address to the F-modules at the designated slots. For this, each F-module must be inserted in the slot configured for it. The actual configuration can then differ from the specified configuration.

For additional information on assigning the F-destination address, refer to the SIMATIC Safety - Configuring and Programming (<http://support.automation.siemens.com/WW/view/en/54110126>) Programming and Operating Manual and to the online help for the *S7 Configuration Pack*.

Basics of program execution

7.1 Events and OBs

Response to triggers

The occurrence of a start event results in the following reaction:

- If the event comes from an event source to which you have assigned an OB, this event triggers the execution of the assigned OB. The event is positioned in a queue according to its priority.
- If the event comes from an event source to which you have not assigned an OB, the CPU executes the default system reaction.

Note

Some event sources, such as startup, pull/plug, exist even if you do not configure them.

The table below provides an overview of the start events, including the possible values for OB priority, possible OB numbers, default system reaction and number of OBs. The table is sorted in ascending order by OB numbers.

Types of event sources	Possible priorities (default priority)	Possible OB numbers	Default system reaction*	Number of OBs
Startup**	1	100, ≥ 123	Ignore	0 to 100
Cyclic program**	1	1, ≥ 123	Ignore	0 to 100
Time-of-day interrupt**	2 to 24 (2)	10 to 17, ≥ 123	Not applicable	0 to 20
Time-delay interrupt**	2 to 24 (3)	20 to 23, ≥ 123	Not applicable	0 to 20
Cyclic interrupt**	2 to 24 (8 to 17, frequency dependent)	30 to 38, ≥ 123	Not applicable	0 to 20
Hardware interrupt**	2 to 26 (18)	40 to 47, ≥ 123	Ignore	0 to 50
Status interrupt	2 to 24 (4)	55	Ignore	0 or 1
Update interrupt	2 to 24 (4)	56	Ignore	0 or 1
Manufacturer-specific or profile-specific interrupt	2 to 24 (4)	57	Ignore	0 or 1
Synchronous cycle interrupt	16 to 26 (21)	61 to 64, ≥ 123	Ignore	0 to 2
Time error***	22	80	Ignore	0 or 1
Cycle monitoring time exceeded once			STOP	
Diagnostics interrupt	2 to 26 (5)	82	Ignore	0 or 1
Pull/plug interrupt for modules	2 to 26 (6)	83	Ignore	0 or 1
Rack error	2 to 26 (6)	86	Ignore	0 or 1
MC servo interrupt	17 to 26 (25)	91	Not applicable	0 or 1

Types of event sources	Possible priorities (default priority)	Possible OB numbers	Default system reaction*	Number of OBs
MC interpolator interrupt	16 to 26 (24)	92	Not applicable	0 or 1
Programming error (only for global error handling)	2 to 26 (7)	121	STOP	0 or 1
I/O access error (only for global error handling)	2 to 26 (7)	122	Ignore	0 or 1

* If OB was not configured

** For these event sources, apart from the permanently assigned OB numbers (see column: possible OB numbers), you can also assign OB numbers in STEP 7 from the range ≥ 123 .

*** If the cycle monitoring time is exceeded twice within a cycle, the CPU always switches to STOP, regardless of whether OB80 was configured.

Assignment between event source and OBs

The type of OB determines where you make the assignment between OB and event source:

- With hardware interrupts and isochronous mode interrupts, the assignment is made during the configuration of the hardware or when the OB is created.
- STEP 7 automatically assigns OBs 91/92 to the MC servo interrupt and MC interpolator interrupt as soon as you add a technology object.
- For all other types of OB, the assignment is made when the OB is created, where applicable after you have configured the event source.

For hardware interrupts, you can change an assignment which has already been made during runtime with the instructions ATTACH and DETACH. In this case, only the actually effective assignment changes, and not the configured assignment. The configured assignment takes effect after loading, and at startup.

The CPU ignores hardware interrupts to which you did not assign an OB in your configuration or which occur after the DETACH instruction. The check as to whether an OB is assigned to an event does not take place when the associated event occurs, but only when the hardware interrupt actually has to be executed.

OB priority and runtime behavior

If you have assigned an OB to the event, the OB has the priority of the event. The CPU supports the priority classes 1 (lowest priority) to 26 (highest priority). The following items are essential to the processing of an event:

- The call of the assigned OB
- The update of the process image partition of the assigned OB
- The processing of the assigned OB.

The user program processes the OBs exclusively on a priority basis. This means the program processes the OB with the highest priority first when multiple OB requests occur at the same time. If an event occurs that has a higher priority than the currently active OB, this OB is interrupted. The user program processes events of the same priority in order of occurrence.

Note

Communication

Communication always has priority 15; always assign a priority >15 so that the OBs are not interrupted by the communication.

Reference

You can find more information on organization blocks in the STEP 7 online help.

7.2 CPU overload behavior

Requirement

For the event scenarios considered in the following section, we assume that you have assigned an OB to each event source and that these OBs have the same priority. The second condition, in particular, is only for the sake of a simplified representation.

Principle of CPU overload behavior

An occurring event triggers the execution of the associated OB. Depending on the OB priority and the current processor load, a time delay may occur before the OB is executed when there is an overload. The same event can therefore occur once or several times before the user program processes the OB belonging to the preceding event. The CPU treats such a situation as follows: The operating system positions the events in the order of their occurrence into the queue for their priority level.

To control temporary overload situations, you can limit the number of pending events that are linked from the same source. The next event is discarded as soon as the maximum number of pending start events of a specific cyclic interrupt OB, for example, is reached.

An overload occurs when events which originate from the same source occur faster than they can be processed by the CPU.

More detailed information is available in the following sections.

Discarding similar events or handling them later

Below, the term "similar events" refers to events from a single source, such as triggers for a specific cyclic interrupt OB.

The OB parameter "Events to be queued" is used to specify how many similar events the operating system places in the associated queue and therefore post-processes. If this parameter has the value 1, for example, exactly one event is stored temporarily.

Note

The post-processing of cyclic events is often undesirable, as this can lead to an overload with OBs of the same or lower priority. Therefore, it is generally advantageous to discard similar events and to react to the overload situation during the next scheduled OB processing. If the value of the "Events to be queued" parameter is low, this ensures that an overload situation is defused rather than aggravated.

If the maximum number of start events is reached in the queue for a cyclic interrupt OB (Cyclic interrupt), for example, each additional start event is only counted and subsequently discarded. During the next scheduled execution of the OB, the CPU provides the number of discarded start events in the "Event_Count" input parameter (in the start information). You can then react appropriately to the overload situation. The CPU then sets the counter for lost events to zero.

If the CPU discards a start event for a cyclic interrupt OB the first time, its further behavior depends on the OB parameter "Report event overflow into diagnostics buffer": If the check box is selected, the CPU enters the event DW#16#0002:3507 once in the diagnostics buffer for the overload situation at this event source. The CPU suppresses additional diagnostics buffer entries of the event DW#16#0002:3507 that refer to this event source until all events from this source have been post-processed.

Threshold mechanism for time error OB request

The cyclic interrupt OB parameter "Enable time error" is used to specify whether the time error interrupt should be called when a specific overload level is reached for similar events. You can find the OB parameter "Enable time error" in the properties of the OB in the "Attributes" category.

If you activate the time error OB (check box selected), use the OB parameter "Event threshold for time error" to specify the number of similar events in the queue from which the user program is to call the time error interrupt. If this parameter has the value 1, for example, the CPU enters the event DW#16#0002:3502 once in the diagnostics buffer and requests the time error OB when the second event occurs. The CPU suppresses additional diagnostics buffer entries of the event DW#16#0002:3502 until all events from this source have been post-processed.

In the event of an overload, you therefore have the option of programming a reaction well before the limit is reached for similar events and thus before the events are discarded.

The following value range applies to the "Event threshold for time error" parameter: $1 \leq \text{"Event threshold for time error"} \leq \text{"Events to be queued"}$.

7.3 Asynchronous instructions

Difference between synchronous/asynchronous instructions

In program processing, a differentiation is made between synchronous and asynchronous instructions.

The "synchronous" and "asynchronous" properties relate to the temporal relationship between the call and execution of the instruction.

The following applies to synchronous instructions: When the call of a synchronous instruction is ended, the execution is also ended.

This is different in the case of asynchronous instructions: When the call of an asynchronous instruction is ended, the execution of the asynchronous instruction is not necessarily ended yet. This means the execution of an asynchronous instruction can extend over multiple calls. The CPU processes asynchronous instructions in parallel with the cyclic user program. Asynchronous instructions occupy resources in the CPU while they are being processed.

Asynchronous instructions are usually instructions for transferring data (data records for modules, communication data, diagnostics data).

Processing of asynchronous instructions

The figure below shows the difference between processing an asynchronous instruction and processing a synchronous instruction. In this figure the asynchronous instruction is called five times before the execution is completed, for example, a data record is completely transferred.

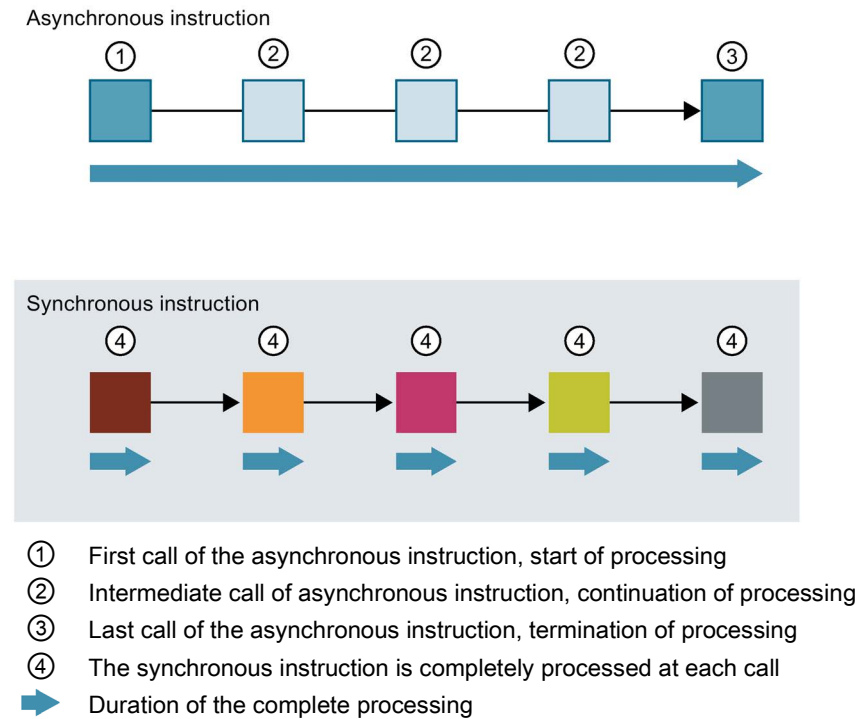


Figure 7-1 Difference between synchronous and asynchronous instructions

Parallel processing of asynchronous instruction jobs

A CPU can process several asynchronous instruction jobs in parallel. The CPU processes the jobs in parallel under the following conditions:

- Several asynchronous instruction jobs are called at the same time.
- Sufficient resources are available in the CPU.

The figure below shows the parallel processing of two jobs of the instruction WRREC. The two instructions are processed in parallel for a specific period here.

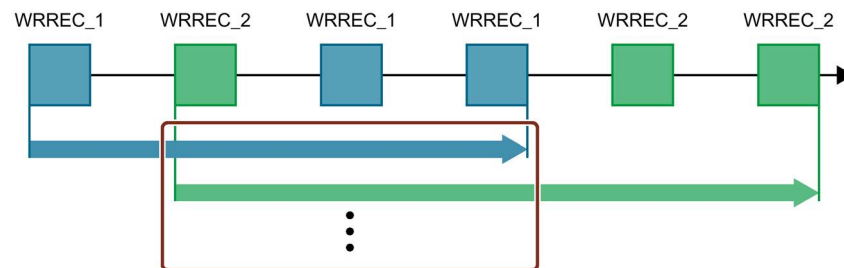


Figure 7-2 Parallel processing of the asynchronous instruction WRREC

Assignment of call to job of the instruction

To execute an instruction over multiple calls, the CPU must be able to uniquely assign a subsequent call to a running job of the instruction.

To assign a call to a job, the CPU uses one of the following two mechanisms, depending on the type of the instruction:

- The instance of the instruction (with type "SFB")
- The input parameters of the instruction identifying the job. These input parameters must match in each call during processing of the asynchronous instruction.
Example: A "Create_DB" instruction job is identified by the input parameters LOW_LIMIT, UP_LIMIT, COUNT, ATTRIB and SRCBLK.

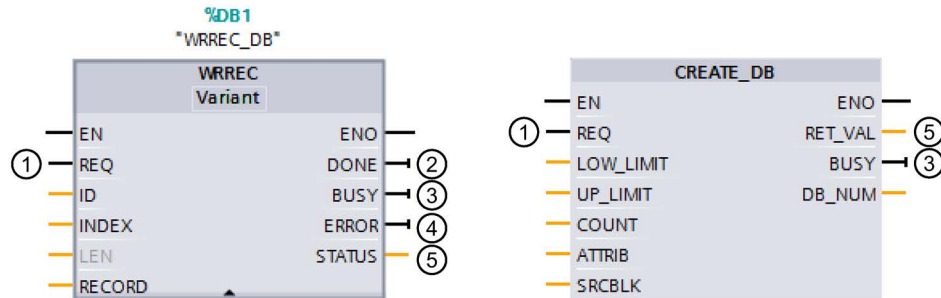
The following table shows which instruction you can identify with which input parameters.

Instruction	Job is identified by
DPSYC_FR	LADDR, GROUP, MODE
D_ACT_DP	LADDR
DPNRM_DG	LADDR
WR_DPARM	LADDR, RECNUM
WR_REC	LADDR, RECNUM
RD_REC	LADDR, RECNUM
CREATE_DB	LOW_LIMIT, UP_LIMIT, COUNT, ATTRIB, SRCBLK
READ_DBL	SRCBLK, DSTBLK
WRIT_DBL	SRCBLK, DSTBLK
RD_DPARA	LADDR, RECNUM
DP_TOPOL	DP_ID

Status of an asynchronous instruction

An asynchronous instruction shows its status via the block parameters STATUS/RET_VAL and BUSY. Many asynchronous instructions also use the block parameters DONE and ERROR.

The figure below shows the two asynchronous instructions WRREC and CREATE_DB.



- ① The input parameter REQ starts the job to execute the asynchronous instruction.
- ② The output parameter DONE indicates that the job was completed without error.
- ③ The output parameter BUSY indicates whether the job is currently being processed. When BUSY = 1, a resource is assigned for the asynchronous instruction. If BUSY = 0, then the resource is free.
- ④ The output parameter ERROR indicates that an error has occurred.
- ⑤ The output parameter STATUS/RET_VAL provides information on the status of the job execution. The output parameter STATUS/RET_VAL receives the error information after the occurrence of an error.

Figure 7-3 Block parameters of asynchronous instructions using the instructions WRREC and CREATE_DB as examples.

Summary

The table below provides you with an overview of the relationships described above. It shows in particular the possible values of the output parameters if processing is not completed after a call.

Note

Following every call, you must evaluate the relevant output parameters in your program.

Relationship between REQ, STATUS/RET_VAL, BUSY and DONE during a "running" job.

Seq. no. of the call	Type of call	REQ	STATUS/RET_VAL	BUSY	DONE	ERROR
1	First call	1	W#16#7001	1	0	0
			Error code (for example, W#16#80C3 for lack of resources)	0	0	1
2 to (n - 1)	Intermediate call	Not relevant	W#16#7002	1	0	0
n	Last call	Not relevant	W#16#0000, if no errors have occurred.	0	1	0
			Error code, if errors have occurred	0	0	1

Consumption of resources

Asynchronous instructions occupy resources in the CPU while they are being processed. The resources are limited depending on the type of CPU and instruction; the CPU can only process a maximum number of asynchronous instruction jobs simultaneously. The resources are available again after a job has been successfully completed or processed with an error.

Example: The instructions RDREC and WRREC can each be called 10 times with different instances. The number of parallel running jobs per instruction is therefore limited to 10.

If the maximum number of simultaneous jobs for an instruction is exceeded, the instruction returns the error code 80C3 (lack of resources) in the block parameter STATUS. The execution of the job is stopped until a resource becomes free again.

Note

Lower-level asynchronous instructions

Several asynchronous instructions use one or more lower-level asynchronous instructions for their processing. This dependence is shown in the tables below.

Please note that with multiple lower-level instructions, only one lower-level resource is typically occupied.

Extended instructions: Maximum number of asynchronous instructions

The following table shows the maximum number of simultaneously running instances for asynchronous extended instructions.

Extended instructions	CPU 1510SP-1 PN CPU 1510SP F-1 PN	CPU 1512SP-1 PN CPU 1512SP F-1 PN
Distributed I/O		
RDREC RD_REC		10
WRREC WR_REC		10
D_ACT_DP		8
ReconfigIOSystem	uses RDREC, WRREC, D_ACT_DP,	
DPSYC_FR		2
DPNRM_DG		8
DP_TOPOL		1
ASI_CTRL	uses RDREC, WRREC	
PROFenergy		
PE_START_END	uses RDREC, WRREC	
PE_CMD	uses RDREC, WRREC	
PE_DS3_Write_ET200S	uses RDREC, WRREC	
PE_WOL	uses RDREC, WRREC, TUSEND, TURCV, TCON, TDISCON	
Module parameter assignment		
RD_DPAR		10
RD_DPARA		10
RD_DPARM		10
WR_DPARM		10
Diagnostics		
Get_IM_Data		10
GetStationInfo		10
Recipes and data logging		
RecipeExport		10
RecipeImport		10
DataLogCreate		10
DataLogOpen		10
DataLogWrite		10
DataLogClear		10
DataLogClose		10
DataLogDelete		10
DataLogNewFile		10
Data block functions		
CREATE_DB		10
READ_DBL		10
WRIT_DBL		10
DELETE_DB		10

Basic instructions: Maximum number of asynchronous instructions

The following table shows the maximum number of simultaneously running instances for asynchronous basic instructions

Basic instructions	CPU 1510SP-1 PN CPU 1510SP F-1 PN	CPU 1512SP-1 PN CPU 1512SP F-1 PN
Array DB		
ReadFromArrayDBL	uses READ_DBL (see Extended instructions)	
WriteToArrayDBL	uses READ_DBL, WRIT_DBL (see Extended instructions)	

Communication: Maximum number of asynchronous instructions

The following table shows the maximum number of simultaneously running jobs for asynchronous instructions (Open User Communication) for the various CPUs.

Open User Communication	CPU 1510SP-1 PN CPU 1510SP F-1 PN	CPU 1512SP-1 PN CPU 1512SP F-1 PN
TSEND TUSEND	64	88
TRCV TURCV	64	88
TCON	64	88
TDISCON	64	88
T_RESET	64	88
T_DIAG	64	88
T_CONFIG	1	
TSEND_C	uses TSEND, TUSEND, TRCV, TCON, TDISCON	
TRCV_C	uses TSEND, TUSEND, TRCV, TURCV, TCON, TDISCON	
TMAIL_C	uses TSEND, TUSEND, TRCV, TURCV, TCON, TDISCON	

The following table shows the maximum number of simultaneously running jobs for asynchronous instructions (MODBUS TCP) for the various CPUs.

MODBUS TCP	CPU 1510SP-1 PN CPU 1510P F-1 PN	CPU 1512SP-1 PN CPU 1512SP F-1 PN
MB_CLIENT	uses TSEND, TUSEND, TRCV, TURCV, TCON, TDISCON	
MB_SERVER	uses TSEND, TUSEND, TRCV, TURCV, TCON, TDISCON	

The table below shows the maximum number of simultaneously running jobs for asynchronous instructions (S7 communication) for the various CPUs. The S7 communication instructions use a common pool of resources.

S7 communication	CPU 1510SP-1 PN CPU 1510SP F-1 PN	CPU 1512SP-1 PN CPU 1512SP F-1 PN
PUT GET USEND URCV BSEND BRCV	192	264

The following table shows the maximum number of simultaneously running jobs for asynchronous instructions (communication processors) for the various CPUs.

Communications processors	CPU 1510SP-1 PN CPU 1510SP F-1 PN	CPU 1512SP-1 PN CPU 1512SP F-1 PN
PtP communication		
Port_Config	uses RDDEC, WRREC	
Send_Config	uses RDDEC, WRREC	
Receive_Config	uses RDDEC, WRREC	
Send_P2P	uses RDDEC, WRREC	
Receive_P2P	uses RDDEC, WRREC	
Receive_Reset	uses RDDEC, WRREC	
Signal_Get	uses RDDEC, WRREC	
Signal_Set	uses RDDEC, WRREC	
Get_Features	uses RDDEC, WRREC	
Set_Features	uses RDDEC, WRREC	
USS communication		
USS_Port_Scan	uses RDDEC, WRREC	
MODBUS (RTU)		
Modbus_Comm_Load	uses RDDEC, WRREC	
ET 200S serial interface		
S_USSI	uses CREATE_DB	
SIMATIC NET		
FTP_CMD	uses TSEND, TRCV, TCON, TDISCON	

Technology: Maximum number of asynchronous instructions

The following table shows the maximum number of simultaneously running jobs for asynchronous instructions (Technology).

Technology	CPU 1510SP-1 PN CPU 1510SP F-1 PN CPU 1512SP-1 PN CPU 1512SP F-1 PN
Motion Control	
MC_Power MC_Reset MC_Home MC_Halt MC_MoveAbsolute MC_MoveRelative MC_MoveVelocity MC_MoveJog MC_GearIn MC_MoveSuperimposed	300

Additional information

You can find additional information on block parameter assignment in the STEP 7 online help.

Protection

8.1 Overview of the protective functions of the CPU

Introduction

This chapter describes the following functions for protecting the ET 200SP against unauthorized access:

- Access protection
- Know-how protection
- Copy protection

Further measures for protecting the CPU

The following measures additionally increase the protection against unauthorized access to functions and data of the CPU from external sources and via the network:

- Deactivation of the Web server
- Deactivation of time synchronization via an NTP server
- Deactivation of PUT/GET communication

If you use the Web server, protect your ET 200SP distributed I/O system against unauthorized access by setting password-protected access rights for specific users in the user management.

8.2 Configuring access protection for the CPU

Introduction

The CPU offers four access levels, in order to limit access to specific functions.

By setting up the access levels and the passwords for a CPU, you limit the functions and memory areas that are accessible without entering a password. You specify the individual access levels as well as the entry of their associated passwords in the object properties of the CPU.

Access levels of the CPU

Table 8- 1 Access levels of the CPU

Access levels	Access restrictions
Full access (no protection)	Any user can read and change the hardware configuration and the blocks.
Read access	<p>With this access level, read-only access to the hardware configuration and the blocks is possible without entering a password, which means you can download the hardware configuration and blocks to the programming device. In addition, HMI access and access to diagnostics data is possible.</p> <p>Without entering the password, you cannot load any blocks or hardware configuration into the CPU. Additionally, the following are not possible without the password:</p> <ul style="list-style-type: none"> • Writing test functions • Firmware update (online)
HMI access	<p>With this access level only HMI access and access to diagnostics data is possible without entering the password.</p> <p>Without entering the password, you can neither load blocks nor the hardware configuration into the CPU, nor load blocks and hardware configuration from the CPU into the programming device. Additionally, the following are not possible without the password:</p> <ul style="list-style-type: none"> • Writing test functions • Changing the mode (RUN/STOP) • Firmware update (online)
No access (complete protection)	<p>No read or write access to the hardware configuration and the blocks is possible if the CPU is completely protected. HMI access is also not possible. The server function for PUT/GET communication is disabled in this access level (cannot be changed).</p> <p>Authentication with the password will again provide you full access to the CPU.</p>

Each access level allows unrestricted access to certain functions without entering a password, for example, identification using the "Accessible devices" function.

The CPU's default setting is "No restriction" and "No password protection". In order to protect access to a CPU, you need to edit the properties of the CPU and set up a password. In the default access level "Full access (no protection)" every user can read and change the hardware configuration and the blocks. A password is not set and is also not required for online access.

The access level of the CPU does not restrict communication between the CPUs (via the communication functions in the blocks) unless PUT/GET communication is deactivated.

Entry of the right password allows access to all the functions that are allowed in the corresponding level.

Note

Configuring an access level does not replace know-how protection

Configuring access levels offers a high degree of protection against unauthorized changes to the CPU by restricting the rights to download the hardware and software configuration to the CPU. However, blocks on the SIMATIC memory card are not write- or read-protected. Use know-how protection to protect the code of blocks on the SIMATIC memory card.

Behavior of functions with different access levels

The STEP 7 online help includes a table which lists the online functions that are available in the different access levels.

Selecting the access levels

To configure the access levels of a CPU, follow these steps:

1. Open the properties of the CPU in the Inspector window.
2. Open the "Protection" entry in the area navigation.

A table with the possible access levels is available in the Inspector window.

Access level	Access			Access permission
	HMI	Read	Write	Password
<input type="radio"/> Full access (no protection)	✓	✓	✓	
<input checked="" type="radio"/> Read access	✓	✓		Enter password: <input type="text"/>
<input type="radio"/> HMI access	✓			Confirm password: <input type="text"/>
<input type="radio"/> No access (complete protection)				

Read access:
TIA Portal users will have read access to all functions.
HMI applications can access all functions.

Mandatory password:
For additional write access, TIA Portal users need to enter the "full access" password.

Figure 8-1 Possible access levels

3. Activate the desired protection level in the first column of the table. The green check marks in the columns to the right of the access level show you which operations are still available without entering the password.
4. In the "Enter password" column, specify a password for the access level "Full access" in the first row. In the "Confirm password" column, enter the selected password again to guard against incorrect entries.
Ensure that the password is sufficiently secure, i.e. does not follow a pattern that can be recognized by a machine.
5. Assign additional passwords as needed to other access levels if the selected access level allows you to do so.
6. Download the hardware configuration to the CPU, so that the access level will take effect.

The CPU logs the entry of the correct or incorrect password and any changes in the configuration of the access levels by a corresponding entry in the diagnostics buffer.

Behavior of a password-protected CPU during operation

The CPU protection takes effect after you have downloaded the settings to the CPU.

Before an online function is executed, the CPU checks the necessary permission and, if necessary, prompts the user to enter a password. You can only execute password-protected functions from one programming device/PC at any time. Another programming device/PC cannot log on.

Access authorization to the protected data is in effect for the duration of the online connection or until you rescind the access authorization manually with "Online > Delete access rights".

Access levels for F-CPU

For the fail-safe CPUs, there is an additional access level in addition to the four described access levels. For additional information on this access level, refer to the description of the fail-safe system SIMATIC Safety Programming and Operating Manual SIMATIC Safety - Configuring and Programming

(<http://support.automation.siemens.com/WW/view/en/54110126>).

8.3 Using the user program to set additional access protection

Access protection via user program

You can also restrict access to a password-protected CPU in STEP 7 using the block SFC 110. You can find a description of this block in the online help under the keyword "ENDIS_PW: Limit and enable password legitimation".

8.4 Know-how protection

Application

You can use know-how protection to protect one or more OB, FB or FC blocks as well as global data blocks in your program from unauthorized access. Enter a password to restrict access to a block. The password offers high-level protection against unauthorized reading or manipulation of the block.

Readable data

If a block is know-how protected, only the following data is readable without the correct password:

- Block title, comments and block properties
- Block parameters (INPUT, OUTPUT, IN, OUT, RETURN)
- Call structure of the program
- Global tags without information on the point of use

Further actions

Further actions that can be carried out with a know-how protected block:

- Copying and deleting
- Calling in a program
- Online/offline comparison
- Load

Global data blocks and array data blocks

You can provide global data blocks (global DBs) with know-how protection. Users who do not possess the valid password can read the global data block but not change it.

You cannot provide array data blocks (array DBs) with know-how protection.

Setting up block know-how protection

To set up block know-how protection, follow these steps:

1. Open the properties of the block in question.
2. Select the "Protection" option under "General".

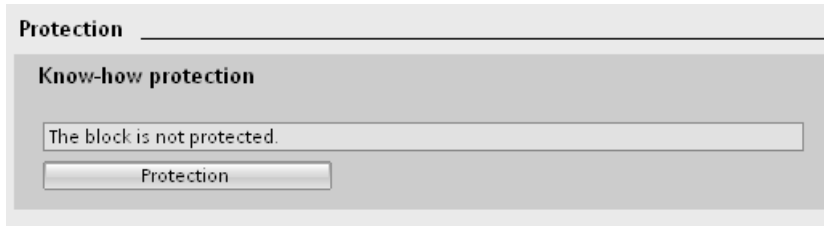


Figure 8-2 Setting up block know-how protection (1)

3. Click the "Protection" button to display the "Know-how protection" dialog.



Figure 8-3 Setting up block know-how protection (2)

4. Click the "Define" button to open the "Define Password" dialog.



Figure 8-4 Setting up block know-how protection (3)

5. Enter the new password in the "New password" box. Enter the same password in the "Confirm password" box.
6. Click "OK" to confirm your entry.
7. Close the "Know-how protection" dialog by clicking "OK".

Result: The selected blocks are now know-how protected. Know-how protected blocks are marked with a lock in the project tree. The password entered applies to all blocks selected.

Opening know-how protected blocks

To open a know-how protected block, follow these steps:

1. Double-click the block to open the "Access protection" dialog.
2. Enter the password for the know-how protected block.
3. Click "OK" to confirm your entry.

Result: The know-how-protected block is open.

Once you have opened the block, you can edit the program code and the block interface of the block for as long as the block or STEP 7 is open. You must enter the password again the next time you open the block. If you close the "Access protection" dialog with "Cancel", you will be able to open the block but you cannot display the block code or edit the block.

If you copy the block or add it to a library, for example, this does not cancel the know-how protection of the block. The copies will also be know-how-protected.

Removing block know-how protection

To remove block know-how protection, follow these steps:

1. Select the block from which you want to remove know-how protection. The protected block must not be open in the program editor.
2. In the "Edit" menu, select the "Know-how protection" command to open the "Know-how protection" dialog.
3. Clear the "Hide code (Know-how protection)" check box.

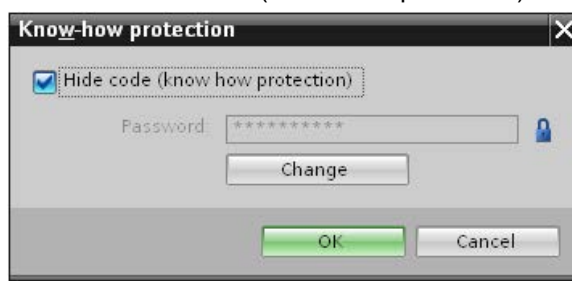


Figure 8-5 Removing block know-how protection (1)

4. Enter the password.



Figure 8-6 Removing block know-how protection (2)

5. Click "OK" to confirm your entry.

Result: Know-how protection is removed from the selected block.

8.5 Copy protection

Application

Copy protection allows you to link the program or the blocks to a specific SIMATIC memory card or CPU. By linking this program or block to the serial number of a SIMATIC memory card or a CPU, you allow its use only in combination with this specific SIMATIC memory card or CPU. With this function you can send a program or block electronically (e.g. by e-mail) or by shipping a memory module.

Copy and know-how protection

If you set up copy protection for a block, you should also assign know-how protection to the block. Without know-how protection, anyone can reset the copy protection. However, you must first set up the copy protection because the copy protection settings are read-only on a know-how protected block.

Setting up copy protection

To set up copy protection, follow these steps:

1. Open the properties of the block in question.
2. Select the "Protection" option under "General".



Figure 8-7 Setting up copy protection (1)

3. In the "Copy protection" area, select either the "Bind to serial number of the CPU" entry or the "Bind to serial number of the memory card" entry from the drop-down list.

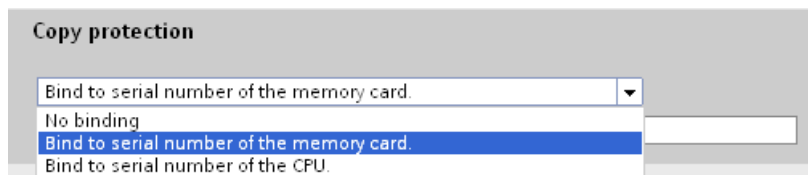


Figure 8-8 Setting up copy protection (2)

4. Activate the option "Serial number is inserted when downloading to a device or a memory card" if the serial number is to be inserted automatically during the download process (dynamic binding). Assign a password using the "Define password" button to link the use of a block additionally to the input of a password.
Activate the option "Enter serial number" if you want to manually bind the serial number of the CPU or the SIMATIC memory card to a block (static binding).
5. You can now set up the know-how protection for the block in the "Know-how protection" area.

Note

If you download a copy-protected block to a device that does not match the specified serial number, the entire download operation will be rejected. This means that blocks without copy protection will also not be downloaded.

Removing copy protection

To remove copy protection, follow these steps:

1. Remove any existing know-how protection.
2. Open the properties of the block in question.
3. Select the "Protection" option under "General".
4. In the "Copy protection" area, select the "No binding" entry from the drop-down list.

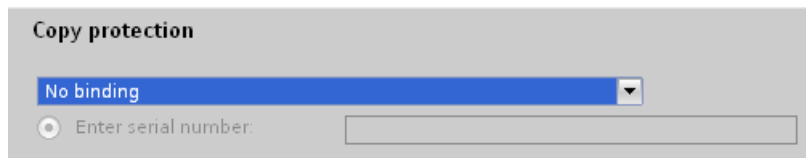


Figure 8-9 Removing copy protection

Configuration control (option handling)

Introduction

Configuration control (option handling) is used to operate various standard machine configuration levels in one project without changing the configuration or the user program.

Operating principle of configuration control

You can use configuration control to operate different standard machine configurations with a single configuration of the ET 200SP distributed I/O system.

- A station master is configured in a project (maximum configuration). The station master comprises all modules needed for all possible plant parts of a modular standard machine.
- The project's user program provides for several station options for various standard machine configuration levels as well as selection of a station option. A station option uses, for example, only some of the configured modules of the station master and these modules are inserted in the slots in a different order.
- The standard machine manufacturer selects a station option for a configuration of the standard machine. To do this, the project need not be modified, and it is not necessary to load a modified configuration.

You use a control data record you have programmed to notify the CPU/interface module as to which modules are missing or located on different slots in a station option as compared to the station master. The configuration control does not have an impact on the parameter assignment of the modules.

Configuration control allows you to flexibly vary the centralized/distributed configuration. This is only possible if the station option can be derived from the station master.

The following figure shows three configurations of a standard machine with the corresponding station options of the ET 200SP distributed I/O system.

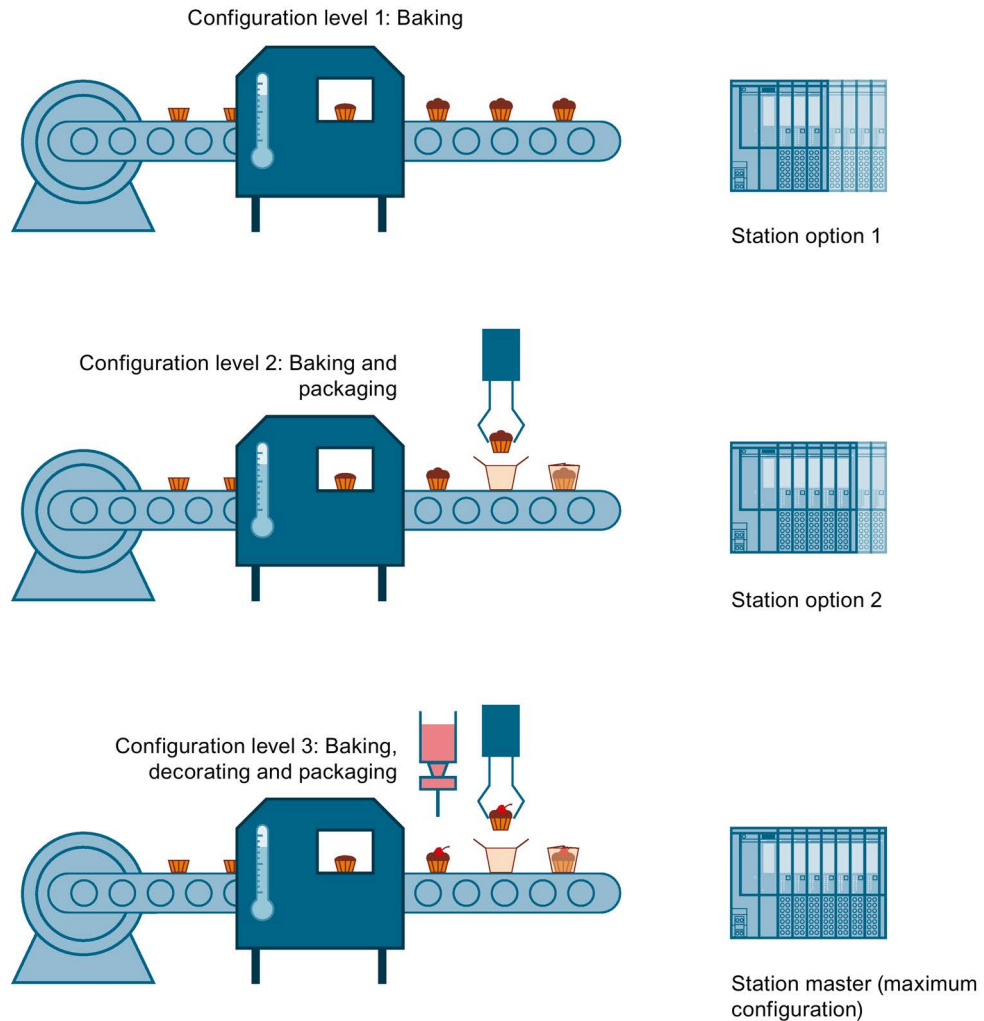


Figure 9-1 Various configuration levels of a standard machine with the corresponding station options of the ET 200SP distributed I/O system.

Advantages

- Simple project management and commissioning by using a single STEP 7 project for all station options.
- Simple handling for maintenance, versioning and upgrade:
- Hardware savings: Only those I/O modules are installed that are required for the machine's current station option.
- Savings potential in the creation, commissioning and the documentation for standard machines.
- Simple station expansion by using pre-wired empty slots. To expand, you simply exchange the BU cover for the new model.

Procedure

To set up the configuration control, follow these steps:

Step	Procedure	See...
1	Enable configuration control in STEP 7	Section Configuring (Page 145)
2	Create control data record	Section Creating the control data record (Page 147)
3	Transfer control data record	Section Transferring the control data record in the startup program of the CPU (Page 158)

Block library "OH_S71x00_Library"

The block library OH_S71x00_Library (<https://support.industry.siemens.com/cs/#document/29430270?lc=en-WW>) is available for download from the Internet. The block library contains data types with the structure of the control data records for the ET 200SP distributed I/O system. You can implement your flexible automation solution inexpensively with the help of these data types.

9.1 Configuring

Requirements

Configuration control is supported by the ET 200SP distributed I/O system with both an ET 200SP CPU and with interface modules via PROFINET IO and PROFIBUS DP.

Centrally for ET 200SP CPU:

- STEP 7 Professional V13 Update 3 or higher
- CPU 1510SP-1 PN/CPU 1512SP-1 PN
- Firmware version V1.6 or higher
- All modules of the CPU must be able to start up even with different configurations.
 - The startup parameter "Comparison preset to actual configuration" of the CPU is set to "Startup CPU even if mismatch" (default setting) and the module parameter "Comparison preset to actual module" of the module is set to "From CPU" (default setting).
 - or
 - The module parameter "Comparison preset to actual module" for the module is set to "Startup CPU even if mismatch".

Distributed via PROFINET IO:

- Engineering Tool (e.g. STEP 7)
- IM 155-6 PN BA/ST/HF
- You have assigned the interface module to an IO controller.

Distributed via PROFIBUS DP:

- Engineering Tool (e.g. STEP 7)
- IM 155-6 DP HF
- You have assigned the interface module to a DP master.
- The startup parameter is set to "Operate if preset configuration does not match actual configuration"

Required steps

Enable the "Allow to reconfigure the device via the user program" parameter when configuring the CPU/interface module in STEP 7 (TIA Portal).

- The "Allow to reconfigure the device via the user program" parameter is located in the "Configuration control" area for an ET 200SP CPU.
- The "Allow to reconfigure the device via the user program" parameter is located in the "Module parameter" area under "General" for an IM 155-5 PN interface module.

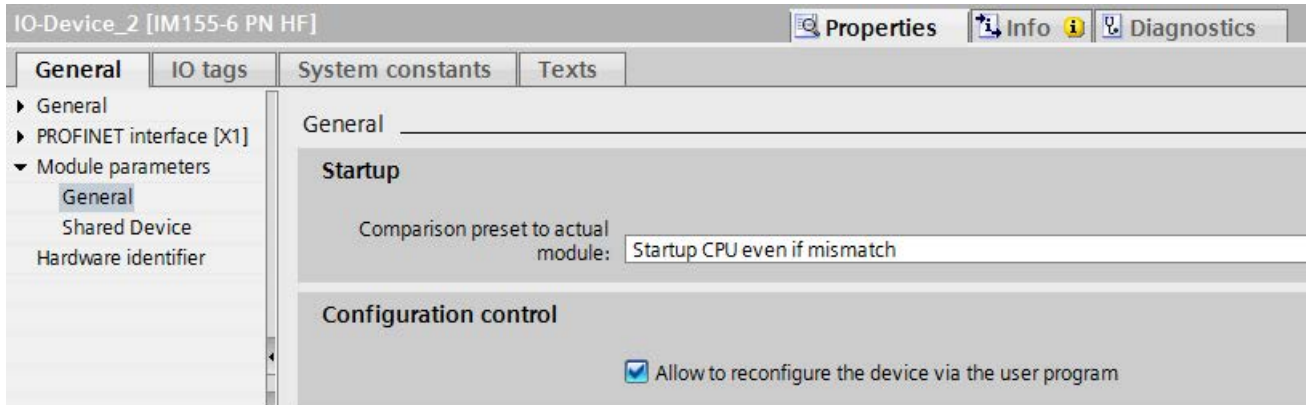


Figure 9-2 Enabling configuration control using an IM 155-6 PN HF as an example

9.2 Creating the control data record

9.2.1 Introduction

Required steps

To create a control data record for the configuration control, follow these steps:

1. Create a PLC data type which contains the structure of the control data record.
The following figure shows a PLC data type "CTR_REC", which contains the structure of the control data record for an ET 200SP interface module.

CTR_REC							
	Name	Data type	Default value	A...	V...	S...	Comment
1	Block_Lenght	USInt	134	<input checked="" type="checkbox"/>	<input checked="" type="checkbox"/>	<input type="checkbox"/>	4 + (2 x number of Slots)
2	Block_ID	USInt	196	<input checked="" type="checkbox"/>	<input checked="" type="checkbox"/>	<input type="checkbox"/>	
3	Version	USInt	2	<input checked="" type="checkbox"/>	<input checked="" type="checkbox"/>	<input type="checkbox"/>	ET 200SP
4	Subversion	USInt	0	<input checked="" type="checkbox"/>	<input checked="" type="checkbox"/>	<input type="checkbox"/>	
5	Slot 1	USInt	1	<input checked="" type="checkbox"/>	<input checked="" type="checkbox"/>	<input type="checkbox"/>	assigned "real" slot
6	Add 1	USInt	0	<input checked="" type="checkbox"/>	<input checked="" type="checkbox"/>	<input type="checkbox"/>	additional function
7	Slot 2	USInt	2	<input checked="" type="checkbox"/>	<input checked="" type="checkbox"/>	<input type="checkbox"/>	assigned "real" slot
8	Add 2	USInt	0	<input checked="" type="checkbox"/>	<input checked="" type="checkbox"/>	<input type="checkbox"/>	additional function
9	Slot 3	USInt	3	<input checked="" type="checkbox"/>	<input checked="" type="checkbox"/>	<input type="checkbox"/>	assigned "real" slot
10	Add 3	USInt	0	<input checked="" type="checkbox"/>	<input checked="" type="checkbox"/>	<input type="checkbox"/>	additional function
11	Slot 4	USInt	4	<input checked="" type="checkbox"/>	<input checked="" type="checkbox"/>	<input type="checkbox"/>	assigned "real" slot
12	Add 4	USInt	0	<input checked="" type="checkbox"/>	<input checked="" type="checkbox"/>	<input type="checkbox"/>	additional function

Figure 9-3 Creating control data record 196 using an IM 155-6 PN HF as an example

2. Create a global data block.

3. In the data block, create an array that is based on the created PLC data type.
4. In the control data records, enter the slot assignments in the "Start value" column.

The figure below shows the global data block "ConfDB". The data block "ConfDB" contains an array [0..5] of the PLC_DataType "CTR_REC".

ConfDB									
	Name	Data type	Start value	R..	A...	V...	S..	Comment	
1	Static			<input type="checkbox"/>	<input type="checkbox"/>	<input type="checkbox"/>	<input type="checkbox"/>		
2	Option	Int	0	<input checked="" type="checkbox"/>	<input checked="" type="checkbox"/>	<input checked="" type="checkbox"/>	<input type="checkbox"/>	Selection of record	
3	ConfigControl	Array[0..5] of "CTR_REC"		<input type="checkbox"/>	<input checked="" type="checkbox"/>	<input checked="" type="checkbox"/>	<input type="checkbox"/>		
4	ConfigControl[0]	"CTR_REC"		<input type="checkbox"/>	<input checked="" type="checkbox"/>	<input checked="" type="checkbox"/>	<input type="checkbox"/>		
5	ConfigControl[1]	"CTR_REC"		<input type="checkbox"/>	<input checked="" type="checkbox"/>	<input checked="" type="checkbox"/>	<input type="checkbox"/>		
6	Block_Length	USInt	0	<input type="checkbox"/>	<input checked="" type="checkbox"/>	<input checked="" type="checkbox"/>	<input type="checkbox"/>	4 + (2 x number of slots)	
7	Block_ID	USInt	196	<input type="checkbox"/>	<input checked="" type="checkbox"/>	<input checked="" type="checkbox"/>	<input type="checkbox"/>		
8	Version	USInt	2	<input type="checkbox"/>	<input checked="" type="checkbox"/>	<input checked="" type="checkbox"/>	<input type="checkbox"/>	ET 2005P	
9	Subversion	USInt	0	<input type="checkbox"/>	<input checked="" type="checkbox"/>	<input checked="" type="checkbox"/>	<input type="checkbox"/>		
10	Slot 1	USInt	1	<input type="checkbox"/>	<input checked="" type="checkbox"/>	<input checked="" type="checkbox"/>	<input type="checkbox"/>	assigned "real" slot	
11	Add 1	USInt	0	<input type="checkbox"/>	<input checked="" type="checkbox"/>	<input checked="" type="checkbox"/>	<input type="checkbox"/>	additional function	
12	Slot 2	USInt	2	<input type="checkbox"/>	<input checked="" type="checkbox"/>	<input checked="" type="checkbox"/>	<input type="checkbox"/>	assigned "real" slot	
13	Add 2	USInt	0	<input type="checkbox"/>	<input checked="" type="checkbox"/>	<input checked="" type="checkbox"/>	<input type="checkbox"/>	additional function	
14	Slot 3	USInt	3	<input type="checkbox"/>	<input checked="" type="checkbox"/>	<input checked="" type="checkbox"/>	<input type="checkbox"/>	assigned "real" slot	
15	Add 3	USInt	0	<input type="checkbox"/>	<input checked="" type="checkbox"/>	<input checked="" type="checkbox"/>	<input type="checkbox"/>	additional function	
16	Slot 4	USInt	4	<input type="checkbox"/>	<input checked="" type="checkbox"/>	<input checked="" type="checkbox"/>	<input type="checkbox"/>	assigned "real" slot	
17	Add 4	USInt	0	<input type="checkbox"/>	<input checked="" type="checkbox"/>	<input checked="" type="checkbox"/>	<input type="checkbox"/>	additional function	

Figure 9-4 Data block for configuration control

Rules

Observe the following rules:

- Slot entries in the control data record outside the station master are ignored by the CPU/interface module.
- The control data record must contain the entries up to the last slot of the station option.
- Multiple configured slots may not be assigned to the same actual slot. In other words, each station option slot may be present only once in the control data record.

9.2.2 Control data record for an ET 200SP CPU

Slot assignment

The following table shows the possible slots for the various modules for an ET 200SP CPU:

Table 9- 1 Slot assignment

Modules	Possible slots	Comment
CPU	1	Slot 1 is always the CPU
I/O modules	2 - 65	Downstream of CPU
Server module	2 - 66	The server module completes the configuration of the ET 200SP station after the CPU/the last I/O module.

Control data record

For the configuration control of an ET 200SP CPU, you define a control data record 196 V2.0, which includes a slot assignment. The maximum slot corresponds to the slot of the server module.

The table below shows the structure of a control data record with explanations of the individual elements.

Table 9- 2 Configuration control: Structure of control data record 196

Byte	Element	Code	Explanation
0	Block length	4 + (number of slots × 2)	Header
1	Block ID	196	
2	Version	2	
3	Version	0	
4	Slot 1 of the station master	Slot assignment 1 in the station option (always 1, because the CPU is always in slot 1)	<p>Control element</p> <p>Contains the information on which module is inserted in which slot.</p> <p>The value that you need to enter in the corresponding byte depends on the following rule:</p> <ul style="list-style-type: none"> • If the module exists in the station option, enter the slot number of the module. • If the module exists as empty slot (with BU cover), enter the slot number of the module + 128. (Example: module as empty slot on slot 3: Enter 131 in the control element) • If the module does not exist in the station option, enter 0. <p>Additional function</p> <p>Contains information on whether a new potential group will be opened in the station option - by replacing a dark-colored BaseUnit with a light-colored BaseUnit.</p> <ul style="list-style-type: none"> • If you replace a dark-colored BaseUnit with a light-colored BaseUnit, enter 1 as additional function. • If you accept the BaseUnit from the station master, enter 0 as additional function.
5	Additional function for slot 1		
6	Slot 2 of the station master	Slot assignment in the station option	
7	Additional function for slot 2		
8	Slot 3 of the station master	Slot assignment in the station option	
9	Additional function for slot 3		
:	:	:	
4 + ((max. slot - 1) × 2)	Server module slot	Server module slot assignment in the station option*	
4 + ((max. slot - 1) × 2) + 1	Additional function for server module slot		

* The server module must be present in the station option and must not be marked as empty slot (BU cover).

9.2.3 Control data record for an interface module

Slot assignment

The following table shows the possible slots for the various modules for an ET 200SP interface module:

Table 9- 3 Slot assignment

Modules	Possible slots	Comment	
Interface module	0	The interface module (slot 0) is not an element of the configuration control, but instead controls this.	
Station extension BA-Send	1	For mixed configuration with ET 200AL modules, BA-Send is always on slot 1.	
ET 200SP I/O module	1 - 12	for IM 155-6 PN BA	Downstream from the interface module
	1 - 32	for IM 155-6 PN ST, IM 155-6 DP HF	
	1 - 64	for IM 155-5 PN HF	
Server module	1 - 13	for IM 155-6 PN BA	The server module completes the configuration of the ET 200SP station after the last I/O module.
	1 - 33	for IM 155-6 PN ST, IM 155-6 DP HF	
	1 - 65	for IM 155-5 PN HF	
ET 200AL I/O module	34 - 49	for IM 155-6 DP HF	For mixed configuration with ET 200AL modules
	66 - 81	for IM 155-6 PN ST, IM 155-6 PN HF	

Simplified control data record (V1)

For the configuration control of interface modules of the ET 200SP distributed I/O system, you define a control data record 196 V1.0, which includes a slot assignment. The maximum slot of the configuration corresponds to the slot of the server module or ET 200AL I/O module (in a mixed ET 200SP / ET 200AL configuration).

The table below shows the structure of a control data record with explanations of the individual elements.

Table 9- 4 Structure of the simplified control data record V1.0

Byte	Element	Code	Explanation
0	Block length	4 + maximum slot	Header
1	Block ID	196	
2	Version	1	
3	Version	0	
4	Slot 1 of the station master	Slot assignment in the station option	Control element ET 200SP Contains the information on which ET 200SP module is inserted in which slot. The value that you need to enter in the corresponding byte depends on the following rule:
5	Slot 2 of the station master	Slot assignment in the station option	
:	:	:	
4 + (slot server module - 1)	Server module slot	Assignment of server module slot in the station option*	<ul style="list-style-type: none"> • If the module exists in the station option, enter the slot number of the module. • If the module exists as empty slot (with BU cover), enter the slot number of the module + 128. (Example: module as empty slot on slot 3: Enter 131 in the control element) • If the module does not exist in the station option, enter 0.
:	:	:	:
4 + (first slot ET 200AL - 1)	First slot ET 200AL	Slot assignment in the station option	Control element ET 200AL Contains information on which ET 200AL module is inserted in which slot. The value that you need to enter in the corresponding byte depends on the following rule:
:	:	:	
4 + (last slot ET 200AL - 1)	Last slot ET 200AL	Slot assignment in the station option	<ul style="list-style-type: none"> • If the module exists in the station option, enter the slot number of the module. • If the module does not exist in the station option, enter 0.

* The server module must be present in the station option and must not be marked as empty slot (BU cover).

Control data record (V2)

If you change the potential groups in the station option compared to the station master, define a control data record 196 V2.0 for the ET 200SP interface module which contains a slot assignment. The maximum slot of the configuration corresponds to the slot of the server module or ET 200AL I/O module (in a mixed ET 200SP / ET 200AL configuration).

The table below shows the structure of a control data record with explanations of the individual elements.

Table 9- 5 Structure of control data record 196 V2.0

Byte	Element	Code	Explanation
0	Block length	4 + (maximum slot x 2)	Header
1	Block ID	196	
2	Version	2	
3	Version	0	
4	Slot 1 of the station master	Slot assignment in the station option	Control element ET 200SP Contains the information on which ET 200SP module is inserted in which slot. The value that you need to enter in the corresponding byte depends on the following rule: <ul style="list-style-type: none"> • If the module exists in the station option, enter the slot number of the module. • If the module exists as empty slot (with BU cover), enter the slot number of the module + 128. (Example: module as empty slot on slot 3: Enter 131 in the control element) • If the module does not exist in the station option, enter 0. Additional function Contains information on whether a new potential group will be opened in the station option - by replacing a dark-colored BaseUnit with a light-colored BaseUnit. <ul style="list-style-type: none"> • If you replace a dark-colored BaseUnit with a light-colored BaseUnit, enter 1 as additional function. • If you accept the BaseUnit from the station master, enter 0 as additional function.
5	Additional function for slot 1		
6	Slot 2 of the station master	Slot assignment in the station option	
7	Additional function for slot 2		
8	Slot 3 of the station master	Slot assignment in the station option	
9	Additional function for slot 3		
:	:	:	
4 + ((server module slot - 1) × 2)	Server module slot	Server module slot assignment in the station option*	
4 + ((server module slot - 1) × 2) + 1	Additional function for server module slot		

Byte	Element	Code	Explanation
:	:	:	:
4 + ((first slot ET 200AL - 1) x 2)	First slot ET 200AL	Slot assignment in the station option	Control element ET 200AL Contains information on which ET 200AL module is inserted in which slot. The value that you need to enter in the corresponding byte depends on the following rule: <ul style="list-style-type: none"> • If the module exists in the station option, enter the slot number of the module. • If the module does not exist in the station option, enter 0.
4 + ((first slot ET 200AL - 1) x 2) + 1	Reserved		
:	:	:	
4 + ((last slot ET 200AL - 1) x 2)	Last slot ET 200AL	Slot assignment in the station option	
4 + ((last slot ET 200AL - 1) x 2) + 1	Reserved		

* The server module must be present in the station option and must not be marked as empty slot (BU cover).

Note

If a BU cover or no I/O module is plugged on a light-colored BaseUnit, you should enter 1 in the additional function for the slot.

The function "Group diagnostics: Missing supply voltage L+" requires proper assignment of the slots to a shared supply voltage L+ (potential group). All light-colored BaseUnits must be known to the interface module. By entering 1 in the additional function, you make a light-colored BaseUnit known to the interface module, even if an I/O module is not inserted.

Combination of configuration control and shared device (for PROFINET)

The configuration control function in a shared device is therefore only for the I/O modules of the IO controller to which the interface module has subscribed. I/O modules that are assigned to no controller or a different controller behave like a station without activated configuration control.

You cannot make any change to the slot assignment for modules that are assigned to another IO controller or are not assigned to an IO controller (shared device on module level). The CPU assumes a one-to-one assignment for the modules.

If additional IO controllers subscribe to a module intended for configuration control (shared device on submodule level), only one-to-one assignment is permitted for this module. It is not possible to deselect such a module using the control data record (code 0 for this slot in the control data record). This means the combination of "Configuration control" and "Shared device on submodule level" is only possible to a limited extent.

Please note that all modules affected by the configuration control including all assigned submodules are reset when you change the module assignment. Submodules that are assigned to a second IO controller are affected as well.

9.2.4 Feedback data record for interface modules

Operating principle

The feedback data record informs you about the accuracy of the module assignment and gives you the option of detecting assignment errors in the control data record. The feedback data record is mapped via a separate data record 197 V2.0. The feedback data record exists only with configured configuration control.

Slot assignment

The feedback data record refers to the configured station configuration and always includes the maximum configuration limits. The maximum configuration limits comprise 13/49/81 slots depending on the interface module in use. Partial reading of the feedback data record is possible.

The following table shows the slot assignment of the modules:

Table 9- 6 Slot assignment

Modules	Possible slots		Comment
Station extension BA-Send	1		For mixed configuration with ET 200AL modules, BA-Send is always on slot 1.
ET 200SP I/O module	1 - 12	for IM 155-6 PN BA	Downstream from the interface module
	1 - 32	for IM 155-6 PN ST, IM 155-6 DP HF	
	1 - 64	for IM 155-5 PN HF	
Server module	1 - 13	for IM 155-6 PN BA	The server module completes the configuration of the ET 200SP station after the last I/O module.
	1 - 33	for IM 155-6 PN ST, IM 155-6 DP HF	
	1 - 65	for IM 155-5 PN HF	
ET 200AL I/O module	34 - 49	for IM 155-6 DP HF	For mixed configuration with ET 200AL modules
	66 - 81	for IM 155-6 PN ST, IM 155-6 PN HF	

Feedback data record

Table 9- 7 Feedback data record

Byte	Element	Code	Explanation	
0	Block length	4 + (number of slots x 2)	Header	
1	Block ID	197		
2	Version	2		
3		0		
4	Slot 1 status	0/1	Status = 1: <ul style="list-style-type: none"> Module from station master is inserted in the station option Slot is marked as not available in the control data record 	
5	Reserved	0		
6	Slot 2 status	0/1		
7	Reserved	0		
:	:	:		
4 + ((max. slot - 1) × 2)	Max. slot status	0/1		Status = 0: <ul style="list-style-type: none"> Module pulled Incorrect module inserted in the station option*
4 + ((max. slot - 1) × 2) + 1	Reserved	0		

* Not possible if the slot is marked as not available.

Note

The data in the feedback data record is always mapped for all modules. In a shared device configuration, it is therefore irrelevant which IO controller the respective modules are assigned to.

As long as no control data record has been sent, a one-to-one module assignment is assumed for the compilation of data record 197 (station master → station option).

Error messages

In case of error, the RDREC instruction returns the following error messages via the STATUS block parameter while reading the feedback data record:

Table 9- 8 Error messages

Error code	Meaning
80B1 _H	Invalid length; the length information in data record 197 is not correct.
80B5 _H	Configuration control not configured
80B8 _H	Parameter error The following events cause a parameter error: <ul style="list-style-type: none"> • Incorrect block ID in the header (not equal to 197) • Invalid version identifier in the header • A reserved bit was set • Multiple slots in the station master are assigned to the same slot in the station option

9.2.5 Data records and functions

Supported data records and functions

The table below shows a comparison of the supported data records and functions depending on the CPU/interface module used.

Supported data records and functions	CPU...		Interface module (IM...)			
	1510SP-1 PN 1510SP F-1 PN	1512SP-1 PN 1512SP F-1 PN	155-6 PN HF	155-6 PN ST	155-6 PN BA	155-6 DP HF
Control data record (V2)	✓	✓	✓	✓	✓	✓
Simplified control data record (V1)	--	--	✓	✓	✓	--
Read back control data record *	✓	✓	✓	✓	✓	✓
Read feedback data record	--	--	✓	✓	✓	✓

* You can read back the control data record with the RDREC instruction.

9.3 Transferring control data record in the startup program of the CPU

Required steps

Transfer the created control data record 196 to the CPU/the interface module using the instruction WRREC (Write data record) instruction.

Parameters of the instruction WRREC

Below, you will find explanations of individual parameters of the WRREC instruction which you must supply with specific values in the configuration control context. You can find additional information on the WRREC instruction in the STEP 7 online help.

ID	Hardware identifier <ul style="list-style-type: none">Use the HW identifier of the CPU for the configuration control for centrally arranged modules. If you have selected the CPU in the network view or device view, the HW identifier is available in the System constants tab of the Inspector window. Use the value of the system constant "Local~Configuration".Use the HW identifier of the interface module for the configuration control for distributed I/O. If you have selected the interface module in the network view or device view, the HW identifier is available in the System constants tab of the Inspector window. Use the value of the system constant "<Name_of_the_interface_module>~Head".
INDEX	Data record number: 196 (decimal)
RECORD	Control data record to be transferred. See the section Creating the control data record (Page 147) for the structure of the control data record.

Error messages

In case of error, the instruction WRREC returns the following error messages via the STATUS block parameter:

Table 9- 9 Error messages

Error code	Meaning
80B1 _H	Invalid length; the length information in data record 196 is not correct.
80B5 _H	Configuration control parameters not assigned.
80E2 _H	Data record was transferred in the wrong OB context. The data record must be transferred in the startup program.
80B8 _H	Parameter error A parameter error is caused by: <ul style="list-style-type: none"> • Incorrect block ID in the header (not equal to 196) • Invalid version identifier in the header • A reserved bit was set • A station master slot was assigned an invalid slot in the station option • Multiple slots in the station master are assigned to the same slot in the station option • For shared device on submodule level: Violation of defined restrictions

Selection of the station option in the user program

In order for the CPU to know which station option you want to operate, you must set up a selection option between the various control data records in the user program. You can implement the selection, for example, via an Int tag which references an array element.

Note that the tag for selecting the control data record must be located in the retentive memory area. If the tag is not retentive it will be initialized during the startup of the CPU and thus be unavailable for selection of the station option.

Special aspects relating to the transfer of the control data record to the CPU

- If you have enabled configuration control, the CPU is not ready for operation without a control data record. The CPU returns from startup to STOP if a valid control data record is not transferred in the startup OB. The central I/O is not initialized in this case. The cause for the STOP mode is entered in the diagnostics buffer.

Note

If an incorrect control data record is transferred to the CPU in the startup OB, the startup of the CPU may be prevented.

In this case, perform a reset to factory settings of the CPU and then transfer a correct control data record.

- The CPU processes the WRREC instruction for transfer of the control data record asynchronously. For this reason, you must call WRREC in the startup OB repeatedly in a loop until the output parameters "BUSY" or "DONE" indicate that the data record has been transferred.
 - Tip: To program the loop, use the SCL programming language with the REPEAT ... UNTIL instruction.

```
REPEAT
  "WRREC_DB"(REQ := "start_config_control",
             ID := "Local~Configuration",
             INDEX := 196,
             LEN := "conf_LEN",
             DONE => "conf_DONE",
             BUSY => "conf_BUSY",
             RECORD := "ConfDB".ConfigControl["ConfDB".Option],
             //Selection of control data record
             ERROR => "conf_ERROR",
             STATUS => "conf_STATUS");
UNTIL NOT "conf_BUSY"
END_REPEAT;
```

- In the graphical programming languages, you implement the loop using instructions for program control.

Example in FBD: Use the LABEL (jump label) and JMP (jump at RLO=1) instructions to program a loop.

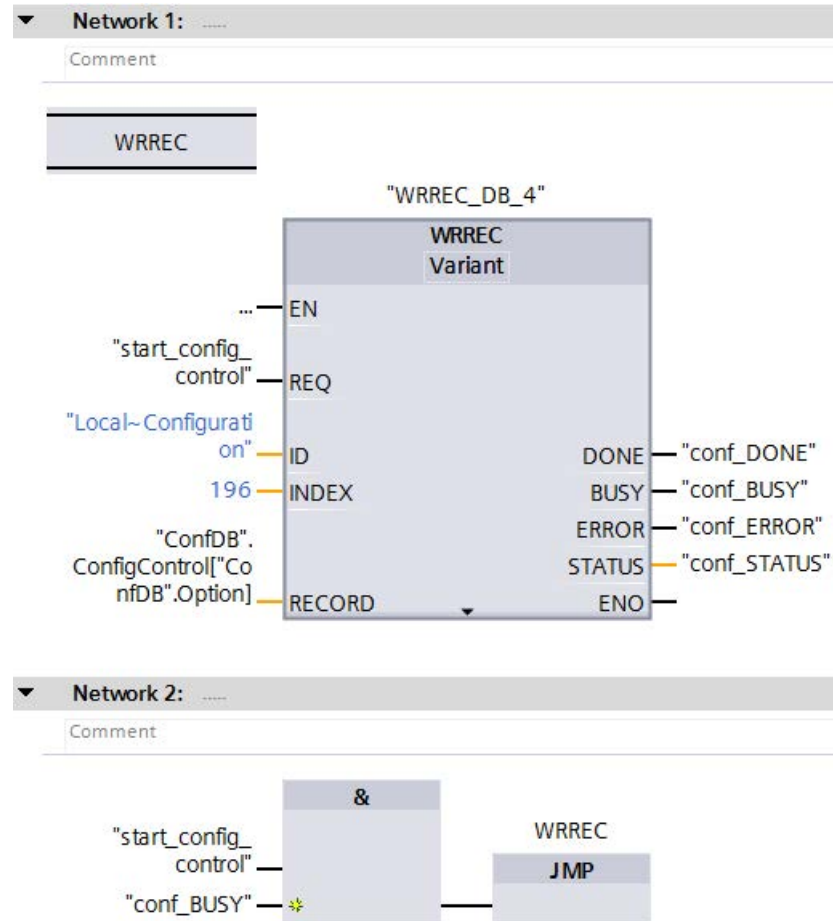


Figure 9-5 WRREC

- The control data record is stored retentively in the CPU. Note:
 - The retentivity of the control data record is independent of the retentivity settings in the STEP 7 memory area. This means that the memory area in which the control data record is configured does not have to be configured as retentive for this purpose.
 - If you write a control data record with modified configuration, the original data record 196 is deleted and the new data record 196 is saved retentively. The CPU will then restart with the modified configuration.

Special aspects relating to the transfer of the control data record to the interface module

- If you have enabled configuration control, the ET 200SP station is not ready for operation without a control data record. As long as no valid control data record has been transferred, the I/O modules are considered as failed by the CPU and exhibit substitute value behavior. The interface module continues to exchange data.
- The control data record is stored retentively in the interface module. Note:
 - If there have been no changes to the configuration, you do not need to rewrite the control data record 196 during restart.
 - If you write a control data record with modified configuration to the interface module, it will result in a station failure in the distributed I/O system. The original data record 196 is deleted and the new data record 196 is saved retentively. The station will then restart with the modified configuration.

9.4 Behavior during operation

Effect of discrepancy between station master and station option

For the online display and for the display in the diagnostics buffer (module OK or module faulty), the station master is always used and not the differing station option.

Example: A module supplies diagnostic information. This module is configured in slot 4 in the station master, but is inserted in slot 3 in the station option (missing module; see example in the next section). The online view (station master) shows a faulty module in slot 4. In the real configuration, the module in slot 3 indicates an error via an LED display.

Response when modules are missing

If modules are entered as not present in the control data record, the automation system behaves as follows:

- Modules designated as not present in the control data record do not supply diagnostics and their status is always OK. The value status is OK.
- Direct write access to the outputs that are not present or write access to the process image of the outputs that are not present: Remains without effect; no access error is signaled.
- Direct read access to the inputs that are not present or read access to the process image of the inputs that are not present: Value "0" is supplied; no access error is signaled.
- Write data record to module that is not present: Remains without effect; no error is signaled.
- Read data record from module that is not present: An error is signaled because a valid data record cannot be returned.

9.5 Examples of configuration control

A station master consisting of an interface module, three I/O modules and the server module is configured in STEP 7 in the following section.

Four station options are derived from the station master with the configuration control:

- Station option 1 with module that is not present
- Station option 2 with modified order of modules
- Station option 3 with empty slot
- Station option 4: Opening a new potential group

Station option 1 with module that is not present

The module that is located in slot 3 in the station master is not present in the station option 1. Slot 3 must be designated in the control data record accordingly with 0 (= not present). The server module is located in slot 3 in the station option.

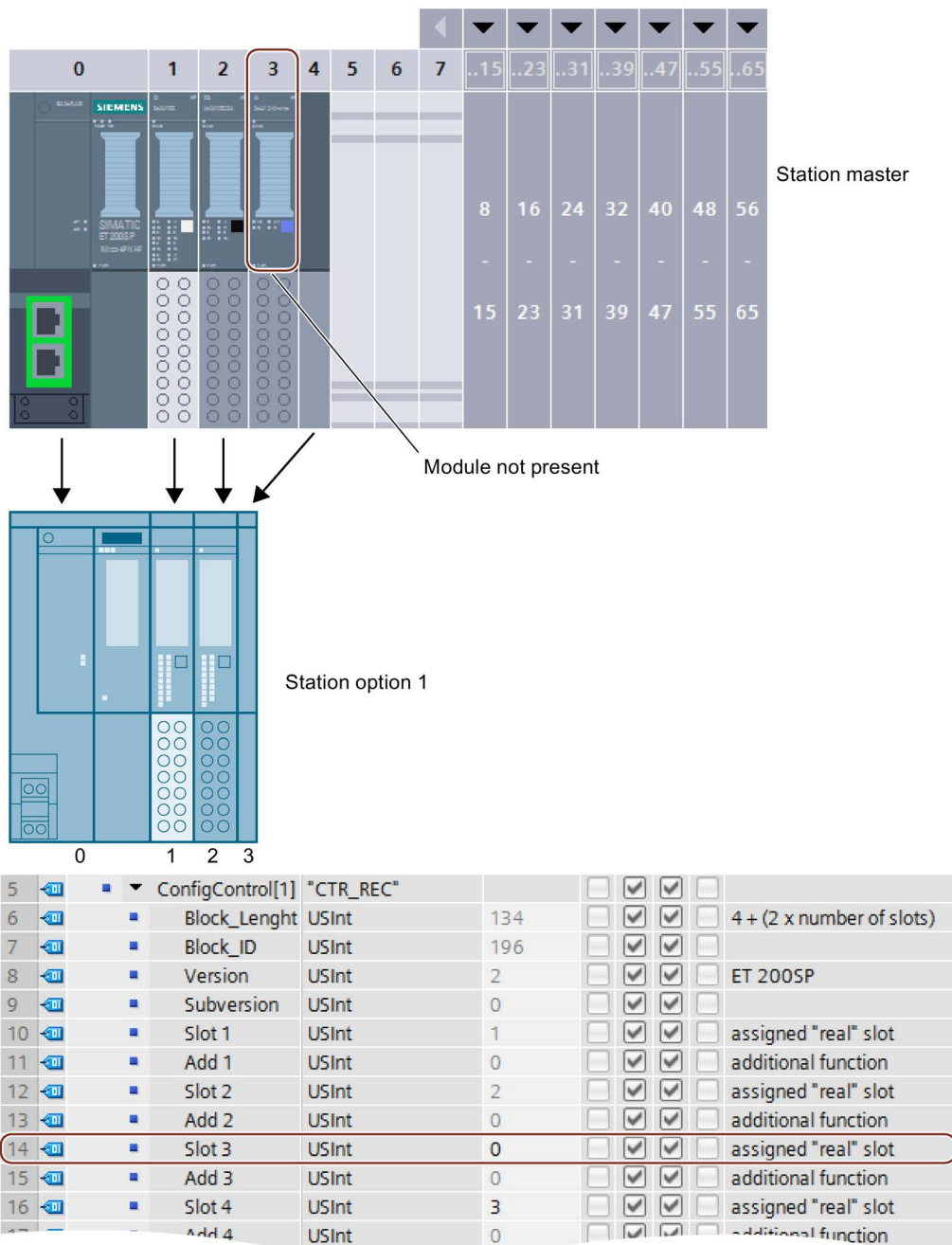


Figure 9-6 Example: Hardware configuration of station option 1 with the associated control data record in STEP 7

Station option 2 with modified order of modules

The order of the modules at slots 2 and 3 is interchanged.

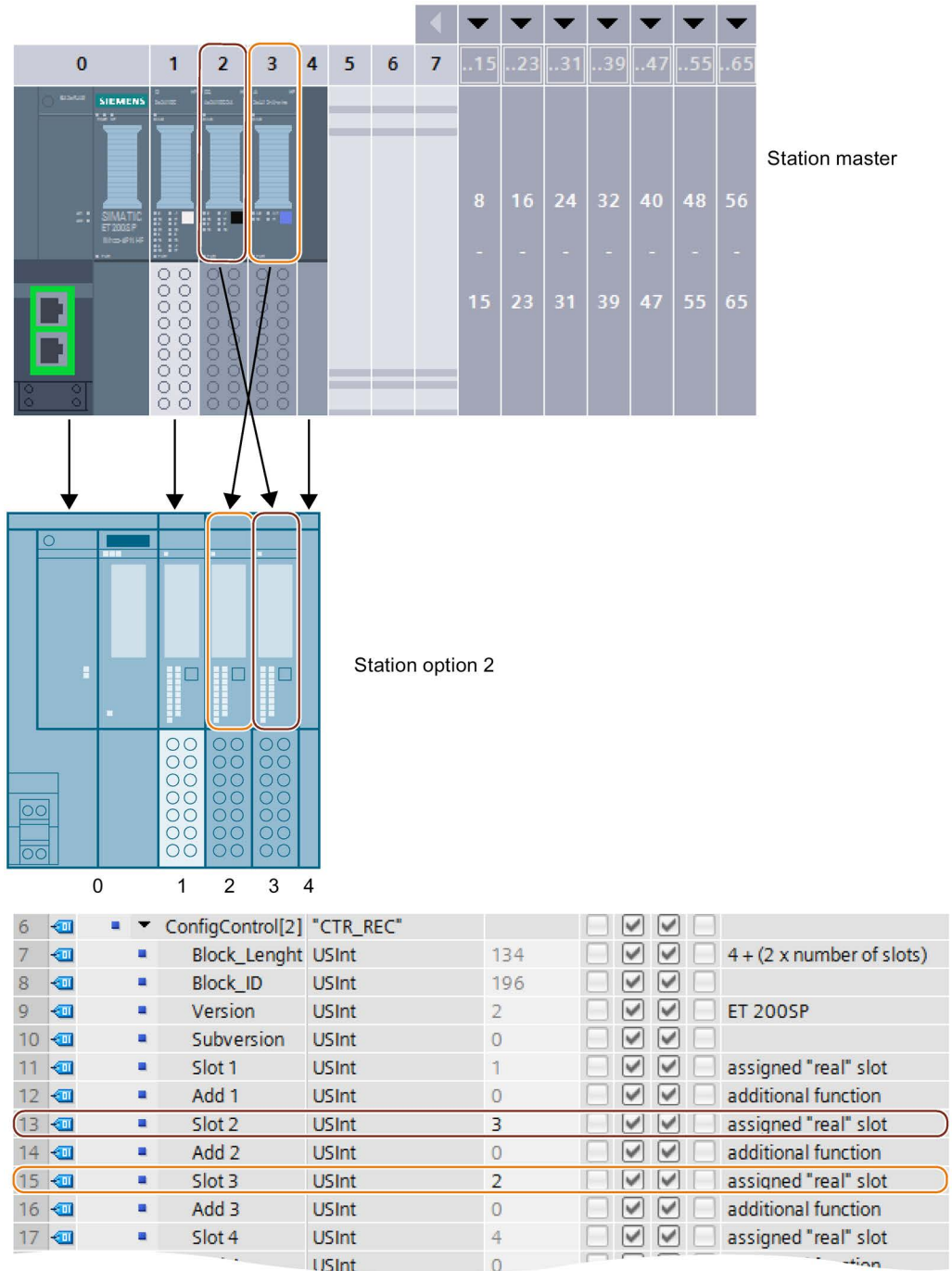


Figure 9-7 Example: Hardware configuration of station option 2 with the associated control data record in STEP 7

Station option 3 with empty slot

The module that is located in slot 3 in the station master occupies an empty slot with BU cover in the station option. Enter the value 130 in slot 3 in the control data record.

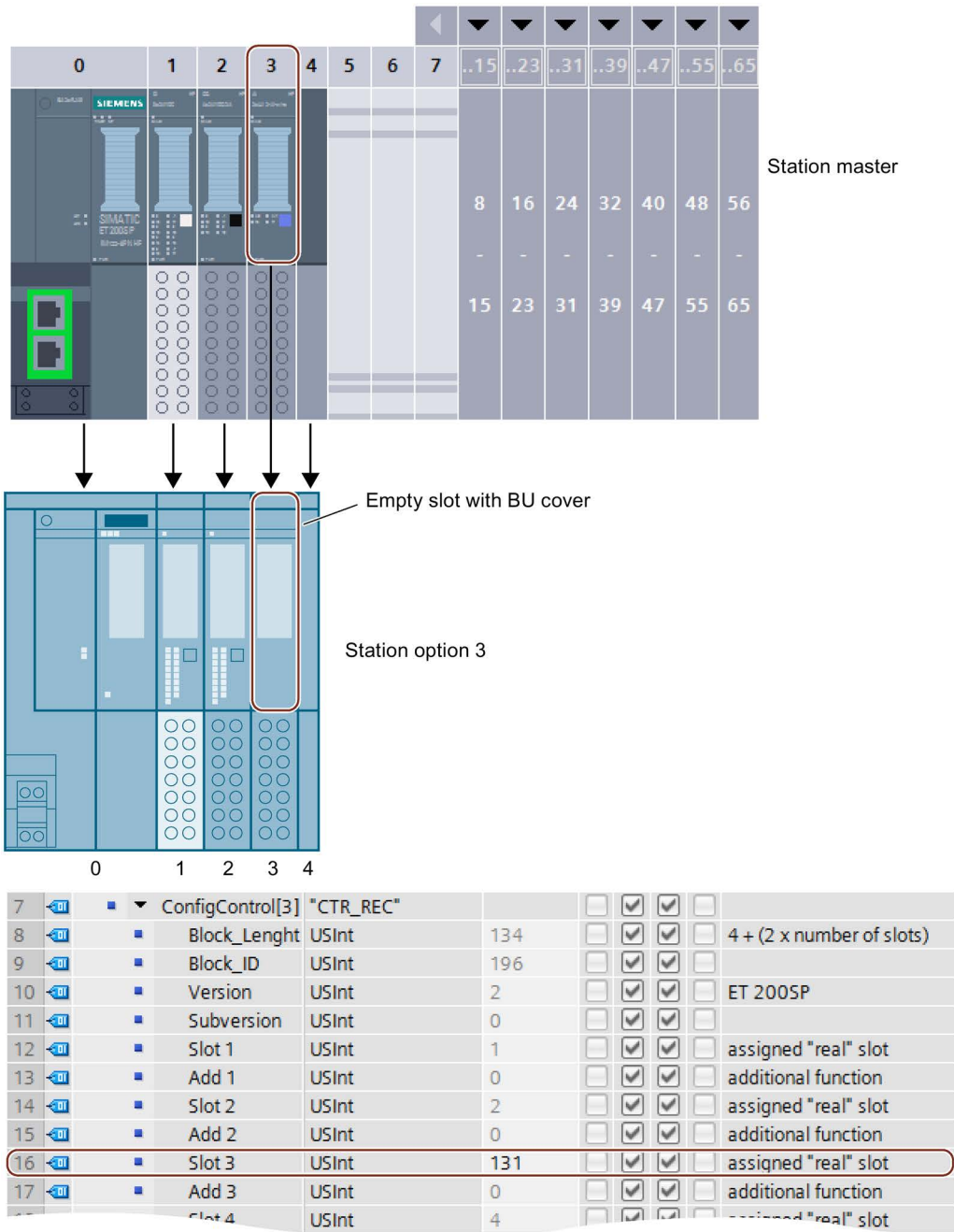


Figure 9-8 Example: Hardware configuration of station option 3 with the associated control data record in STEP 7

Station option 4: Opening a new potential group

A new potential group is opened at slot 3 of station option 4. Compared to the station master, a dark-colored BaseUnit is replaced by a light-colored BaseUnit. Enter the value 1 as additional function.

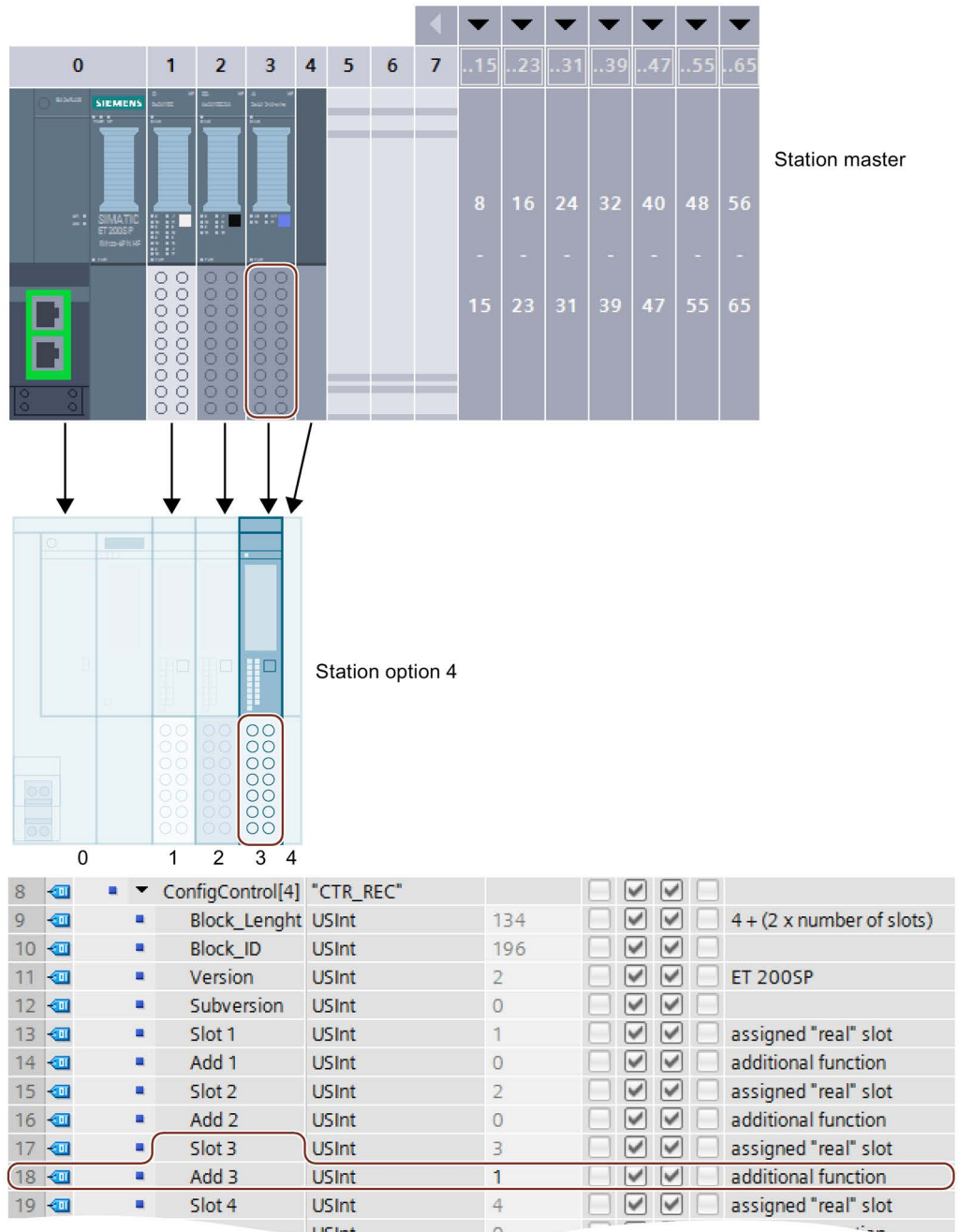


Figure 9-9 Example: Hardware configuration of station option 4 with the associated control data record in STEP 7

Commissioning

10.1 Overview

Introduction

This section includes information on the following topics:

- Commissioning the ET 200SP distributed I/O system on the PROFINET IO
- Commissioning the ET 200SP distributed I/O system on the PROFIBUS DP
- Startup of the ET 200SP distributed I/O system with empty slots
- Removing/inserting the SIMATIC memory card
- Operating modes of the CPU
- CPU memory reset
- Reassigning parameters during operation
- Identification and maintenance data

Commissioning requirements

Note

Performing tests

You must ensure the safety of your plant. You therefore need to run a complete functional test and make the necessary safety checks before the final commissioning of a plant.

Also allow for any possible foreseeable errors in the tests. This avoids endangering persons or equipment during operation.

PRONETA

SIEMENS PRONETA is a PC-based software tool that is provided free-of-charge, which simplifies the commissioning of PROFINET plants by performing the following tasks:

- Topology overview that automatically scans PROFINET and displays all connected components. This overview can be exported in the form of a device list. You have the option of "initializing" the components and performing other simple configuration tasks, as well as comparing the actual configuration with a reference plant.
- IO Check to quickly test the wiring of a plant and the module configuration of the components. By reading and writing the inputs and outputs, PRONETA makes sure that the distributed I/O devices with their sensors and actuators are wired correctly. PRONETA can create test profile templates and store test logs to document the test results.
- All tasks can be performed even before a CPU is integrated into the network. Moreover, since no other engineering tools or hardware are required, PRONETA enables a fast and convenient check of a plant configuration at an early stage.

Additional information about PRONETA can be found here (<http://support.automation.siemens.com/WW/view/en/67460624>).

SIMATIC Automation Tool

SIMATIC Automation Tool is a free, PC-based software tool which supports you during commissioning of the S7-1500 automation system/ET 200MP and ET 200SP distributed I/O system.

You carry out commissioning and service activities with this tool independent of the TIA Portal.

It offers the following functions:

- Scanning of a PROFINET/Ethernet plant network and identification of all connected devices
- Address assignment (IP, subnet, gateway) and station name (PROFINET device)
- Transfer of the date and programming device/PC time converted to UTC time to the modules
- Program download to the CPU (not F-programs)
- Switchover of the operating modes RUN/STOP
- Backup and restore of projects (not F-projects)
- Localization of the CPU by means of LED flashing
- Reading out of service data
- Reset to factory settings
- Updating the firmware of the CPU and connected modules
- Documentation/backup of the configuration in standard text .csv or encrypted and password-protected .sat file

Additional information on the SIMATIC Automation Tool is available here (<https://support.industry.siemens.com/cs/ww/de/view/98161300>).

10.2 Commissioning the ET 200SP for PROFINET IO

Requirements

- The CPU/interface module is in the "Factory settings" status or has been reset to factory settings (see section Interface module (<http://support.automation.siemens.com/WW/view/en/55683316/133300>)).
- For CPU: The SIMATIC memory card is as delivered or has been formatted.

10.2.1 ET 200SP CPU as an IO controller

Configuration example

To use the ET 200SP distributed I/O system as an IO controller, you require the CPU 151xSP-1 PN.

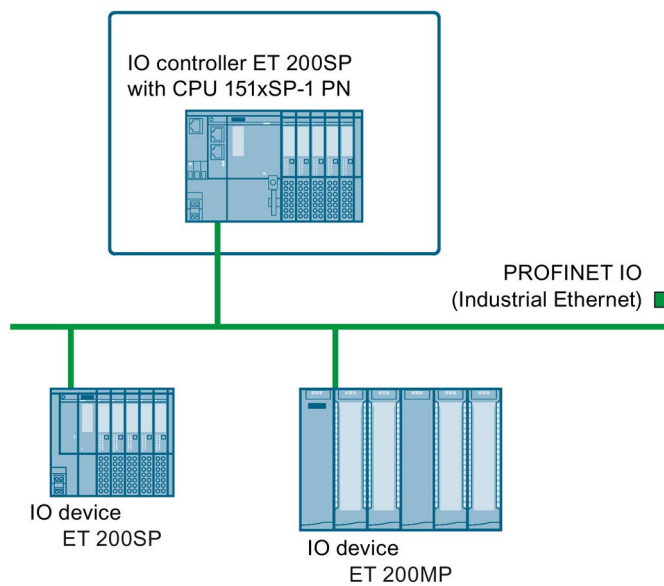


Figure 10-1 ET 200SP CPU as an IO controller

Commissioning procedure

To commission the ET 200SP distributed I/O system CPU as an IO controller for PROFINET IO, we recommend the following procedure:

Table 10- 1 Procedure for commissioning the ET 200SP CPU as an IO controller for PROFINET IO

Step	Procedure	See ...
1	Installing ET 200SP	Section Installation (Page 39)
2	Connecting ET 200SP <ul style="list-style-type: none"> • Supply voltages • PROFINET IO • Sensors and actuators 	Section Wiring (Page 49)
3	Inserting a SIMATIC memory card in the IO controller	Section Removing/inserting a SIMATIC memory card on the CPU (Page 180)
4	Configuring the IO controller ¹	Section Configuring (Page 97)
5	Switching on supply voltages for the IO controller	CPU 15xxSP-1 PN (http://support.automation.siemens.com/WW/view/en/90466439/133300) manual
6	Switching on supply voltages for IO devices	Documentation of the IO device
7	Downloading the configuration to the IO controller	STEP 7 online help
8	Switching IO controller to RUN mode	CPU 15xxSP-1 PN (http://support.automation.siemens.com/WW/view/en/90466439/133300) manual
9	Checking LEDs	CPU 15xxSP-1 PN (http://support.automation.siemens.com/WW/view/en/90466439/133300) manual
10	Testing inputs and outputs	The following functions are helpful: Monitoring and modifying tags, testing with program status, forcing, controlling the outputs. See section Test functions and eliminating problems (Page 224)

¹ The IO devices are configured with the IO controller.

10.2.2 ET 200SP CPU as an I-device

Configuration example

You need the CPU 151xSP-1 PN to use the ET 200SP distributed I/O system as an I-device.

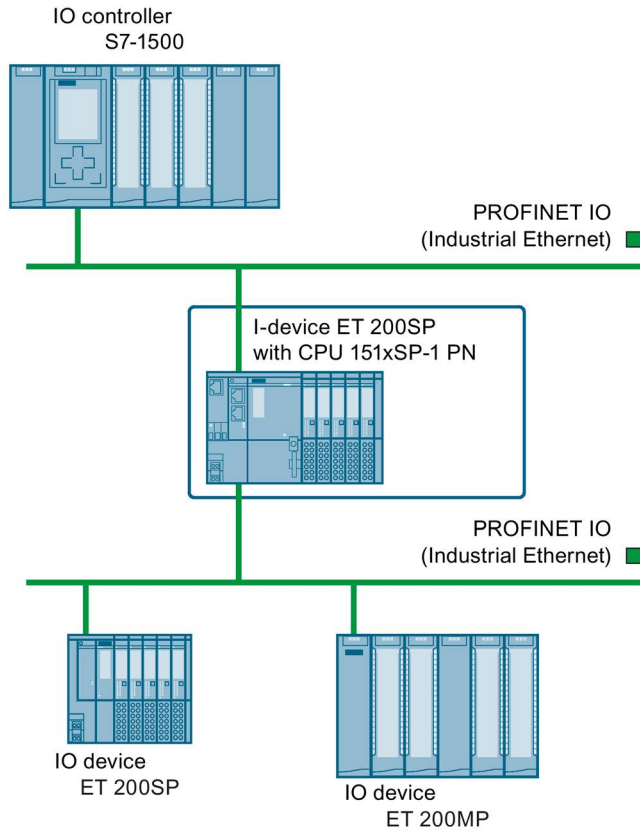


Figure 10-2 ET 200SP CPU as an I-device

Commissioning procedure

For commissioning of the ET 200SP distributed I/O system as an I-device on the PROFINET IO, we recommend the following procedure:

Table 10- 2 Procedure for commissioning the ET 200SP as an I-device on the PROFINET IO

Step	Procedure	See ...
1	Installing ET 200SP	Section Installation (Page 39)
2	Connecting ET 200SP <ul style="list-style-type: none"> • Supply voltages • PROFINET IO • Sensors and actuators 	Section Wiring (Page 49)
3	Inserting a SIMATIC memory card in the I-device	Section Removing/inserting a SIMATIC memory card on the CPU (Page 180)
4	Configuring the I-device	Section Configuring (Page 97)
5	Switching on supply voltages for the IO controller	Documentation of the IO controller
6	Switching on supply voltages for I-device and IO devices	CPU 15xxSP-1 PN (http://support.automation.siemens.com/WW/view/en/90466439/133300) manual and documentation of the IO devices
7	Download configuration to the I-device	STEP 7 online help
8	Switching IO controller and I-device to RUN mode	Documentation of the IO controller and CPU 15xxSP-1 PN (http://support.automation.siemens.com/WW/view/en/90466439/133300) manual
9	Checking LEDs	CPU 15xxSP-1 PN (http://support.automation.siemens.com/WW/view/en/90466439/133300) manual
10	Testing inputs and outputs	The following functions are helpful: Monitoring and modifying tags, testing with program status, forcing, controlling the outputs. See section Test functions and eliminating problems (Page 224)

10.2.3 ET 200SP as an IO device

Configuration example

To use the ET 200SP distributed I/O system as an IO device, you need the IM 155-6 PNxx interface module.

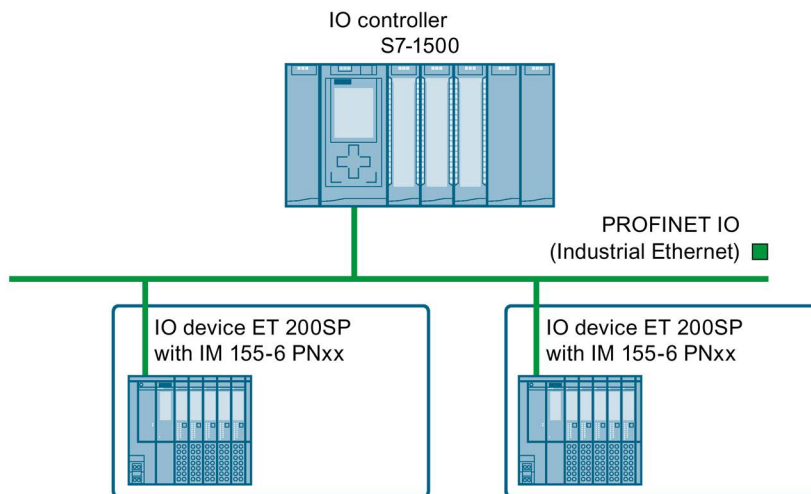


Figure 10-3 ET 200SP as an IO device

Commissioning procedure

For commissioning of the ET 200SP distributed I/O system as an IO device on the PROFINET IO, we recommend the following procedure:

Table 10- 3 Procedure for commissioning the ET 200SP as an IO device for PROFINET IO

Step	Procedure	See ...
1	Installing ET 200SP	Section Installation (Page 39)
2	Connecting ET 200SP <ul style="list-style-type: none"> • Supply voltages • PROFINET IO • Sensors and actuators 	Section Wiring (Page 49)
4	Configuring IO controller	Documentation of the IO controller
5	Switching on supply voltages for the IO controller	Documentation of the IO controller
6	Switching on supply voltages for IO devices	Interface module http://support.automation.siemens.com/WW/view/en/55683316/133300 Manual
7	Downloading the configuration to the IO controller	STEP 7 online help
8	Switching IO controller to RUN mode	Documentation of the IO controller

Step	Procedure	See ...
9	Checking LEDs	Interface module (http://support.automation.siemens.com/WW/view/en/55683316/133300) Manual
10	Testing inputs and outputs	The following functions are helpful: Monitoring and modifying tags, testing with program status, forcing, controlling the outputs. Refer to section Test functions and eliminating problems (Page 224)

10.3 Commissioning the ET 200SP on PROFIBUS DP

Requirements

- The CPU/interface module is in the "Factory settings" status or has been reset to factory settings (see section Interface module (<http://support.automation.siemens.com/WW/view/en/55683316/133300>)).
- For CPU: The SIMATIC memory card is as delivered or has been formatted.

10.3.1 ET 200SP as a DP master

Configuration example

To use the ET 200SP distributed I/O system as a DP master, you need the CPU 151xSP-1 PN and the CM DP communication module.

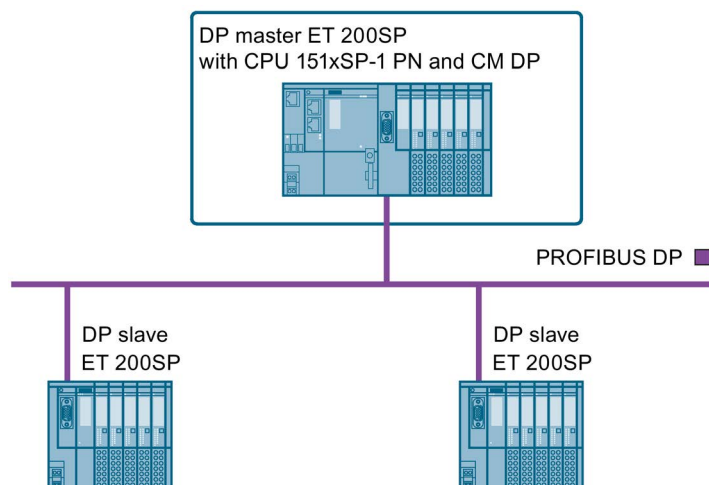


Figure 10-4 ET 200SP as a DP master

Commissioning procedure

To commission the ET 200SP distributed I/O system as a DP master on PROFIBUS DP, we recommend the following procedure:

Table 10-4 Procedure for commissioning the ET 200SP as a DP master on the PROFIBUS DP

Step	Procedure	See ...
1	Installing ET 200SP (with CPU and CM DP)	Section Installation (Page 39)
2	Connecting ET 200SP <ul style="list-style-type: none"> • Supply voltages • PROFIBUS DP • Sensors and actuators 	Section Wiring (Page 49)
3	Inserting a SIMATIC memory card in the DP master (CPU)	Section Removing/inserting a SIMATIC memory card on the CPU (Page 180)
4	Configuring DP master (including PROFIBUS address)	CPU 15xxSP-1 PN (http://support.automation.siemens.com/WW/view/en/90466439/133300) and CM DP manual
5	Switching on supply voltages for DP master	CPU 15xxSP-1 PN (http://support.automation.siemens.com/WW/view/en/90466439/133300) manual
6	Switching on supply voltages for DP slaves	Documentation of the DP slave
7	Download configuration to the DP master	STEP 7 online help
8	Switching DP master to RUN	CPU 15xxSP-1 PN (http://support.automation.siemens.com/WW/view/en/90466439/133300) manual
9	Checking LEDs	CPU 15xxSP-1 PN (http://support.automation.siemens.com/WW/view/en/90466439/133300) manual
10	Testing inputs and outputs	The following functions are helpful: Monitoring and modifying tags, testing with program status, forcing, controlling the outputs. See section Test functions and eliminating problems (Page 224)

10.3.2 ET 200SP as I-slave

Configuration example

To use the ET 200SP distributed I/O system as I-slave, you need the CPU 151xSP-1 PN and the CM DP communication module.

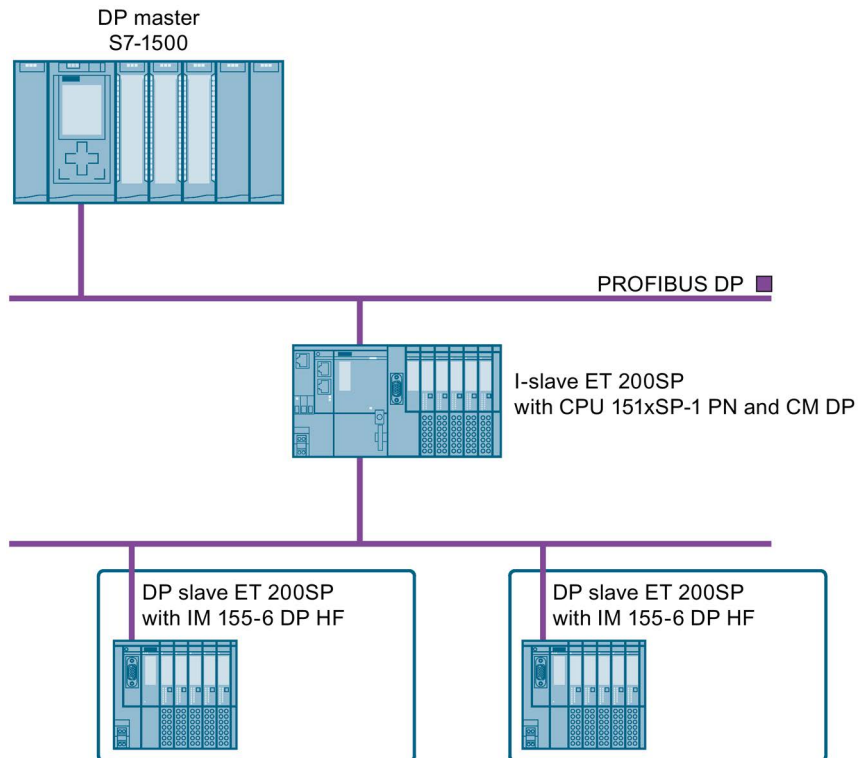


Figure 10-5 ET 200SP as I-slave

Commissioning procedure

For commissioning of the ET 200SP distributed I/O system as an I-slave on the PROFIBUS DP, we recommend the following procedure:

Table 10- 5 Procedure for commissioning the ET 200SP as an I-slave for PROFIBUS DP

Step	Procedure	See ...
1	Installing ET 200SP (with CPU and CM DP)	Section Installation (Page 39)
2	Connecting ET 200SP <ul style="list-style-type: none"> • Supply voltages • PROFIBUS DP • Sensors and actuators 	Section Wiring (Page 39)
3	Configuring DP master (including PROFIBUS address)	Documentation of the DP master
4	Inserting a SIMATIC memory card in the I-slave (CPU)	Section Removing/inserting a SIMATIC memory card on the CPU (Page 180)
5	Configuring I-slave (including PROFIBUS address)	CPU 15xxSP-1 PN (http://support.automation.siemens.com/WW/view/en/90466439/133300) and CM DP manual
6	Switching on supply voltages for DP master	Documentation of the DP master
7	Switching on supply voltages for I-slaves	CPU 15xxSP-1 PN (http://support.automation.siemens.com/WW/view/en/90466439/133300) manual
8	Loading configuration in the DP master and I-slaves	STEP 7 online help
9	Switching DP master and I-slaves to RUN	Documentation of the DP master and CPU 15xxSP-1 PN (http://support.automation.siemens.com/WW/view/en/90466439/133300) manual
10	Checking LEDs	CPU 15xxSP-1 PN (http://support.automation.siemens.com/WW/view/en/90466439/133300) manual
11	Testing inputs and outputs	The following functions are helpful: Monitoring and modifying tags, testing with program status, forcing, controlling the outputs. See the Test functions and fault resolution (http://support.automation.siemens.com/WW/view/en/90466439/133300) section

See also

Wiring (Page 49)

10.3.3 ET 200SP as a DP slave

Configuration example

To use the ET 200SP distributed I/O system as a DP slave, you need the IM 155-6 DP HF.

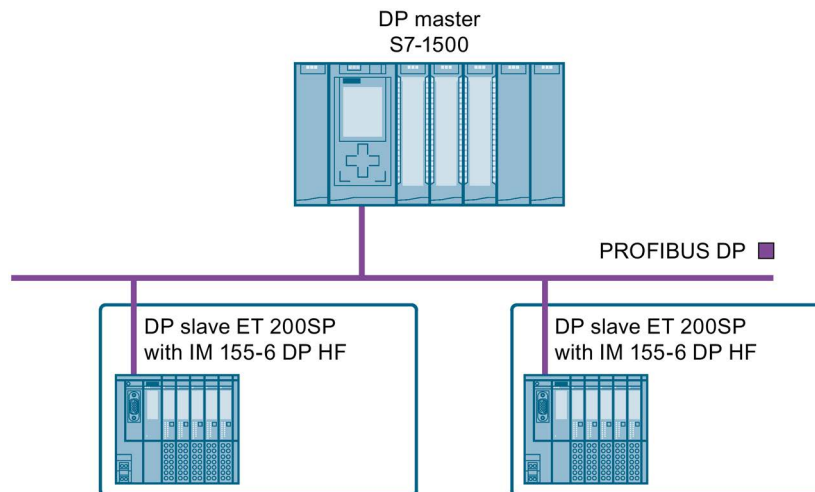


Figure 10-6 ET 200SP as a DP slave

Commissioning procedure

To commission the ET 200SP distributed I/O system as a DP slave on PROFIBUS DP, we recommend the following procedure:

Table 10- 6 Procedure for commissioning the ET 200SP as a DP master for PROFIBUS DP

Step	Procedure	See ...
1	Installing ET 200SP (with IM 155-6 DP HF)	Section Installation (Page 39)
2	Setting the PROFIBUS address on the interface module	Section Interface module (http://support.automation.siemens.com/W/view/en/55683316/133300)
3	Connecting ET 200SP <ul style="list-style-type: none"> • Supply voltages • PROFIBUS DP • Sensors and actuators 	Section Wiring (Page 49)
4	Configuring DP master (including PROFIBUS address)	Documentation of the DP master
5	Switching on supply voltages for DP master	Documentation of the DP master
6	Switching on supply voltages for DP slaves	Interface module (http://support.automation.siemens.com/W/view/en/55683316/133300) Manual

Step	Procedure	See ...
7	Download configuration to the DP master	STEP 7 online help
8	Switching DP master to RUN	Documentation of the DP master
9	Checking LEDs	Interface module (http://support.automation.siemens.com/W/view/en/55683316/133300) Manual
10	Testing inputs and outputs	The following functions are helpful: Monitoring and modifying tags, testing with program status, forcing, controlling the outputs. Refer to section Test functions and eliminating problems (Page 224)

10.4 Startup of the ET 200SP with empty slots

Procedure

You can configure the ET 200SP distributed I/O system with any number of empty slots.

To build the ET 200SP distributed I/O system with any number of empty slots, follow these steps:

1. Cover all empty slots with BU covers.
2. Finish the configuration with a server module.

Special consideration: A "Module missing in slot x" diagnostic message is generated by the CPU/interface module for empty slots in which I/O modules are configured.

10.5 Removing/inserting a SIMATIC memory card on the CPU

Requirement

The CPU only supports pre-formatted SIMATIC memory cards. If necessary, delete all previously stored data before using the SIMATIC memory card. Additional information about deleting the contents of the SIMATIC memory card can be found in the section, SIMATIC memory card - overview (Page 196).

In order to work with the SIMATIC memory card, first ensure that the SIMATIC memory card is not write-protected. If it is, move the slider out of the lock position.

Inserting the SIMATIC memory card

To insert a SIMATIC memory card, follow these steps:

1. Ensure that the CPU is either switched off or in STOP mode.
2. Insert the SIMATIC memory card, as depicted on the CPU, into the slot for the SIMATIC memory card.

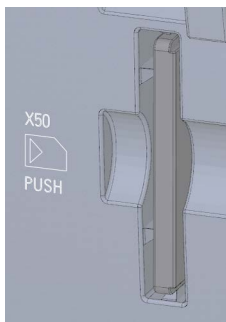


Figure 10-7 Slot for the SIMATIC memory card

3. Insert the SIMATIC memory card with light pressure into the CPU, until the SIMATIC memory card latches.

Removing the SIMATIC memory card

To remove a SIMATIC memory card, follow these steps:

1. Switch the CPU to STOP mode.
2. Press the SIMATIC memory card into the CPU with light pressure. After audible unlatching of the SIMATIC memory card, remove it.

Reactions after removing/inserting the SIMATIC memory card

Inserting and removing the SIMATIC memory card in STOP, STARTUP or RUN mode triggers a re-evaluation of the SIMATIC memory card. The CPU compares the content of the configuration on the SIMATIC memory card with the backed-up retentive data. If the backed-up retentive data matches the data of the configuration on the SIMATIC memory card, the retentive data is retained. If the data differs, the CPU automatically performs a memory reset (which means the retentive data is deleted) and then goes to STOP.

The CPU evaluates the SIMATIC memory card and indicates this by the RUN/STOP LED flashing.

Reference

Additional information on the SIMATIC memory card can be found in the section SIMATIC memory card (Page 196).

10.6 Operating modes of the CPU

Introduction

Operating modes describe the status of the CPU. The following operating modes are possible using the mode selector:

- STARTUP
- RUN
- STOP

In these operating modes, the CPU can communicate, for example, via the PROFINET interface.

The status LEDs on the front of the CPU indicate the current operating mode.

10.6.1 STARTUP mode

Function

Before the CPU starts to execute the cyclic user program, a startup program is executed.

By suitably programming startup OBs, you can specify initialization tags for your cyclic program in the startup program. You have the option of programming no, one or several startup OBs.

Special features during startup

Note the following points regarding the STARTUP mode:

- All outputs are disabled or react according to the parameter settings for the particular I/O module: They provide a substitute value as set in the parameters or retain the last value output and bring the controlled process to a safe operational status.
- The process image is initialized.

The process image is not updated.

In order to read the current state from inputs during STARTUP, you can access inputs directly via I/O access.

In order to initialize outputs during STARTUP, values can be written via the process image or via direct I/O access. The values are output at the outputs during the transition to the RUN mode.

- The CPU always starts up in warm restart mode.
 - The non-retentive bit memory, timers and counters are initialized.
 - The non-retentive tags in data blocks are initialized.
- During startup, cycle time monitoring is not yet running

- The startup OBs are executed in the order of the startup OB numbers. All startup OBs that you have programmed are executed, regardless of the selected startup mode.
- The following OBs can be started during startup, if a corresponding event occurs:
 - OB 82: Diagnostics interrupt
 - OB 83: Pull/plug interrupt for modules
 - OB 86: Rack error
 - OB 121: Programming error (only for global error handling)
 - OB 122: I/O access error (only for global error handling)You can find a description of how to use global and local error handling in the STEP 7 online help.

No other OBs can be started until after the transition to RUN mode.

Response when expected and actual configurations do not match

The configuration downloaded to the CPU represents the expected configuration. The actual configuration is the actual configuration of the ET 200SP distributed I/O system. If the expected configuration and the actual configuration do not match, the setting of the "Comparison preset to actual configuration" parameter determines the reaction of the CPU (see section Operating mode transitions (Page 186)).

Canceling a startup

If errors occur during startup, the CPU cancels the startup and returns to STOP mode.

The CPU does not execute a startup or cancels a startup under the following conditions:

- If no SIMATIC memory card is inserted or an invalid SIMATIC memory card is inserted.
- If no hardware configuration has been downloaded.

Setting the startup behavior

To set the startup behavior, follow these steps:

1. In the device view of the STEP 7 hardware network editor, select the CPU.
2. In the properties under "General" select the "Startup" area.

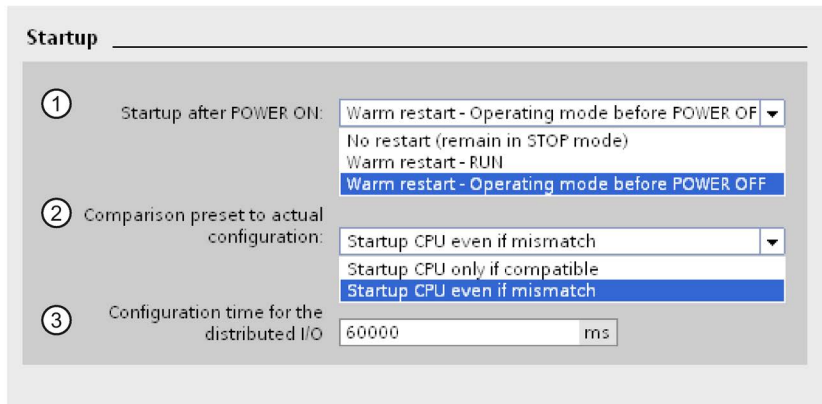


Figure 10-8 Setting the startup behavior

- ① Sets the startup type after POWER ON
- ② Defines the startup behavior when a module in a slot does not correspond to the configured module. You can set this parameter centrally, on the CPU or for each module. When you change the setting for a module, the setting made centrally for this module no longer applies.
 - Startup CPU only if compatible: In this setting a module on a configured slot has to be compatible with the configured module. Compatible means that the module matches in terms of the number of inputs and outputs and with respect to its electrical and functional properties.
 - Startup CPU even if mismatch: With this setting the CPU starts up regardless of the type of module plugged in.
- ③ Specifies a maximum period (default: 60000 ms) in which the I/O must be ready for operation. The CPU changes to RUN.
If the central and distributed I/O is not ready for operation within the configuration time, the startup characteristics of the CPU depends on the setting of the "Comparison preset to actual configuration" parameter.

Example for the "Comparison preset to actual configuration" parameter

"Startup CPU only if compatible":

The input module DI 16x24VDC ST with 16 digital inputs is a compatible replacement for the input module DI 8x24VDC ST with 8 digital inputs, because the pin assignment and all the electrical and functional properties match.

"Startup CPU even if mismatch":

Instead of a configured digital input module, you insert an analog output module or no module is present in this slot and thus in all subsequent slots. Although the configured inputs cannot be accessed, the CPU starts up.

Note that the user program cannot function correctly in this case and take the appropriate measures.

10.6.2 STOP mode

Function

The CPU does not execute the user program in STOP mode.

All outputs are disabled or react according to the parameter settings for the particular I/O module: They provide a substitute value as set in the parameters or retain the last value output keeping the controlled process in a safe operating status.

10.6.3 RUN mode

Function

In "RUN" mode the cyclic, time-driven, and interrupt-driven program is executed. Addresses that are in the "Automatic Update" process image are automatically updated in each program cycle. See also the section Process images and process image partitions (Page 104).

Execution of the user program

Once the CPU has read the inputs, the cyclic program is executed from the first instruction to the last instruction.

If you have configured a minimum cycle time, the CPU will not end the cycle until this minimum cycle time is finished even if the user program is completed sooner.

A cycle monitoring time is set to ensure that the cyclic program is completed within a specified time. You can change the cycle monitoring time to suit your requirements. If the cyclic program has not finished running within this time, the system responds with a time error.

Further events such as hardware interrupts and diagnostics interrupts can interrupt the cyclic program flow and prolong the cycle time.

Reference

Further information about cycle and response times is available in the Function Manual Cycle and response times (<http://support.automation.siemens.com/WW/view/en/59193558>).

10.6.4 Operating mode transitions

Operating modes and operating mode transitions

The following figure shows the operating modes and the operating mode transitions:

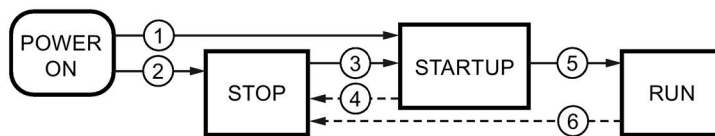


Figure 10-9 Operating modes and operating mode transitions

The table below shows the effects of the operating mode transitions:

Table 10- 7 Operating mode transitions

No.	Operating mode transitions	Effect	
①	POWER ON → STARTUP	After switching on, the CPU switches to "STARTUP" mode if: <ul style="list-style-type: none"> • The hardware configuration and program blocks are consistent. • The "Warm restart-RUN" startup type is set or <ul style="list-style-type: none"> • The "Warm restart mode before POWER OFF" is set and was in RUN mode before POWER OFF. 	Non-retentive memory is cleared, and the content of non-retentive DBs is reset to the start values of the load memory. Retentive memory and retentive DB contents are retained.
②	POWER ON → STOP	After switching on, the CPU goes to "STOP" mode if: <ul style="list-style-type: none"> • The hardware configuration and program blocks are inconsistent or <ul style="list-style-type: none"> • The "No restart" startup type is set. 	Non-retentive memory is cleared, and the content of non-retentive DBs is reset to the start values of the load memory. Retentive memory and retentive DB contents are retained.
③	STOP → STARTUP	The CPU switches to "STARTUP" mode if: <ul style="list-style-type: none"> • The hardware configuration and program blocks are consistent. • The programming device sets the CPU to "RUN" and the mode selector is in the RUN setting or <ul style="list-style-type: none"> • The mode selector is switched from STOP to RUN. 	Non-retentive memory is cleared, and the content of non-retentive DBs is reset to the start values of the load memory. Retentive memory and retentive DB contents are retained.

No.	Operating mode transitions		Effect
④	STARTUP → STOP	The CPU returns to the "STOP" mode in the following cases of "STARTUP": <ul style="list-style-type: none"> • The CPU detects an error during startup. • The programming device or the mode selector sets the CPU to "STOP". • A STOP command is executed in the Startup OB. 	
⑤	STARTUP → RUN	The CPU goes to the "RUN" mode in the following cases of "START-UP": <ul style="list-style-type: none"> • The CPU has initialized the PLC tags. • The CPU has executed the startup blocks successfully. 	
⑥	RUN → STOP	The CPU returns to the "STOP" mode in the following cases of "RUN": <ul style="list-style-type: none"> • An error is detected that prevents continued processing. • A STOP command is executed in the user program. • The programming device or the mode selector sets the CPU to "STOP". 	

10.7 CPU memory reset

Basics of a memory reset

A memory reset on the CPU is possible only in the STOP mode.

When memory is reset, the CPU is changed to a so-called "initial status".

This means that:

- An existing online connection between your programming device/PC and the CPU is terminated.
- The content of the work memory and the retentive and non-retentive data (applies only to manual memory reset by the user) are deleted.
- The diagnostics buffer, time of day, and IP address are retained.
- Subsequently the CPU is initialized with the loaded project data (hardware configuration, code and data blocks, force jobs). The CPU copies this data from the load memory to the work memory.

Result:

- If you set an IP address in the hardware configuration ("Set IP address in the project" option) and a SIMATIC memory card with the project is in the CPU, this IP address is valid after the memory reset.
- Data blocks no longer have current values but rather their configured start values.
- Force jobs remain active.

How can I tell if the CPU is performing a memory reset?

The RUN/STOP LED flashes yellow at 2 Hz. After completion the CPU goes into STOP mode, and the RUN/STOP LED is switched on (permanently lit yellow).

Result after memory reset

The following table provides an overview of the contents of the memory objects after memory reset.

Memory object	Content
Actual values of the data blocks, instance data blocks	Initialized
Bit memory, timers and counters	Initialized
Retentive tags from technology objects (for example, adjustment values of absolute encoders)*	Retained
Diagnostics buffer entries (retentive area)	Retained
Diagnostics buffer entries (non-retentive area)	Initialized
IP address	Retained
Counter readings of the runtime meters	Retained
Time of day	Retained

* The retentive tags from technology objects are retained but the content of specific tags is partly re-initialized.

10.7.1 Automatic memory reset

Possible cause of an automatic memory reset

The CPU executes an automatic memory reset if an error occurs that prevents normal further processing.

Causes for such errors can be:

- User program is too large, and cannot be completely loaded into work memory.
- The project data on the SIMATIC memory card is corrupt, for example, because a file was deleted.
- If you remove or insert the SIMATIC memory card and the backed-up retentive data differs in structure from that of the configuration on the SIMATIC memory card.

10.7.2 Manual memory reset

Reason for a manual memory reset

A memory reset is required to reset the CPU to its "original state".

CPU memory reset

There are two options for performing a CPU memory reset:

- Using the mode selector
- Using STEP 7

Procedure using the mode selector

Note

Memory reset ↔ Reset to factory settings

The operation described below also reflects the procedure for resetting to factory settings:

- Selector operation with inserted SIMATIC memory card: CPU executes a memory reset
 - Selector operation without inserted SIMATIC memory card: CPU executes reset to factory settings
-

To reset the CPU memory using the mode selector, proceed as follows:

1. Set the mode selector to the STOP position.
Result: The RUN/STOP LED lights up yellow.
2. Set the mode selector to the MRES position. Hold the selector in this position until the RUN/STOP LED lights up for the 2nd time and remains continuously lit (this takes three seconds). After this, release the switch.
3. Within the next three seconds, switch the mode selector back to the MRES position, and then back to STOP again.

Result: The CPU executes memory reset.

Procedure using STEP 7

For a memory reset of the CPU using STEP 7 proceed as follows:

1. Open the "Online Tools" task card of the CPU.
2. Click the "MRES" button in the "CPU control panel" pane.
3. Click "OK" in response to the confirmation prompt.

Result: The CPU switches to STOP mode and performs a memory reset.

10.8 Reassigning parameters during operation

Introduction

You have the option of reassigning the parameters for the ET 200SP I/O modules during operation.

Changing parameters during operation

You make the parameter settings of the I/O modules using data records. Each I/O module has a separate data record. The instruction "WRREC" applies the changed parameters to the I/O module.

If you are using the CPU as an I-device, you reassign the parameters of the I/O modules via the I-device.

Note

If you write data records from the user program to the modules of the distributed I/O, make sure that these modules actually exist and are available. You can evaluate OB83 for this purpose. After inserting a module, the CPU does not call OB83 until the module has started up and its parameters are assigned. This ensures the execution of the data record operations without errors.

Note

You need to transfer the new parameters with the "WRREC" instruction after a POWER OFF/POWER ON of the ET 200SP.

Instruction for parameter assignment

The following instruction is provided for assigning parameters to the I/O module in the user program:

Instruction	Application
"WRREC"	Transfer the modifiable parameters to the addressed ET 200SP module.

Error message

In the event of an error, the following return values are reported:

Table 10- 8 Error message

Error code	Meaning
80E0 _H	Error in header information
80E1 _H	Parameter error

Reference

You will find the setup of the parameter data record in the manuals of the I/O modules (<http://support.automation.siemens.com/WW/view/es/55679691/133300>).

10.9 Identification and maintenance data

10.9.1 Reading out and entering I&M data

I&M data

I&M identification data is information which is stored on the module either as read-only data (I-data) or read/write data (M-data).

Identification data (I&M0): Manufacturer information about the module that can only be read and is in part also printed on the housing of the module, for example, article number and serial number.

Maintenance data (I&M1, 2, 3): Plant-dependent information, e.g. installation location. Maintenance data is created during configuration and written to the module.

All modules of the ET 200SP distributed I/O system support identification data (I&M0 to I&M3).

The I&M identification data supports you in the following activities:

- Checking the plant configuration
- Locating hardware changes in a plant
- Correcting errors in a plant

Modules can be clearly identified online using the I&M identification data.

STEP 7 allows you to read the identification I&M data (see STEP 7 online help).

Note

The BusAdapter and the interface module IM 155-6 PN HF support the identification data I&M0 to I&M4 (signature).

Options for reading out I&M data

- Via the user program
- Using STEP 7 or HMI devices
- Via the Web server of the CPU

Procedure for reading I&M data by means of the user program

In order to read the I&M data of the modules in the user program, use the RDREC instruction.

The data record structure for modules that are distributed and accessible via PROFINET IO/ PROFIBUS DP is described in the section Structure of the data record for I&M data (Page 193).

Procedure for reading the I&M data using STEP 7

Requirements: There must be an online connection to the CPU/interface module.

To read I&M data using STEP 7, follow these steps:

1. In the project tree, under "Distributed I/O" select the IO device IM 155-6 PN ST (for example).
2. Select > **IO device > Online & diagnostics > Identification & Maintenance.**

Procedure for input of maintenance data using STEP 7

STEP 7 assigns a default module name. You can enter the following information:

- Plant designation (I&M1)
- Location identifier (I&M1)
- Installation date (I&M2)
- Additional information (I&M3)

To enter maintenance data via STEP 7, follow these steps:

1. In the device view of the STEP 7 hardware network editor, select the interface module, for example.
2. In the properties under "General", select the "Identification & Maintenance" area and enter the data.

During the loading of the hardware configuration, the I&M data is also loaded.

Procedure for reading I&M data via the web server

The procedure is described in detail in the Web server (<http://support.automation.siemens.com/WW/view/en/59193560>) Function Manual.

10.9.2 Data record structure for I&M data

Reading I&M data records (distributed via PROFINET IO)

You can directly access specific identification data by selecting **Read data record** (RDREC instruction). You obtain the corresponding part of the identification data under the relevant data record index.

The data records are structured as follows:

Table 10- 9 Basic structure of data records with I&M identification data

Content	Length (bytes)	Coding (hex)
Header information		
BlockType	2	I&M0: 0020 _H I&M1: 0021 _H I&M2: 0022 _H I&M3: 0023 _H
BlockLength	2	I&M0: 0038 _H I&M1: 0038 _H I&M2: 0012 _H I&M3: 0038 _H
BlockVersionHigh	1	01
BlockVersionLow	1	00
Identification data		
Identification data (see table below)	I&M0/Index AFF0 _H : 54 I&M1/Index AFF1 _H : 54 I&M2/Index AFF2 _H : 16 I&M3/Index AFF3 _H : 54	

Table 10- 10 Data record structure for I&M identification data

Identification data	Access	Default	Explanation
Identification data 0: (data record index AFF0 hex)			
VendorIDHigh	Read (1 byte)	00 _H	This is where the name of the manufacturer is stored (42 _D = SIEMENS AG).
VendorIDLow	Read (1 byte)	2A _H	
Order_ID	Read (20 bytes)	6ES7155-6AU00-0BN0	Article number of the module (e.g. of the interface module)
IM_SERIAL_NUMBER	Read (16 bytes)	-	Serial number (device-specific)
IM_HARDWARE_REVISION	Read (2 bytes)	1	Corresponding HW version
IM_SOFTWARE_REVISION	Read	Firmware version	Provides information about the firmware version of the module
• SWRevisionPrefix	(1 byte)	V	
• IM_SWRevision_Functional_Enhancement	(1 byte)	00 - FF _H	
• IM_SWRevision_Bug_Fix	(1 byte)	00 - FF _H	

Identification data	Access	Default	Explanation
<ul style="list-style-type: none"> IM_SWRevision_Internal_Change 	(1 byte)	00 - FF _H	
IM_REVISION_COUNTER	Read (2 bytes)	0000 _H	Provides information about parameter changes on the module (not used)
IM_PROFILE_ID	Read (2 bytes)	0000 _H	Generic Device
IM_PROFILE_SPECIFIC_TYPE	Read (2 bytes)	0005 _H	Interface module/bus adapter
		0003 _H	I/O modules
		0001 _H	CPU
IM_VERSION	Read	0101 _H	Provides information on the version of the identification data (0101 _H = Version 1.1)
<ul style="list-style-type: none"> IM_Version_Major 	(1 byte)		
<ul style="list-style-type: none"> IM_Version_Minor 	(1 byte)		
IM_SUPPORTED	Read (2 bytes)	000E _H	Provides information about the available identification data (I&M1 to I&M3)
Maintenance data 1: (data record index AFF1 hex)			
IM_TAG_FUNCTION	Read/write (32 bytes)	-	Enter a module identifier here that is unique plant-wide.
IM_TAG_LOCATION	Read/write (22 bytes)	-	Enter the installation location of the module here.
Maintenance data 2: (data record index AFF2 hex)			
IM_DATE	Read/write (16 bytes)	YYYY-MM-DD HH:MM	Enter the installation date of the module here.
Maintenance data 3: (data record index AFF3 hex)			
IM_DESCRIPTOR	Read/write (54 bytes)	-	Enter a comment describing the module.

Reading I&M data records with data record 255 (distributed via PROFIBUS DP)

The modules support standardized access to identification data via DS 255 (index 65000 to 65003). For further information on the DS 255 data structure, refer to the specifications of the Profile Guidelines Part 1: Identification & Maintenance Functions - Order No.: 3.502, version 1.2 dated October 2009.

10.10 Shared commissioning of projects

Team Engineering

In Team Engineering several users from various engineering systems work on a project at the same time and access one ET 200SP CPU.

The users can edit separate parts of a master project independently of one another at the same time. The changes of the other editors are displayed in a synchronization dialog during the loading of the configuration in the CPU and synchronized automatically, if possible.

Certain online functions can also be executed at the same time from several engineering systems on a shared CPU, such as:

- Monitoring blocks on the CPU
- Modifying blocks on the CPU
- Trace functions

You can find detailed information on the topic of Team Engineering in the STEP 7 online help.

SIMATIC memory card

11.1 SIMATIC memory card - overview

Introduction

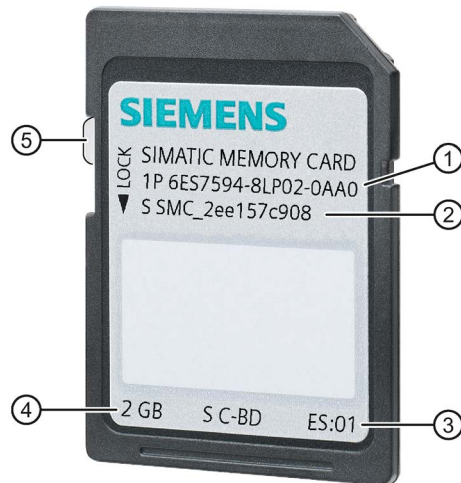
The CPU uses a SIMATIC memory card as the program memory. The SIMATIC memory card is a preformatted memory card compatible with the Windows file system. The memory card is available in different memory sizes and can be used for the following purposes:

- Transportable data carrier
- Program card
- Firmware update card
- Service data card

A commercially available SD card reader is required to write/read the SIMATIC memory card with the programming device/PC. This is used, for example, to copy files directly to the SIMATIC memory card using the Windows Explorer.

The SIMATIC memory card is mandatory to operate the CPU.

Labeling of the SIMATIC memory card



- ① Article number
- ② Serial number
- ③ Product version
- ④ Memory size
- ⑤ Slider for enabling write protection:
 - Slider up: not write-protected
 - Slider down: write-protected

Figure 11-1 Labeling of the SIMATIC memory card

Folders and files on the SIMATIC memory card

The following folders and files can be found on the SIMATIC memory card:

Table 11- 1 Folder structure

Folder	Description
FWUPDATE.S7S	Firmware update files for CPU and I/O modules
SIMATIC.S7S	User program, i.e. all blocks (OBs, FCs, FBs, DBs) and system blocks, project data of the CPU
SIMATIC.HMI	HMI-relevant data
DataLogs	DataLog files
Recipes	Recipe files

Table 11- 2 File structure

File type	Description
S7_JOB.S7S	Job file
SIMATIC.HMI\Backup*.psb	Panel backup files
SIMATICHMI_Backups_DMS.bin	Protected file (required to use panel backup files in STEP 7)
__LOG__	Protected system file (required in order to use the card)
crdinfo.bin	Protected system file (required in order to use the card)
DUMP.S7S	Service data file
*.pdf, *.txt, *.csv, etc.	Additional files with different formats that you can also store in folders of the SIMATIC memory card

Use the serial number for copy protection

You can set up copy protection for CPUs which binds execution of the block to a specific SIMATIC memory card. Configuration is carried out in STEP 7 in the properties of the block "Bind to serial number of the SIMATIC memory card".

The user can then only execute the block if it is on the SIMATIC memory card with the specified serial number.

Removing a SIMATIC memory card

Only remove the SIMATIC memory card in the POWER OFF or STOP state of the CPU. Make sure that no writing functions (e.g. loading/deleting a block) are active in STOP mode, or were active at POWER OFF. To do this, disconnect the communication connections.

If you remove the SIMATIC memory card during a write process, the following problems can occur:

- The data contents of a file are incomplete.
- The file is no longer readable, or no longer exists.
- The entire content of the card is corrupted.

Removing the SIMATIC memory card from the CPU in STOP, STARTUP or RUN mode triggers a re-evaluation of the SIMATIC memory card. The CPU compares the content of the configuration on the SIMATIC memory card with the backed-up retentive data. If the backed-up retentive data matches the data of the configuration on the SIMATIC memory card, the retentive data is retained. If the data differs, the CPU automatically performs a memory reset (which means the CPU deletes the retentive data) and then goes to STOP.

Removing a SIMATIC memory card from Windows computers

If you are using the card in a commercially available card reader under Windows, use the "Eject" function before you remove the card from the card reader. If you remove the card without using the "Eject" function, you may lose data.

Deleting the contents of the SIMATIC memory card

You have the following options for deleting the content of the SIMATIC memory card:

- Delete files using Windows Explorer
- Format with STEP 7

Note

If you format the card with Windows utilities, you will render the SIMATIC memory card unusable as a storage medium for a CPU.

Deletion of files and folders is permitted, with the exception of the "__LOG__" and "crdinfo.bin" system files. The CPU needs these system files. When you delete the files, you will no longer be able to use the SIMATIC memory card with the CPU.

If you have deleted the "__LOG__" and "crdinfo.bin" system files, format the SIMATIC memory card as described in the following section.

Formatting a SIMATIC memory card

Note

Formatting of a SIMATIC memory card may only be carried out in a CPU; otherwise the SIMATIC memory card cannot be used in the CPU.

If you want to format the SIMATIC memory card using STEP 7, an online connection to the relevant CPU must exist. The CPU is in STOP mode.

Proceed as follows to format a SIMATIC memory card:

1. Open the Online and Diagnostics view of the CPU (either from the project context or via "Accessible devices").
2. In the "Functions" folder, select the "Format memory card" group.
3. Click the "Format" button.
4. Click "Yes" in response to the confirmation prompt.

Result:

- The SIMATIC memory card is formatted for use in the CPU.
- The data on the CPU is deleted with the exception of the IP address.

Service life of a SIMATIC memory card

The service life of a SIMATIC memory card depends essentially on the following factors:

- Number of delete/write cycles
- External influences, such as ambient temperature

At an ambient temperature of up to 60 °C, at least 50,000 delete/write processes are possible on the SIMATIC memory card (see Technical specifications of the individual SMCs).

11.2 Setting the card type

Setting the card type

You can use the SIMATIC memory card as a program card or as a firmware update card.

Procedure

To set the card type, follow these steps:

1. To set the card type, insert the SIMATIC memory card into the card reader of the programming device.
2. Select the "SIMATIC Card Reader" folder in the project tree.
3. In the properties of the selected SIMATIC memory card, specify the card type:

- **Program card**

You use a program card as an external load memory for the CPU. It contains the entire user program for the CPU. The user program is transferred from the load memory to the work memory and runs there. When you remove the SIMATIC memory card with the user program, the CPU goes into STOP mode.

The following folder is created on the SIMATIC memory card: SIMATIC.S7

- **Firmware update card**

You can save firmware for CPUs and for I/O modules on a SIMATIC memory card. It is thus possible to perform a firmware update with the help of a specifically prepared SIMATIC memory card.

The following folder is created on the SIMATIC memory card: FWUPDATE.S7S

Reference

You can find more information on this topic in the STEP 7 online help.

11.3 Data transfer with SIMATIC memory cards

Transferring objects from the project to a SIMATIC memory card

When the SIMATIC memory card is inserted into the programming device or into an external card reader, you can transfer objects from the project tree (STEP 7) to the SIMATIC memory card as follows:

- Individual blocks (multiple selection possible)

In this case, the transfer is consistent, i.e. the function takes dependencies between blocks due to block calls into account.

- CPU folder

In this case, all runtime-relevant objects including blocks and the hardware configuration are transferred onto the SIMATIC memory card - just as when downloading.

To perform a transfer, you can transfer the objects by dragging and dropping, or use the "Card Reader/USB memory > Write to memory card" command in the "Project" menu.

Firmware update using a SIMATIC memory card

You can find information on how to perform a firmware update using a SIMATIC memory card in the section Firmware update (Page 211).

Reference

For additional information about the SIMATIC memory card, refer to the STEP 7 online help.

Maintenance

12.1 Removing and inserting I/O modules

Introduction

The ET 200SP distributed I/O system supports removal and insertion of I/O modules during operation (RUN mode).

Requirements

The following table describes which modules you may insert and remove under which conditions:

Table 12- 1 Removal and insertion of modules

Modules	Removal and insertion	Conditions
CPU	No	---
BusAdapter	No	---
CM DP module	No	---
Interface module	No	---
I/O modules	Yes	<ul style="list-style-type: none"> • Digital output modules: only when load is switched off • Digital modules: For load voltage above the safe extra-low voltage: only with switched off load voltage supply • Technology modules: only with switched off supply voltage L+ • AI Energy Meter ST: <ul style="list-style-type: none"> – only when measuring voltage on primary side is switched off, or – without the special current transformer terminal, measuring voltage and load current must be through the converters, which means the machine or the load must be switched off in the process. With the special terminal, the process can continue because the current transformer is isolated safely. However, the measuring voltage on the module at the connections UL1-UL3 still needs to be isolated.
Server module	No	---

NOTICE
Risk of hazardous system states
If you remove and insert digital output modules with the load switched on or technology modules with the supply voltage switched on, this can result in hazardous system states.
The ET 200SP distributed I/O system or the connected sensors may be damaged as a result.
Therefore, a digital output module may only be inserted and removed when the load is switched off and a technology module may only be inserted and removed when the supply voltage is switched off.

NOTICE
Risk of hazardous system states
If you remove and insert the AI Energy Meter ST with the primary-side voltage switched on at the current transformer, this can result in hazardous system states.
The ET 200SP distributed I/O system may be damaged as a result.
<ul style="list-style-type: none">• For this reason, remove and insert the AI Energy Meter ST only when the measuring voltage on the primary side is switched off or• Only when a special current transformer terminal is used which short-circuits the secondary end of the transformer when a module is removed. Do not remove or insert the AI Energy Meter ST until you have removed this current transformer terminal. With the special terminal, the process can continue because the current transformer is isolated safely. However, the measuring voltage on the module at the connections UL1-UL3 still needs to be isolated.

Operating principle with CPU/HF interface module

You can remove and insert any number of I/O modules during operation. The CPU/interface module and the inserted I/O modules remain in operation.

NOTICE
Reaction of the CPU when removing and inserting the ET 200SP server module
Please note that the backplane bus is deactivated when you remove the server module, regardless of the CPU operating state. Also note that the outputs do not adopt their configured substitute value behavior when you remove the server module.
This means you should not remove the server module in the CPU operating states STARTUP, RUN and STOP. If you have nevertheless removed the server module, perform a POWER OFF/POWER ON after you have inserted the server module once again.

Operating principle with BusAdapter/CM DP module

It is not permitted to remove or insert the BusAdapter/CM DP module when the supply voltage is switched on. If you remove the BusAdapter/CM DP module unintentionally after startup of the CPU, the supply voltage of the BusAdapter/CM DP module is switched off automatically. To switch on the supply voltage again, you need to perform a POWER OFF/POWER ON after inserting the BusAdapter/CM DP module.

Operating principle with ST, BA interface module

1. You can remove **one** I/O module during operation. If you remove another I/O module, this results in a station stop of the ET 200SP distributed I/O system:
 - All I/O modules of the ET 200SP distributed I/O system fail → substitute value behavior.
 - The interface module continues to exchange data with the IO controller and report diagnostics.

Note

If you want to replace several I/O modules during operation, you must replace them one after the other.

2. If you insert all but one of the I/O modules withdrawn during operation, all I/O modules will start up again.

Note

I/O modules inserted in empty slots and then removed are also regarded as withdrawn during operation.

3. After a POWER OFF/POWER ON of the supply voltage 1L+ of the interface module, all available I/O modules start up again in keeping with the configuration. The evaluation of the I/O modules removed during operation starts again (see 1).

Removing I/O modules

To remove an I/O module, follow these steps:

1. Simultaneously press the top and bottom release buttons of the I/O module.
2. Pull the I/O module out of the BaseUnit, parallel in a forward direction.

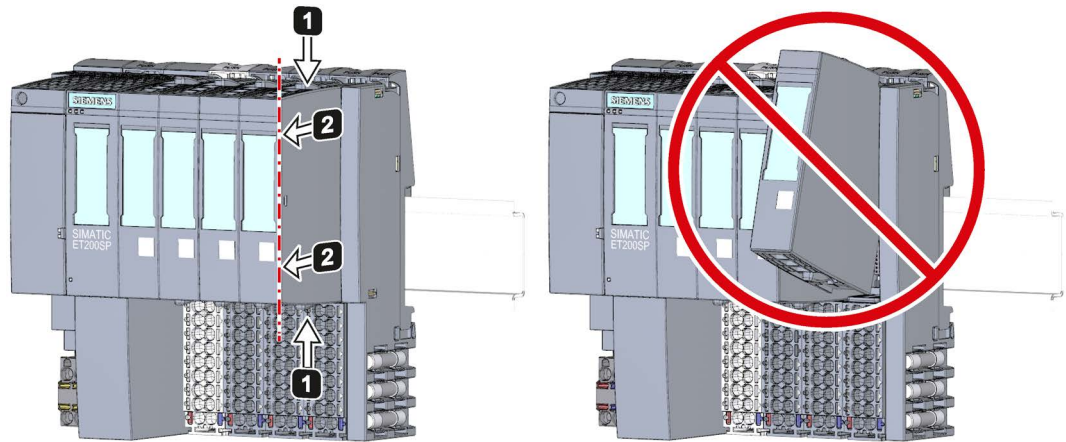


Figure 12-1 Removing I/O modules

See also

Interface modules (<http://support.automation.siemens.com/WW/view/en/55683316/133300>)

12.2 Changing the type of an I/O module

Introduction

The coding element is a two-part element. When shipped from the factory, both parts are in the I/O module. When an I/O module is installed for the first time, a part of the coding element clicks into the BaseUnit. This mechanically prevents the insertion of a different module type.

There are two versions of the ET 200SP distributed I/O system:

- Mechanical coding element: Ensures the mechanical coding described above.
- Electronic coding element: In addition to the above-mentioned mechanical coding, this version also has an electronic, rewritable memory for module-specific configuration data (such as the F-destination address for fail-safe modules, parameter data for IO link master).

Requirement

Refer to section Application planning (Page 26).

NOTICE

Do not manipulate the coding element

Making changes to the coding element may cause dangerous conditions in your plant and/or result in damage to the outputs of the ET 200SP distributed I/O system.

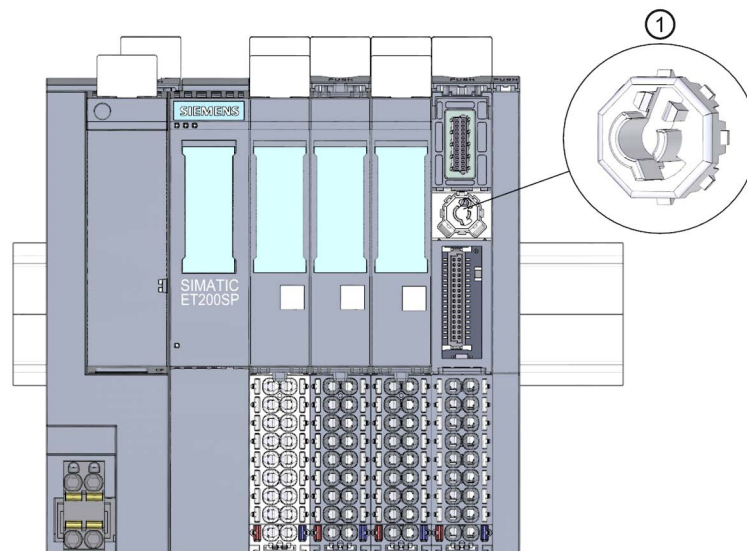
To avoid physical damage, do not manipulate the coding.

Changing the type of an I/O module

You have already removed the I/O module.

To make a type change for an I/O module, follow these steps:

1. Push the coding element out of the BaseUnit using a screwdriver.
2. Put the coding element back onto the removed I/O module.
3. Insert the new I/O module (other module type) into the BaseUnit until you hear it click into place.
4. Label the new I/O module.



① Coding element

Figure 12-2 Changing the type of an I/O module

12.3 Replacing an I/O module

Introduction

When an I/O module is installed for the first time, a part of the coding element clicks into the BaseUnit. When you replace an I/O module with the same type of module, the correct coding element is already present in the BaseUnit.

Requirement

Refer to section Application planning (Page 26).

Replacing an I/O module

You have already removed the I/O module.

To replace an I/O module, follow these steps:

1. Remove the coding element (part) from the underside of the new I/O module.
2. Insert the new I/O module (same module type) into the BaseUnit until you hear it click into place.
3. Mark the new I/O module (labeling strip, equipment labeling plate).

12.4 Replacing the terminal box on the BaseUnit

Introduction

The terminal box is part of the BaseUnit. You can replace the terminal box if necessary. You do not need to dismantle the BaseUnit to do this.

The power and AUX buses of the potential group are not interrupted when you replace the terminal box.

Requirements

- The BaseUnit is mounted, wired and fitted with an I/O module.
- The terminal may only be replaced when the supply voltage is switched off.

Required tools

3 to 3.5 mm screwdriver

Procedure

Watch the video sequence (<http://support.automation.siemens.com/WW/view/en/95886218>)

To replace the terminal box on a BaseUnit, follow these steps:

1. If present, turn off the supply voltage on the BaseUnit.
2. Simultaneously press the top and bottom release buttons of the I/O module and pull the module out of the BaseUnit.
3. Disconnect the wiring on the BaseUnit.
4. The release button of the terminal box is located on the underside of the BaseUnit. Use a screwdriver to push in the small opening at an angle from above.
5. Swivel the screwdriver slightly upwards to loosen the locking mechanism of the terminal box and lever the terminal box up out of the BaseUnit at the same time.
6. Remove the coding element (part) from the terminal box and press it onto the coding element (part) of the I/O module that you removed in the second step.
7. Insert the new terminal box into the BaseUnit at the top and swivel it downwards until it clips into the BaseUnit.
8. Wire up the BaseUnit.

12.4 Replacing the terminal box on the BaseUnit

- 9. Insert the I/O module into the BaseUnit.
- 10. Switch on a supply voltage on the BaseUnit.

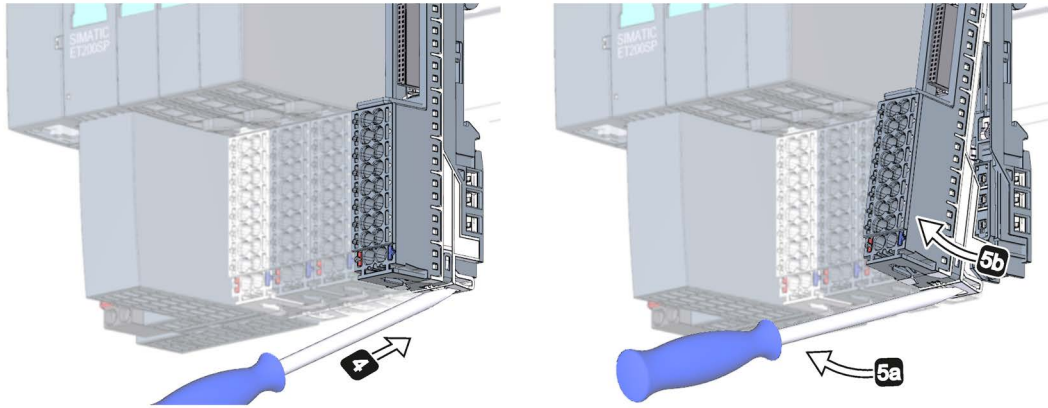


Figure 12-3 Replacing the terminal box on the BaseUnit

12.5 Firmware update

Introduction

During operation it may be necessary to update the firmware (e.g. to extend the available functions).

Update the firmware of the CPU/interface module and the I/O modules using firmware files. The retentive data is retained after the firmware has been updated.

Requirement

- You have downloaded the file(s) for the firmware update from the Product Support (<https://support.industry.siemens.com/cs/ww/en/ps>) web page.

On this web page, select:

- Automation Technology > Automation Systems > Industrial Automation Systems SIMATIC > SIMATIC ET 200 I/O Systems > ET 200 systems for the cabinet > ET 200SP.

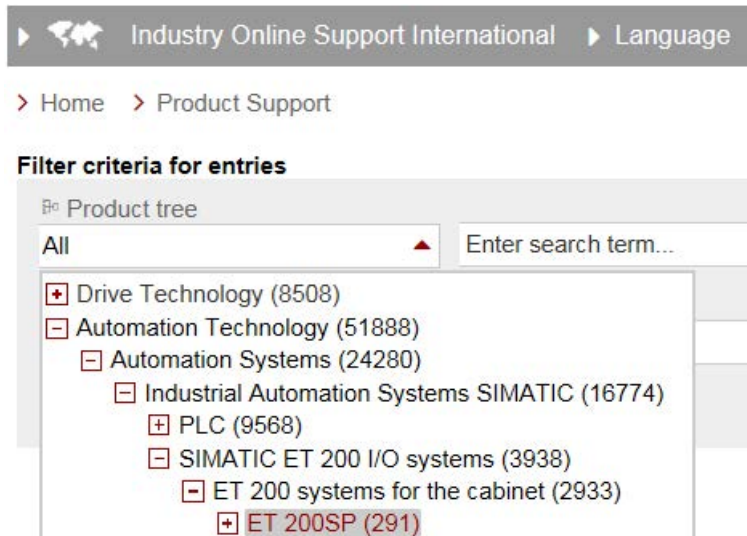


Figure 12-4 ET 200SP in the product tree

From there, navigate to the specific type of module that you want to update. To continue, click on the "Software downloads" link under "Support". Save the desired firmware update files.

All information on ET 200SP

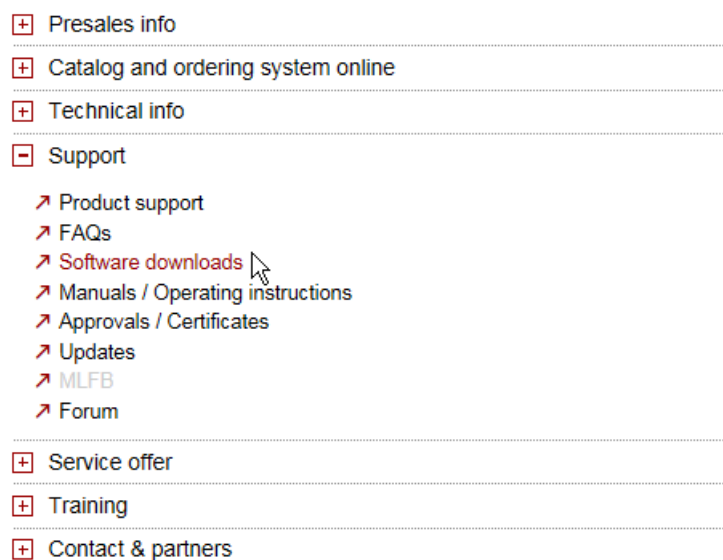


Figure 12-5 Selecting the software downloads

- Before installing the firmware update, make sure that the modules are not being used.

Note

Firmware update of I/O modules

The L+ supply voltage must be present on the module at the start of and during the firmware update.

Additional requirement for fail-safe modules

 **WARNING**

Check the firmware version for fail-safe approval

When using a new firmware version, always check that the version is approved for use in the module in question.

The attachments of the certificate

(<http://support.automation.siemens.com/WW/view/en/49368678/134200>) for SIMATIC Safety specify the firmware version that is approved.

Options for the firmware update

The following options are available for updating firmware:

- Online via PROFINET IO/PROFIBUS DP (with STEP 7)
- Using a SIMATIC memory card (possible for CPU and central I/O modules)
- Via the integrated Web server (possible for CPU as well as central and distributed I/O modules)

Note

Firmware files of the CPU

If you perform a CPU update with STEP 7, you require STEP 7 (TIA Portal as of V13 Update 3).


The table below provides an overview of the media that can be used to update the firmware of a specific module.

Table 12- 2 Overview of firmware update options

Firmware update	CPU	Interface module	I/O module
STEP 7 (TIA Portal) as of V13 Update 3	✓	✓	✓
STEP 7 (TIA Portal)	--	✓	✓
STEP 7 (as of V5.5 SP2)*	--	✓	✓
SIMATIC memory card	✓	--	✓
Web server of the CPU	✓	--	✓

* If the firmware files are only available in this format, you can also install the files using STEP 7 (TIA Portal) but not the SIMATIC memory card or the Web server.

Installation of the firmware update

 WARNING
<p>Risk of impermissible system states</p> <p>The CPU switches to STOP mode or the interface module to "station failure" as a result of the firmware update being installed. STOP or station failure can have an adverse effect on the operation of an online process or a machine.</p> <p>Unexpected operation of a process or a machine can lead to fatal or severe injuries and/or to material damages.</p> <p>Make sure that the CPU/interface module is not executing any active process before installing the firmware update.</p>

Procedure using STEP 7

Proceed as follows to perform an online firmware update with STEP 7:

1. Select the module in the device view.
2. Select the "Online & diagnostics" command from the shortcut menu.
3. Select the "Firmware update" group in the "Functions" folder.
4. Click the "Browse" button to select the path to the firmware update files in the "Firmware update" area.
5. Select the suitable firmware file. The table in the firmware update area lists all modules for which an update is possible with the selected firmware file.
6. Click the "Run update" button. If the module can interpret the selected file, the file is downloaded to the module.

Updating the firmware

The "Run firmware after update" check box is always selected.

When the loading process is complete, the CPU adopts the firmware and then operates with this new firmware.

Note

If a firmware update is interrupted, you need to remove and insert the module before starting the firmware update again.

Procedure using the SIMATIC memory card

Proceed as follows to perform a firmware update via the SIMATIC memory card:

1. Insert a SIMATIC memory card into an SD card reader of your programming device / computer.
2. To store the update file on the SIMATIC memory card, select the SIMATIC memory card in the "Card Reader/USB memory" folder in the project tree.
3. Select the "Card Reader/USB memory > Create firmware update memory card" command in the "Project" menu.
4. Use a file selection dialog to navigate to the firmware update file. In a further step you can decide whether you want to delete the content of the SIMATIC memory card or whether you want to add the firmware update files to the SIMATIC memory card.
5. Insert the SIMATIC memory card with the firmware update files into the CPU.

Point to note when updating firmware for analog modules and the IO-Link Master CM 4xIO-Link communication module

If you want to update firmware for analog modules or the IO-Link Master CM 4xIO-Link communication module, you must supply a load current of 24 V DC to the modules through the infeed element.

Procedure

1. Remove any inserted SIMATIC memory card.
2. Insert the SIMATIC memory card with the firmware update files into the CPU.
3. The firmware update begins shortly after the SIMATIC memory card has been plugged in.
4. Remove the SIMATIC memory card after the firmware update has been completed.
The RUN LED on the CPU lights up yellow, the MAINT LED flashes yellow.

If you then use the SIMATIC memory card as program card, delete the firmware update files manually.

Note

If your hardware configuration contains several modules, the CPU updates all affected modules in the slot sequence, which means in ascending order of the module position in the STEP 7 device configuration.

Procedure using the Web server

The procedure is described in the Web server (<http://support.automation.siemens.com/WW/view/en/59193560>) function manual.

Behavior during the firmware update

Note the following behavior of the relevant I/O module when carrying out a firmware update:

- The DIAG LED display flashes red.
- The I/O module retains its current diagnostic status.
- Diagnostics alarm: Channel temporarily not available (error code 31D)
- All outputs are in a current-free/voltage-free state

Behavior after the firmware update

After the firmware update, check the firmware version of the updated module.

Reference

You can find more information on the procedure in the STEP 7 online help.

12.6 Resetting CPU/interface module (PROFINET) to factory settings

12.6.1 Resetting the CPU to factory settings

Function

The CPU can be reset to its delivery state using "Reset to factory settings". The function deletes all information saved internally on the CPU.

Recommendation:

If you want to remove a PROFINET CPU and use it elsewhere with a different program, or put it into storage, we recommend that you reset the CPU to its factory settings. When restoring factory settings, remember that the IP address parameters are also deleted.

Options for resetting a CPU to factory settings

The following options are available for resetting the CPU to its factory settings:

- Using the mode selector
- Using STEP 7

Procedure using the mode selector

Make sure that there is no SIMATIC memory card in the CPU and that the CPU is in STOP mode (the RUN/STOP LED is lit yellow).

Perform a reset to factory settings when there is no SIMATIC memory card inserted as follows:

1. Set the mode selector to the STOP position.
Result: The RUN/STOP LED lights up yellow.
2. Set the mode selector to the MRES position. Hold the mode selector in this position until the RUN/STOP LED lights up for the 2nd time and remains continuously lit (after three seconds). After this, release the switch.
3. Within the next three seconds, switch the mode selector back to the MRES position, and then back to STOP again.

Result: The CPU executes the "Reset to factory settings", during which time the RUN/STOP LED flashes yellow. When the RUN/STOP LED lights up yellow, the CPU has been reset to factory settings and is in the STOP mode. The "Reset to factory settings" event is entered in the diagnostics buffer.

Procedure using STEP 7

Make sure that an online connection to the CPU exists.

To reset a CPU to factory settings using STEP 7, follow these steps:

1. Open the Online and Diagnostics view of the CPU.
2. In the "Functions" folder, select the "Reset to factory settings" group.
3. If you want to keep the IP address, select the "Retain IP address" option button. If you want to delete the IP address, select the "Reset IP address" option button.
4. Click the "Reset" button.
5. Click "OK" in response to the confirmation prompts.

Result: The CPU executes the "Reset to factory settings", during which time the RUN/STOP LED flashes yellow. When the RUN/STOP LED lights up yellow, the CPU has been reset to factory settings and is in the STOP mode. The "Reset to factory settings" event is entered in the diagnostics buffer.

Result after resetting to factory settings

The following table provides an overview of the contents of the memory objects after the reset to factory settings.

Table 12- 3 Result after resetting to factory settings

Memory object	Content
Actual values of the data blocks, instance data blocks	Initialized
Bit memory, timers and counters	Initialized
Certain retentive tags from technology objects (e.g. adjustment values of absolute encoders)	Initialized
Diagnostics buffer entries (retentive area)	Initialized
Diagnostics buffer entries (non-retentive area)	Initialized
Counter readings of the runtime meters	Initialized
Time of day	Initialized

If a SIMATIC memory card was inserted prior to the factory reset, the CPU downloads the configuration contained on the SIMATIC memory card (hardware and software). A configured IP address then becomes valid again.

Reference

Additional information on the topic "Resetting to factory settings" can be found in the Structure and use of the CPU memory (<http://support.automation.siemens.com/WW/view/en/59193101>) function manual, section on memory areas and retentivity, and in the STEP 7 online help.

12.6.2 Resetting interface module (PROFINET IO) to factory settings

Function

The "Reset to factory settings" function returns the interface module (PROFINET) to its delivery state.

Reset options

- Using STEP 7 (online via PROFINET IO)
- Using a reset button on the interface module (on rear). Exception: The reset button is not available on the IM 155-6 PN BA. See section Resetting the interface module (PROFINET IO) to factory settings with a RESET button (Page 220).

Procedure using STEP 7

To reset an interface module to factory settings using STEP 7, follow these steps:

Make sure that an online connection to the interface module exists.

1. Open the online and diagnostics view of the interface module.
2. In the "Functions" folder, select the "Reset to factory settings" group.
3. Click the "Reset" button.
4. Click "OK" in response to the confirmation prompt.

Result: The interface module then performs a "Reset to factory settings".

Result after resetting to factory settings

The following table shows the values of the interface module properties after a factory reset:

Table 12- 4 Properties of the interface module as shipped

Properties	Value
Parameters	Default setting
IP address	Not available (can be configured when resetting: "Retain IP address"/"Delete IP address")
Device name	Not available
MAC address	Available
I&M data	Identification data (I&M0) available Maintenance data (I&M1, 2, 3, 4) not available
Firmware version	Available

Note

Failure of downstream stations is possible

Downstream stations on a bus segment can fail when the factory settings are restored on an interface module.

Note

Substitute value behavior of the inserted I/O modules on reset to factory settings

The I/O modules of the ET 200SP distributed I/O system do not have the configured status after a reset to factory settings.

Reference

You will find more information on the procedure in the STEP 7 online help.

12.6.3 Resetting the interface module (PROFINET IO) to factory settings with a RESET button

Requirement

The supply voltage to the interface module is turned on.

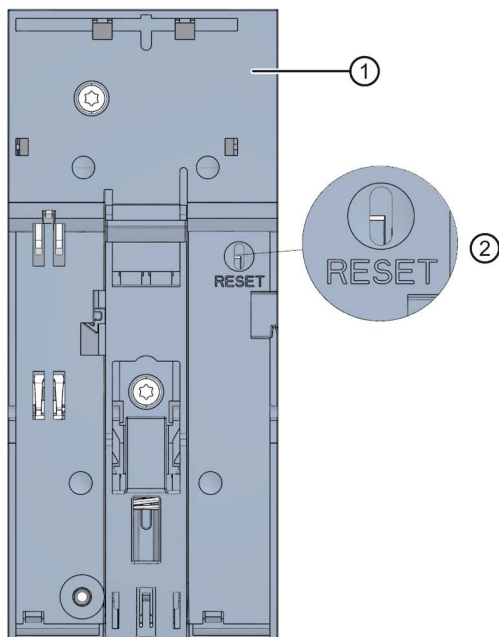
Required tools

3 to 3.5 mm screwdriver (for resetting with a RESET button)

Procedure

To reset an interface module to factory settings using the RESET button, follow these steps:

1. Remove the interface module from the mounting rail (see Mounting the CPU/interface module (Page 42)) and swivel it downwards.
2. The RESET button is located on the rear of the interface module behind a small opening: Press a screwdriver into the small opening for at least 3 seconds to activate the RESET button.
3. Install the interface module back on the mounting rail (see Mounting the CPU/interface module (Page 42)).
4. Check the LED display of the interface module to see whether the reset was successful: RUN LED flashes for 3 seconds, ERROR and MAINT LED are off.
5. Assign parameters to the interface module again.



- ① Rear of the interface module
- ② RESET button

Figure 12-6 RESET button

12.7 Fault reactions with fail-safe modules

Safe state (safety concept)

The basic principle behind the safety concept is the existence of a safe state for all process variables.

Note

For digital F-modules, this safe state is the value "0". This applies to both sensors and actuators.

Fault reactions and startup of the F-system

The safety function means that fail-safe modules use substitute values (safe state) instead of process values (**passivation of the fail-safe module**) in the following situations:

- When the F-system is started up
- If errors are detected during safety-related communication between the F-CPU and the F-module via the PROFIsafe safety protocol (communication error)
- If F-I/O faults or channel faults are detected (e.g., wire break, discrepancy error)

Detected faults are written to the diagnostic buffer of the F-CPU and communicated to the safety program in the F-CPU.

F-modules cannot save errors as retentive data. After a POWER OFF / POWER ON, any faults still existing are detected again during startup. However, you have the option of saving faults in your safety program.

 WARNING
--

For channels that you set to "deactivated" in STEP 7, no diagnostic response or error handling is triggered when a channel fault occurs, not even when such a channel is affected indirectly by a channel group fault ("Channel activated/deactivated" parameter).
--

Remedying faults in the F-system

To remedy faults in your F-system, follow the procedure described in IEC 61508-1:2010 section 7.15.2.4 and IEC 61508-2:2010 section 7.6.2.1 e.

The following steps must be performed:

1. Diagnosing and repairing the fault
2. Revalidation of the safety function
3. Recording in the service report

Substitute value output for fail-safe modules

In the case of F-modules with inputs, if there is passivation, the F-system provides substitute values (0) for the safety program instead of the process data pending at the fail-safe inputs.

In the case of F-modules with outputs, if there is passivation, the F-system transfers substitute values (0) to the fail-safe outputs instead of the output values provided by the safety program. The output channels are de-energized. This also applies when the F-CPU goes into STOP mode. Assignment of substitute values is not possible.

Depending on which F-system you are using and the type of fault that occurred (F-I/O fault, channel fault or communication error), substitute values are used either for the relevant channel only or for all channels of the relevant fail-safe module.

Reintegration of a fail-safe module

The system changes from fail-safe to process values (reintegration of an F-module) either automatically or only after user acknowledgment in the safety program. If channel faults occur, it may be necessary to remove and reinsert the F-module. A detailed listing of faults requiring removal and insertion of the F-module can be found in the section Diagnostic messages of the respective F-module.

After reintegration, the following occurs:

- In the case of an F-module with inputs, the process data pending at the fail-safe inputs is made available to the safety program
- In the case of an F-module with outputs, the output values provided in the safety program are again transferred to the fail-safe outputs

Additional information on passivation and reintegration

For additional information on passivation and reintegration of F-I/O, refer to the SIMATIC Safety, Configuring and Programming (<http://support.automation.siemens.com/WW/view/en/54110126>) manual.

Reaction of the F-module with inputs to communication errors

F-modules with inputs respond differently to communication errors compared to other errors.

If a communication error is detected, the current process values remain set at the inputs of the F-module. There is no passivation of the channels. The current process values are passivated in the F-CPU.

Test functions and eliminating problems

13.1 Test functions

Introduction

You have the option of testing the operation of your user program on the CPU. You can then monitor signal states and values of tags and can assign values to tags to simulate specific situations in the running of the program.

Note

Using test functions

The use of test functions can influence the program execution time and thus the cycle and response times of the controller to a slight extent (a few milliseconds).

Requirements

- There is an online connection to the relevant CPU.
- An executable program is in the CPU.

Test options

- Testing with program status
- Testing with a watch table
- Testing with a force table
- Testing with the LED flash test
- Testing with the trace and logic analyzer function

Testing with program status

The program status allows you to monitor the execution of the program. You can display the values of operands and the results of logic operations (RLO) allowing you to recognize and fix logical errors in your program.

Testing with watch tables

The following functions are available in the watch table:

- Monitoring of tags

Using the watch tables, you can monitor the current values of the individual tags of a user program or a CPU on the programming device or PC.

The following operand areas can be monitored:

- Inputs and outputs (process image) and bit memory
- Contents of data blocks
- Peripheral inputs and peripheral outputs
- Timers and counters

- Modifying tags

Use this function to assign fixed values to the individual tags of a user program or CPU. Modifying is also possible for testing with program status.

The following operand areas are modifiable:

- Inputs and outputs (process image) and bit memory
- Contents of data blocks
- Peripheral inputs and peripheral outputs (for example, %I0.0:P, %Q0.0:P)
- Timers and counters

- "Enable peripheral outputs" and "Modify now"

These two functions enable you to assign fixed values to individual peripheral outputs of a CPU in the STOP mode. You can also use them to check your wiring.

Testing with the force table

The following functions are available in the force table.

- Monitoring of tags

Using the force tables, you can display the current values of the individual tags of a user program or a CPU on the programming device or PC. You can monitor the table with or without a trigger condition.

You can monitor the following tags:

- Bit memory
- Contents of data blocks
- Peripheral inputs (e.g. %I0.0:P)

- Forcing of peripheral inputs and peripheral outputs

You can force individual peripheral inputs or peripheral outputs.

- Peripheral inputs: Forcing of peripheral inputs (for example %I0.0:P) represents the "bypassing" of sensors/inputs by specifying fixed values to the program. Instead of the actual input value (via process image or via direct access) the program receives the force value.
- Peripheral outputs: Forcing of peripheral outputs (for example %Q0.0:P) represents the "bypassing" of the complete program by setting fixed values for the actuators.

Difference between modifying and forcing

The fundamental difference between the modifying and forcing functions consists in the storage behavior:

- Modifying: Modifying of tags is an online function and is not stored in the CPU. You can end modifying of tags in the watch table or by disconnecting the online connection.
- Forcing: A force job is written to the SIMATIC memory card and is retained after a POWER OFF. You can only end the forcing of peripheral inputs and peripheral outputs in the force table.

Testing with the LED flash test

In many online dialogs, you can perform an LED flash test. This function is useful, for example, when you are not sure which device in the hardware configuration corresponds to the device currently selected in the software.

When you click the "Flash LED" button, an LED flashes on the currently selected device. On the CPU, the following LEDs flash: RUN/STOP LED, ERROR LED and MAINT LED. The LEDs continue to flash until you terminate the flash test.

Testing with the trace and logic analyzer function

The trace function is used to record the CPU tags, depending on the settable trigger conditions. Tags are, for example, the drive parameters or system and user tags of a CPU. The CPU saves the recordings. You can display and evaluate the recordings with STEP 7, if necessary.

The trace function can be called from the CPU's folder in the project tree, under the name "Traces".

Simulation

With STEP 7 you can run and test the hardware and software of the project in a simulated environment. Start the simulation using the menu command "Online" > "Simulation" > "Start".

Reference

You can find more information on test functions in the STEP 7 online help.

Further information about testing with trace and logic analyzer functions is available in the Function Manual Using the trace and logic analyzer function (<http://support.automation.siemens.com/WW/view/en/64897128>).

13.2 Reading out/saving service data

Introduction

In addition to the contents of the diagnostics buffer, the service data contains a wide range of extra information about the internal status of the CPU. If a problem occurs the CPU that cannot be solved with other methods, send the service data to our Service & Support team. The service data allows Service & Support to run fast analysis of the problems that have occurred.

Requirement

You can read service data with:

- the Web server
- STEP 7
- SIMATIC memory card

Procedure using the Web server

To read service data using the Web server, follow these steps:

1. Open a Web browser that is suitable for communication with the CPU.
2. Enter the following address in the address bar of the Web browser:
https://<CPU IP address>/save_service_data.html, e.g.
https://172.23.15.3/save_service_data.html
3. The service data page will appear on your screen, with a button for saving the service data.



Figure 13-1 Reading out service data with the Web server

4. Save the service data locally on your PC/programming device, by clicking "Save ServiceData".

Result: The CPU saves the data to a .dmp file with the following naming convention: "<Article number> <serial number> <time stamp>.dmp". The file name cannot be changed.

Procedure using STEP 7

A description of how to save service data is available under the keyword "Save service data" in STEP 7 online help.

Procedure using the SIMATIC memory card

Use the SIMATIC memory card to read out the service data only if you are no longer able to communicate with the CPU via Ethernet. In all other cases it is preferable to read out the service data via the Web server or STEP 7.

To read service data using the SIMATIC memory card, follow these steps:

1. Insert the SIMATIC memory card into the card reader of your PC / programming device.
2. Open the job file S7_JOB.S7S in an editor.
3. Overwrite the entry PROGRAM with the string DUMP in the editor.
Do not use any spaces/line breaks/quotation marks to ensure that the file size is exactly 4 bytes.
4. Save the file under the existing file name.
5. Make sure that the SIMATIC memory card is not write-protected and insert it in the card slot of the CPU.

Result: The CPU writes the service data file DUMP.S7S to the SIMATIC memory card and remains in STOP mode.

The transfer of the service data has been completed as soon as the STOP LED stops flashing and lights up continuously. If the transfer was successful, only the STOP LED lights up. If the transfer was not successful, the STOP LED lights up and the ERROR LED flashes. In case of an error, the CPU stores a text file with a note on the error that occurred in the DUMP.S7S folder.

Technical specifications

Introduction

This chapter lists the technical specifications of the system:

- The standards and test values that the ET 200SP distributed I/O system complies with and fulfills.
- The test criteria according to which the ET 200SP distributed I/O system was tested.

Technical specifications for the modules

The technical specifications of the individual modules can be found in the manuals of the modules themselves. In the event of deviations between the statements in this document and the manuals, the statements in the manuals take priority.

14.1 Standards and approvals

Currently valid markings and approvals

Note

Information on the components of the ET 200SP

The currently valid markings and approvals are printed on the components of the ET 200SP distributed I/O system.

Safety information

 **WARNING**

Personal injury and damage to property may occur

In hazardous areas, personal injury and damage to property may occur if you disconnect plug-in connections during operation of an ET 200SP distributed I/O system.

Always switch off the power to the ET 200SP distributed I/O system when disconnecting plug-in connections in hazardous areas.

 **WARNING**

Explosion hazard

If you replace components, compliance with Class I, DIV 2 can become invalid.

 **WARNING**

Area of application

This device is only suitable for use in Class I, Div. 2, Group A, B, C, D, or in non-hazardous areas.

CE marking



The ET 200SP distributed I/O system meets the requirements and protection targets of the following EC directives and complies with the harmonized European standards (EN) for programmable logic controllers published in the official gazettes of the European Community:

- 2006/95/EC "Electrical equipment designed for use within certain voltage limits" (Low-Voltage Directive)
- 2004/108/EC "Electromagnetic Compatibility" (EMC Directive)
- 94/9/EC "Equipment and protective systems intended for use in potentially explosive atmospheres" (Explosion Protection Directive)
- For ET 200SP fail-safe modules, the following also applies: 2006/42/EC "Machinery Directive"

The EC declarations of conformity are available for the responsible authorities at:

Siemens AG
Digital Factory

Factory Automation
DF FA AS DH AMB
Postfach 1963
D-92209 Amberg

These are also available for download on the Customer Support Internet pages, keyword "Declaration of Conformity".

cULus approval



Underwriters Laboratories Inc., complying with

- UL 508 (Industrial Control Equipment)
- CSA C22.2 No. 142 (Process Control Equipment)

OR

cULus HAZ. LOC. approval



Underwriters Laboratories Inc., complying with

- UL 508 (Industrial Control Equipment)
- CSA C22.2 No. 142 (Process Control Equipment)
- ANSI/ISA 12.12.01
- CSA C22.2 No. 213 (Hazardous Location)

APPROVED for use in
Class I, Division 2, Group A, B, C, D Tx;
Class I, Zone 2, Group IIC Tx

Installation Instructions for cULus haz.loc.

- WARNING - Explosion Hazard - Do not disconnect while circuit is live unless area is known to be non-hazardous.
- WARNING - Explosion Hazard - Substitution of components may impair suitability for Class I, Division 2 or Zone 2.
- This equipment is suitable for use in Class I, Division 2, Groups A, B, C, D; Class I, Zone 2, Group IIC; or non-hazardous locations.

WARNING: EXPOSURE TO SOME CHEMICALS MAY DEGRADE THE SEALING PROPERTIES OF MATERIALS USED IN THE RELAYS.

FM approval



Factory Mutual Research (FM) according to
Approval Standard Class Number 3611, 3600, 3810 (ANSI/ISA 82.02.01)
CSA C22.2 No. 213
CSA C22.2 No. 1010-1

APPROVED for use in Class I, Division 2, Group A, B, C, D Tx;
Class I, Zone 2, Group IIC Tx

ATEX approval



According to EN 60079-15 (Electrical apparatus for potentially explosive atmospheres; Type of protection "n") and EN 60079-0 (Electrical apparatus for potentially explosive gas atmospheres - Part 0: General Requirements)



II 3 G Ex nA IIC Tx Gc
DEKRA 12ATEX0038X

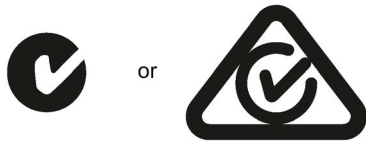
IECEX approval



According to IEC 60079-15 (Explosive atmospheres - Part 15: Equipment protection by type of protection "n") and IEC 60079-0 (Explosive atmospheres - Part 0: Equipment - General requirements)



Marking for Australia and New Zealand



The ET 200SP distributed I/O system meets the requirements of the standard AS/NZS CISPR 16.

Korea Certificate KCC-REM-S49-ET200SP



Note that this device corresponds to limit class A in terms of the emission of radio frequency interference. This device can be used in all areas, except residential areas.

이 기기는 업무용(A급) 전자파 적합기기로서 판매자 또는 사용자는 이 점을 주의하시기
바라며 가정 외의 지역에서 사용하는 것을 목적으로 합니다.

Marking for the Eurasian Customs Union



EAC (Eurasian Conformity)

Customs Union of Russia, Belarus and Kazakhstan

Declaration of conformity with the technical requirements of the Customs Union (TR CU).

IEC 61131

The ET 200SP distributed I/O system meets the requirements and criteria of the standard IEC 61131-2 (Programmable logic controllers, part 2: Equipment requirements and tests).

PROFINET standard

The ET 200SP distributed I/O system is based on IEC 61158 Type 10.

PROFIBUS standard

The ET 200SP distributed I/O system is based on IEC 61158 Type 3.

IO-Link standard

The ET 200SP distributed I/O system is based on IEC 61131-9.

Shipbuilding approval

Classification societies:

- ABS (American Bureau of Shipping)
- BV (Bureau Veritas)
- DNV (Det Norske Veritas)
- GL (Germanischer Lloyd)
- LRS (Lloyds Register of Shipping)
- Class NK (Nippon Kaiji Kyokai)

Use in industrial environments

SIMATIC products are designed for use in industry.

Table 14- 1 Use in industrial environments

Area of applica- tion	Interference emission requirements	Interference immunity requirements
Industry	EN 61000-6-4:2011	EN 61000-6-2:2005

Use in residential areas

Note

The ET 200SP is intended for use in industrial areas; use in residential areas may have an impact on radio/TV reception.

If you want to use the ET 200SP distributed I/O system in residential areas, you must ensure that its radio frequency interference emission complies with limit class B in accordance with EN 55011.

Suitable measures for achieving RF interference level Class B include, for example:

- Installation of the ET 200SP distributed I/O system in grounded control cabinets/control boxes
- Use of filters in the supply lines

Reference

The certificates for the markings and approvals can be found on the Internet under Service&Support (<http://www.siemens.com/automation/service&support>).

14.2 Electromagnetic compatibility

Definition

Electromagnetic compatibility (EMC) is the ability of an electrical installation to function satisfactorily in its electromagnetic environment without interfering with that environment.

Among other things, the ET 200SP distributed I/O system also meets the requirements of the EMC legislation for the European single market. The prerequisite is that the ET 200SP distributed I/O system complies with the requirements and guidelines relating to electrical equipment.

EMC in accordance with NE21

The ET 200SP distributed I/O system meets the EMC specifications of the NAMUR recommendation NE21.

Pulse-shaped disturbance variables

The table below shows the electromagnetic compatibility of the ET 200SP distributed I/O system with regard to pulse-shaped disturbance variables.

Table 14- 2 Pulse-shaped disturbance variables

Pulse-shaped disturbance variable	Tested with	Corresponds to degree of severity
Electrostatic discharge in accordance with IEC 61000-4-2	Air discharge: ± 8 kV	3
	Contact discharge: ± 6 kV	3
Burst pulses (fast transients) in accordance with IEC 61000-4-4	± 2 kV (power supply line)	3
	± 2 kV (signal line >30 m)	3
	± 1 kV (signal line <30 m)	
High-energy single pulse (surge) in accordance with IEC 61000-4-5 External protective circuit required (see Function manual Designing interference-free controllers (http://support.automation.siemens.com/WW/view/en/59193566))		3
• Asymmetric coupling	± 2 kV (power supply lines) DC with protective elements ± 2 kV (signal lines/data lines only >30 m) with protective elements if necessary	
• Symmetric coupling	± 1 kV (power supply line) DC with protective elements ± 1 kV (signal line/data line only >30 m) with protective elements if necessary	

Sinusoidal disturbance variables

The tables below show the electromagnetic compatibility of the ET 200SP distributed I/O system with regard to sinusoidal disturbance variables.

- RF radiation

Table 14- 3 Sinusoidal disturbance variables with RF radiation

RF radiation according to IEC 61000-4-3/NAMUR 21 Electromagnetic RF field, amplitude-modulated		Corresponds to degree of severity
80 to 1000 MHz; 1.0 to 2.0 GHz	2.0 GHz to 2.7 GHz	3
10 V/m	3 V/m	
80% AM (1 kHz)		

- RF coupling

Table 14- 4 Sinusoidal disturbance variables with RF coupling

RF coupling in accordance with IEC 61000-4-6	Corresponds to degree of severity
(10 kHz) 150 kHz to 80 MHz	3
10 V _{rms} unmodulated	
80% AM (1 kHz)	
150 Ω source impedance	

Emission of radio frequency interference

Interference emission of electromagnetic fields in accordance with EN 55016: Limit class A, group 1 (measured at a distance of 10 m).

Table 14- 5 Interference emission of electromagnetic fields in accordance with EN 55016

Frequency	Interference emission
30 MHz to 230 MHz	< 40 dB (μV/m) QP
230 MHz to 1000 MHz	< 47 dB (μV/m) QP

Interference emission via the AC power supply in accordance with EN 55016: Limit class A, Group 1.

Table 14- 6 Interference emission via the AC power supply in accordance with EN 55016

Frequency	Interference emission
0.15 MHz to 0.5 MHz	< 79 dB (μV/m)Q
	< 66 dB (μV/m) M
0.5 MHz to 30 MHz	< 73 dB (μV/m)Q
	< 60 dB (μV/m) M

14.3 Electromagnetic compatibility of fail-safe modules

Protecting ET 200SP with fail-safe modules against overvoltages

If your equipment requires protection from overvoltage, we recommend that you use an external protective circuit (surge filter) between the load voltage power supply and the load voltage input of the BaseUnits to ensure surge immunity for the ET 200SP with fail-safe modules.

Note

Lightning protection measures always require a case-by-case examination of the entire plant. Almost complete protection from overvoltages, however, can only be achieved if the entire building surroundings have been designed for overvoltage protection. In particular, this involves structural measures in the building design phase.

For detailed information regarding overvoltage protection, we recommend that you contact your Siemens representative or a company specializing in lightning protection.

14.3 Electromagnetic compatibility of fail-safe modules

The following figure shows an example configuration with fail-safe modules. Voltage is supplied by 1 power supply unit. Note, however, that the total current of the modules fed by the power supply unit must not exceed the permissible limits. You can also use multiple power supply units.

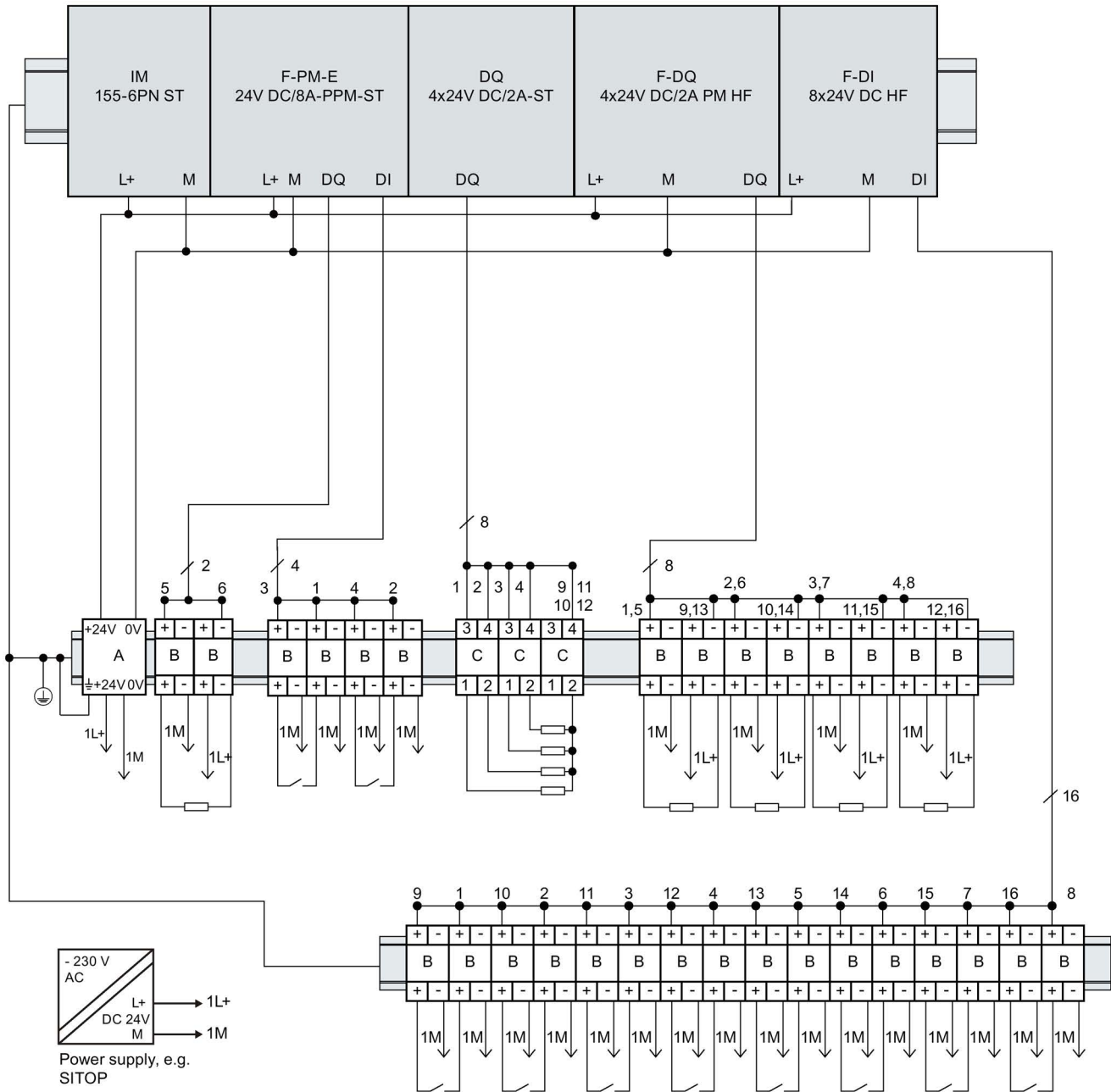


Figure 14-1 External protective circuit (surge filter) for ET 200SP with fail-safe modules

Name	Part number of Dehn Co.
A = BVT AD 24	918 402
B = DCO RK D 5 24	919 986
C = DEHNconnect DCO RK E 60	919 990

14.4 Shipping and storage conditions

Introduction

The ET 200SP distributed I/O system exceeds requirements in terms of shipping and storage conditions according to IEC 61131-2. The following information applies to modules that are shipped and/or stored in their original packaging.

Table 14- 7 Shipping and storage conditions for modules

Type of condition	Permissible range
Free fall (in shipping package)	≤1 m
Temperature	From -40 °C to +70 °C
Barometric pressure	1080 hPa to 660 hPa (corresponds with an altitude of -1000 m to 3500 m)
Relative humidity	5% to 95%, without condensation
Sinusoidal oscillations according to IEC 60068-2-6	5 - 8.4 Hz: 3.5 mm 8.4 - 500 Hz: 9.8 m/s ²
Impact according to IEC 60068-2-27	250 m/s ² , 6 ms, 1000 shocks

14.5 Mechanical and climatic environmental conditions

Operating conditions

The ET 200SP distributed I/O system is suitable for use in weather-proof, fixed locations. The operating conditions exceed requirements according to DIN IEC 60721-3-3:

- Class 3M3 (mechanical requirements)
- Class 3K3 (climatic requirements)

Mechanical environmental conditions

The following table shows the mechanical environmental conditions in the form of sinusoidal vibrations.

Table 14- 8 Mechanical environmental conditions

Frequency band	ET 200SP with BusAdapters BA 2×FC, BA 2×SCRJ, BA SCRJ/FC, BA 2×LC and BA LC/FC	ET 200SP with BusAdapters BA 2×RJ45, BA SCRJ/RJ45 and BA LC/RJ45	ET 200SP with IM 155-6 PN BA	ET 200SP with digital output module F-RQ 1x24VDC/24..230VAC/5 A
5 ≤ f ≤ 8.4 Hz	3.5 mm amplitude			
8.4 ≤ f ≤ 150 Hz	1 g constant acceleration			
10 ≤ f ≤ 60 Hz	0.35 mm amplitude	---	---	---
60 ≤ f ≤ 1000 Hz	5 g constant acceleration			

Tests of mechanical environmental conditions

The following table provides important information with respect to the type and scope of the tests of environmental mechanical conditions.

Table 14- 9 Tests of mechanical environmental conditions

Condition tested	Test standard	Comment
Vibration	Vibration test according to IEC 60068-2-6 (sinusoidal)	Type of vibration: Frequency sweeps with a rate of change of 1 octave/minute. BA 2×RJ45, BA SCRJ/RJ45, BA LC/RJ45, IM 155-6 PN BA, digital output module F-RQ 1x24VDC/24..230VAC/5A <ul style="list-style-type: none"> 5 Hz ≤ f ≤ 8.4 Hz, 3.5 mm constant amplitude 8.4 Hz ≤ f ≤ 150 Hz, 1 g constant acceleration BA 2×FC, BA 2×SCRJ, BA SCRJ/FC, BA 2×LC, BA LC/FC <ul style="list-style-type: none"> 10 Hz ≤ f ≤ 60 Hz, 0.35 mm constant amplitude 60 Hz ≤ f ≤ 1000 Hz, 5 g constant acceleration Duration of vibration: 10 frequency sweeps per axis at each of three vertically aligned axes
Shock	Shock, tested according to IEC 60068-2-27	Type of shock: Half-sine Shock intensity: 150 m/s ² peak value, 11 ms duration Direction of shock: 3 shocks in each direction (+/-) at each of three vertically aligned axes
Continuous shock ¹	Shock, tested according to IEC 60068-2-27	Type of shock: Half-sine Shock intensity: 25 g peak value, 6 ms duration Direction of shock: 1000 shocks in each direction (+/-) at each of three vertically aligned axes

¹ Does not apply to digital output module F-RQ 1x24VDC/24..230VAC/5A

14.6 Information on insulation, protection class, degree of protection and rated voltage

Climatic environmental conditions

The table below shows the permissible climatic environmental conditions for the ET 200SP distributed I/O system:

Table 14- 10 Climatic environmental conditions

Environmental conditions	Permissible range	Comments
Temperature: horiz. mounting position: vertical mounting position:	0 to 60 °C 0 to 50 °C	-
Permitted temperature change	10 K/h	-
Relative humidity	from 10 to 95%	Without condensation, corresponds to relative humidity (RH) stress grade 2 in accordance with IEC 61131 part 2
Barometric pressure	1080 hPa to 795 hPa	Corresponds to an altitude of -1000 to 2000 m
Concentration of pollutants	SO ₂ : <0.5 ppm; RH <60%, no condensation H ₂ S: <0.1 ppm; RH <60%, no condensation	-
	ISA-S71.04 severity level G1; G2; G3	-

14.6 Information on insulation, protection class, degree of protection and rated voltage

Insulation

The insulation is designed in accordance with the requirements of EN 61131-2:2007.

Pollution degree/overvoltage category according to IEC 61131

- Pollution degree 2
- Overvoltage category: II

Protection class according to IEC 61131-2:2007

The ET 200SP distributed I/O system meets protection class I and includes parts of protection classes II and III.

The grounding of the mounting rail must meet the requirements for a functional earth FE.

Recommendation: For a configuration immune to interference, the line for the ground should have a cross-section > 6 mm².

The installation location (e.g. enclosure, control cabinet) must have a protective conductor connection that meets the standard to maintain protection class I.

14.7 Use of the ET 200SP in zone 2 potentially explosive atmospheres

Degree of protection IP20

Degree of protection IP20 in accordance with IEC 60529 for all modules of the ET 200SP distributed I/O system, which means:

- Protection against contact with standard probes
- Protection against foreign objects with diameters in excess of 12.5 mm
- No protection against water

Rated voltage for operation

The ET 200SP distributed I/O system works with the rated voltage and corresponding tolerances listed in the following table.

Note the supply voltage of each module when selecting the rated voltage.

Table 14- 11 Rated voltage for operation

Rated voltage	Tolerance range
24 V DC	19.2 to 28.8 V DC ¹
	18.5 to 30.2 V DC ²
120 V AC	93 to 132 V AC
230 V AC	187 to 264 V AC

¹ Static value: Creation as functional extra-low voltage with safe electrical isolation according to IEC 60364-4-41

² Dynamic value: Including ripple, e.g. as in the case of three-phase bridge power rectification

14.7 Use of the ET 200SP in zone 2 potentially explosive atmospheres

See product information "Use of subassemblies/modules in Zone 2 Hazardous Area" (<http://support.automation.siemens.com/WW/view/en/19692172>).

Dimension drawings

A.1 Shield connector

Dimensional diagram of the shield connector

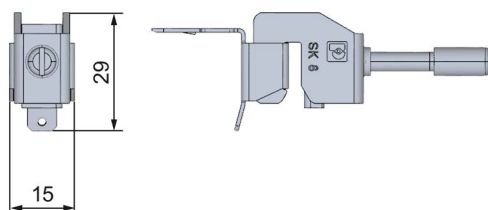


Figure A-1 Dimensional diagram of the shield connector

A.2 Labeling strip

Dimensional diagram of labeling strips and roll

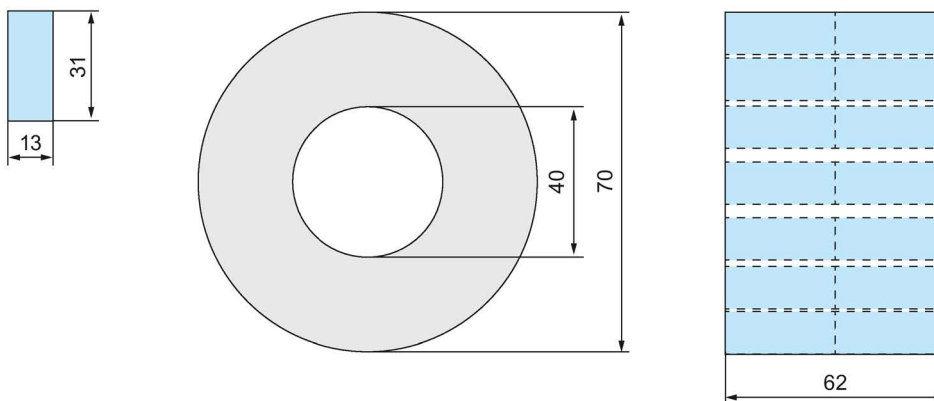


Figure A-2 Dimensional diagram of labeling strips and roll

A.3 Reference identification labels

Dimensional diagram of reference identification label and sheet

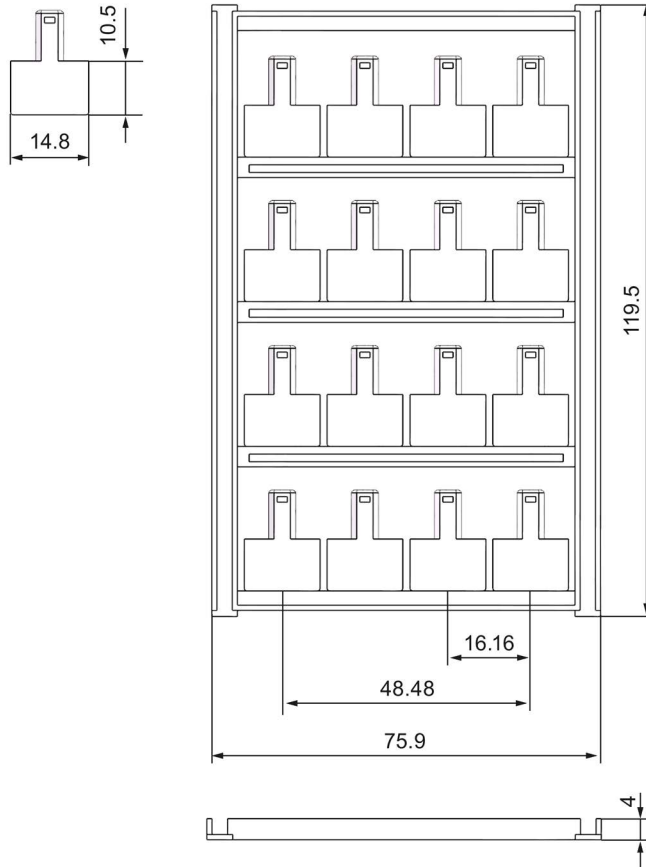


Figure A-3 Dimensional diagram of reference identification label and sheet

Accessories/spare parts

Accessories for the ET 200SP distributed I/O system

Table B- 1 Accessories, general

Accessories, general	Packing unit	Article number
BusAdapter		
<ul style="list-style-type: none"> BA 2×RJ45 (PROFINET BusAdapter with standard Ethernet socket) 	1 unit	6ES7193-6AR00-0AA0
<ul style="list-style-type: none"> BA 2×FC (PROFINET BusAdapter with FastConnect Ethernet connection) 	1 unit	6ES7193-6AF00-0AA0
<ul style="list-style-type: none"> BA 2×SCRJ (PROFINET BusAdapter with POF/PCF fiber-optic cable connection) 	1 unit	6ES7193-6AP00-0AA0
<ul style="list-style-type: none"> BA SCRJ/RJ45 (media converter, PROFINET BusAdapter with POF/PCF fiber-optic cable ⇔ standard RJ45 connector) 	1 unit	6ES7193-6AP20-0AA0
<ul style="list-style-type: none"> BA SCRJ/FC (media converter, PROFINET BusAdapter with POF/PCF fiber-optic cable ⇔ direct connection of bus cable) 	1 unit	6ES7193-6AP40-0AA0
<ul style="list-style-type: none"> BA 2xLC (PROFINET BusAdapter with glass fiber-optic cable connection) 	1 unit	6ES7193-6AG00-0AA0
<ul style="list-style-type: none"> BA LC/RJ45 (media converter, PROFINET BusAdapter with glass fiber-optic cable ⇔ standard RJ45 connector) 	1 unit	6ES7193-6AG20-0AA0
<ul style="list-style-type: none"> BA LC/FC (media converter, PROFINET BusAdapter with glass fiber-optic cable ⇔ direct connection of bus cable) 	1 unit	6ES7193-6AG40-0AA0
<ul style="list-style-type: none"> BA-Send 1xFC (for the station expansion via ET-Connection, mixed configuration ET 200SP/ET 200AL) 	1 unit	6ES7193-6AS00-0AA0
Cover for the BusAdapter interface	5 units	6ES7591-3AA00-0AA0
PROFIBUS FastConnect bus connector	1 unit	6ES7972-0BB70-0XA0
Server module (spare part)	1 unit	6ES7193-6PA00-0AA0
BU cover		
<ul style="list-style-type: none"> 15 mm wide 	5 units	6ES7133-6CV15-1AM0
<ul style="list-style-type: none"> 20 mm wide 	5 units	6ES7133-6CV20-1AM0
24 V DC connector	10 units	6ES7193-4JB00-0AA0
Shield connection for BaseUnit (shield contacts and shield terminals)	5 units	6ES7193-6SC00-1AM0

Accessories, general	Packing unit	Article number
Reference identification label, sheet with 16 labels	10 units	6ES7193-6LF30-0AW0
Labeling strips (for labeling the I/O modules)		
• Roll, light gray (with a total of 500 labeling strips)	1 unit	6ES7193-6LR10-0AA0
• Roll, yellow (with a total of 500 labeling strips)	1 unit	6ES7193-6LR10-0AG0
• DIN A4 sheets, light gray (with a total of 1000 labeling strips)	10 units	6ES7193-6LA10-0AA0
• DIN A4 sheets, yellow (with a total of 1000 labeling strips)	10 units	6ES7193-6LA10-0AG0
Electronic coding element (type H)	5 units	6ES7193-6EH00-1AA0
Mounting rails, tinned steel strip		
• Length: 483 mm	1 unit	6ES5710-8MA11
• Length: 530 mm	1 unit	6ES5710-8MA21
• Length: 830 mm	1 unit	6ES5710-8MA31
• Length: 2000 mm	1 unit	6ES5710-8MA41

Table B- 2 Accessories, color identification labels (push-in terminals), 15 mm wide

Accessories, color identification labels (push-in terminals), 15 mm wide	Packing unit	Article number
16 process terminals (see I/O module manual)		
• Gray (terminals 1 to 16); color code CC00	10 units	6ES7193-6CP00-2MA0
• Gray (terminals 1 to 8), red (terminals 9 to 16); color code CC01	10 units	6ES7193-6CP01-2MA0
• Gray (terminals 1 to 8), blue (terminals 9 to 16); color code CC02	10 units	6ES7193-6CP02-2MA0
• Gray (terminals 1 to 8), red (terminals 9 to 12), gray (terminals 13 to 16); color code CC03	10 units	6ES7193-6CP03-2MA0
• Gray (terminals 1 to 8), red (terminals 9 to 12), blue (terminals 13 to 16); color code CC04	10 units	6ES7193-6CP04-2MA0
• Gray (terminals 1 to 12), red (terminals 13 and 14), blue (terminals 15 and 16)	10 units	6ES7193-6CP05-2MA0
10 AUX terminals (for BU15-P16+A10+2D, BU15-P16+A10+2B)		
• Yellow-green (terminals 1A to 10A); color code CC71	10 units	6ES7193-6CP71-2AA0
• Red (terminals 1A to 10A); color code CC72	10 units	6ES7193-6CP72-2AA0
• Blue (terminals 1A to 10A); color code CC73	10 units	6ES7193-6CP73-2AA0
10 add-on terminals (for BU15-P16+A0+12D/T, BU15-P16+A0+12B/T)		
• Red (terminals 1B to 5B), blue (terminals 1 to 5C); color code CC74	10 units	6ES7193-6CP74-2AA0

Table B- 3 Accessories, color identification labels (push-in terminals), 20 mm wide

Accessories, color identification labels (push-in terminals), 20 mm wide	Packing unit	Article number
12 process terminals (see I/O module manual)		
<ul style="list-style-type: none"> Gray (terminals 1 to 4), red (terminals 5 to 8), blue (terminals 9 to 12); color code CC41 	10 units	6ES7193-6CP41-2MB0
<ul style="list-style-type: none"> Gray (terminals 1 to 8), red (terminals 9 and 10), blue (terminals 11 and 12), color code CC42 	10 units	6ES7193-6CP42-2MB0
6 process terminals (see I/O module manual)		
<ul style="list-style-type: none"> Gray (terminals 1 to 4), red (terminal 5), blue (terminal 6); color code CC51 	10 units	6ES7193-6CP51-2MC0
<ul style="list-style-type: none"> Gray (terminals 1, 2 and 5), red (terminals 3 and 4), blue (terminal 6); color code CC52 	10 units	6ES7193-6CP52-2MC0
4 AUX terminals (for BU20-P12+A4+0B)		
<ul style="list-style-type: none"> Yellow-green (terminals 1A to 4A); color code CC81 	10 units	6ES7193-6CP81-2AB0
<ul style="list-style-type: none"> Red (terminals 1A to 4A); color code CC82 	10 units	6ES7193-6CP82-2AB0
<ul style="list-style-type: none"> Blue (terminals 1A to 4A); color code CC83 	10 units	6ES7193-6CP83-2AB0
2 AUX terminals (for BU20-P6+A2+4D, BU20-P6+A2+4B)		
<ul style="list-style-type: none"> Yellow-green (terminals 1A and 2A); color code CC84 	10 units	6ES7193-6CP84-2AC0
<ul style="list-style-type: none"> Red (terminals 1A and 2A); color code CC85 	10 units	6ES7193-6CP85-2AC0
<ul style="list-style-type: none"> Blue (terminals 1A and 2A); color code CC86 	10 units	6ES7193-6CP86-2AC0

Table B- 4 SIMATIC memory card accessories

Capacity	Packing unit	Article number
4 MB	1 unit	6ES7954-8LCxx-0AA0
12 MB	1 unit	6ES7954-8LExx-0AA0
24 MB	1 unit	6ES7954-8LFxx-0AA0
256 MB	1 unit	6ES7954-8LL02-0AA0
2 GB	1 unit	6ES7954-8LPxx-0AA0
32 GB	1 unit	6ES7954-8LT02-0AA0

Components for lightning protection (lightning protection zone transition 0_B to 1, 1 to 2 and 2 to 3)

You must install overvoltage protection devices in the ET 200SP distributed I/O system for lightning protection purposes. You can find more information in the Designing interference-free controllers (<http://support.automation.siemens.com/WW/view/en/59193566>) function manual.

Online catalog

Additional article numbers for ET 200SP can be found on the Internet (<http://mall.industry.siemens.com>) in the online catalog and online ordering system.

B.1 Lightning protection and overvoltage protection for fail-safe modules

Overvoltage arrestors for fail-safe modules

Note

This section only lists the overvoltage arrestors that may be used to protect the fail-safe modules.

Be sure to observe the detailed information on lightning protection and overvoltage protection of the ET 200SP distributed I/O system in Electromagnetic compatibility of fail-safe modules (Page 237).

Components for overvoltage protection of fail-safe modules (lightning protection zone transition 0_B to 1)

The overvoltage arrestors are only required for unshielded cables. The Configuring interference-free controllers (<http://support.automation.siemens.com/WW/view/en/59193566>) Function Manual lists the overvoltage arrestors which you may use for fail-safe modules.

Calculating the leakage resistance

Introduction

If you wish to protect the ET 200SP using a ground-fault detector or a residual current circuit breaker, then you need the leakage resistance to select the correct safety components.

Ohmic resistance

When determining the leakage resistance of the ET 200SP, you must take into account the ohmic resistance from the RC combination of the module in question:

Table C- 1 Ohmic resistance

Module	Ohmic resistance from RC network
CPU/interface module	10 MΩ (±5 %)
BaseUnit BU15...D	10 MΩ (±5 %)

Formula

You can calculate the leakage resistance of the ET 200SP using the following formula if you protect all of the modules listed above with one ground-fault detector:

$$R_{ET200SP} = R_{module} / N$$

$R_{ET200SP}$ = Leakage resistance of the ET 200SP
 R_{module} = Leakage resistance of a module
 N = Number of BaseUnits BU15...D and interface module in the ET 200SP

$$R_{CPU/IM} = R_{BU15...D} = R_{Module} = 9.5 \text{ M}\Omega$$

$R_{CPU/IM}$ = Leakage resistance of CP/interface module
 $R_{BU15...D}$ = Leakage resistance of the BaseUnit BU15...D

If you protect the modules listed above within an ET 200SP with several ground-fault detectors, you must determine the leakage resistance for each individual ground-fault detector.

Example

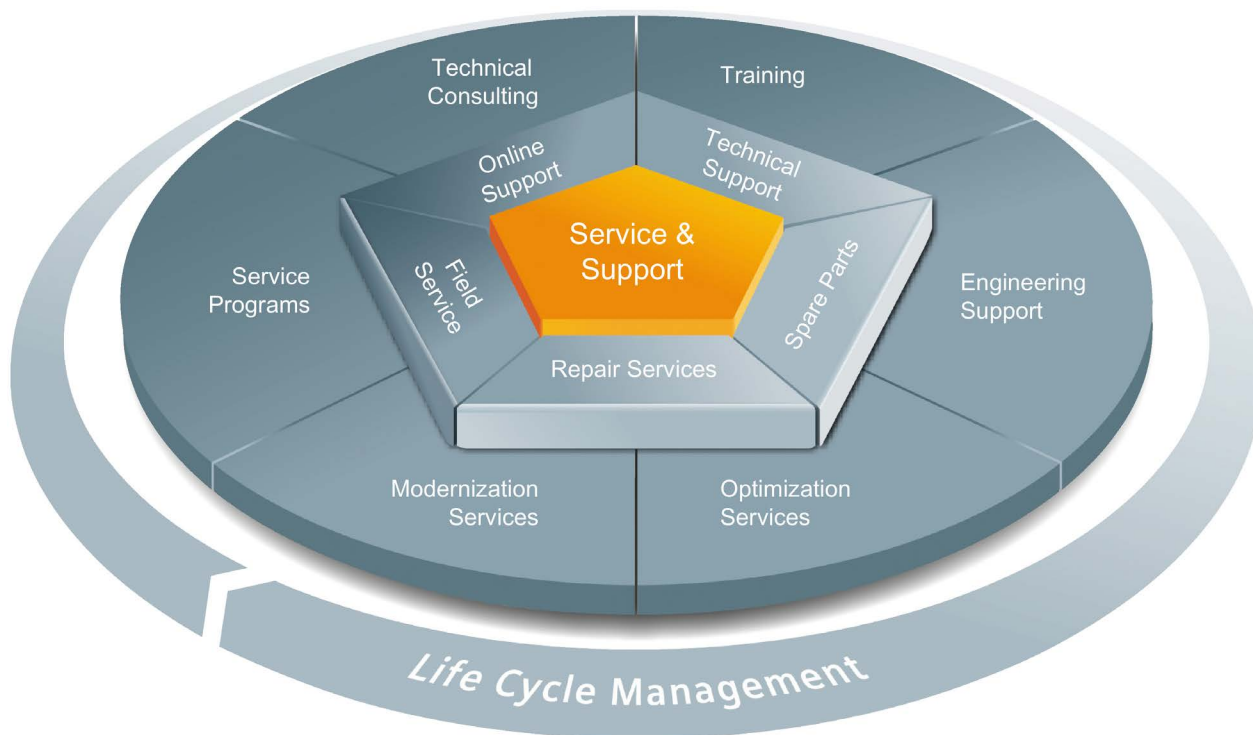
The structure of an ET 200SP consists of an IM 155-6 PN ST, two BaseUnits BU15...D and various input and output modules. The entire ET 200SP is protected with **one** ground-fault detector:

$$R_{\text{ET 200SP}} = \frac{9.5 \text{ M}\Omega}{3} = 3.17 \text{ M}\Omega$$

Figure C-1 Calculation example for leakage resistance

Service & Support

D



The unmatched complete service for the entire life cycle

For machine constructors, solution providers and plant operators: The service offering from Siemens Industry Automation and Drive Technologies includes comprehensive services for a wide range of different users in all sectors of the manufacturing and process industry.

To accompany our products and systems, we offer integrated and structured services that provide valuable support in every phase of the life cycle of your machine or plant – from planning and implementation through commissioning as far as maintenance and modernization.

Our Service & Support accompanies you worldwide in all matters concerning automation and drive technology from Siemens. We provide direct on-site support in more than 100 countries through all phases of the life cycle of your machines and plants.

You have an experienced team of specialists at your side to provide active support and bundled know-how. Regular training courses and intensive contact among our employees – even across continents – ensure reliable service in the most diverse areas

Online Support

The comprehensive online information platform supports you in all aspects of our Service & Support at any time and from any location in the world.

You can find Online Support at the following address Internet (<http://www.siemens.com/automation/service&support>).

Technical Consulting

Support in planning and designing your project: From detailed actual-state analysis, definition of the goal and consultation on product and system questions right through to the creation of the automation solution.

Technical Support

Expert advice on technical questions with a wide range of demand-optimized services for all our products and systems.

You can find Technical Support at the following address: Internet (<http://www.siemens.com/automation/support-request>).

Training

Extend your competitive edge – through practical know-how directly from the manufacturer.

You can find the training courses we offer at the following address: Internet (<http://www.siemens.com/sitrain>).

Engineering Support

Support during project engineering and development with services fine-tuned to your requirements, from configuration through to implementation of an automation project.

Field Service

Our Field Service offers you services for commissioning and maintenance – to ensure that your machines and plants are always available.

Spare parts

In every sector worldwide, plants and systems are required to operate with constantly increasing reliability. We will provide you with the support you need to prevent a standstill from occurring in the first place: with a worldwide network and optimum logistics chains.

Repairs

Downtimes cause problems in the plant as well as unnecessary costs. We can help you to reduce both to a minimum – with our worldwide repair facilities.

Optimization

During the service life of machines and plants, there is often a great potential for increasing productivity or reducing costs.

To help you achieve this potential, we are offering a complete range of optimization services.

Modernization

You can also rely on our support when it comes to modernization – with comprehensive services from the planning phase all the way to commissioning.

Service programs

Our service programs are selected service packages for an automation and drives system or product group. The individual services are coordinated with each other to ensure smooth coverage of the entire life cycle and support optimum use of your products and systems.

The services of a Service Program can be flexibly adapted at any time and used separately.

Examples of service programs:

- Service contracts
- Plant IT Security Services
- Life Cycle Services for Drive Engineering
- SIMATIC PCS 7 Life Cycle Services
- SINUMERIK Manufacturing Excellence
- SIMATIC Remote Support Services

Advantages at a glance:

- Reduced downtimes for increased productivity
- Optimized maintenance costs due to a tailored scope of services
- Costs that can be calculated and therefore planned
- Service reliability due to guaranteed response times and spare part delivery times
- Customer service personnel will be supported and relieved of additional tasks
- Comprehensive service from a single source, fewer interfaces and greater expertise

Contact

At your service locally, around the globe: your partner for consultation, sales, training, service, support, spare parts... for the entire range of products supplied by Industry Automation and Drive Technologies.

You can find your personal contact in our contacts database on the Internet (<http://www.siemens.com/automation/partner>).

Glossary

1oo1 evaluation

Type of → sensor evaluation – in the case of the 1oo1 evaluation, there → is one sensor with a 1-channel connection to the F module.

1oo2 evaluation

Type of → sensor evaluation – in the case of 1oo2 evaluation , two input channels are assigned one two-channel sensor or two one-channel sensors. The input signals are compared internally for equivalence or nonequivalence.

Acknowledgment time

During the acknowledgment time, the → F-I/O acknowledge the sign of life specified by the → F-CPU. The acknowledgment time is included in the calculation of the → monitoring time and → response time of the overall fail-safe system.

Actuator

Actuators can be power relays or contactors for switching on loads, or they can be loads themselves (e.g., directly controlled solenoid valves).

Automation system

Programmable logic controller for the open-loop and closed-loop control of process sequences of the process engineering industry and manufacturing technology. The automation system consists of different components and integrated system functions depending on the automation task.

AUX bus

Self-assembling bus, can be used individually, for example, as a protective conductor bus or for additional required voltage.

Availability

Availability is the probability that a system is functional at a specific point in time. Availability can be increased by redundancy, e.g., by using multiple → sensors at the same measuring point.

BaseUnit

BaseUnits realize the electrical and mechanical connection of the I/O modules with the interface module and the server module.

The inserted I/O module determines the signals at the terminals of the BaseUnits. Depending on the selected BaseUnit, only certain terminals are available.

BaseUnit, dark-colored

Conduction of the internal power and AUX buses from the left adjacent module to the subsequent modules on the right.

BaseUnit, light-colored

Inserted as first BaseUnit and opens a new potential group with electrical isolation. The power and AUX buses are separate from the adjacent module on the left. It feeds the supply voltage.

Baud rate

Data transmission rate; indicates the number of bits transmitted per second (baud rate = bit rate).

BU cover

Cover for unused slots on the BaseUnit or placeholder for planned I/O modules. For a future expansion, the reference identification label of the planned I/O module can be kept here.

Bus

Joint transmission path to which all participants of a fieldbus system are connected; has two defined ends.

BusAdapter

Enables free selection of the connection technology for the PROFINET fieldbus.

Channel fault

Channel-specific fault, such as a wire break or short circuit.

In channel-specific passivation, the affected channel is either automatically reintegrated or the fail-safe module must be removed and reinserted after the fault has been eliminated.

Channel group

The channels of a module are grouped together in a channel group. Certain parameters in STEP 7 can only be assigned to channel groups, rather than to individual channels.

Channel number

Channel numbers are used to uniquely identify the inputs and outputs of a module and to assign channel-specific diagnostic messages.

Channel-specific passivation

With this type of passivation, only the affected channel is passivated in the event of a → channel fault. In the event of a → module fault, all channels of the → fail-safe module are passivated.

Configuration

Systematic arrangement of the individual modules.

Configuration control

Function that enables a flexible adjustment of the actual configuration based on a configured maximum configuration via the user program. Input, output and diagnostics addresses remain unchanged.

Connecting to common potential

Configuring a new potential group for which a new infeed is set up for the supply voltage.

Connection plug

Physical connection between device and cable.

CPU

The CPU uses the integrated system power supply to supply the electronics of the modules via the backplane bus. The CPU contains the operating system and executes the user program. The user program is located on the SIMATIC memory card and is processed in the work memory of the CPU. The PROFINET interfaces of the CPU establish an Industrial Ethernet connection. The CPUs of the ET 200SP support operation as an IO controller, I-device or standalone CPU.

CRC

Cyclic Redundancy Check

CRC signature

The validity of the process values in the safety frame, the accuracy of the assigned address references, and the safety-related parameters are validated by means of the CRC signature in the safety frame.

Crimping

Procedure in which two components, e.g. wire end ferrule and cable, are connected with each other by plastic strain.

Dark period

Dark periods occur during shutdown tests and complete bit pattern tests. The fail-safe output module switches test-related zero signals to the active output. This output is then briefly disabled (= dark period). An adequate carrier → actuator will not respond to this and will remain activated.

Derating

See temperature characteristics

Device name

Before an IO device can be addressed by an IO controller, it must have a device name. An IO device is delivered without a device name. An IO device can only be addressed by the IO controller after it has been assigned a device name via the PG/PC or via the topology, e.g. for the transfer of configuration data (such as IP address) during startup or for the exchange of user data during cyclic operation.

Diagnostics

Monitoring functions for the recognition, localization, classification, display and further evaluation of errors, faults and alarms. They run automatically during plant operation. This increases the availability of plants because commissioning times and downtimes are reduced.

Discrepancy analysis

The discrepancy analysis for equivalence/non-equivalence is used for fail-safe applications to prevent errors from time differences between two signals for the same function. The discrepancy analysis is initiated when different levels are detected in two associated input signals (when testing for non-equivalence: the same levels). A check is performed to determine whether the difference (for nonequivalence testing: the same levels) has disappeared after an assignable time period, the so-called discrepancy time. If not, this means that a discrepancy error exists.

The discrepancy analysis compares the two input signals of the 1oo2 sensor evaluation in the fail-safe input module.

Discrepancy time

Configurable time for the → discrepancy analysis. If the discrepancy time is set too high, the fault detection time and → fault reaction time are extended unnecessarily. If the discrepancy time is set too low, availability is decreased unnecessarily since a discrepancy error is detected when, in reality, no error exists.

Distributed I/O system

System with input and output modules that are configured on a distributed basis, far away from the CPU controlling them.

DP

→ [Distributed I/O system](#)

Earth

Conductive earth whose electrical potential can be set equal to zero at any point.

Equipotential bonding

Electrical connection (potential equalization conductor) that brings the bodies of electrical equipment and other conductive bodies to the same or almost the same potential, in order to prevent disruptive or dangerous voltages between these bodies.

Fail-safe modules

ET 200SP modules with integrated safety functions that can be used for safety-related operation (safety mode).

Fail-safe systems

Fail-safe systems (F-systems) remain in a safe state or immediately assume another safe state as soon as particular failures occur.

Fault response time

The maximum fault response time of an F-system defines the interval between the occurrence of any fault and a safe reaction at all affected fail-safe outputs.

For → F-systems overall: The maximum fault response time defines the interval between the occurrence of any fault at any → F-I/O and the safe reaction at the corresponding fail-safe output.

For digital inputs: The maximum fault response time defines the interval between the occurrence of the fault and the safe reaction at the backplane bus.

For digital outputs: The maximum fault response time defines the interval between the occurrence of the fault and the safe reaction at the digital output.

Fault tolerance time

The fault tolerance time of a process is the time a process can be left unattended without risk to life and limb of the operating personnel, or damage to the environment.

Any type of F-system control is tolerated within this fault tolerance time, i.e. the → F-system can control its processes incorrectly or even not at all. The fault tolerance time depends on the type of process and must be determined on a case-by-case basis.

F-CPU

An F-CPU is a central processing unit with fail-safe capability that is permitted for use in SIMATIC Safety. A standard user program can also be run on the F-CPU.

F-I/O

Collective name for fail-safe inputs and outputs available in SIMATIC S7 for integration into the SIMATIC Safety F-system. Available F-I/O modules:

- Fail-safe I/O module for ET 200eco
- Fail-safe signal modules S7-300 (F-SMs)
- Fail-safe modules for ET 200S
- Fail-safe modules for ET 200SP
- Fail-safe DP standard slaves
- Fail-safe PA field devices
- Fail-safe IO devices

Firmware update

Upgrade of firmware for modules (interface modules, I/O modules etc.), e.g. after function extensions, to the newest firmware version (update).

F-monitoring time

→ PROFIsafe monitoring time

F-Systems

→ fail-safe systems

Functional ground

Functional ground is a low-impedance current path between electric circuits and ground. It is not designed as a safety measure but instead, for example, as a measure to improve interference immunity.

Ground

All interconnected, inactive parts of a piece of equipment that cannot accept any dangerous contact voltage, even in the event of a fault.

Grounding

Grounding means connecting an electrically conductive part to a grounding electrode by means of a grounding system.

GSD file

As a Generic Station Description, this file contains all properties of a PROFINET device that are necessary for its configuration in XML format.

I/O modules

All modules that can be operated with a CPU or an interface module.

Identification data

Information that is saved in modules and that supports the user in checking the plant configuration and locating hardware changes.

Interface module

Module in the distributed I/O system. The interface module connects the distributed I/O system via a fieldbus to the CPU (IO controller) and prepares the data for and from I/O modules.

IO-Link

IO-Link is a point-to-point connection to conventional and intelligent sensors/actuators by unshielded standard cables in proven 3-wire technology. IO-Link is downward compatible to all DI/DQ sensors/actuators. Switching status channel and data channel are designed in proven 24 V DC technology.

Line

All the modules attached to a mounting rail.

Load current supply

Supply of modules like the interface module, power supply modules, I/O modules, and (if applicable) sensors and actuators.

MAC address

Device identification unique worldwide, which is already assigned to each PROFINET device in the factory. Its 6 bytes are divided into 3 bytes for the manufacturer ID and 3 bytes for the device ID (serial number). The MAC address is usually legible on the device.

Module fault

Module faults can be external faults (e.g. missing load voltage) or internal faults (e.g. processor failure). Internal faults always require module replacement.

Monitoring time

→ PROFIsafe monitoring time

M-switch

Each fail-safe digital output of ET 200SP F-modules consists of a P-switch DO-P_x (current sourcing) and an M-switch DO-M_x (current sinking). The load is connected between the P-switch and M-switch. The two switches are always activated so that voltage is applied to the load.

Node

Device that can send, receive or amplify data via the bus, e.g. IO device via PROFINET IO.

Nonequivalent sensor

A nonequivalent → sensor is a two-way switch that is connected to two inputs of an → F-I/O (via 2 channels) in → fail-safe systems (for → 1oo2 evaluation of sensor signals).

Parameter assignment

Parameter assignment is the transfer of parameters from the IO controller/DP master to the IO device/DP slave.

Passivation

If an → F-I/O module detects a fault it switches either the affected channel or all channels to a → safe state, i.e. the channels of this F-I/O module are passivated. The F-I/O module signals the detected faults to the → F-CPU.

When passivating channels at F-I/O with inputs, the → F-System provides fail-safe values for the → safety program instead of the process values pending at the fail-safe inputs.

When passivating channels at F-I/O with outputs, the F-system returns fail-safe values (0) to the fail-safe outputs instead of the output values provided by the safety program.

PELV

Protective Extra Low Voltage

Performance Level

Performance Level (PL) according to ISO 13849-1:2006 or EN ISO 13849-1:2008

Potential group

Group of I/O modules that are jointly supplied with voltage.

Prewiring

Wiring the electrics on a mounting rail before the I/O modules are connected.

Process image (I/O)

The CPU transfers the values from the input and output modules to this memory area. At the start of the cyclic program, the signal states of the input modules are transmitted to the process image input. At the end of the cyclic program, the process image output is transmitted as signal state to the output modules.

Product version (ES) = Functional status (FS)

The product version or functional status provides information on the hardware version of the module.

PROFIBUS

PROcess Field BUS, process and fieldbus standard that is specified in IEC 61158 Type 3. It specifies functional, electrical and mechanical properties for a bit-serial fieldbus system. PROFIBUS is available with the following protocols: DP (= Distributed Periphery), FMS (= Fieldbus Message Specification), PA (= Process Automation) or TF (= Technological Functions).

PROFINET

PROcess Field NETwork, open industrial Ethernet standard which continues PROFIBUS and Industrial Ethernet. A cross-manufacturer communication, automation and engineering model by PROFIBUS International e.V., defined as an automation standard.

PROFINET IO controller

Device used to address connected I/O devices (e.g. distributed I/O systems). This means: The IO controller exchanges input and output signals with assigned I/O devices. The IO controller often corresponds to the CPU in which the automation program is running.

PROFINET IO

Communication concept for the realization of modular, distributed applications within the scope of PROFINET.

PROFINET IO device

Distributed field device that can be assigned to one or more IO controllers (e.g. distributed I/O system, valve terminals, frequency converters, switches).

PROFIsafe

Safety-oriented PROFINET I/O bus profile for communication between the → safety program and the → F-I/O module in a → fail-safe system.

PROFIsafe address

Every → fail-safe module has a PROFIsafe address. You have to configure the PROFIsafe address.

PROFIsafe monitoring time

Monitoring time for safety-related communication between the F-CPU and F-I/O

Proof-test interval

Period after which a component must be forced to fail-safe state, that is, it is either replaced with an unused component, or is proven faultless.

Provider-Consumer principle

Principle of data communication on the PROFINET IO: in contrast to PROFIBUS, both parties are independent providers when sending data.

P-switch

→ M-switch

Push-in terminal

Terminal for the tool-free connection of wires.

Redundancy, availability-enhancing

Multiple instances of components with the objective of maintaining component functionality in the event of hardware faults.

Redundancy, safety-enhancing

Multiple availability of components with the aim of exposing hardware faults based on comparison; such as → 1oo2 evaluation in → fail-safe modules.

Reference identification

In accordance with EN 81346, a specific object is clearly referenced in relation to the system to whose components the object belongs. Thus, unique identification of the modules in the entire system is possible.

Reference potential

Potential from which the voltages of the participating circuits are considered and/or measured.

Reintegration

After the elimination of a fault, it is necessary to ensure the reintegration (depassivation) of the → F-I/O. Reintegration (switchover from fail-safe values to process values) occurs either automatically or only after a user acknowledgment in the safety program.

In the case of a fail-safe input module, the process values pending at the fail-safe inputs are made available to the safety program again after reintegration. In the case of a fail-safe output module, the → fail-safe system transfers the output values in the safety program to the fail-safe outputs again.

Safe state

The basic principle of the safety concept in F-systems is the existence of a safe state for all process variables. For the digital F-I/O, for example, the safe state is the value "0".

Safety class

Safety level (Safety Integrity Level) SIL according to IEC 61508:2010. The higher the Safety Integrity Level, the more rigid the measures for prevention of systematic faults and for management of systematic faults and hardware failures.

The fail-safe modules support operation in safety mode up to safety class SIL3.

Safety frame

In safety mode, data are transferred between the → F-CPU and → F-I/O in a safety frame.

Safety function

A mechanism integrated in the → F-CPU and → F-I/O that enables their use in → the fail-safe system SIMATIC Safety.

According to IEC 61508:2010: A safety function is implemented by a safety system in order to maintain or force a system safe state in the event of a specific fault.

Safety mode

Operating mode of → F-I/O that enables → safety-related communication via → safety frames.
→ ET 200SP fail-safe modules can only be used in safety mode.

Safety program

Safety-related user program

Safety-related communication

Communication used to exchange fail-safe data.

Self-assembling voltage buses

Two internal, self-assembling buses (P1 and P2) that supply the I/O modules with voltage.

SELV

Safety Extra Low Voltage

Sensor evaluation

There are two types of sensor evaluation:

→ 1oo1 evaluation – sensor signal is read once

→ 1oo2 evaluation – sensor signal is read in twice by the same F-module and compared internally

Sensors

Sensors are used for accurate detection of digital and analog signals as well as routes, positions, velocities, rotational speeds, masses, etc.

Server module

The server module completes the configuration of the ET 200SP.

SIL

Safety Integrated Level → safety class

Slave station

A slave can only exchange data after being requested to do so by the master.

SNMP

SNMP (Simple Network Management Protocol) is the standardized protocol for diagnosing and also configuring the Ethernet infrastructure.

In the office area and in automation technology, devices support a wide range of manufacturers on the Ethernet SNMP.

SNMP-based applications can be operated on the same network in parallel to applications with PROFINET.

Standard mode

Operating mode of F-I/O in which standard communication is possible by means of → safety frames, but not → safety-related communication.

Fail-safe ET 200SP modules can only be operated in safety mode.

Switch

PROFIBUS is a linear network. The communication nodes are linked by means of a passive cable - the bus.

By contrast, Industrial Ethernet consists of point-to-point connections: each communication node is interconnected directly with precisely one other communication node.

If a communication node is linked to several communication nodes, this communication node is connected to the port of an active network component - the switch. Other communication devices (including switches) can then be connected to the other ports of the switch. The connection between a communication node and the switch remains a point-to-point connection.

The task of a switch is thus to regenerate and distribute received signals. The switch "learns" the Ethernet address(es) of a connected PROFINET device or additional switches and only forwards those signals that are intended for the connected PROFINET device or switch.

A switch has a specific number of connections (ports). You connect at most one PROFINET device or additional switch to each port.

Technology object

A technology object supports you in the configuration and commissioning of a technological function.

The properties of real objects are represented by the technology objects in the controller. Real objects can be, for example, controlled systems or drives.

The technology object includes all data of the real object that is required for its open-loop or closed-loop control, and it signals the status information.

TIA Portal

Totally Integrated Automation Portal

The TIA Portal is the key to the full performance capability of Totally Integrated Automation. The software optimizes all operating, machine and process sequences.

Total current

Sum of the currents of all output channels of a digital output module.

TWIN wire end ferrule

Wire end ferrule for two cables

Value status

The value status is the binary additional information of a digital signal. The value status is entered in the process image of the input and provides information on the validity of the signal.

Index

2

24 V DC supply, 50
2xSCRJ BusAdapter, 74

A

Accessories, 245
Addressing, 102
 Basics, 102
Approvals, 230
AUX bus (AUXiliary bus), 33

B

BA 2xLC BusAdapter, 81
BaseUnit, 23, 26
 Modules with temperature measurement, 30
 Modules without temperature measurement, 29
 Mounting, dismantling, 45
 Potential group, 32, 35
 Replacing the terminal box, 209
 Types, 26
 wiring, 62
 Wiring rules, 60
BU cover
 Description, 24
 Installation, 90
BusAdapter, 22

C

Cable shield, 64
Changing type
 Coding element, 206
 I/O module, 207
Climatic environmental conditions, 241
Color identification label, 93
 Description, 25
 Installing, 94
Commissioning, 168, 170, 175
 Removing/inserting a SIMATIC memory card, 180
 Reset to factory settings, 220
 Startup, 180

Components

ET 200SP at a glance, 20
In accordance with DIN VDE regulation, 56

Configuration, 14

Basics, 100
Electrical, 58
On grounded reference potential, 55

Configuration control, 142

Configuration example, 170, 172, 174, 175, 177, 179

Configuration software, 97

Configuring, 97

Properties of the CPUs, 101

Connecting

Bus adapter BA 2xRJ45 to interface module, 68
Cable shield, 64

Connecting BA 2xSCJR/FC BusAdapter, 79

Connecting BA LC/FC BusAdapter, 86

Connecting BA LC/RJ45 BusAdapter, 84

Connecting BA SCRJ/RJ45 BusAdapter, 77

Connecting BusAdapter BA 2xRJ45, 68

Connecting the PROFIBUS DP interface to the interface module, 89

Control data record, 152

S7-1500, 150

CPU

Backup/restore contents, 107
Reading out service data, 227
Reset to factory settings, 217

D

Degree of protection, 242

Dimensional diagram

Labeling strip, 243
Reference identification label, 244
Shield connector, 243

E

Electrical isolation, 58

Electrical relationships, 58

Electromagnetic compatibility (EMC), 235

EMC (Electromagnetic compatibility), 235

EMERGENCY STOP devices, 49

Environmental conditions

Climatic, 241
Mechanical, 240

- ET 200SP
 - Area of application, 14
 - Commissioning, 168
 - Components, 20
 - Configuration example, 15, 18
 - Configuring, 97
 - Overall configuration, 57
 - Rules and regulations for operation, 49
 - Selecting a BaseUnit, 26
 - Short-circuit / overload protection, 56
- Example
 - ET 200SP configuration, 15, 18
 - Leakage resistance, 250
 - Potential group, configuration, 37
- F**
 - Factory settings, 217
 - Firmware update, 211
- G**
 - Grounding
 - Configuration on grounded reference potential, 55
 - Graphical overview of ET 200SP, 57
- I**
 - I/O module, 23
 - Changing type, 207
 - Inserting or removing, 203
 - Installation, 90
 - replace, 208
 - Identification data, 191
 - Incoming supply, grounded, 55
 - Installation
 - BaseUnit, 45
 - BU cover, 90
 - I/O module, 90, 203
 - Installation position, 39
 - Interface module, 42
 - Minimum clearances, 41
 - Mounting rail, 40
 - Rules, 42
 - Server module, 48
 - Installation position, 39
 - Insulation, 241
 - Interface module, 21
 - Connecting the supply voltage, 66
 - Mounting, dismantling, 42
 - RESET, 220
 - Reset to factory settings, 220
 - Wiring rules, 60
- L**
 - Labeling strip
 - Dimensional diagram, 243
 - Labeling strips, 25
 - Installing, 96
 - Leakage resistance, 249
 - Lightning protection, 50
 - Line voltage, 49
- M**
 - Maintenance, 203
 - Changing type, 207
 - Firmware update, 211
 - Reading out service data, 227
 - Removal and insertion, 203
 - Replacing modules, 208
 - Replacing the terminal box, 209
 - Reset to factory settings, 217
 - Test functions, 224
 - Marking, 91
 - Color coding, factory setting, 91
 - Optional, 93
 - Maximum configuration, 31
 - Mechanical environmental conditions, 240
 - Memory reset
 - Automatic, 188
 - Basics, 187
 - Manual, 189
 - Minimum clearances, 41
 - Mounting rail, 20, 40
- O**
 - OBs, 120
 - Event source, 121
 - Overload behavior, 123
 - Priorities, 120
 - Priorities and runtime behavior, 122
 - Queue, 120
 - Similar events, 123
 - Start events, 120
 - Threshold mechanism, 124
 - Time error OB, 124
 - Operating modes
 - Basics, 182
 - Operating mode transitions, 186

- RUN, 185
- Setting the startup behavior, 184
- STARTUP, 182
- STOP, 185
- Option handling, (See configuration control)
- Overall configuration, 57
- Overload behavior, 123
- Overview, graphic
 - Grounding the ET 200SP, 57

P

- PELV, 56
- Potential group
 - Configuration example, 37
 - Forming, 32, 35
 - Operating principle, graphical overview, 34, 35
- Process image
 - Inputs and outputs, 104
- Process image partition
 - Updating in the user program, 105
 - updating, automatically, 105
- PROFINET IO, 168
 - Connecting BA LC/FC BusAdapter, 86
 - Connecting BA LC/RJ45 BusAdapter, 84
 - Connecting BA SCRJ/FC BusAdapter, 79
 - Connecting BA SCRJ/RJ45 BusAdapter, 77
 - Connecting BusAdapter BA 2xRJ45, 68
- Protection, 133, 138, 140
 - Access levels, 134
 - Behavior of a password-protected CPU, 136
 - Copy protection, 140
 - Know-how protection, 138
- Protection class, 241, 241

R

- Rated voltage, 242
- Reading out service data, 227
- Reassigning parameters, 190
- Reference identification label, 25, 93
 - Dimensional diagram, 244
 - Installing, 96
- Remove, 203
- Replacement
 - Coding element, 208
 - I/O module, 208
 - Terminal box on the BaseUnit, 209
- Replacing the terminal box, 209
- RESET, 220

- Reset to factory settings, 220
 - with RESET button, 220

S

- Safe electrical isolation, 56
- Server module, 24
 - Mounting, dismantling, 48
- Service & Support, 251
- Shield connection
 - Description, 25
- Shield connector
 - Dimensional diagram, 243
- Shipping conditions, 239
- Short-circuit and overload protection according to DIN VDE regulation, 56
- SIMATIC ET 200SP, 13
- SIMATIC memory card, 196, 201
 - Basics, 196
 - Firmware card, 201
 - Program card, 201
- SIMATIC Memory Card, 202
 - Possible applications, 202
 - Updating firmware, 202
- Spare parts, 245
- Standards, 230
- Starting up the ET 200SP, 180
- Storage conditions, 239
- Supply voltage, 66
 - Connecting, 66
 - Potential group, 32, 35

T

- Technical specifications
 - Climatic environmental conditions, 241
 - Electromagnetic compatibility (EMC), 235
 - Mechanical environmental conditions, 240
 - Shipping and storage conditions, 239
 - Standards and approvals, 230
- Test functions, 224
- Test voltage, 241

W

- Wiring
 - BA LC/FC BusAdapter to interface module, 86
 - BaseUnits, 62
 - Connecting BA 2xSCRJ/FC BusAdapter to interface module, 79

Connecting BA LC/RJ45 BusAdapter to interface
module, 84
Connecting BA SCRJ/RJ45 BusAdapter to interface
module, 77
General rules for ET 200SP, 49
Rules, 60

Z

Zone 2 potentially explosive atmosphere, 242