

You are looking for future communication standards
We connect the future with PROFINET
Let's connect.

Product information



PROFINET – the leading Industrial Ethernet standard

When planning your communications technology do you look out for reliable, future-oriented industry standards? If so, PROFINET technology is just the thing you are looking for, having established itself as THE standard for innovative automation products. Over 20 million nodes have already been installed worldwide and the number continues to grow. As a user you benefit from a large selection of products for your industrial application. What's more, you can be certain you are backing an open and future-proof standard.

For many years now PROFINET has enjoyed a first-class reputation amongst the world's leading industrial companies. Today, no other Industrial Ethernet standard is supported by so many manufacturers as PROFINET. Over 150 manufacturers are already making use of the unparalleled versatility of PROFINET for their devices. A long-term outlook is especially important when it comes to choosing a communications system. So in choosing PROFINET you are making a decision for the future. The large number of manufacturers and products supporting PROFINET guarantee long-term investment protection.

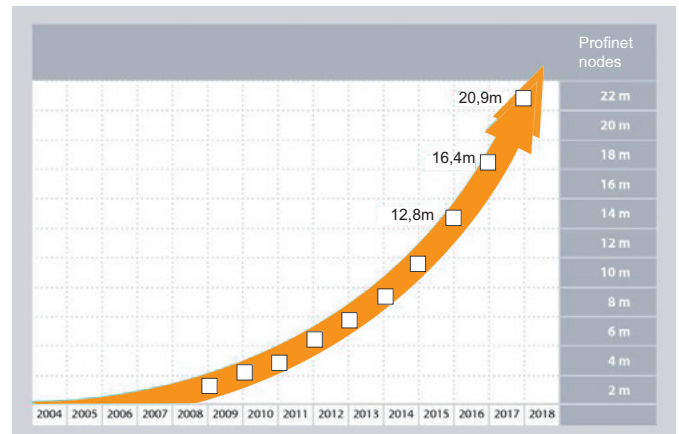

Die Entwicklung der Anzahl an PROFINET-Knoten

The rapidly growing number of devices installed in the field prove that PROFINET is the established Industrial Ethernet standard of the future. 20 million nodes were counted until the end of the year 2018; further strong growth can be expected.



AIDA –

Automation Initiative of German Domestic Automobile Manufacturers

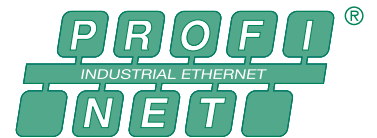
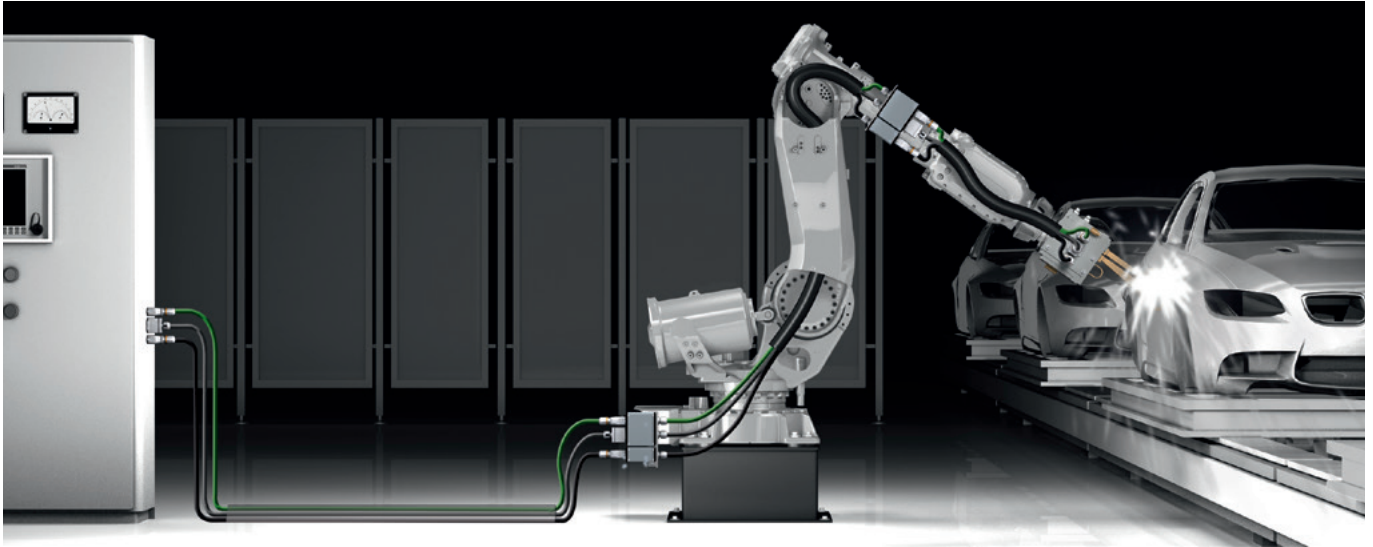

A coherent platform for power, signals and data

PushPull connectors and Weidmüller's FreeCon junction boxes are the basis of the cabling standard in the automotive industry. The PushPull connectors are an integral part of the power-signal-data installation system for AIDA (Automation Initiative of the German Automotive Industry). The cabling standard for PROFINET installations in the automotive industry was established on this basis – and so it naturally includes all the benefits of **STEADYTEC**® technology!

STEADYTEC®: systematic benefits

- Cat.6_A 10 GBit System, Class E_A
- No tools required for field assembly
- Countless variations thanks to highly diverse combinations of inserts
- Unlimited compatibility owing to conformity with IEC 61076-3-106/117
- Reliable and durable zinc die-cast construction
- Industrial usage possible thanks to IP67
- Simple ordering procedure and low inventory costs thanks to Weidmüller's modular system

Cabling solution for AIDA/PROFINET

The installation concept

Typical cable assembly from the control cabinet to the robot head

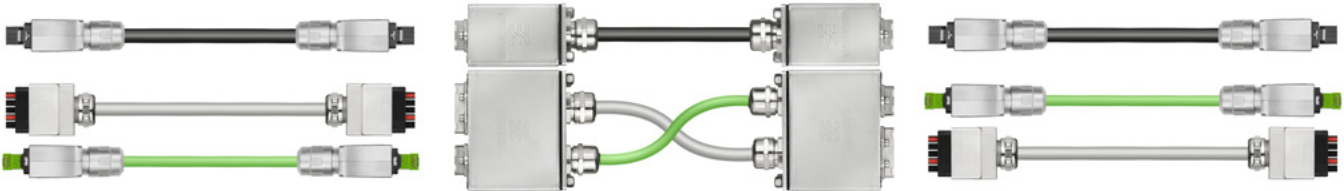

Hose package from the control cabinet to the robot base

Hose package from the robot base to axis 3

Hose package from axis 3 to the robot head

The installation system for the robotics cabling is comprehensive and complies with the PROFINET cabling guideline. Precisely matched pluggable individual components minimise installation efforts by up to 50%.

The integrated concept for the connection of power, signals and data contains three steps: a cable packet is used to connect the cabinet to the robot base. A hose package is inserted between the robot base and axis 3. From there you connect the robot head using another hose package.

This innovative installation concept allows you to drastically reduce the amount of time required for the initial assembly. And when it comes to servicing you will be able to replace a defective hose package quickly and easily.

PushPull connectors enable power, signal and data lines to be replaced in an instant. The sturdy metal housings for the plug-in connectors are designed for use in harsh industrial environments and guarantee maximum service life.

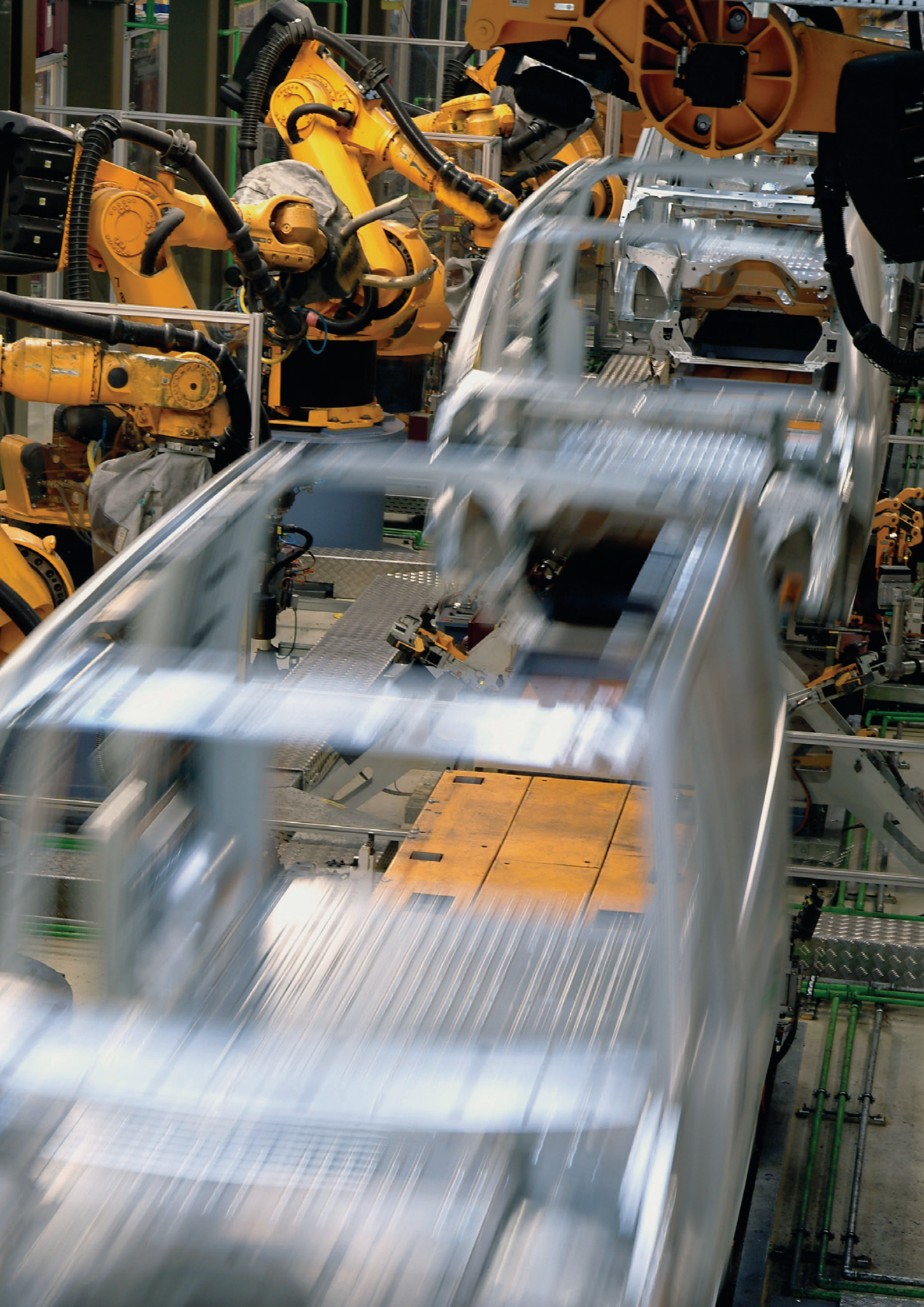

Cabling solution for AIDA/PROFINET

FreeCon cabling components



Based on PROFINET technology, Weidmüller offers cabling and connection components for the industrial environment. This ensures compatibility between different systems and guarantees fast data communication in real time. The FreeCon junction boxes also provide you an extremely flexible installation system for robotic cabling and other industrial applications.

PROFINET – The basis

The wiring components for copper and fibre-optic cables are designed and tested for use in harsh industrial environments. In the PROFINET guidelines the interfaces to be used are clearly defined so as to ensure interoperability between systems. For PROFINET this is guaranteed through the manufacturer's declaration. Comprehensive protection against electromagnetic interference is achieved through the use of high-quality shielding of both cables and connection components. Significant system reserves are offered through the quad-star stranding of the cables and their wire cross-section of AWG 22. Minimal signal propagation time differences resulting from the cable structure guarantee stable real-time transmission, for applications such as PROFINET IRT. At the same time, the cables offer high crush resistance for reliable installation in industrial applications.

The cabling components are also easy to handle in the field. This means that the plug-in connectors for copper and fibre-optic cables can all be assembled on site. This reduces installation times, eliminates errors and simplifies maintenance.

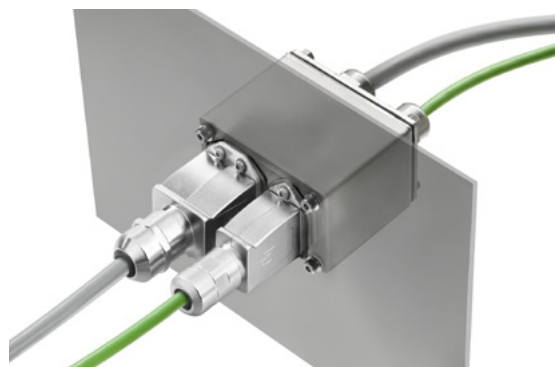
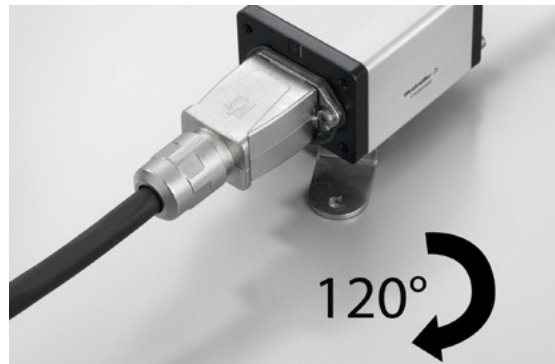
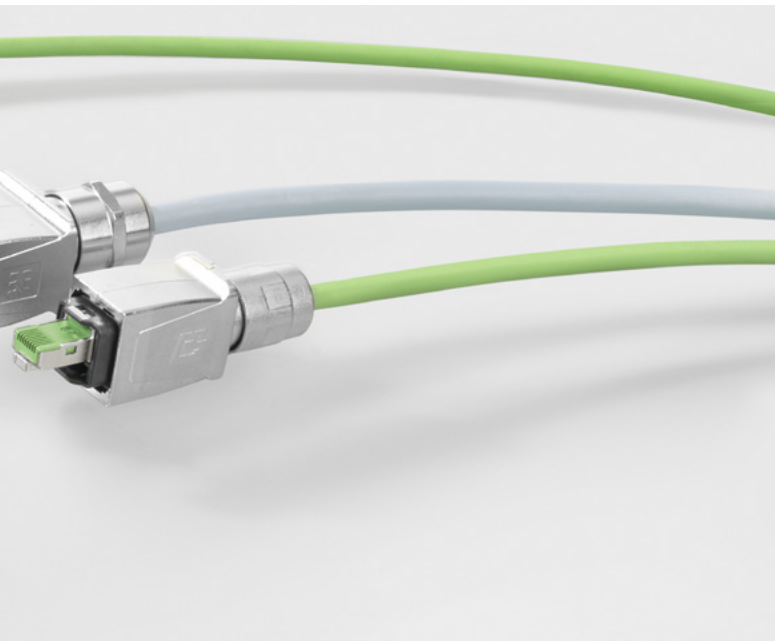

FreeCon – The solution

Weidmüller's FreeCon junction boxes provide numerous mounting options so that you can always be sure of getting the optimum cable route. There are two M4 threaded fittings on the bottom side which allow the FreeCon junction box to be screwed on to a floor panel. These threads are also used for attaching the mounting foot.

This allows the connector to be positioned within a 120° angle range. The hose package can thus be properly routed within the range of the the robot's axis 3.

It can also be mounted on the front using four M4 screws. The cable packet can then be guided through a panel or a wall, for example. A mounting cut-out is required in such cases. This installation system is suitable not only for robotics cabling, but also for other applications which require a rugged, reliable and pluggable cable solution.

Cabling solution for AIDA/PROFINET

Data transmission – copper

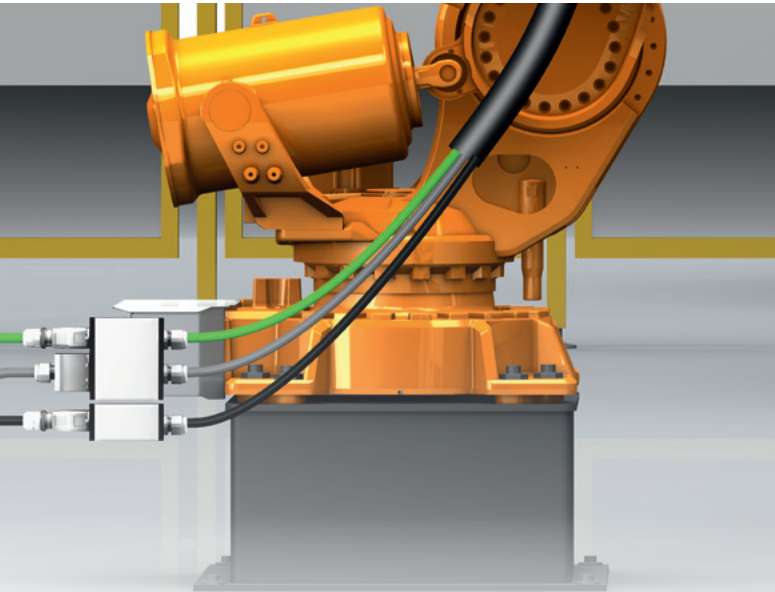

For the transmission of data via copper cable, we recommend our proven, reliable and powerful **STEADYTEC®** technology. The simple assembly of the connectors without the need for special tools makes wiring less time-consuming, which in turn reduces costs. The connectors are clearly marked and have a 4-pole design for PROFINET to prevent the wires from being mixed up.

For use in the field, we have enclosed these properties in a sturdy IP67 housing, variant 14. The connector is therefore well-protected and can even be used in the harshest of environments.

The comprehensive FreeCon Passive connection/coupling elements significantly extend the application options. In the double junction box or double coupling versions, power (24 V / 16 A) and PROFINET/RJ45 are transmitted simultaneously in a single housing. This saves space and reduces installation times. Here too, FreeCon offers the familiar flexible installation options such as the rotatable mounting foot or the alternative fastening option via a cut-out in the mounting plate. The flanges are also fitted with an arrester strap to prevent the protective cap from being lost. The strap is integrated in the flange gasket and does not need to be installed separately.

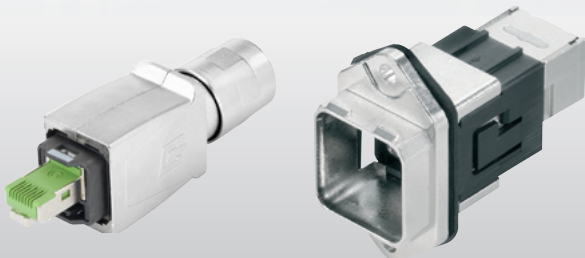

PushPull data connectors for Ethernet or PROFINET transmission, max. 8 x AWG22, Cat.6_A



FreeCon active PROFINET repeater for PushPull Var.14 connectors according to IEC 61076-3-117 with RJ45 and PushPull Power according to PROFINET-specification.



IP20 RJ45: field assembly connectors for Ethernet or PROFINET for use in control cabinets



FreeCon: junction box/coupling and cable coupler for PushPull signal or PushPull data connectors. Installation options: at the front on a mounting plate or with supplemental mounting foot. Installation of the cable coupler: flying or with additional support frame



FreeCon: combined double junction box/coupling for PushPull power and PushPull data connectors, installation options: at the front on a mounting plate or with a mounting foot.

Cabling solution for AIDA/PROFINET

Data transmission – fibre-optic

Fibre-optic cables based on POF (plastic optical fibre) offer all the well-known advantages of fibre-optic technology, with the exception of the longer distances that are possible with GOF (glass optical fibre). This means that potential equalisation currents or EMC-related issues are eliminated from the outset. The great advantage of POF is its ease of assembly. In combination with the HTX-IE-POF crimping tool, preparing a plug connector becomes a simple exercise.

One of the properties of POF is that attenuation steadily increases over the operating life. By measuring this attenuation online you can determine in advance when a cable needs to be replaced. Unlike with copper cabling, this makes planned preventive maintenance a possibility. FreeCon Active Repeater and Media Converter both have attenuation measurement integrated into their design. The value can be read in the PLC via PROFINET and automatically forwarded to your service personnel. In this way you can accurately monitor the current state of deterioration.

POF technology offers considerable advantages with regard to connectivity, EMC and preventive maintenance. To enable you to enjoy these benefits with devices that only have an RJ45 connection, we offer the IP65 media converter, which transforms the RJ45 data signals to SCRJ/POF.

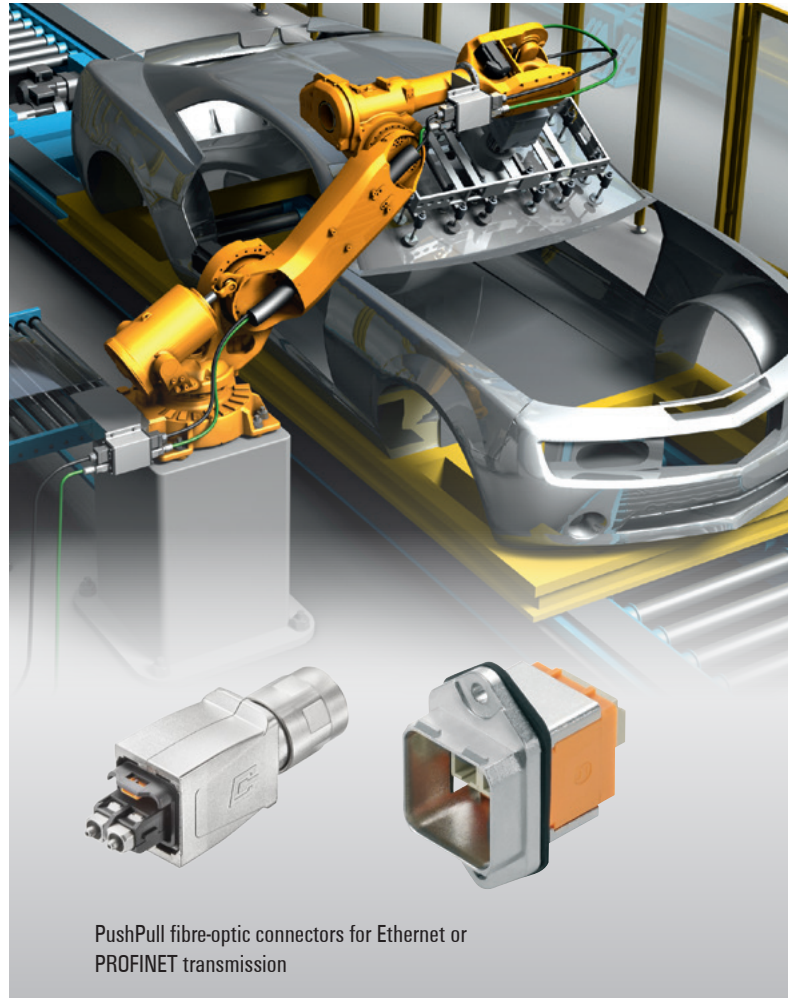

PushPull fibre-optic connectors for Ethernet or PROFINET transmission



IP20 fibre-optic connectors for Ethernet or PROFINET transmission for use in the control cabinet

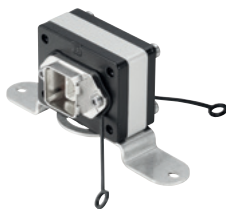

FreeCon: coupling for PushPull fibre-optic connectors. Installation options: at the front on a mounting plate or with a mounting foot



FreeCon active PROFINET POF repeater for PushPull Var.14 connectors according to IEC 61076-3-117 with SCRJ and PushPull Power according to PROFINET-specification.



HTX-IE-POF multifunctional tool for stripping, crimping and cutting 1 mm thick polymer optical fibres specifically for the SC-RJ connector

Cabling solution for AIDA/PROFINET

Power transmission

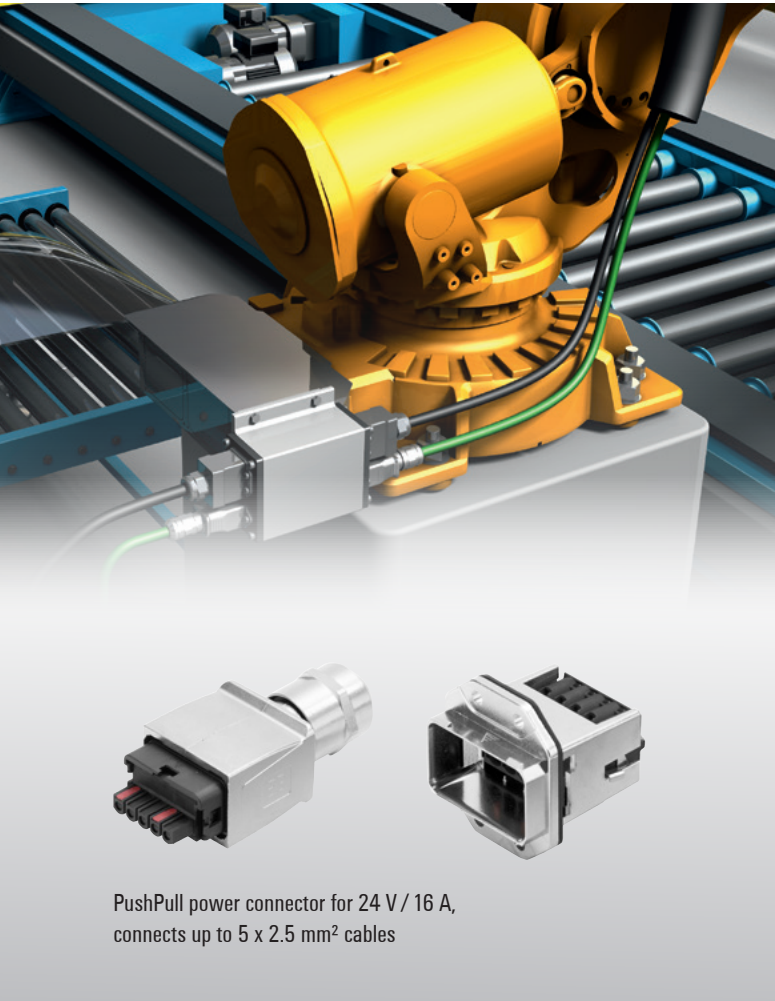

PushPull power connector for 24 V / 16 A, connects up to 5 x 2.5 mm² cables

Power plug-in connectors feature the simple tension clamp connection system. The robust metal housing in IP67 is guaranteed for use in harsh industrial environments.

The comprehensive FreeCon Passive connection/coupling elements clearly extend the application options even further. The Y-distributor, for example, enables a pluggable power bus to be set up with a stub, allowing devices to be replaced without disconnecting the power supply.

Here too, FreeCon provides the familiar flexible installation options such as the rotatable mounting foot or the alternative attachment via a cut-out in the mounting plate.

In the double junction box or double coupling version, power (24 V / 16 A) and PROFINET/RJ45 are transmitted simultaneously. This means that both time and space can be saved thanks to the easier installation.



FreeCon: Cable coupler and combined double junction box for PushPull Power and PushPull data connectors, optional mounting options: at the front on a mounting plate or with a mounting foot. Installation of the cable coupler: flying or with additional support frame

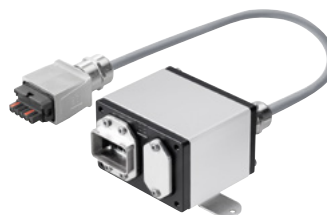

FreeCon Passive Power – Y-distributor for conveniently supplying power to PROFINET IP67 devices. The 5-pole power connector allows the simultaneous transmission of 2 x 24 V / 16 A



FreeCon: coupling for PushPull power connectors. Installation options: at the front on a mounting plate or with a mounting foot

Cabling solution for AIDA/PROFINET

Signal transmission

In collaboration with members of AIDA, Weidmüller has developed the all-purpose signal connector in the proven PROFINET PushPull housing. The way has now been cleared for inclusion in the PROFINET specification as well as in the international IEC standard.

The insert has 10 contacts, each of which can transmit up to 3 A of current. The configuration can be selected freely for specific applications. When used within the AIDA application, however, there is a fixed allocation.

The contacts are supplied on a roll of 300 pieces. For connecting the wires you require our HTF HYB crimping tool.



PushPull signal connector, 10-pole for analogue signals, low-level voltages or fieldbus, crimp contacts with wire cross-sections from 0.08 to 0.75 mm²

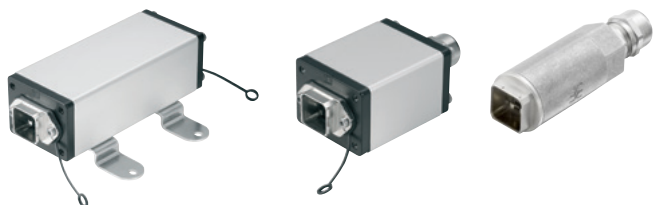

FreeCon: junction box/coupling and cable coupler for PushPull hybrid connector optional mounting options: at the front on a mounting plate or with a mounting foot. Installation of the cable coupler: flying or with additional support frame

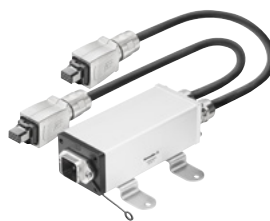

FreeCon: hybrid distributor, special design for aluminium welding



Crimping tool for hybrid contacts ensures perfect crimping results

Cabling solution for AIDA/PROFINET

All your wiring needs

In addition to plug-in connectors, Weidmüller offers a wide assortment of products for a complete Industrial Ethernet cabling solution:

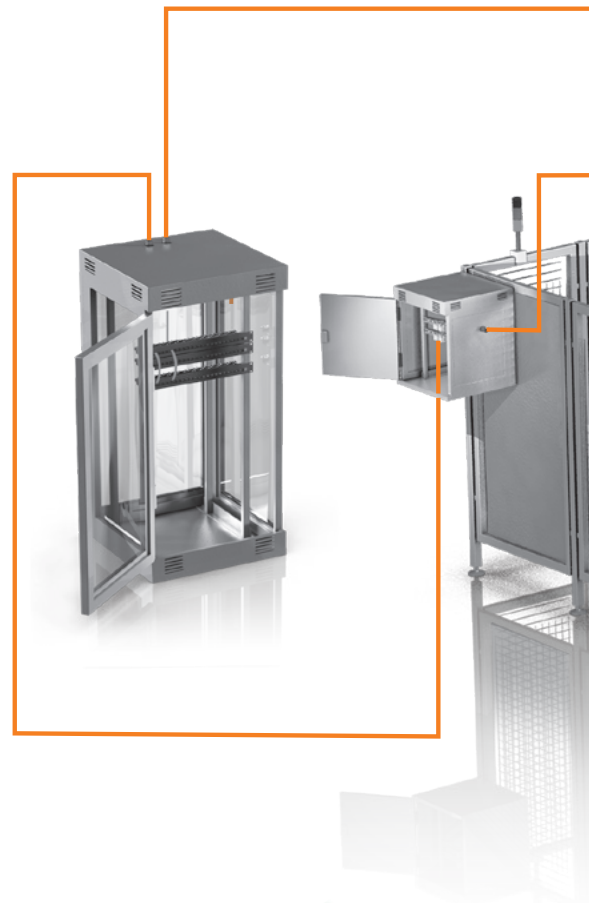

Copper and fibre-optic cable by the metre



IP65 service interfaces



plug RJ45 crimp



IP20 assembled fibre-optic cables



IP20 assembled RJ45 cables



IP20 assembled RJ45 Crimp cables



IP20 mounting rail outlets



IP67 assembled RJ45 cables



IP67 assembled RJ45 cables (molded)



IP67 assembled M12 Cat.6_A cables



IP67 assembled M12 cables

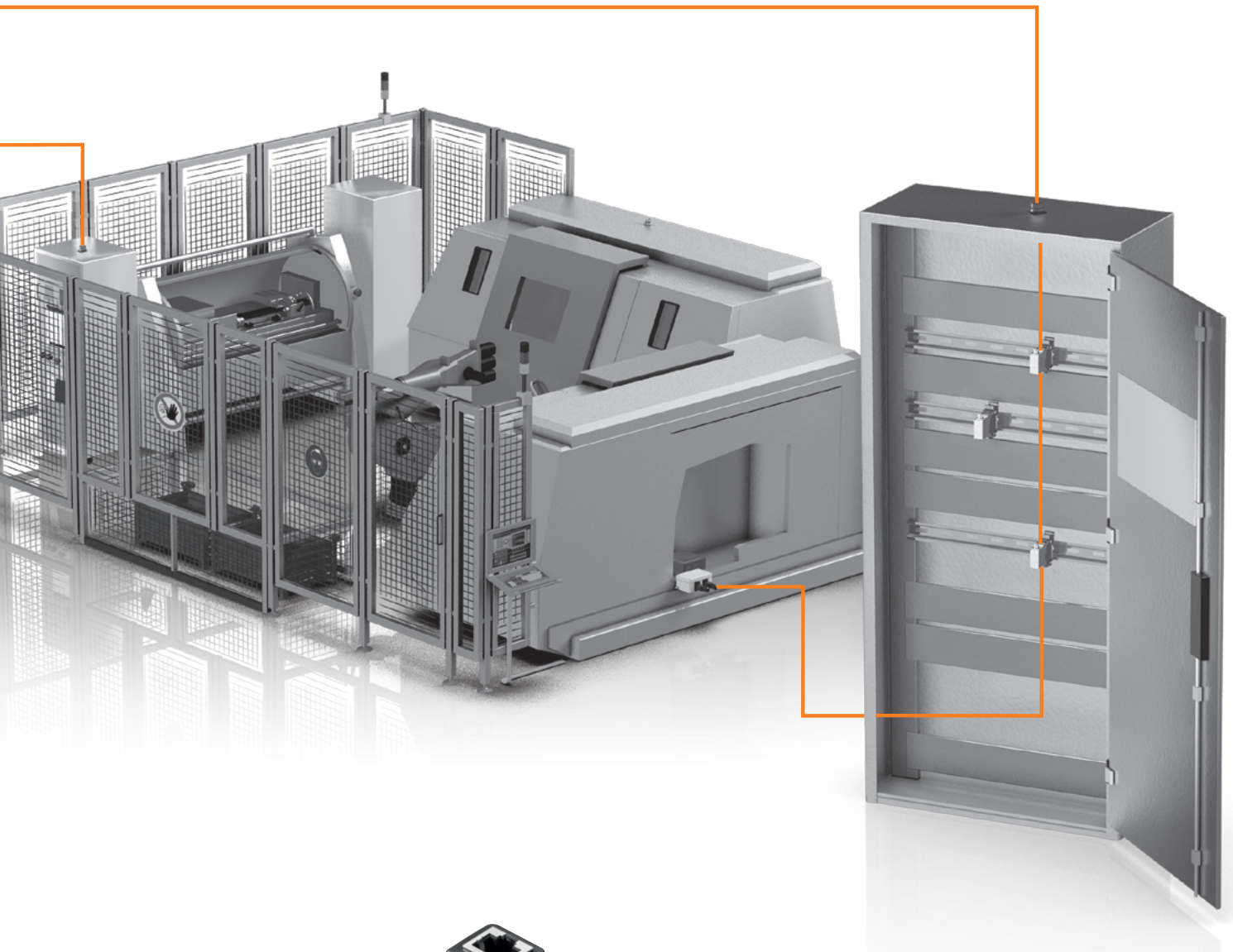

IP67
M12 Cat.6_A plug-in connector



IP67
M12 plug-in connector

Did you know:

... that you can put together the right cable for your application quickly and easily with the aid of our "Galaxy" cable configurator? There's no additional cost, even if you only need one item.

<http://galaxy.weidmueller.com>

PROFINET products

Selection table

IP20 plug-in connector

	Description	Type	Order No.
	RJ45 tool-free PROFINET printing	IE-PS-RJ45-FH-BK-P	1132060000
	RJ45 tool-free angled Profinet printing	IE-PS-RJ45-FH-90-P-1.6	1518100000
	SC-RJ for POF fibres 1 mm	IE-PS-SCRJ1-POF	1206720000
	SC-RJ for multimode fibres 50/62.5 µm	IE-PS-SCRJ1-MM	1206730000
	SC-RJ for singlemode fibres 9 µm	IE-PS-SCRJ1-SM	1206740000

IP20 assembled data cables

	Description	Type	Order No.
	RJ45 patch cable PVC type B - 1 m	IE-C5DS4VG0010A60A60-E	1522100010
	RJ45 patch cable PVC type B - 3 m	IE-C5DS4VG0030A60A60-E	1522100030
	RJ45 patch cable PVC type B - 5 m	IE-C5DS4VG0050A60A60-E	1522100050
	RJ45 patch cable PVC type B - 10 m	IE-C5DS4VG0100A60A60-E	1522100100
	SC-RJ zipcord patch cable - POF - 1 m	IE-FPOZ2EE0001MSJOSJO-X	1273430010
	SC-RJ zipcord patch cable - POF - 3 m	IE-FPOZ2EE0003MSJOSJO-X	1273430030
	SC-RJ zipcord patch cable - POF - 5 m	IE-FPOZ2EE0005MSJOSJO-X	1273430050
	SC-RJ zipcord patch cable - POF - 10 m	IE-FPOZ2EE0010MSJOSJO-X	1273430100
	Further PROFINET cables can be found in our catalogue No. 9 "Industrial Ethernet" in Chapter L		

IP20 mounting rail outlets

	Description	Type	Order No.
	RJ45 coupling	IE-TO-RJ45-C	8946920000
	RJ45 module PROFINET printing	IE-TO-RJ45-FJ-P	8946950000
	SC-RJ POF coupling / multimode	IE-TO-SCRJ-MMM	8946990000
	SC-RJ singlemode coupling	IE-TO-SCRJ-SM	8947000000

IP65 service interface

	Beschreibung	Type	Order No.
	FrontCom® Micro RJ45 coupling	IE-FCM-RJ45-C	1018790000
	FrontCom® Micro RJ45 module PROFINET printing	IE-FCM-RJ45-FJ-P	1018830000

IP67 flange data

	Description	Type	Order No.	
	PushPull standard flange RJ45 coupling	IE-BSS-V14M-RJ45-C	1012310000	
	PushPull central cable gland RJ45 coupling	IE-BSC-V14M-RJ45-C	1058250000	
	PushPull standardised flange RJ45 module PROFINET printing	IE-BSS-V14M-RJ45-FJ-P	1085260000	
	PushPull standardised flange hybrid (Q10) 10-pole module without contacts	IE-BSS-V14M-HYB-10P-FJ	1072900000	
	Contacts for Hybrid (Q10) module 0.5 mm ² - 0.75 mm ² VPE 300	IE-BIC-HYB-P-Q,75-300	1068970000	
	Contacts for Hybrid (Q10) module 0.2 mm ² - 0.5 mm ² VPE 300	IE-BIC-HYB-P-0,5-300	1096150000	
	PushPull standardised flange SC-RJ coupling POF / multimode	IE-BSS-V14M-SCRJ-MM-C	1058120000	
	PushPull standardised flange SC-RJ coupling singlemode	IE-BSS-V14M-SCRJ-SM-C	1058140000	
	PushPull central cable gland SC-RJ coupling POF / multimode	IE-BSC-V14M-SCRJ-MM-C	1062590000	
	PushPull central cable gland SC-RJ coupling singlemode	IE-BSC-V14M-SCRJ-SM-C	1062600000	
	PushPull device flange	IE-BHD-V14M	1047940000	
	PushPull flange protective cap IP 67	IE-BP-V14P	1058310000	
	Other inserts can be found in our catalogue No. 9 "Industrial Ethernet" in Chapter J			

IP67 Power connectors

	Description	Type	Order No.
	PushPull Power with 24 V / 16 A use	IE-PS-VAPM-24V	1068910000
	PushPull Power with 400 V / 16 A use	IE-PS-VAPM-400V	1323940000

IP67 flange power

	Description	Type	Order No.
	PushPull Power standardised flange with 24 V / 16 A use	IE-BSS-VAPM-24V	1069030000
	PushPull Power standardised flange with 400 V / 16 A use	IE-BSS-VAPM-400V	1323950000
	PushPull Power device flange	IE-BHD-VAPM	1068920000
	PushPull Power flange protective cap IP 67	IE-BP-VAPP	1068930000

IP67 data connectors

	Description	Type	Order No.
	PushPull RJ45 tool-free module PROFINET printing	IE-PS-V14M-RJ45-FH-P	1012170000
	PushPull Hybrid (Q10) use, 10-pole module without contacts	IE-PS-V14M-HYB-10P	1072910000
	Contacts for Hybrid (Q10) use 0.75 mm ² VPE 300	IE-PIC-HYB-S-0,75-300	1068950000
	Contacts for Hybrid (Q10) use 0.2 mm ² - 0.5 mm ² VPE 300	IE-PIC-HYB-S-0,5-300	1096180000
	PushPull SC-RJ use PDF 1 mm	IE-PS-V14M-2SC-POF	1191550000
	PushPull plug protective cap IP 67	IE-PP-V14P	1058280000

IP67 assembled data cables

	Description	Type	Order No.
	PushPull RJ45 patch cable PUR - Type C - 1 m	IE-C5DD4UG0010A2EA2E-X	1119730010
	PushPull RJ45 patch cable PUR - Type C - 3 m	IE-C5DD4UG0030A2EA2E-X	1119730030
	PushPull RJ45 patch cable PUR - Type C - 5 m	IE-C5DD4UG0050A2EA2E-X	1119730050
	PushPull RJ45 patch cable PUR - Type C - 10 m	IE-C5DD4UG0100A2EA2E-X	1119730100
	Further PROFINET cables can be found in our catalogue No. 9 "Industrial Ethernet" in Chapter L		

IP67 plug connector M12 D-coded and X-Type

M 12 components can be found in our catalogue No. 9 "Industrial Ethernet" in Chapter J

IP65 connection components

	Beschreibung	Typ	Best.-Nr.
	FreeCon passive double junction box RJ45/Power	IE-CD-V14MRJ/VAPM24V-FJ	1068830000
	FreeCon passive single junction box RJ45	IE-CD-V14MRJ-FJ	1068880000
	FreeCon passive single junction box Hybrid (Q10) without contacts	IE-CD-V14MHYB-10P-FJ	1068850000
	Contacts for Hybrid (Q10) module 0.75 mm ² VPE 300	IE-BIC-HYB-P-0,75-300	1068970000
	Contacts for Hybrid (Q10) module 0.2 mm ² - 0.5 mm ² VPE 300	IE-BIC-HYB-P-0,5-300	1096150000
	Mounting foot for junction boxes	IE-CD-MA	1099580000
	FreeCon passive double coupling RJ45/Power	IE-CD-V14MRJ/VAPM24V-C-MA	1068820000
	FreeCon passive single coupling RJ45	IE-CD-V14MRJ-C-MA	1068870000
	FreeCon passive single coupling hybrid (Q10)	IE-CD-V14MHYB-10P-C-MA	1068840000
	FreeCon PushPull Power Y-distributor	IE-CD-VAPM24V-Y-MA	1297010000
	FreeCon PushPull Power single coupling	IE-CD-VAPM24V-C-MA	1397690000
	FreeCon passive single coupling SCRJ	IE-CD-V14MSCRJ-MM-C-MA	1318150000
	FreeCon active FO PROFINET repeater	IE-CDR-V14MSCRJ/VAPM-C II	2455360000
	FreeCon active PROFINET repeater	IE-CDR-V14MRJ/VAPM-C	2581810000
	FreeCon active PROFINET media converter	IE-CDM-V14MRJSCP/VAPM-C	1324440000
	PushPull flange protective cap IP 67	IE-BP-V14P	1058310000
	FreeCon passive cable coupling RJ45	IE-CC-V14M-RJ45-FJ-P	1990600000
	FreeCon passive cable coupling hybrid	IE-CC-V14M-HYB-10P-FJ	1990610000
	Mounting frame FreeCon cable coupling RJ45 / hybrid	IE-CC-V14M-MF	1990620000
	FreeCon passive cable coupling power	IE-CC-VAPM-24V	1990630000
	Mounting frame FreeCon cable coupling power	IE-CC-VAPM-MF	1990640000

Bulk stock copper cable

	Description	Type	Order No.
	100 m ring installation cable PVC type A	IE-C5AS4V1000	8899000000
	Bulk stock installation cable PVC type A from 110 m	IE-C5AS4VG-MW	8955950000
	100 m ring connection cable PVC type B	IE-C5DS4V1000	8898990000
	Bulk stock connection cable PVC type B from 110 m	IE-C5DS4VG-MW	8955560000
	100 m ring dragline cable PUR type C	IE-C5DD4U1000	8899010000
	Bulk stock dragline cable PUR type C from 110 m	IE-C5DD4UG-MW	8947670000
	Torsion cable PUR type C available by the metre from 110 m	IE-C5IT4UG-MW	1103010000
	Bulk stock hybrid cable PVC from 110 m	IE-C5DHAG-MW	1172250000

Bulk stock fibre-optic cable

	Description	Type	Order No.
	Multimode breakout cable 2x50 µm PUR from 50 m	IE-FM5B2UE-MW	8946000000
	POF zip-cord cable 2X980/1000 µm TPE, from 50 m	IE-FPOZ2EE-MW	1242820000
	POF breakout cable 2X980/1000 µm TPE, from 50 m	IE-FPOD2UE-MW	1172280000

Weidmüller – Your partner in Industrial Connectivity

As experienced experts we support our customers and partners around the world with products, solutions and services in the industrial environment of power, signal and data. We are at home in their industries and markets and know the technological challenges of tomorrow. We are therefore continuously developing innovative, sustainable and useful solutions for their individual needs. Together we set standards in Industrial Connectivity.

Weidmüller Interface GmbH & Co. KG
Klingenbergstraße 16
32758 Detmold, Germany
T +49 5231 14-0
F +49 5231 14-292083
www.weidmueller.com

Personal support can
be found on our website:
www.weidmueller.com/contact

Made in Germany



Order number: 2663790000/02/2019/SMK