

# Analogue signal conditioning

Let's connect.

Version 2020



## Dear Customers,

The PDF versions of our catalogues offer practical additional functions, helping you to find your way around our product range and simplifying the ordering process.

In addition to the catalogue, the PDF also contains:

- Internal page links
- Links to the online catalogue

Try it out for yourself. Click the order number to obtain more detailed information and close-up images via your web browser. The links in the PDF file also enable you to go directly to the next desired catalogue page.

Further Weidmüller product catalogues can be accessed by clicking the following:





# Our Orange Selection

## Quick and easy planning

To enable you to react quickly and easily to the requirements of your industrial environment, we have defined a core portfolio of more than 1,500 articles for you – our Orange Selection. The Orange Selection articles are tailored to one another and cover your standard requirements comprehensively.

All Orange Selection articles are "stock items": If you order by 3 p.m., your order will already be on the way the next working day! For even more efficient planning and production processes, we have marked all articles in our online product catalogue **catalog.weidmueller.com** as "always available" and stored the digital product data for the entire range.

By the way: the Orange Selection is of course also available in the Weidmüller Configurator **www.weidmueller.com/configurator**. Our powerful engineering software guides you intelligently and reliably through your selection and configuration process.

Further information and links to our services can be found at:  
**www.weidmueller.com/orange-selection**



# Analogue signal processing

## Catalogue 4.1

### Analogue signal processing

Simple and retrofittable - IoT-terminal

Network-compatible current measuring transducers - ACT20C

Intrinsically safe signal converters - ACT20X

Signal converters and monitoring components - ACT20P

Space-saving signal converters - ACT20M

Signal converters in terminal format - MCZ

Compact standard signal isolators - PicoPak

Signal & serial interface converters - WAVESERIES

Process value displays

Configuration software

Accessories

### Appendix

Service and support

Technical appendix/Glossary

Index

Index Type / Order No.

# Analogue signal processing

## Simple and retrofittable – IoT-terminal

Page A.2



- Retrofit solution
- Narrow and compact tree design
- Cloud integration via MQTT
- Mobile communication with NB-IoT and LTE-M Cat.1

## Network-compatible signal converters – ACT20C

Page B.2



- Separation and conversion of current or voltage signals
- Limit value monitoring, diagnosis, monitoring via Ethernet network
- PC configuration with FDT/DTM software

## Intrinsically safe signal converters – ACT20X

Page C.2



- Analogue and binary signal interfaces to Ex Zone 0 / Division 1
- FDT/DTM software configurable
- 2 channel modules in 22.5 mm housing

## Signal converters and monitoring components – ACT20P

Page D.2



- Separation and conversion of temperature and DC signals (3-way isolation, supply isolators and passive isolators)
- Strain gauge transmitter for reading from load cells
- High levels of galvanic isolation and accuracy

## Space-saving signal converters – ACT20M

Page E.2



- Isolating and converting of temperature signals and DC signals (3-way isolation, supply isolators and passive isolators)
- Up to 2 channels with a width of 6 mm
- Power supply via the CH20M DIN rail bus

## Signal converters in terminal format – MCZ

Page F.2



- Signal converter in terminal format
- Passive isolator, temperature/frequency converter and threshold monitoring
- Simple wiring with pluggable cross-connection channels

## Compact standard signal isolators – PicoPak

Seite G.2



- Saves space in the panel thanks to the narrow 6 mm width
- Passive insulator, loop spliced at the input and output
- Increased operating temperature range -40°C ...+70°C

## Signal & serial interface converters – WAVESERIES

Page H.2



- Separation and conversion of temperature and DC signals (3-way isolation, supply isolators and passive isolators)
- A large selection of standard signal- and measurement isolating transformers
- High level of galvanic isolation

## Process value displays

Page I.2



- Large four-character LED display
- 1/8"-DIN-standard front-panel with IP 65 protection
- Integrated signal converter and trip amplifier

**Configuration software**

Seite J.2



- Supports FDT and FDT2
- Central data management
- Integrated safety
- Device configurator

**Accessories**

Page K.2



- Configuration adapter
- Power-feed modules
- Calibrators

# Quick select – Analogue Signal Conditioning

Selection table

Order No.	Product	Input										Miscellaneous	Sensor feed	Width
		Amount	0...20 mA	4...20 mA	0...10 V	0...5 V	TC	RTD	Frequency					
<b>Network-compatible current measuring transducers – ACT20C</b>														
1510370000	ACT20C-GTW-100-MTCP-S	1										RJ45, Modbus TCP		22.5 mm
1510240000	ACT20C-CMT-10-AO-RC-S	1										0..5/10 A AC/DC		22.5 mm
1510420000	ACT20C-CMT-60-AO-RC-S	1										0..40/50/60 A AC/DC		22.5 mm
2044840000	ACT20C-CML-10-AO-RC-S	1										0..1/5/10 A AC/DC		22.5 mm
1510340000	ACT20C-LBT-10	0												20.6 mm
<b>Intrinsically safe signal converters – ACT20X</b>														
<b>HART® transparent supply isolator</b>														
8965430000	ACT20X-HAI-SAO-S	1	X	X								EX, HART® transparent	X	22.5 mm
2456140000	ACT20X-HAI-SAO-P	1	X	X								EX, HART® transparent	X	22.5 mm
8965440000	ACT20X-2HAI-2SAO-S	2	X	X								EX, HART® transparent	X	22.5 mm
2456150000	ACT20X-2HAI-2SAO-P	2	X	X								EX, HART® transparent	X	22.5 mm
<b>HART® transparent output driver</b>														
8965450000	ACT20X-SAI-HAO-S	1		X								HART® transparent		22.5 mm
2456160000	ACT20X-SAI-HAO-P	1		X								HART® transparent		22.5 mm
8965460000	ACT20X-2SAI-2HAO-S	2		X								HART® transparent		22.5 mm
2456170000	ACT20X-2SAI-2HAO-P	2		X								HART® transparent		22.5 mm
<b>Temperature transducer</b>														
8965470000	ACT20X-HTI-SAO-S	1	X	X			X	X				EX, temperature + mA		22.5 mm
2456180000	ACT20X-HTI-SAO-P	1	X	X			X	X				EX, temperature + mA		22.5 mm
8965480000	ACT20X-2HTI-2SAO-S	2	X	X			X	X				EX, temperature + mA		22.5 mm
2456190000	ACT20X-2HTI-2SAO-P	2	X	X			X	X				EX, temperature + mA		22.5 mm
<b>Pulse isolators with relay output</b>														
8965340000	ACT20X-HDI-SDO-RNO-S	1										EX, Namur initiator, switching signal	X	22.5 mm
2456050000	ACT20X-HDI-SDO-RNO-P	1										EX, Namur initiator, switching signal	X	22.5 mm
8965350000	ACT20X-HDI-SDO-RNC-S	1										EX, Namur initiator, switching signal	X	22.5 mm
2456060000	ACT20X-HDI-SDO-RNC-P	1										EX, Namur initiator, switching signal	X	22.5 mm
8965370000	ACT20X-2HDI-2SDO-RNO-S	2										EX, Namur initiator, switching signal	X	22.5 mm
2456080000	ACT20X-2HDI-2SDO-RNO-P	2										EX, Namur initiator, switching signal	X	22.5 mm
8965380000	ACT20X-2HDI-2SDO-RNC-S	2										EX, Namur initiator, switching signal	X	22.5 mm
2456090000	ACT20X-2HDI-2SDO-RNC-P	2										EX, Namur initiator, switching signal	X	22.5 mm
<b>Pulse isolators with transistor output</b>														
8965360000	ACT20X-HDI-SDO-S	1										EX, Namur initiator, switching signal	X	22.5 mm
2456070000	ACT20X-HDI-SDO-P	1										EX, Namur initiator, switching signal	X	22.5 mm
8965390000	ACT20X-2HDI-2SDO-S	2										EX, Namur initiator, switching signal	X	22.5 mm
2456100000	ACT20X-2HDI-2SDO-P	2										EX, Namur initiator, switching signal	X	22.5 mm
<b>Digital output</b>														
8965400000	ACT20X-SDI-HDO-L-S	1										NPN / PNP switching signal		22.5 mm
2456100000	ACT20X-SDI-HDO-L-P	1										NPN / PNP switching signal		22.5 mm
8965420000	ACT20X-2SDI-2HDO-S	2										NPN / PNP switching signal		22.5 mm
2456120000	ACT20X-2SDI-2HDO-P	2										NPN / PNP switching signal		22.5 mm
8965410000	ACT20X-SDI-HDO-H-S	1										NPN / PNP switching signal		22.5 mm
2456120000	ACT20X-SDI-HDO-H-P	1										NPN / PNP switching signal		22.5 mm
<b>Universal measurement transducers</b>														
8965490000	ACT20X-HUI-SAO-S	1	X	X	X	X	X	X				EX, temperature + mA + V	X	22.5 mm
2456200000	ACT20X-HUI-SAO-P	1	X	X	X	X	X	X				EX, temperature + mA + V	X	22.5 mm
1318220000	ACT20X-HUI-SAO-LP-S	1	X	X	X	X	X	X				EX, temperature + mA + V		12.5 mm



Amount	Output				Relay	Miscellaneous	Configuration	Auxiliary power	Rated voltage	Isolation	Connection system	Special characteristics
	0...20 mA	4...20 mA	0...10 V									
0							Software	24 V DC	30 V	3-way	S	Modbus TCP Gateway
1	X	X	X	X		± 20 mA, Limit value relays	Software	24 V DC	300 V	4-way	S	Through hole current converter
1	X	X	X	X		± 20 mA, Limit value relays	Software	24 V DC	300 V	4-way	S	Through hole current converter
1	X	X	X	X		± 20 mA, Limit value relays	Software	24 V DC	300 V	4-way	S	Current carrying conductor at the terminals
0												Electrical termination on mounting rail bus, ACT20C station
1		X				Status relay	Software	24 V DC	300 V	3-way	S	With ATEX approval, intrinsic safety, HART <sup>®</sup> transparent
1		X				Status relay	Software	24 V DC	300 V	3-way	P	With ATEX approval, intrinsic safety, HART <sup>®</sup> transparent
2		X				Status relay	Software	24 V DC	300 V	3-way	S	With ATEX approval, intrinsic safety, HART <sup>®</sup> transparent
2		X				Status relay	Software	24 V DC	300 V	3-way	P	With ATEX approval, intrinsic safety, HART <sup>®</sup> transparent
1		X				Ex Output, Status relay	Software	24 V DC	300 V	3-way	S	With ATEX approval, intrinsic safety, HART <sup>®</sup> transparent
1		X				Ex Output, Status relay	Software	24 V DC	300 V	3-way	P	With ATEX approval, intrinsic safety, HART <sup>®</sup> transparent
2		X				Ex Output, Status relay	Software	24 V DC	300 V	3-way	S	With ATEX approval, intrinsic safety, HART <sup>®</sup> transparent
2		X				Ex Output, Status relay	Software	24 V DC	300 V	3-way	P	With ATEX approval, intrinsic safety, HART <sup>®</sup> transparent
1	X	X				Status relay	Software	24 V DC	300 V	3-way	S	With ATEX approval, intrinsic safety
1	X	X				Status relay	Software	24 V DC	300 V	3-way	P	With ATEX approval, intrinsic safety
2	X	X				Status relay	Software	24 V DC	300 V	3-way	S	With ATEX approval, intrinsic safety
2	X	X				Status relay	Software	24 V DC	300 V	3-way	P	With ATEX approval, intrinsic safety
1				X		Relay output, Status relay	Software	24 V DC	300 V	3-way	S	With ATEX approval, intrinsic safety
1				X		Relay output, Status relay	Software	24 V DC	300 V	3-way	P	With ATEX approval, intrinsic safety
1				X		Relay output, Status relay	Software	24 V DC	300 V	3-way	S	With ATEX approval, intrinsic safety
1				X		Relay output, Status relay	Software	24 V DC	300 V	3-way	P	With ATEX approval, intrinsic safety
2				X		Relay output, Status relay	Software	24 V DC	300 V	3-way	S	With ATEX approval, intrinsic safety
2				X		Relay output, Status relay	Software	24 V DC	300 V	3-way	P	With ATEX approval, intrinsic safety
2				X		Relay output, Status relay	Software	24 V DC	300 V	3-way	S	With ATEX approval, intrinsic safety
2				X		Relay output, Status relay	Software	24 V DC	300 V	3-way	P	With ATEX approval, intrinsic safety
1						Transistor output, Status relay	Software	24 V DC	300 V	3-way	S	With ATEX approval, intrinsic safety
1						Transistor output, Status relay	Software	24 V DC	300 V	3-way	P	With ATEX approval, intrinsic safety
2						Transistor output, Status relay	Software	24 V DC	300 V	3-way	S	With ATEX approval, intrinsic safety
2						Transistor output, Status relay	Software	24 V DC	300 V	3-way	P	With ATEX approval, intrinsic safety
1						Ex Output, Status relay	Software	24 V DC	300 V	3-way	S	With ATEX approval, intrinsic safety
1						Ex Output, Status relay	Software	24 V DC	300 V	3-way	P	With ATEX approval, intrinsic safety
2						Ex Output, Status relay	Software	24 V DC	300 V	3-way	S	ATEX approval, intrinsic safety ignition protection IIC
2						Ex Output, Status relay	Software	24 V DC	300 V	3-way	P	ATEX approval, intrinsic safety ignition protection IIC
1						Ex Output, Status relay	Software	24 V DC	300 V	3-way	S	ATEX approval, intrinsic safety ignition protection IIB
1						Ex Output, Status relay	Software	24 V DC	300 V	3-way	P	ATEX approval, intrinsic safety ignition protection IIB
1	X	X		X		Limit value relay output, Status relay	Software	24 V DC	300 V	3-way	S	With ATEX approval, intrinsic safety
1	X	X		X		Limit value relay output, Status relay	Software	24 V DC	300 V	3-way	P	With ATEX approval, intrinsic safety
1		X				-	Software	output loop	300 V	2-way	S	With ATEX approval, intrinsic safety

Connection system: S = screw / Z = tension clamp / P = Push In, ILP = Input Loop Powered, OLP = Output Loop Powered

# Quick select – Analogue Signal Conditioning

## Selection table

Order No.	Product	Input										Miscellaneous	Sensor feed	Width
		Amount	0...20 mA	4...20 mA	0...10 V	0...5 V	TC	RTD	Frequency					
<b>Signal converters and monitoring components – ACT20P</b>														
<b>Signal converters</b>														
7760054114	ACT20P-CI-CO-S	1	X	X								2/3-wire transmitter, HART® transparent	X	12.5 mm
2489680000	ACT20P-CI-CO-P	1	X	X								2/3-wire transmitter, HART® transparent	X	12.5 mm
7760054117	ACT20P-2CI-2CO-12-S	2	X	X								4-wire sensor, HART® transparent		12.5 mm
2489730000	ACT20P-2CI-2CO-12-P	2	X	X								4-wire sensor, HART® transparent		12.5 mm
1540010000	ACT20P-CI-VO-S	1	X	X								2/3-/4-wire sensor	X	12.5 mm
2489740000	ACT20P-CI-VO-P	1	X	X								2/3-/4-wire sensor	X	12.5 mm
7760054306	ACT20P-VM-AO-S	1										0...440 V AC, 0...660 V DC		22.5 mm
<b>Passive isolators</b>														
7760054123	ACT20P-CI-CO-ILP-S	1	X	X								4-wire sensor	X	12.5 mm
7760054124	ACT20P-2CI-2CO-ILP-S	2	X	X								4-wire sensor	X	12.5 mm
7760054122	ACT20P-CI-2CO-OLP-S	1		X								4-wire sensor	X	12.5 mm
7760054118	ACT20P-CI1-CO-OLP-S	1	X									4-wire sensor	X	12.5 mm
7760054119	ACT20P-CI2-CO-OLP-S	1		X								4-wire sensor	X	12.5 mm
7760054121	ACT20P-VI-CO-OLP-S	1			X							4-wire sensor	X	12.5 mm
7760054120	ACT20P-VI1-CO-OLP-S	1				X						4-wire sensor	X	12.5 mm
7760054122	ACT20P-CI-2CO-OLP-S	1		X								4-wire sensor	X	12.5 mm
<b>Signal splitters</b>														
7760054115	ACT20P-CI-2CO-S	1	X	X								2/3-/4-wire sensor, HART® transparent	X	12.5 mm
2489710000	ACT20P-CI-2CO-P	1	X	X								2/3-/4-wire sensor, HART® transparent	X	12.5 mm
<b>Temperature transducer</b>														
7760054305	ACT20P-TMR-RTI-S	1						X				PT100		22.5 mm
2448100000	ACT20P-PRO-RTCI-AO-DO-S	1					X	X				RTD, SRTD, Pot, mV, resistance	X	12.5 mm
2448110000	ACT20P-PRO-RTCI-AO-DO-P	1					X	X				RTD, SRTD, Pot, mV, resistance	X	12.5 mm
7940045760	ACT20P-UI-2RCC-DC-S	1	X	X	X	X	X	X				± 25 mA, ± 5 A DC, ± 30 V DC, ± 300 V DC, potentiometer, resistance	X	22.5 mm
2456840000	ACT20P-UI-2RCC-DC-P	1	X	X	X	X	X	X				± 25 mA, ± 5 A DC, ± 30 V DC, ± 300 V DC, potentiometer, resistance	X	22.5 mm
1238910000	ACT20P-UI-2RCC-AC-S	1	X	X	X	X	X	X				± 25 mA, ± 5 A DC, ± 30 V DC, ± 300 V DC, potentiometer, resistance	X	22.5 mm
2495690000	ACT20P-UI-2RCC-AC-P	1	X	X	X	X	X	X				± 25 mA, ± 5 A DC, ± 30 V DC, ± 300 V DC, potentiometer, resistance	X	22.5 mm
<b>Measurement and monitoring relays</b>														
7760054164	ACT20P-VMR-1PH-H-S	1										1 phase 0...400 V AC/DC		22.5 mm
7760054165	ACT20P-VMR-3PH-ILP-H-S	1										3 phases 180...500 V AC		22.5 mm
<b>Current measuring transducers</b>														
2044850000	ACT20P-CML-10-AO-RC-S	1										0...1/5/10 A AC/DC		17.5 mm
2489910000	ACT20P-CML-10-AO-RC-P	1										0...1/5/10 A AC/DC		17.5 mm
1510470000	ACT20P-CMT-10-AO-RC-S	1										0...5/10 A AC/DC		22.5 mm
1510540000	ACT20P-CMT-30-AO-RC-S	1										0...20/25/30 A AC/DC		22.5 mm
1510440000	ACT20P-CMT-60-AO-RC-S	1										0...40/50/60 A AC/DC		22.5 mm
1510390000	ACT20P-CMT-60-RC-S	1										0...40/50/60 A AC/DC		22.5 mm
1510330000	ACT20P-CMT-10-AO-RC-P	1										0...5/10 A AC/DC		22.5 mm
1510320000	ACT20P-CMT-30-AO-RC-P	1										0...20/25/30 A AC/DC		22.5 mm
1510290000	ACT20P-CMT-60-AO-RC-P	1										0...40/50/60 A AC/DC		22.5 mm
1510280000	ACT20P-CMT-60-RC-P	1										0...40/50/60 A AC/DC		22.5 mm
<b>Bridge measuring transducers</b>														
1067250000	ACT20P-BRIDGE-S	1										4,6-wire strain gauge	X	22.5 mm
2456820000	ACT20P-BRIDGE-P	1										4,6-wire strain gauge	X	22.5 mm
<b>Universal measurement transducers</b>														
1481970000	ACT20P-PRO DCDC II-S	1	X	X	X	X						± 100 mA, ± 300 V DC	X	12.5 mm
1481960000	ACT20P-PRO DCDC II-P	1	X	X	X	X						± 100 mA, ± 300 V DC	X	12.5 mm
1453210000	ACT20P-UI-AO-DO-ILP-S	1	X	X	X	X	X	X				± 25 mA, ± 5 A DC, ± 28 V DC, ± 300 V DC, 300 V AC	X	12.5 mm
2456850000	ACT20P-UI-AO-DO-ILP-P	1	X	X	X	X	X	X				± 25 mA, ± 5 A DC, ± 28 V DC, ± 300 V DC, 300 V AC	X	12.5 mm
1477420000	ACT20P-AI-AO-DC-S	1	X	X	X	X						0...11 V, 0...22 mA	X	12.5 mm
2456860000	ACT20P-AI-AO-DC-P	1	X	X	X	X						0...11 V, 0...22 mA	X	12.5 mm

Amount	Output				Relay	Miscellaneous	Configuration	Auxiliary power	Rated voltage	Isolation	Connection system	Special characteristics
	0...20 mA	4...20 mA	0...10 V									
1	X	X					-	24 V DC	300 V	3-way	S	HART® transparent
1	X	X					-	24 V DC	300 V	3-way	P	HART® transparent
2	X	X					-	24 V DC	300 V	3-way	S	HART® transparent
2	X	X					-	24 V DC	300 V	3-way	P	HART® transparent
1			X				-	24 V DC	300 V	3-way	S	
1			X				-	24 V DC	300 V	3-way	P	
1	X	X	X				Software	24...240 V UC	600 V	3-way	S	
1	X	X					-	input loop	300 V	2-way	S	
2	X	X					-	input loop	300 V	4-way	S	
2		X					-	output loop	300 V	3-way	S	
1		X					-	output loop	300 V	2-way	S	
1		X					-	output loop	300 V	2-way	S	
1		X					-	output loop	300 V	2-way	S	
1		X					-	output loop	300 V	2-way	S	
2		X					-	output loop	300 V	4-way	S	
2	X	X					-	24 V DC	300 V	4-way	S	HART® transparent
2	X	X					-	24 V DC	300 V	4-way	P	HART® transparent
2				X		2 x relay outputs (limit value)	Software, Display	20...264 V UC	300 V	5-way	S	
1	X	X	X			analogue and NPN output, Limit value	Display, Button	24...240 V UC	300 V	3-way	S	
1	X	X	X			analogue and NPN output, Limit value	Display, Button	24...240 V UC	300 V	5-way	P	
1				X		2 x Limit value relay output	Software, Display	9...60 V DC	300 V	5-way	S	
1				X		2 x Limit value relay output	Software, Display	9...60 V DC	300 V	5-way	P	
1				X		2 x Limit value relay output	Software, Display	90...264 V AC	300 V	5-way	S	
1				X		2 x Limit value relay output	Software, Display	90...264 V AC	300 V	5-way	P	
2				X		2 x Limit value relay output	DIP switch, potentiometer	20...240 V UC	300 V	5-way	S	
2				X		2 x Limit value relay output	DIP switch, potentiometer	Input loop	600 V	5-way	S	
1	X	X	X	X		± 10 V, ± 20 mA, Limit value relays	DIP switch, potentiometer	24 V DC	300 V	4-way	S	Power cable can be connected to the terminals
1	X	X	X	X		± 10 V, ± 20 mA, Limit value relays	DIP switch, potentiometer	24 V DC	300 V	4-way	P	Power cable can be connected to the terminals
1	X	X	X	X		± 10 V, ± 20 mA, Limit value relays	DIP switch, potentiometer	24 V DC	300 V	4-way	S	Through hole current converter
1	X	X	X	X		± 10 V, ± 20 mA, Limit value relays	DIP switch, potentiometer	24 V DC	300 V	4-way	S	Through hole current converter
1	X	X	X	X		± 10 V, ± 20 mA, Limit value relays	DIP switch, potentiometer	24 V DC	300 V	4-way	S	Through hole current converter
1				X		Limit value relay output	DIP switch, potentiometer	24 V DC	300 V	3-way	S	Through hole current converter
1	X	X	X	X		± 10 V, ± 20 mA, Limit value relays	DIP switch, potentiometer	24 V DC	300 V	4-way	P	Through hole current converter
1	X	X	X	X		± 10 V, ± 20 mA, Limit value relays	DIP switch, potentiometer	24 V DC	300 V	4-way	P	Through hole current converter
1	X	X	X	X		± 10 V, ± 20 mA, Limit value relays	DIP switch, potentiometer	24 V DC	300 V	4-way	P	Through hole current converter
1				X		Limit value relay output	DIP switch, potentiometer	24 V DC	300 V	3-way	P	Through hole current converter
1	X	X	X			Reset button (TARE)	DIP switch, button	10...60 V DC	300 V	3-way	S	
1	X	X	X			Reset button (TARE)	DIP switch, button	10...60 V DC	300 V	3-way	P	
1	X	X	X			± 10 V, ± 20 mA	Display, DIP switch, button	24 V - 230 V AC/DC	600 V	3-way	S	aktiv or passiv output
1	X	X	X			± 10 V, ± 20 mA	Display, DIP switch, button	24 V - 230 V AC/DC	600 V	3-way	P	aktiv or passiv output
1		X				NPN output, Limit value	Software	output loop	300 V	3-way	S	Output Loop powered
1		X				NPN output, Limit value	Software	output loop	300 V	3-way	P	Output Loop powered
1	X	X	X			0...11V, 0...22mA	DIP switch, button, LED	12...60 V DC	300 V	3-way	S	
1	X	X	X			0...11V, 0...22mA	DIP switch, button, LED	12...60 V DC	300 V	3-way	P	

Connection system: S = screw / Z = tension clamp / P = Push In, ILP = Input Loop Powered, OLP = Output Loop Powered

# Quick select – Analogue Signal Conditioning

Selection table

Order No.	Product	Input								Miscellaneous	Sensor feed	Width
		Amount	0...20 mA	4...20 mA	0...10 V	0...5 V	TC	RTD	Frequency			
<b>Space-saving signal converters – ACT20M</b>												
<b>Signal converters</b>												
1175980000	ACT20M-CI-CO-S	1	X	X						4-wire sensor		6.1 mm
1176000000	ACT20M-AI-AO-S	1	X	X	X	X				2,4-wire sensor	X	6.1 mm
1176010000	ACT20M-AI-AO-E-S	1	X	X	X	X				4-wire sensor		6.1 mm
1375450000	ACT20M-BAI-AO-S	1								-10(20)...+10(20) mA, -5(10)...+5(10) V		6.1 mm
<b>Passive isolators</b>												
1176070000	ACT20M-CH-CO-ILP-S	1	X	X						4-wire sensor		6.1 mm
1176080000	ACT20M-2CI-2CO-ILP-S	2	X	X						4-wire sensor		6.1 mm
1176040000	ACT20M-CH-CO-OLP-S	1		X						2-wire transmitter	X	6.1 mm
1176050000	ACT20M-2CI-2CO-OLP-S	2		X						2-wire transmitter	X	6.1 mm
<b>Signal splitters</b>												
1175990000	ACT20M-CI-2CO-S	1	X	X						4-wire sensor		6.1 mm
1176020000	ACT20M-AI-2SAO-S	1	X	X	X	X				2,4-wire sensor	X	6.1 mm
1375470000	ACT20M-BAI-2AO-S	1								-10(20)...+10(20) mA, -5(10)...+5(10) V		6.1 mm
<b>Temperature transducer</b>												
1435590000	ACT20M-RTCI-CO-OLP-S	1					X	X		PT100 Type: J,K		6.1 mm
1435610000	ACT20M-RTI-CO-EOLP-S	1						X		PT100		6.1 mm
1375510000	ACT20M-RTI-AO-S	1						X		PT100		6.1 mm
1375520000	ACT20M-RTI-AO-E-S	1						X		PT100		6.1 mm
1375480000	ACT20M-TCI-AO-S	1					X			Type J,K		6.1 mm
1375500000	ACT20M-TCI-AO-E-S	1					X			Type J,K		6.1 mm
<b>Universal measurement transducers</b>												
1176030000	ACT20M-UI-AO-S	1	X	X	X	X	X	X		PT50/100/250/300/400/1000, Ni50/100/1000 Type: B / C / E / J / K / L / N / R / S / T	X	6.1 mm
<b>Signal converters in terminal format – MCZ</b>												
<b>Frequency signal converters</b>												
8461470000	MCZ VFC 0-10V	1			X					4-wire sensor		6 mm
8461480000	MCZ CFC 0-20mA	1	X							4-wire sensor		6 mm
8461490000	MCZ CFC 4-20mA	1		X						4-wire sensor		6 mm
<b>Limit monitoring</b>												
8260280000	MCZ SC 0-10V	1			X					4-wire sensor		6 mm
8227350000	MCZ SC 0-20mA	1	X							4-wire sensor		6 mm
<b>Passive isolators</b>												
8411190000	MCZ CCC 0-20mA/0-20mA	1	X							4-wire sensor		6 mm
<b>Temperature transducer</b>												
8425720000	MCZ PT100/3 CLP 0...100C	1						X		Measuring range 0...100°C		6.1 mm
8483680000	MCZ PT100/3 CLP 0...120C	1						X		Measuring range 0...120°C		6.1 mm
8604420000	MCZ PT100/3 CLP 0...150C	1						X		Measuring range 0...150°C		6.1 mm
8473010000	MCZ PT100/3 CLP 0...200C	1						X		Measuring range 0...200°C		6.1 mm
8473020000	MCZ PT100/3 CLP 0...300C	1						X		Measuring range 0...300°C		6.1 mm
8473000000	MCZ PT100/3 CLP -50C...+150C	1						X		Measuring range -50...150°C		6.1 mm
8604430000	MCZ PT100/3 CLP -40C...100C	1						X		Measuring range -40...100°C		6.1 mm
<b>Compact standard signal isolators – PicoPak</b>												
2517450000	PICOPAK-CH-CO-LP-S	1		X						4-wire sensor		6.1 mm
2501110000	PICOPAK-CH-CO-LP-P	1		X						4-wire sensor		6.1 mm

Amount	Output				Relay	Miscellaneous	Configuration	Auxiliary power	Rated voltage	Isolation	Connection system	Special characteristics
	0...20 mA	4...20 mA	0...10 V									
1	X	X						24 V DC	300 V	3-way	S	ATEX approval Zone 2
1	X	X	X			DIP switch		24 V DC	300 V	3-way	S	ATEX approval Zone 2
1	X	X	X	X		DIP switch		24 V DC	300 V	3-way	S	ATEX approval Zone 2
1	X	X	X	X		DIP switch		24 V DC	300 V	2-way	S	ATEX approval Zone 2
1	X	X						input loop	300 V	2-way	S	ATEX approval Zone 2, Passive converter
2	X	X						input loop	300 V	2-way	S	ATEX approval Zone 2, Passive converter
1		X						output loop	300 V	2-way	S	ATEX approval Zone 2, Passive converter
2		X						output loop	300 V	2-way	S	ATEX approval Zone 2, Passive converter
2	X	X				DIP switch		24 V DC	300 V	3-way	S	ATEX approval Zone 2
2	X	X	X			DIP switch		24 V DC	300 V	3-way	S	ATEX approval Zone 2
2	X	X	X		-10(20)...+10(20) mA	DIP switch		24 V DC	300 V	2-way	S	ATEX approval Zone 2
1		X			20...4 mA	DIP switch		output loop	300 V	2-way	S	ATEX approval Zone 2, Passive converter
1		X			20...4 mA	DIP switch		output loop	-	-	S	ATEX approval Zone 2, Passive converter
1	X	X	X		0(1)...5 V	DIP switch		24 V DC	300 V	2-way	S	ATEX approval Zone 2
1	X	X			0(1)...5 V	DIP switch		24 V DC	-	-	S	ATEX approval Zone 2
1	X	X	X		interne CJC, externe CJC	DIP switch		24 V DC	300 V	2-way	S	ATEX approval Zone 2
1	X	X	X		interne CJC, externe CJC	DIP switch		24 V DC	-	-	S	ATEX approval Zone 2
1	X	X	X			Software		24 V DC	300 V	3-way	S	ATEX approval Zone 2
1					Frequency: 0...1/ 4/ 8/ 16 kHz	DIP switch		24 V DC	100 V	2-way	Z	Frequency output
1					Frequency: 0...1/ 4/ 8/ 16 kHz	DIP switch		24 V DC	100 V	2-way	Z	Frequency output
1					Frequency: 0...1/ 4/ 8/ 16 kHz	DIP switch		24 V DC	100 V	2-way	Z	Frequency output
2					NPN output, Limit value	Potentiometer		24 V DC			Z	
2					NPN output, Limit value	Potentiometer		24 V DC			Z	
1	X							input loop	100 V	2-way	Z	Passive isolator ILP
1		X						output loop	50 V	2-way	Z	Passive converter OLP
1		X						output loop	50 V	2-way	Z	Passive converter OLP
1		X						output loop	50 V	2-way	Z	Passive converter OLP
1		X						output loop	50 V	2-way	Z	Passive converter OLP
1		X						output loop	50 V	2-way	Z	Passive converter OLP
1		X						output loop	50 V	2-way	Z	Passive converter OLP
1		X						output loop	50 V	2-way	Z	Passive converter OLP
1		X				Potentiometer		output loop	300 V	2-way	S	Passive converter, ATEX approval Zone 2, UL certified
1		X				Potentiometer		output loop	300 V	2-way	P	Passive converter, ATEX approval Zone 2, UL certified

Connection system: S = screw / Z = tension clamp / P = Push In, ILP = Input Loop Powered, OLP = Output Loop Powered

# Quick select – Analogue Signal Conditioning

Selection table

Order No.	Product	Input										Miscellaneous	Sensor feed	Width
		Amount	0...20 mA	4...20 mA	0...10 V	0...5 V	TC	RTD	Frequency					
<b>Signal &amp; serial interface converters – WAVESERIES</b>														
<b>Universal measurement transducers</b>														
8939670000	WAS6 TTA	1	X	X	X	X	X	X	X	X	-200...500 mV, T192-20...50 V, 2 Hz...100 kHz, RTD, TC, resistance, potentiometer	X	45 mm	
8939680000	WAZ6 TTA	1	X	X	X	X	X	X	X	X	-200...500 mV, T192-20...50 V, 2 Hz...100 kHz, RTD, TC, resistance, potentiometer	X	45 mm	
8964310000	WAS6 TTA EX	1	X	X	X	X	X	X	X	X	-200...500 mV, T192-20...50 V, 2 Hz...100 kHz, RTD, TC, resistance, potentiometer	X	45 mm	
8964320000	WAZ6 TTA EX	1	X	X	X	X	X	X	X	X	-200...500 mV, T192-20...50 V, 2 Hz...100 kHz, RTD, TC, resistance, potentiometer	X	45 mm	
<b>Current measuring transducers</b>														
8528650000	WAS1 CMA LP 1/5/10A ac	1									0...1/5/10 A AC		22.5 mm	
8528660000	WAZ1 CMA LP 1/5/10A ac	1									0...1/5/10 A AC		22.5 mm	
8975590000	WAS1 CMA LP 1/5/10A EX	1									0...1/5/10 A AC		22.5 mm	
<b>Serial interface converters</b>														
8615700000	WDS2 RS232/RS485/422	1									RS232/RS485/422		22.5 mm	
8615690000	WDS2 RS232/TTY	1									RS232/TTY		22.5 mm	
<b>Limit &amp; current monitoring</b>														
8543820000	WAS5 DC/Alarm	1	X	X	X						4-wire sensor		17.5 mm	
8543880000	WAZ5 DC/Alarm	1	X	X	X						4-wire sensor		17.5 mm	
8742610000	PAS CMR 0,5...2,5 A DC										Input range 7.5 A		15.3 mm	
8742620000	PAS CMR 2,0...5,0 A DC										Input range 15 A		15.3 mm	
8742630000	PAS CMR 4,5...10 A DC										Input range 30 A		15.3 mm	
<b>Process value displays</b>														
7940012323	PTX800D RO/AO	1									NAMUR, PNP/NPN, TTL-Logic, 0...10 Hz		97 mm	
7940011133	PTX800D	1									NAMUR, PNP/NPN, TTL-Logic, 0...10 Hz		97 mm	
7940014374	PTX800A 4-20MA/RO/AO	1									-24...+24 mA / -11...+11 V		97 mm	
7940010243	PTX800A 4-20MA	1									-24...+24 mA / -11...+11 V		97 mm	
7940018957	PMX420PLUS	1	X	X	X	X							97 mm	
7940018956	PMX420	1	X	X	X	X			0				97 mm	
7940011979	PMX400HZX RO/AO	1						0		X	NAMUR, PNP/NPN, TTL-Logic		97 mm	
7940015595	PMX400HZX	1								X	NAMUR, PNP/NPN, TTL-Logic		97 mm	
7940011570	DI350 0-10V/0-100.0	1			X								97 mm	
7940010185	DI350 4-20MA/0-100.0	1		X									97 mm	
7940010236	LPD450F 4-20MA	1		X									140 mm	
7940010163	LPD350 4-20MA/0-100.0	1		X									97 mm	
<b>Accessories</b>														
8965500000	ACT20-FEED-IN-PRO-S	1									24 V + 24 V redundancy		22.5 mm	
2456870000	ACT20-FEED-IN-PRO-P	1									24 V + 24 V redundancy		22.5 mm	
1282490000	ACT20-FEED-IN-BASIC-S	1									24 V		6.1 mm	
8978580000	CBX200 USB	1									Chinch plug			

Amount	Output					Configuration	Auxiliary power	Rated voltage	Isolation	Connection system	Special characteristics
	0...20 mA	4...20 mA	0...10 V	Relay	Miscellaneous						
3	X	X	X	X	1 x analogue output + 2 x Limit value relay output	Software	18 V - 230 V AC/DC	300 V	3-way	S	
3	X	X	X	X	1 x analogue output + 2 x Limit value relay output	Software	18 V - 230 V AC/DC	300 V	3-way	Z	
3	X	X	X	X	1 x analogue output + 2 x Limit value relay output	Software	18 V - 230 V AC/DC	300 V	3-way	S	ATEX approval Zone 2
3	X	X	X	X	1 x analogue output + 2 x Limit value relay output	Software	18 V - 230 V AC/DC	300 V	2-way	Z	ATEX approval Zone 2
1		X				DIP switch	output loop	300 V	2-way	S	
1		X				DIP switch	output loop	300 V	2-way	Z	
1		X				DIP switch	output loop	300 V	2-way	S	ATEX approval Zone 2
1					RS232/RS485/422	DIP switch	24 V DC		3-way	S	
1					RS232/TTY	DIP switch	24 V DC		3-way	S	
2				X	2 x Limit value relay output	DIP switch, potentiometer	24 V DC	300 V	3-way	S	
2				X	2 x Limit value relay output	DIP switch, potentiometer	24 V DC	300 V	3-way	Z	
1				X	Reed contact activated from 0.5 A DC	-	-	-	2-way	S	
1				X	Reed contact activated from 2 A DC	-	-	-	2-way	S	
1				X	Reed contact activated from 4,5 A DC	-	-	-	2-way	S	
1	X	X	X	X	Display with 8 Digits	Buttons on the device	24 V DC	300 V	3-way	S	
1				X	Display with 8 Digits	Buttons on the device	24 V DC	300 V	3-way	S	
1	X	X	X	X	Display with 8 Digits	Buttons on the device	24 V DC	300 V	3-way	S	
1				X	Display with 8 Digits	Buttons on the device	24 V DC	300 V	3-way	S	
				X	4 x Relays, Display with 4 Digits	Buttons on the device	24 V DC	300 V	3-way	S	
					Display with 4 Digits	Buttons on the device	18...50 V DC	300 V	3-way	S	
1	X	X	X	X	2 x Relays, Display with 4 Digits	Buttons on the device	24 V DC	300 V	3-way	S	
1				X	2 x Relays, Display with 4 Digits	Buttons on the device	24 V DC	300 V	3-way	S	
					Display with 4,5 Digits 0...100%	Buttons on the device	24 V DC	300 V	3-way	S	
					Display with 4,5 Digits 0...100%	Buttons on the device	24 V DC	300 V	3-way	S	
					Display with 4,5 Digits 0...100%	Buttons on the device	loop powered			S	
					Display with 4,5 Digits 0...100%	Buttons on the device	loop powered			S	
1				X	24 V for CH20M bus systems + redundancy		24 V DC			S	
1				X	24 V for CH20M bus systems + redundancy		24 V DC			P	
1					24 V for CH20M bus systems		24 V DC			S	
1						Software	-			RJ45	Interface adapter for configuration

Connection system: S = screw / Z = tension clamp / P = Push In, ILP = Input Loop Powered, OLP = Output Loop Powered





# Simple and retrofittable – IoT-terminal

<b>Simple and retrofittable – IoT-terminal</b>	Introduction	A.2
	IoT-terminal	A.4

# Lay the foundations for generating added value from data

## Industrial IoT - simple and compact with the IoT-terminal

The IoT-terminal enables the monitoring of physically separated systems with IoT solutions. It also makes it easier to retrofit industrial IoT on existing systems. But the Weidmüller IoT-terminal also offers a cost-effective solution for integrating all system components into the automation system.

The IoT-terminal is an open, secure and quickly integrated solution for industrial IoT. It captures data, transfers data to cloud services while also allowing for active data-driven interactions. The Weidmüller IoT-terminal is based on proven IT technologies in a cost-optimised design. It also makes it easier to retrofit industrial IoT on existing systems.

### Your particular benefits for IoT:

- Retrofit solution
- Narrow and compact tree design
- Cloud integration via MQTT
- Mobile communication with NB-IoT and LTE-M Cat. 1
- Suitable for various applications



**Mobile communication**

The data is communicated via NB-IoT and LTE-M Cat.1 mobile radio. These are 3GPP telecommunications standards that are optimised for cost-effective, energy-saving, low-rate and high-density IoT services.



**BLE Interface for Smartphones**

An intuitive smartphone app supports the user during the entire setup and maintenance process.

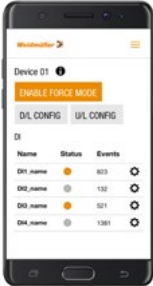

**Cloud integration**

Communication to the Weidmüller cloud platform is performed via MQTT.

**IoT-terminal****IoT-terminal**

- Retrofitting of Industrial IoT for existing systems
- Proven IT technologies, cost-optimal design
- Monitoring of spatially-separated systems with IoT solutions
- Integration of all system parts in automation
- Optimised for a wide range of industrial applications

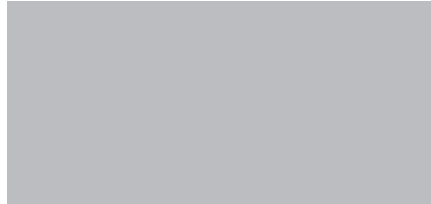
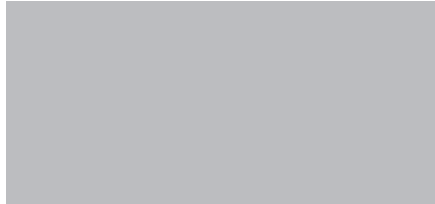
**IT20-ATDIORO-NB-P****Technical data**

Supply	
Supply voltage at DC, min.	9.6 V
Supply voltage at DC, max.	31.2 V
Communication	
Wireless module	Cat-M1, Cat-NB1, EDGE, GPRS
SIM-Card slot type	NANO-SIM
Input	
Number of channels analogue input - RTD	4
Sensor connection analogue input - RTD	2-wire, 3-wire, 4-wire
Type analogue input - RTD	Pt100, Pt200, Pt500, Pt1000, Ni100, Ni120, Ni 200, Ni500, Ni1000, Cu10, 40Ω, 80Ω, 150Ω, 300Ω, 500Ω, 1kΩ, 2kΩ, 4kΩ
Number of channels analogue input - TC	4
Sensor connection analogue input - TC	2-wire
Type analogue input - TC	J, K, T, B, N, E, R, S, L, U, mV
Number of channels analogue input - V   mA	2
Sensor connection analogue input - V   mA	2-wire
Resolution analogue input voltage - V   mA	16 Bit
Number of channels digital input	4
Sensor connection digital input	2-wire
Input delay adjustable	0s...40s
RS-485 2-wire	Data+, Data-, GND
Output	
Number of channels digital output	4
Type	P-switching
Number of channels relay output	2

**Note**

**Ordering data**

Type	Qty.	Order No.
IT20-ATDIORO-NB-P		2740080000

**Note**

**Accessories**

**Note**

# Network-compatible current measuring transducers – ACT20C

---

<b>Network-compatible current measuring transducers – ACT20C</b>	Introduction	B.2
	Selection table	B.4
	ACT20C Gateway	B.6
	Network-compatible current measuring transducers – ACT20C	B.7

---

# ACT20C signal conditioner with Ethernet interface

Comprehensive process transparency is provided by the transfer of diagnostics information, signals and data

**B**

To be able to control systems and processes optimally, you require a constant flow of information on the current states of individual applications, devices and functions.

Our ACT20C signal conditioner not only monitors the signal conversion, but also communicates precise information on device status, signals and data directly to connected computer and control systems.

Our Ethernet interface enables an event-controlled transfer of diagnostics information, which in turn supports the elimination of faults in, for example, plant operation.



**Universal signal conversion**

Can be used in a multitude of applications thanks to customer and application specific defined conversion methods with just one single module.

**Simple operation and configuration**

Software supported configuration allows a fast application of settings and simple operation.

**Simple remote access**

Continuous monitoring of device and system functions, simple and affordable integration of existing Ethernet networks.

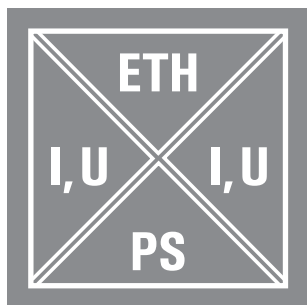

**Condition monitoring**

Preventative maintenance strategies using automation-independent information about operating conditions and process data for connected devices.

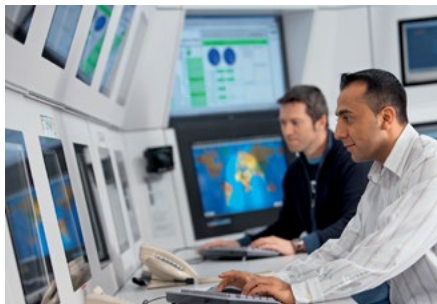

**Multiple limit value monitoring**

The main alarm and auxiliary alarm permit precise identification of all alarm situations.

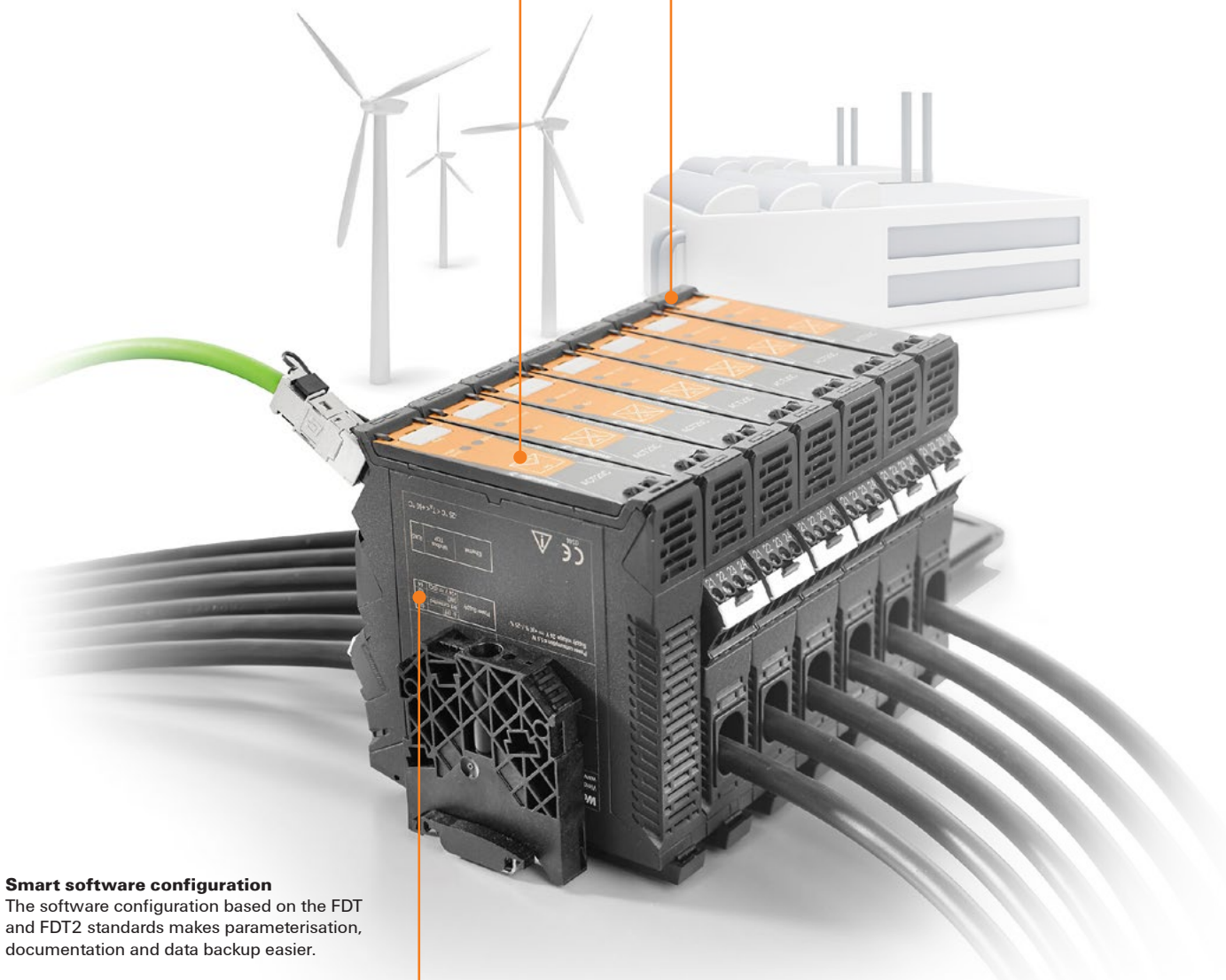
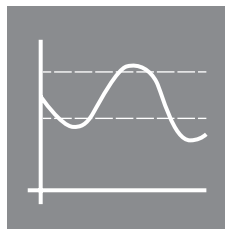

**Smart software configuration**

The software configuration based on the FDT and FDT2 standards makes parameterisation, documentation and data backup easier.



**High process reliability**

A galvanic four-way isolation and an impulse withstand voltage of 6.4 kV pursuant to IEC 61010-2-201 guarantee optimum fusing.

# Selection table

**B**

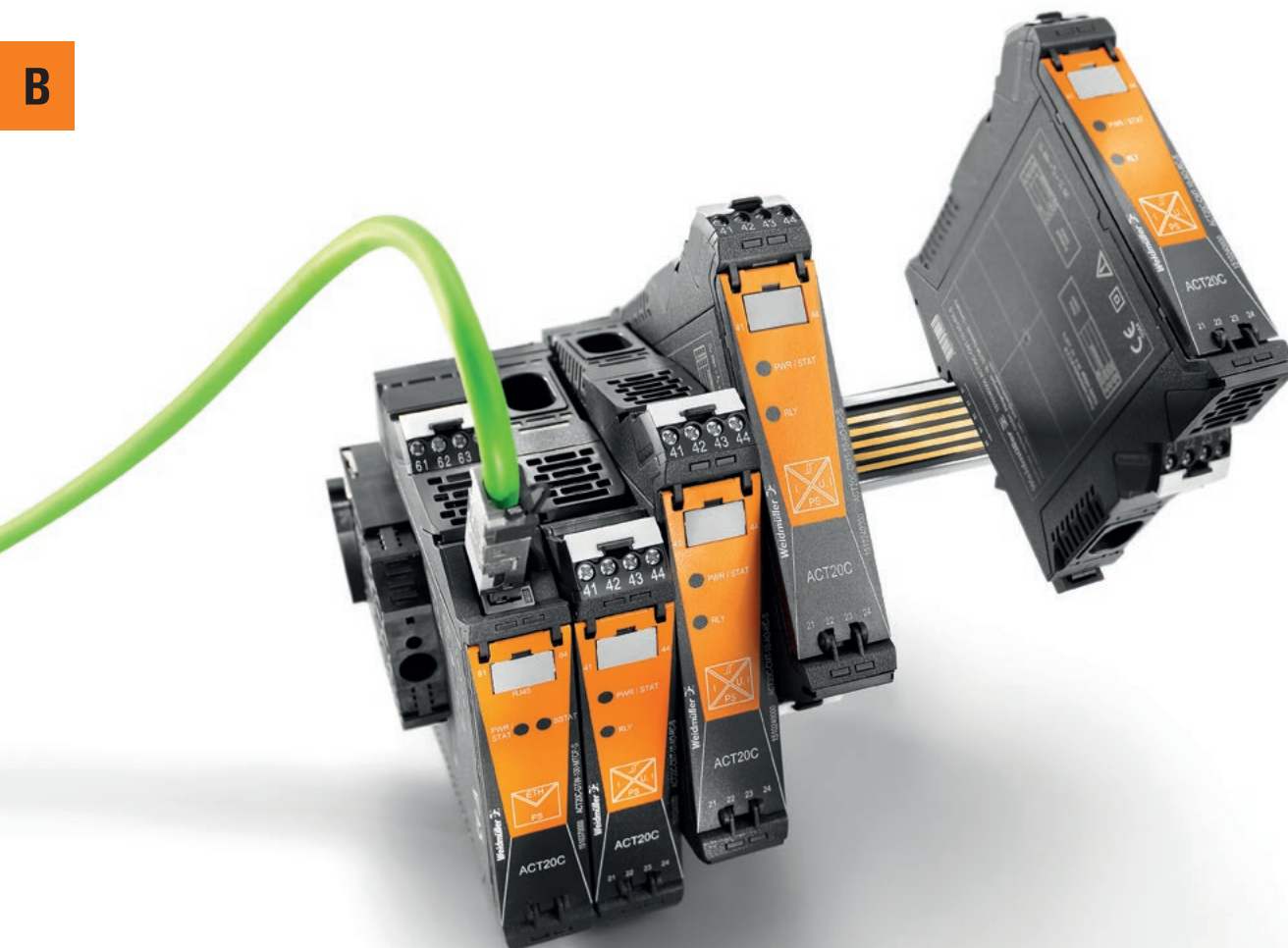

## Selection table

Order No.	Product	Input							Miscellaneous	Sensor feed	Width
		Amount	0...20 mA	4...20 mA	0...10 V	0...5 V	TC	RTD			
<b>Network-compatible current measuring transducers – ACT20C</b>											
1510370000	ACT20C-GTW-100-MTCP-S	1							RJ45, Modbus TCP		22.5 mm
1510240000	ACT20C-CMT-10-AQ-RC-S	1							0...5/10 A AC/DC		22.5 mm
1510420000	ACT20C-CMT-60-AQ-RC-S	1							0...40/50/60 A AC/DC		22.5 mm
2044840000	ACT20C-CML-10-AQ-RC-S	1							0...1/5/10 A AC/DC		22.5 mm
1510340000	ACT20C-LBT-10	0									20.6 mm



	Output					Configuration	Auxiliary power	Rated voltage	Isolation	Connection system	Special characteristics
	Amount	0...20 mA	4...20 mA	0...10 V	Relay						
0						Software	24 V DC	30 V	3-way	S	Modbus TCP Gateway
1	X	X	X	X	X	± 20 mA, Limit value relays	24 V DC	300 V	4-way	S	Through hole current converter
1	X	X	X	X	X	± 20 mA, Limit value relays	24 V DC	300 V	4-way	S	Through hole current converter
1	X	X	X	X	X	± 20 mA, Limit value relays	24 V DC	300 V	4-way	S	Current carrying conductor at the terminals
0											Electrical termination on mounting rail bus, ACT20C station

Connection system: S = screw / Z = tension clamp / P = Push In, ILP = Input Loop Powered, OLP = Output Loop Powered

## ACT20C Gateway

### Gateway for ACT20C station

- Access to all data from the devices connected to an ACT20C station
- RJ45 port with Ethernet TCP/IP
- Configuration by means of the FDT/DTM standard
- Station management with "Plug & Produce" and "Hot Swapping"

### ACT20C-GTW-100-MTCP-S

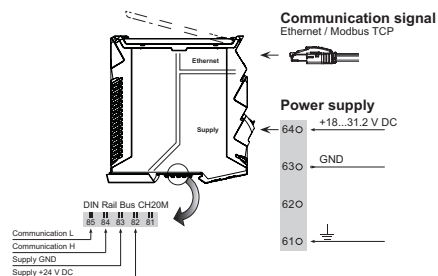
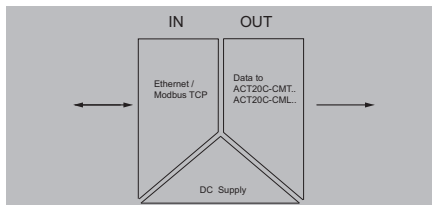

### Technical data

Communication	
Addressing	
Configuration	
RJ45 ports	
Interface	
General data	
Configuration	
Power consumption, max.	
Voltage supply	
Insulation coordination	
Rated voltage / test voltage: Ethernet interface to supply / functional earth to supply / Ethernet interface	
Standards	
Test voltage	
Impulse withstand voltage	
Pollution degree	
Overtoltage category	

DHCP or manual adjustment	
With FDT/DTM software, DHCP	
10/100BaseT(X), auto negotiation	
Ethernet 10/100 Base T, Jack plug for CBX200, Communication via CH20M rail bus with all current measuring transducers (ACT20C-CMT-x)	
General data	
With FDT/DTM software, DHCP	
1.5 W	
18.0 ... 31.2 V DC	
Insulation coordination	
30 V AC RMS	
IEC 61010-1, IEC 61010-2-201:2013, 1st Edition, IEC 61326-1:2012	
1.1 kV	
0,5 kV (1.2/50 µs)	
2	
II	

Dimensions	
Clamping range (nominal / min. / max.)	mm <sup>2</sup>
Depth / Height / Width	
Note	

Screw connection, RJ45 plug-in connector	
1.5 / 0.5 / 2.5	
113.6 / 117.2 / 22.5	
Note	

### Ordering data

Type	Qty.	Order No.
ACT20C-GTW-100-MTCP-S	1	1510370000
Note		

Type	Qty.	Order No.
ACT20C-GTW-100-MTCP-S	1	1510370000
Note		

### Accessories

Note

Note

Note

**Communicative current-measuring transducer**

- Measuring and monitoring of AC/DC current
- Input and output ranges are adjustable
- Contact-free through-hole technology
- Relay output for limit value alarm with switching threshold, delay, hysteresis
- Monitoring/configuration via ACT20C station/gateway

**ACT20C-CMT**

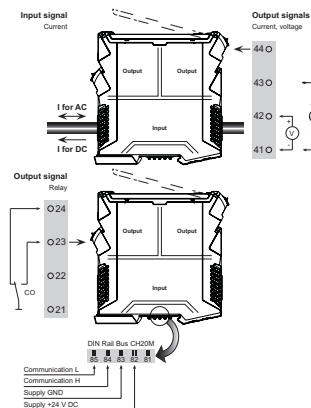
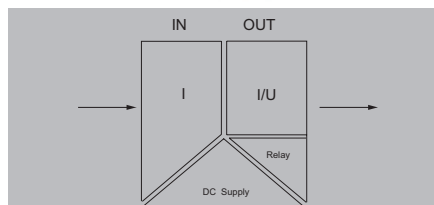

**Technical data**

<b>Input</b>	
Input measurement range	
Input signal	
Input frequency	
<b>Output (analogue)</b>	
Output voltage	
Output current	
Load resistance current	
Load resistance voltage	
<b>Output (digital)</b>	
Type	
Rated switching current	
Max. switching voltage, AC	
<b>General data</b>	
Configuration	
Step response time	
Temperature coefficient	
Voltage supply	
<b>Insulation coordination</b>	
Rated voltage	
EMC standards	
Galvanic isolation	
Test voltage	
Impulse withstand voltage	
Pollution degree	
Overvoltage category	
<b>Dimensions</b>	
Clamping range (nominal / min. / max.)	mm <sup>2</sup>
Depth / Height / Width	
<b>Note</b>	

1510240000: configurable, 0...5/10 A AC (RMS) or DC; 1510420000: configurable, 0...40/50/60 A AC (RMS) or DC	
Current-carrying cable in feed-through hole, Diameter 10.5 mm AC: 15...700 Hz	
Adjustable, 0...10 V, 2...10 V, 0...5 V, 1...5 V, -5...+5 V, -10...+10 V	
Adjustable, 0...20 mA, 4...20 mA, -20...+20 mA	
≤ 600 Ω	
≥ 10 kΩ	
Relay, 1 CO contact, Process alarms (4x) with hysteresis, with alarm delay (configurable) 0...180 s	
6 A	
250 V	
With FDT/DTM software, via gateway (ACT20C-GTW-100-MTCP-S), Addressing via DIP switches	
< 300 ms	
typ. 0.04 % / K, max. 0.09 % / K	
via the system bus	
300 V AC <sub>rms</sub>	
IEC 61326-1	
4-way isolator, between input/output/supply/relay	
4 kV	
6.4 kV (1.2/50 μs)	
2	
III	
<b>Screw connection</b>	
1.5 / 0.5 / 2.5	
113.6 / 117.2 / 22.5	

**Ordering data**

Input measurement range 0...5/10 A
Input measurement range 0...40/50/60 A
<b>Note</b>

Type	Qty.	Order No.
ACT20C-CMT-10-AD-RC-S	1	1510240000
ACT20C-CMT-60-AD-RC-S	1	1510420000

**Accessories**

<b>Note</b>
-------------

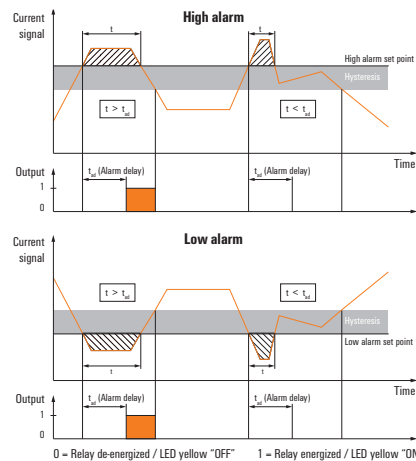

0 = Relay de-energized / LED yellow "OFF" 1 = Relay energized / LED yellow "ON"

User address	DIP switch S1					
	1	2	3	4	5	6
2		■				
3	■	■				
4			■			
5	■					
6		■	■			
7	■	■	■			
8				■		
...						
16					■	
...						
32						■
33	■					■

■ = ON

## Network-compatible current measuring transducers – ACT20C

### Communicative current-measuring transducer

- Measurement and monitoring of AC/DC currents
- Input/output electrically isolated
- Measurement range extension via passive current transformers
- A component of the ACT20C station
- Relay output for limit value alarm with switching threshold, delay, hysteresis

### ACT20C-CML-10-A0-RC-S

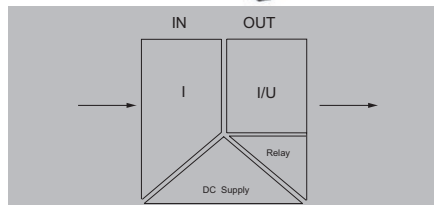

#### Technical data

<b>Input</b>	
Input measurement range	configurable, 0...1/5/10 A AC (RMS) or DC
Input signal	Power cable can be connected to the terminals
Input frequency	AC: 15...400 Hz (true root mean square), AC: 50 Hz (arithmetic average)
<b>Output (analogue)</b>	
Output voltage	Adjustable, 0...10 V, 2...10 V, 0...5 V, 1...5 V, -5...+5 V, -10...+10 V
Output current	Adjustable, 0...20 mA, 4...20 mA, -20...+20 mA
Load resistance current	≤ 600 Ω
Load resistance voltage	≥ 10 kΩ
<b>Output (digital)</b>	
Type	Relay, 1 CO contact, Process alarms (4x) with hysteresis, with alarm delay (configurable) 0...180 s
Rated switching current	2 A
Max. switching voltage, AC	250 V
<b>General data</b>	
Configuration	for thresholds (overcurrent / undercurrent), delay and hysteresis, via gateway (ACT20C-GTW-100-MTCP-S), With FDT/DTM software
Step response time	≤ 300 ms (RMS), ≤ 60 ms (AA)
Temperature coefficient	≤ ±100 ppm/K @ -25...+55 °C, ≤ ±200 ppm/K @ +55...+70 °C
Voltage supply	24 V DC ± 30 %
<b>Insulation coordination</b>	
Rated voltage	300 V AC <sub>rms</sub>
EMC standards	IEC 61326-1, IEC 61010-2-201
Galvanic isolation	4-way isolator, between input/output/supply/relay
Test voltage	4 kV
Impulse withstand voltage	6 kV (1.2/50 μs)
Pollution degree	2
Overvoltage category	III
<b>Dimensions</b>	
Clamping range (nominal / min. / max.)	1.5 / 0.5 / 2.5 mm <sup>2</sup>
Depth / Height / Width	113.6 / 117.2 / 17.5
<b>Note</b>	

#### Ordering data

<b>Type</b>	<b>Qty.</b>	<b>Order No.</b>
ACT20C-CML-10-A0-RC-S	1	2044840000
<b>Note</b>		

#### Accessories

<b>Note</b>	
-------------	--

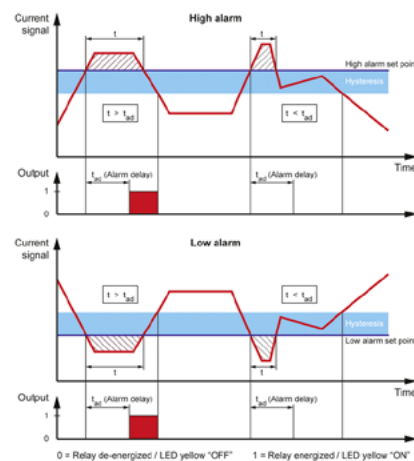
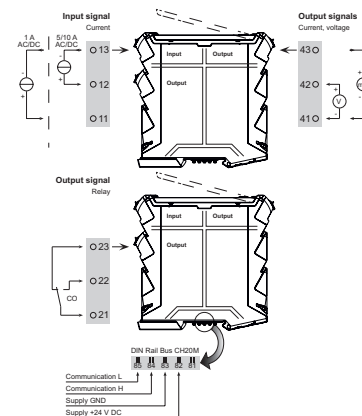

#### Configuration

User address	DIP switch S1					
	1	2	3	4	5	6
2						
3						
4						
5						
6						
7						
8						
...						
16						
...						
32						
33						

■ = ON

### Bus termination terminal

- Electrical termination of the CH20M rail bus of an ACT20C station
- Acts as a mechanical end bracket at the same time

### ACT20C-LBT-10



### Technical data

Humidity  
Ambient temperature

5...95 %, no condensation  
-25 °C...+60 °C

#### General data

Tightening torque, min.  
Tightening torque, max.  
Rail

1.2 Nm  
2.4 Nm  
TS 35

### Dimensions

Depth / Width / Height

63 / 20.6 / 56

### Note

### Ordering data

Type	Qty.	Order No.
ACT20C-LBT-10	1	1510340000

### Note

### Accessories

#### Note



# Intrinsically safe signal converters – ACT20X

<b>Intrinsically safe signal converters – ACT20X</b>	Introduction	C.2
	Selection table	C.4
	HART® transparent supply isolator	C.6
	HART® transparent output driver	C.8
	Temperature transducer	C.10
	Pulse isolators with relay output	C.12
	Pulse isolators with transistor output	C.14
	Digital output	C.16
	Universal measurement transducers	C.20

# Secure isolation of signals from hazardous areas

## Intrinsically safe ACT20X Ex-signal converters

**C** Your application requires signals to be routed to or from hazardous areas. Our intrinsically safe ACT20X signal isolating converters meet the strict standards of the process industry and process signals from a wide range of Ex-zones (Zones 0, 1, 2) for control purposes.

ACT20X can be used universally. On the input side, the converter can process HART® input signals, or DC, RTD, thermocouple or NAMUR signals from the Ex-zone. On the output side, the ACT20X controls field devices with analogue or digital signals. All ACT20X products are characterised by high insulation, high accuracy and high temperature stability.

The 2-channel versions with width of 22.5 mm are available with either transistor or relay output. Because of this highly integrated design, the ACT20X helps you to reduce installation costs and use less space.

Intrinsically safe signal converters with SIL approval are available for safety functions, e.g. switching aggregates on/off, monitoring actuators or temperature/pressure. Our ACT20X complies with these stringent standards of the process industry, as well as mining industry requirements.







### Configuration via FDT

All modules can be quickly and conveniently configured with manufacturer-independent FDT/DTM software.

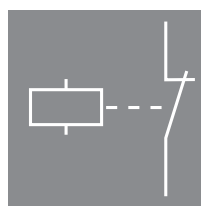

### Alarm function

No laborious troubleshooting. Alarm function integrated for cable or sensor errors. In case of failures, a diagnostic signal is sent to the control system.



### Worldwide application

Fulfills the strict standards and requirements of the process industry. Can be used worldwide due to international and local approvals ATEX, IECEx, CULUS, FM, GOST and DNV.

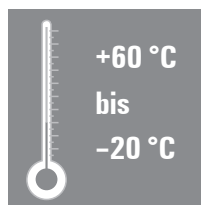

### Robust

Wide ambient temperature range from - 20 °C ... + 60 °C.



### Intelligent connection system

Pluggable, coded, with release lever. The release lever simplifies maintenance and allows disconnection without damaging the cables.



### SIL certification according 61508

Available for safety functions, e.g. switching aggregates on/off, monitoring actuators or temperature/pressure.

# Selection table



## Selection table

Order No.	Product	Input								Miscellaneous	Sensor feed	Width
		Amount	0...20 mA	4...20 mA	0...10 V	0...5 V	TC	RTD	Frequency			
<b>Intrinsically safe signal converters - ACT20X</b>												
<b>HART® transparent supply isolator</b>												
8965430000	ACT20X-HAI-SAO-S	1	X	X						EX, HART® transparent	X	22.5 mm
2456140000	ACT20X-HAI-SAO-P	1	X	X						EX, HART® transparent	X	22.5 mm
8965440000	ACT20X-2HAI-2SAO-S	2	X	X						EX, HART® transparent	X	22.5 mm
2456150000	ACT20X-2HAI-2SAO-P	2	X	X						EX, HART® transparent	X	22.5 mm
<b>HART® transparent output driver</b>												
8965450000	ACT20X-SAI-HAO-S	1		X						HART® transparent		22.5 mm
2456160000	ACT20X-SAI-HAO-P	1		X						HART® transparent		22.5 mm
8965460000	ACT20X-2SAI-2HAO-S	2		X						HART® transparent		22.5 mm
2456170000	ACT20X-2SAI-2HAO-P	2		X						HART® transparent		22.5 mm
<b>Temperature transducer</b>												
8965470000	ACT20X-HTI-SAO-S	1	X	X			X	X		EX, temperature + mA		22.5 mm
2456180000	ACT20X-HTI-SAO-P	1	X	X			X	X		EX, temperature + mA		22.5 mm
8965480000	ACT20X-2HTI-2SAO-S	2	X	X			X	X		EX, temperature + mA		22.5 mm
2456190000	ACT20X-2HTI-2SAO-P	2	X	X			X	X		EX, temperature + mA		22.5 mm
<b>Pulse isolators with relay output</b>												
8965340000	ACT20X-HDI-SDO-RNO-S	1								EX, Namur initiator, switching signal	X	22.5 mm
2456050000	ACT20X-HDI-SDO-RNO-P	1								EX, Namur initiator, switching signal	X	22.5 mm
8965350000	ACT20X-HDI-SDO-RNC-S	1								EX, Namur initiator, switching signal	X	22.5 mm
2456060000	ACT20X-HDI-SDO-RNC-P	1								EX, Namur initiator, switching signal	X	22.5 mm
8965370000	ACT20X-2HDI-2SDO-RNO-S	2								EX, Namur initiator, switching signal	X	22.5 mm
2456080000	ACT20X-2HDI-2SDO-RNO-P	2								EX, Namur initiator, switching signal	X	22.5 mm
8965380000	ACT20X-2HDI-2SDO-RNC-S	2								EX, Namur initiator, switching signal	X	22.5 mm
2456090000	ACT20X-2HDI-2SDO-RNC-P	2								EX, Namur initiator, switching signal	X	22.5 mm
<b>Pulse isolators with transistor output</b>												
8965360000	ACT20X-HDI-SDO-S	1								EX, Namur initiator, switching signal	X	22.5 mm
2456070000	ACT20X-HDI-SDO-P	1								EX, Namur initiator, switching signal	X	22.5 mm
8965390000	ACT20X-2HDI-2SDO-S	2								EX, Namur initiator, switching signal	X	22.5 mm
2456100000	ACT20X-2HDI-2SDO-P	2								EX, Namur initiator, switching signal	X	22.5 mm
<b>Digital output</b>												
8965400000	ACT20X-SDI-HDO-L-S	1								NPN / PNP switching signal		22.5 mm
2456100000	ACT20X-SDI-HDO-L-P	1								NPN / PNP switching signal		22.5 mm
8965420000	ACT20X-2SDI-2HDO-S	2								NPN / PNP switching signal		22.5 mm
2456120000	ACT20X-2SDI-2HDO-P	2								NPN / PNP switching signal		22.5 mm
8965410000	ACT20X-SDI-HDO-H-S	1								NPN / PNP switching signal		22.5 mm
2456120000	ACT20X-SDI-HDO-H-P	1								NPN / PNP switching signal		22.5 mm
<b>Universal measurement transducers</b>												
8965490000	ACT20X-HUI-SAO-S	1	X	X	X	X	X	X		EX, temperature + mA + V	X	22.5 mm
2456200000	ACT20X-HUI-SAO-P	1	X	X	X	X	X	X		EX, temperature + mA + V	X	22.5 mm
1318220000	ACT20X-HUI-SAO-LP-S	1	X	X	X	X	X	X		EX, temperature + mA + V		12.5 mm

Amount	Output				Relay	Miscellaneous	Configuration	Auxiliary power	Rated voltage	Isolation	Connection system	Special characteristics
	0...20 mA	4...20 mA	0...10 V									
1		X				Status relay	Software	24 V DC	300 V	3-way	S	With ATEX approval, intrinsic safety, HART <sup>®</sup> transparent
1		X				Status relay	Software	24 V DC	300 V	3-way	P	With ATEX approval, intrinsic safety, HART <sup>®</sup> transparent
2		X				Status relay	Software	24 V DC	300 V	3-way	S	With ATEX approval, intrinsic safety, HART <sup>®</sup> transparent
2		X				Status relay	Software	24 V DC	300 V	3-way	P	With ATEX approval, intrinsic safety, HART <sup>®</sup> transparent
1		X				Ex Output, Status relay	Software	24 V DC	300 V	3-way	S	With ATEX approval, intrinsic safety, HART <sup>®</sup> transparent
1		X				Ex Output, Status relay	Software	24 V DC	300 V	3-way	P	With ATEX approval, intrinsic safety, HART <sup>®</sup> transparent
2		X				Ex Output, Status relay	Software	24 V DC	300 V	3-way	S	With ATEX approval, intrinsic safety, HART <sup>®</sup> transparent
2		X				Ex Output, Status relay	Software	24 V DC	300 V	3-way	P	With ATEX approval, intrinsic safety, HART <sup>®</sup> transparent
1	X	X				Status relay	Software	24 V DC	300 V	3-way	S	With ATEX approval, intrinsic safety
1	X	X				Status relay	Software	24 V DC	300 V	3-way	P	With ATEX approval, intrinsic safety
2	X	X				Status relay	Software	24 V DC	300 V	3-way	S	With ATEX approval, intrinsic safety
2	X	X				Status relay	Software	24 V DC	300 V	3-way	P	With ATEX approval, intrinsic safety
1				X		Relay output, Status relay	Software	24 V DC	300 V	3-way	S	With ATEX approval, intrinsic safety
1				X		Relay output, Status relay	Software	24 V DC	300 V	3-way	P	With ATEX approval, intrinsic safety
1				X		Relay output, Status relay	Software	24 V DC	300 V	3-way	S	With ATEX approval, intrinsic safety
1				X		Relay output, Status relay	Software	24 V DC	300 V	3-way	P	With ATEX approval, intrinsic safety
2				X		Relay output, Status relay	Software	24 V DC	300 V	3-way	S	With ATEX approval, intrinsic safety
2				X		Relay output, Status relay	Software	24 V DC	300 V	3-way	P	With ATEX approval, intrinsic safety
2				X		Relay output, Status relay	Software	24 V DC	300 V	3-way	S	With ATEX approval, intrinsic safety
2				X		Relay output, Status relay	Software	24 V DC	300 V	3-way	P	With ATEX approval, intrinsic safety
1						Transistor output, Status relay	Software	24 V DC	300 V	3-way	S	With ATEX approval, intrinsic safety
1						Transistor output, Status relay	Software	24 V DC	300 V	3-way	P	With ATEX approval, intrinsic safety
2						Transistor output, Status relay	Software	24 V DC	300 V	3-way	S	With ATEX approval, intrinsic safety
2						Transistor output, Status relay	Software	24 V DC	300 V	3-way	P	With ATEX approval, intrinsic safety
1						Ex Output, Status relay	Software	24 V DC	300 V	3-way	S	With ATEX approval, intrinsic safety
1						Ex Output, Status relay	Software	24 V DC	300 V	3-way	P	With ATEX approval, intrinsic safety
2						Ex Output, Status relay	Software	24 V DC	300 V	3-way	S	ATEX approval, intrinsic safety ignition protection IIC
2						Ex Output, Status relay	Software	24 V DC	300 V	3-way	P	ATEX approval, intrinsic safety ignition protection IIC
1						Ex Output, Status relay	Software	24 V DC	300 V	3-way	S	ATEX approval, intrinsic safety ignition protection IIB
1						Ex Output, Status relay	Software	24 V DC	300 V	3-way	P	ATEX approval, intrinsic safety ignition protection IIB
1	X	X		X		Limit value relay output, Status relay	Software	24 V DC	300 V	3-way	S	With ATEX approval, intrinsic safety
1	X	X		X		Limit value relay output, Status relay	Software	24 V DC	300 V	3-way	P	With ATEX approval, intrinsic safety
1		X				-	Software	output loop	300 V	2-way	S	With ATEX approval, intrinsic safety

Connection system: S = screw / Z = tension clamp / P = Push In, ILP = Input Loop Powered, OLP = Output Loop Powered

## HART® transparent supply isolator

### HART® transparent current supply isolators

The ACT20X-HAI-SAO current supply isolator is a HART®-protocol transparent signal isolator for analogue input signals from Ex zone 0. It provides an analogue signal for the safe zone on the output side. It is available in a single-channel or double-channel version.

EX area Zone 0, 1, 2, 20, 21, 22

Safe area Zone 2 / FM Class 1, Division 2

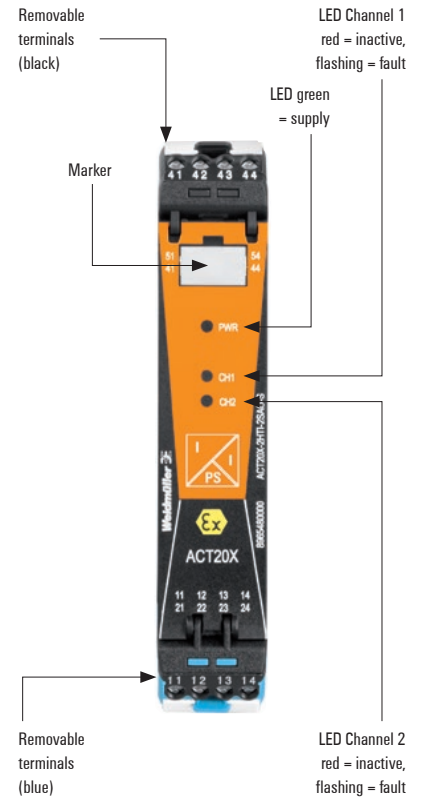
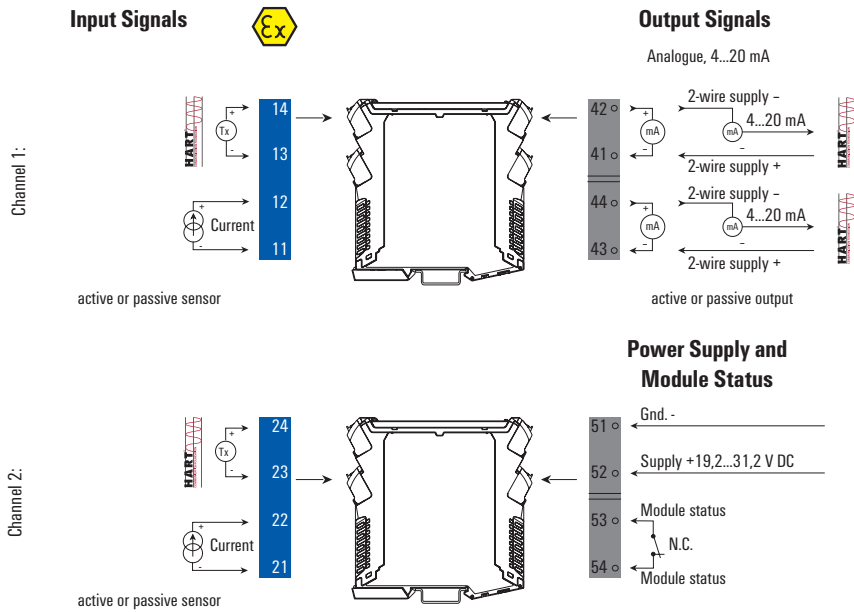

#### Ex label (excerpt)

<b>ATEX</b>	<b>FM</b>	$U_o/U_i$	0 V / 30 V
II 3 G Ex nA nC IIC T4 Gc	Installation in CL I DIV2 GP A-D T4	$I_o/I_i$	0 mA / 120 mA
II (1) G [Ex ia Ga] IIC/IIB/IIA	KI. III ABT 1/2 GP A-G or	$P_o/P_i$	0 mW / 0,85 W
II (1) D [Ex ia Da] IIIC	KI. I Zn2 AEx/Ex nA nC [ia] IIC T4	$L_i$	0 $\mu$ H
	Example:	$C_i$	2 nF
<b>IECEX</b>	ATEX version,	IIC	$C_o = 0,08 \mu$ F, $L_o = 3$ mH
Ex nA nC IIC T4 Gc	Ex input, External Current Source:	IIB	$C_o = 0,6 \mu$ F, $L_o = 12$ mH
[Ex ia Ga] IIC/IIB/IIA	(More details in ATEX certificate)	IIA	$C_o = 2,15 \mu$ F, $L_o = 25$ mH

#### Application example:

#### Measuring temperature with a head transmitter, signal transmission with HART®

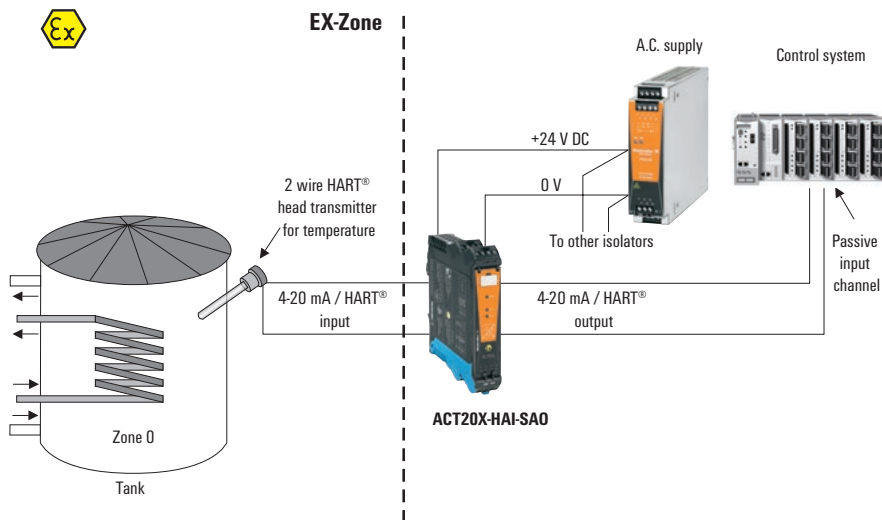

**Current supply isolator**

- Converts analogue signals from Ex zone 0 into analogue output signals for safe zones.
- Active and passive current inputs/outputs
- HART® - transparent
- PC configuration with FDT/DTM software, download at [www.weidmueller.com](http://www.weidmueller.com)
- Relay output for failure alarm
- 2-channel module, can also be used as a signal splitter

**ACT20X-HAI-2SA0-S / 2HAI-2SA0-S**

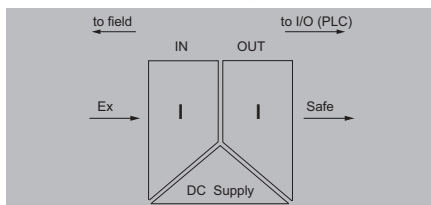

**Technical data**

<b>Input</b>	
Input current	4...20mA
Sensor supply	3.8...26 V DC
Residual ripple (current loop)	< 7.5 mV <sub>eff</sub>
<b>Output analogue</b>	
Output current	4...20 mA
Output signal limit	< 28 mA
Load impedance current	≤ 600 Ω
2-wire supply	≤ 26 V DC
Accuracy	< 0.1% span
Temperature coefficient	< 0.01% of span/°C (TU)
Step response time	≤ 5 ms
Cut-off frequency (-3 dB)	0.5...2.5 kHz @ 3.5...23 mA bi-directional HART® signal
<b>Alarm output</b>	
Type	Relay, 1 NC (voltage-free)
Nominal switching voltage	≤ 125 V AC / 110 V DC (safe area) ≤ 32 V AC / 32 V DC (zone 2)
Continuous current	≤ 0.5 A AC / 0.3 A DC (safe zone), ≤ 0.5 A AC / 1 A DC (zone 2)
Power rating	≤ 62.5 VA / 32 W (safe area) ≤ 16 VA / 32 W (Zone 2)
<b>General data</b>	
Voltage supply	19.2...31.2 V DC
Power consumption	≤ 1.0 W
Ambient temperature / Storage temperature	-20 °C...60 °C / -20 °C...85 °C
<b>Approvals</b>	
Approvals	cULus; DEKRAATEX; DETNORVER; DNVGL; EAC; FMEX; FUSAFETY; IECXDEK
<b>Insulation coordination</b>	
Insulation voltage	2.6 kV (input / output)
Rated voltage	300 V
EMC standards	DIN EN 61326, NE 21
<b>Dimensions</b>	
Clamping range (nominal / min. / max.)	mm <sup>2</sup>
Depth x width x height	mm
<b>Note</b>	
<b>Screw connection</b>	<b>PUSH IN</b>
	2.5 / 0.25 / 2.5
	113.6 / 22.5 / 119.2      114.6 / 22.5 / 127.3
<b>Ordering data</b>	
<b>1-channel version</b>	
	Screw connection
	PUSH IN connection
<b>2-channel version</b>	
	Screw connection
	PUSH IN connection
<b>Note</b>	
	CBX200 USB configuration adapter - 8978580000



## HART® transparent output driver

## HART® transparent current output isolators

The ACT20X-SAI-HAO current output isolator is HART®-transparent. The input is connected to the safe area controller or PLC, and the output is connected to an analog actuator in a hazardous area, e.g. Zone 0. It is available in a single-channel or double-channel version.

### EX area Zone 0, 1, 2, 20, 21, 22

### Safe area Zone 2 / FM Class 1, Division 2

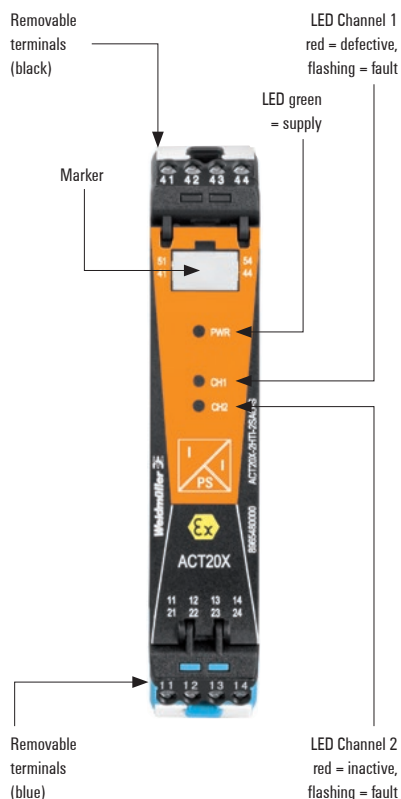
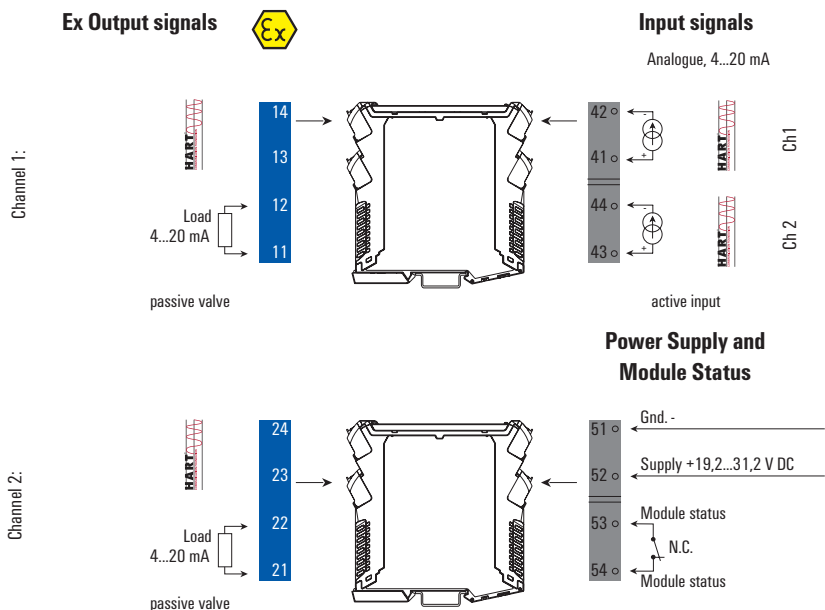

### Ex label (excerpt)

<b>ATEX</b>	<b>FM</b>	$U_o$	28 V
II 3 G Ex nA nC IIC T4 Gc	Installation in CL I DIV2 GP A-D T4	$I_o$	93 mA
II (1) G [Ex ia Ga] IIC/IIB/IIA	KI. III ABT 1/2 GP A-G or	$P_o$	0.65 W
II (1) D [Ex ia Da] IIIC	KI. I Zn2 AEx/Ex nA nC [ia] IIC T4	IIC	$C_o = 0.08 \mu F, L_o = 4 \text{ mH}$
<b>IECEX</b>	Example:	IIB	$C_o = 0.65 \mu F, L_o = 16 \text{ mH}$
Ex nA nC IIC T4 Gc	ATEX version,	IIA	$C_o = 2.15 \mu F, L_o = 32 \text{ mH}$
[Ex ia Ga] IIC/IIB/IIA	Ex output,		
[Ex ia Da] IIIC	(More details in ATEX certificate)		



### Application example: controlling an actuator in the Ex zone.

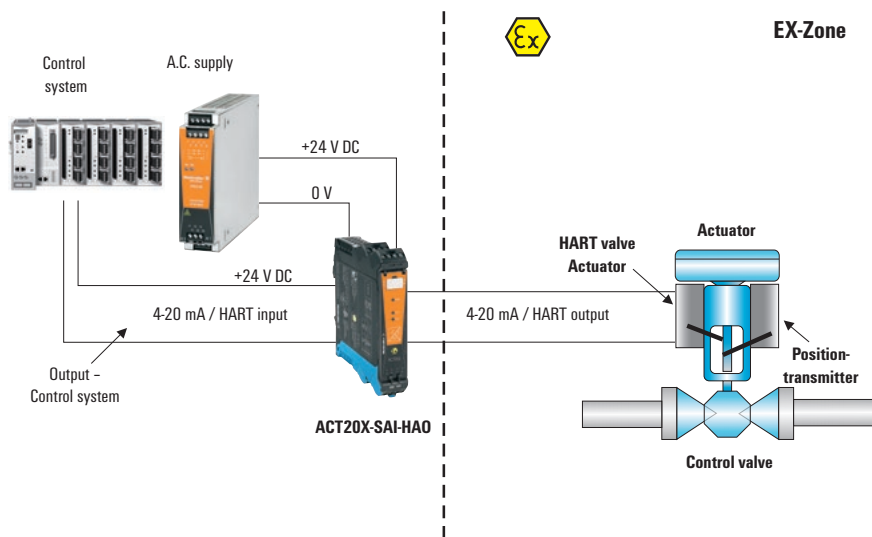

**Current output isolator**

- For controlling field devices located in explosion risk zones
- HART® Transparent
- Relay output for error alarm
- PC configuration with FDT/DTM software, download at [www.weidmueller.com](http://www.weidmueller.com)
- 1 or 2 channels in one module

**ACT20X-SAI-HAO-S / 2SAI-2HAO-S**

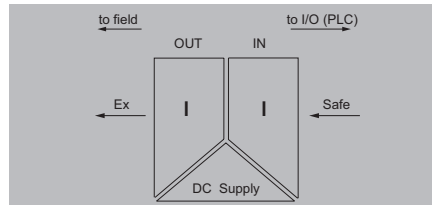

**Technical data**

<b>Input</b>	4...20mA
Input current	4...20mA
Voltage drop	< 2 V
<b>Output analogue</b>	
Output current	4...20 mA (max. 23 mA)
Output signal limit	< 28 mA
Load impedance current	≤ 725 Ω
2-wire supply	> 14.5 V @ 20 mA
Residual ripple (current loop)	< 7.5 mV <sub>eff</sub>
Accuracy	< 0.1% span
Temperature coefficient	< 0.01% of span/°C (TU)
Step response time	≤ 5 ms
Cut-off frequency (-3 dB)	0.5...2.5 kHz @ 3.5...23 mA bi-directional HART® signal
<b>Alarm output</b>	
Type	Relay, 1 NO (voltage-free)
Nominal switching voltage	≤ 125 V AC / 110 V DC (safe area) ≤ 32 V AC / 32 V DC (zone 2)
Continuous current	≤ 0,5 A AC / 1 A DC (zone 2)
Power rating	≤ 62.5 VA / 32 W (safe area) ≤ 16 VA / 32 W (Zone 2)
<b>General data</b>	
Voltage supply	19.2...31.2 V DC
Power consumption	≤ 1.0 W
Ambient temperature / Storage temperature	-20 °C...60 °C / -20 °C...85 °C
<b>Approvals</b>	
Approvals	cULus; DEKRAATEX; DETNORVER; DNVGL; EAC; FMEX; FUSAFETY; IECEXDEK
<b>Insulation coordination</b>	
Insulation voltage	2.6 kV (input / output)
Rated voltage	300 V
EMC standards	DIN EN 61326, NE 21
<b>Dimensions</b>	
Clamping range (nominal / min. / max.)	mm <sup>2</sup>
Depth x width x height	mm
<b>Note</b>	
<b>Screw connection</b>	<b>PUSH IN</b>
	2.5 / 0.25 / 2.5
	113.6 / 22.5 / 119.2      114.6 / 22.5 / 127.3
<b>Ordering data</b>	
<b>1-channel version</b>	
	Screw connection
	PUSH IN connection
<b>2-channel version</b>	
	Screw connection
	PUSH IN connection
<b>Note</b>	CBX200 USB configuration adapter - 8978580000



**Temperature transducer**

**Temperature transducer**

The ACT20X-HTI-SAO temperature transducer processes temperature signals from PT100 sensors and thermocouples originating in the Ex zone. A current signal (mA) can also be connected as the input signal. The input is part of an intrinsically safe circuit (Zone 0). The isolated milliamp analogue output is the input to the receiver or controller in the safe area. It is available in a single-channel or double-channel version.

**EX area Zone 0, 1, 2, 20, 21, 22**

**Safe area Zone 2 / FM Class 1, Division 2**

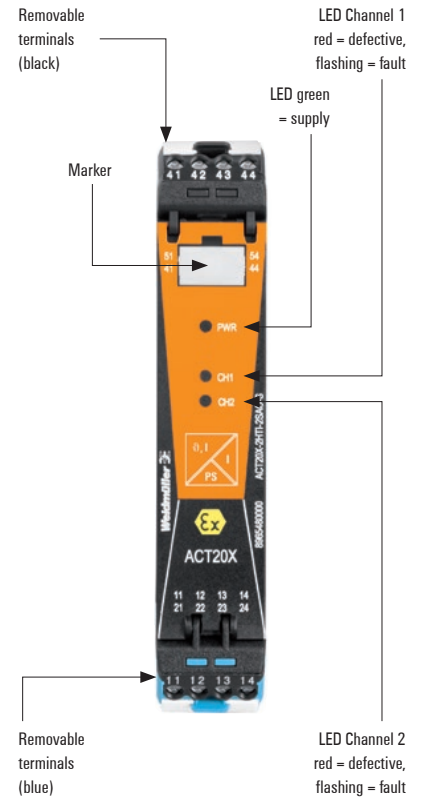
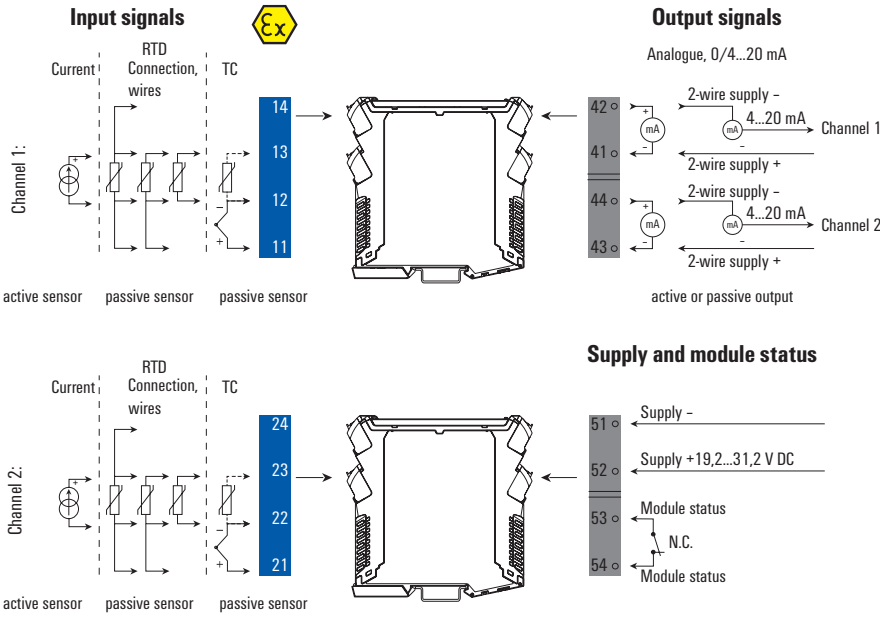

**Ex label (excerpt)**

<b>ATEX</b>	<b>FM</b>	$U_o/U_i$	8.7 V / 10 V
II 3 G Ex nA nC IIC T4	Installation in CL I DIV2 GP A-D T4	$I_o/I_i$	18.4 mA / 30 mA
II (1) G [Ex ia] IIC/IIB/IIA	KI, III ABT 1/2 GP A-G or	$P_o$	400 mW
II (1) D [Ex iaD]	KI, I Zn2 AEx/Ex nA nC [ia] IIC T4	$L_o/R_o/L_i$	892 $\mu$ H/ $\Omega$ / 820 nH
	Example:	$C_i$	30 nF
<b>IECEX</b>	ATEX version,	IIC	$C_o = 5 \mu$ F, $L_o = 100$ mH
Ex nA nC IIC T4 Gc	Ex input Temperature,	IIB	$C_o = 50 \mu$ F, $L_o = 300$ mH
[Ex ia Ga] IIC/IIB/IIA	(More details in ATEX certificate)	IIA	$C_o = 1000 \mu$ F, $L_o = 700$ mH

**Application example: temperature measurements in the Ex zone**

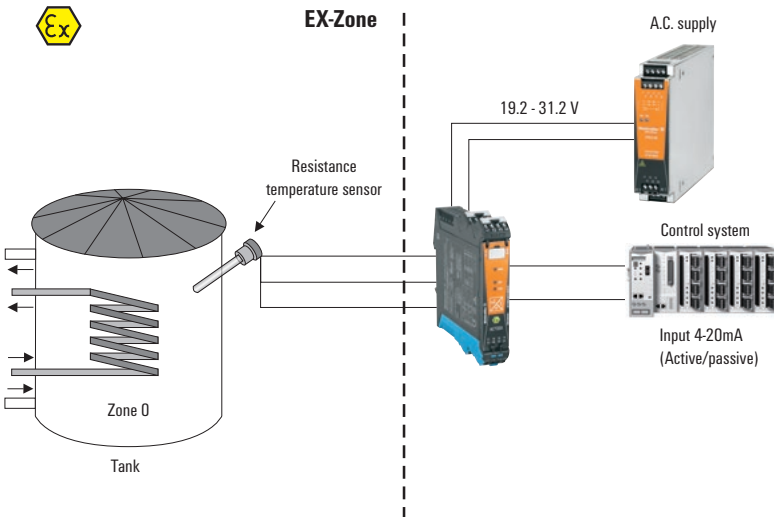

**Accuracy / temperature coefficients  
ACT20X-HTI-SAO**

Input	Accuracy	Temperature coefficient
Input mA	$\leq \pm 4 \mu$ A	$\leq \pm 4 \mu$ A / °C
<b>Input RTD</b>		
Pt100	$\leq \pm 0.2$ °C	$\leq \pm 0.02$ °C / °C
Ni100	$\leq \pm 0.3$ °C	$\leq \pm 0.03$ °C / °C
<b>Input TC</b>		
Type B	$\leq \pm 4.5$ °C	$\leq \pm 0.45$ °C / °C
Type E, J, K, L, N, T, U	$\leq \pm 1$ °C	$\leq \pm 0.1$ °C / °C
Type R, S, W3, W5, LR	$\leq \pm 2$ °C	$\leq \pm 0.2$ °C / °C
<b>Note</b>		





### Temperature transducer

- Converts intrinsically safe RTD, thermocouple and mA signals into analogue signals for safe zones.
- PC configuration with FDT/DTM software, download link at [www.weidmueller.com](http://www.weidmueller.com)
- Relay output for failure alarm
- 1 or 2 channels in one module
- 2-channel module, can also be used as a signal splitter

### ACT20X-HTI-2SA0-S / 2HTI-2SA0-S

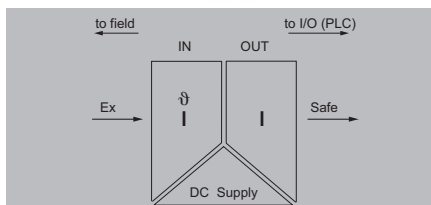

#### Usable as:

- Safety barrier (insulator)
- Signal conversion
- 2-wire measuring transducer
- Amplifier, repeater

### Technical data

Input	
Type	intrinsically safe circuit, RTD, TC, DC (mA)
Temperature input range	Configurable
Line resistance in measuring circuit	≤ 50 Ω
Input current	0...20 mA, 4...20mA
Input resistance, current	20 Ω + PTC 50 Ω
Output	
Output current	0...23 mA, configurable: 0...20 / 4...20 / 20...0 / 20...4 mA, configurable downscale (3.5 mA) / upscale (23 mA) @ error
Output signal limit	3.8...20.5 mA / 0...20.5 mA (dependent on range)
Load impedance current	≤ 600 Ω
Influence of load resistance	≤ 0.01% of span / 100 Ω
Alarm output	
Type	Relay, 1 NC (voltage-free)
Nominal switching voltage	≤ 125 V AC / 110 V DC (safe area) ≤ 32 V AC / 32 V DC (zone 2)
Continuous current	≤ 0.5 A AC / 0.3 A DC (safe zone), ≤ 0.5 A AC / 1 A DC (zone 2)
Power rating	≤ 62.5 VA / 32 W (safe area) ≤ 16 VA / 32 W (Zone 2)
General data	
Voltage supply	19.2...31.2 V DC
Power consumption	≤ 0.8 W
Tightening torque, min. / Tightening torque, max.	0.4 Nm / 0.6 Nm
Ambient temperature / Storage temperature	-20 °C...60 °C / -20 °C...85 °C
Approvals	
Approvals	cULus; DETNORVER; DNVGL; EAC; FMEX; FUSAFETY; IECEXKEM; KEMAATEX
Insulation coordination	
Insulation voltage	2.6 kV (input / output)
Rated voltage	300 V
EMC standards	DIN EN 61326, NE 21

Dimensions	
Clamping range (nominal / min. / max.)	mm <sup>2</sup>
Length x width x height	mm
Note	

### Ordering data

1-channel version	
	Screw connection
	PUSH IN connection
2-channel version	
	Screw connection
	PUSH IN connection

Note	
	CBX200 USB configuration adapter - 8978580000

Screw connection		PUSH IN	
	2.5 / 0.25 / 2.5		
	22.5 / 119.2	22.5 / 127.3	

Type	Qty.	Order No.
ACT20X-HTI-2SA0-S	1	8965470000
ACT20X-HTI-2SA0-P	1	2456180000
ACT20X-2HTI-2SA0-S	1	8965480000
ACT20X-2HTI-2SA0-P	1	2456190000

Type	Temperature-range	Accuracy
Metal PTC		
Pt100	-200...850 °C	± (0.15 + 0.02 x T) Class A ± (0.30 °C + 0.005 x T) Class B
Pt500	-200...850 °C	
Pt1000	-200...850 °C	
Ni50		± (0.4 + 0.007 x T) ± (0.4 + 0.028 x T)
Ni100	-60...0 °C	
Ni120	0...180 °C	
Ni1000		
TC-Type according to IEC60584-1		
B	50...250 °C	± 25 K
	250...500 °C	± 10 K
	500...1820 °C	± 6 K
E	-200...-150 °C	± 4 K
	-150...-1000 °C	± 3 K
J	-200...-150 °C	± 4 K
	-150...-1200 °C	± 3 K
K	-200...-150 °C	± 5 K
	-150...-1200 °C	± 3 K
	1200...1372 °C	± 4 K
N	-200...-150 °C	± 6 K
	-150...-1300 °C	± 3 K
R	-50...-200 °C	± 10 K
	200...1780 °C	± 6 K
S	-50...-200 °C	± 10 K
	200...1780 °C	± 6 K
T	-200...-150 °C	± 5 K
	-150...-400 °C	± 3 K
according to DIN43710		
U	0...600 °C	± 3 °C
L	0...900 °C	± 3 °C

## Pulse isolators with relay output

### NAMUR disconnect-switch amplifiers with relay output

The ACT20X-HDI-SDO-RNO (NC) isolating switching amplifier is a specialised signal isolating converter for Namur sensor signals or for volt-free contacts from a Zone 0 hazardous area. A single relay, available optionally as NC or NO, provides the output signal in the safe zone. Single-channel or double-channel versions are also available.

**EX area Zone 0, 1, 2, 20, 21, 22**

**Safe area Zone 2 / FM Class 1, Division 2**

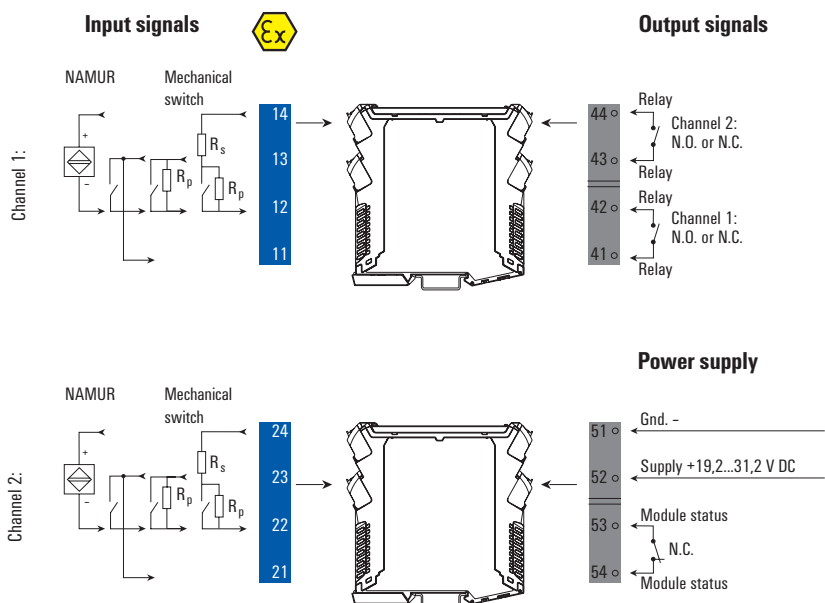

#### Ex label (excerpt)

ATEX	FM	$U_o$	10.6 V
II 3 G Ex nA nC IIC T4	Installation in CL I DIV2 GP A-D T4	$I_o$	12 mA
II (1) G [Ex ia Ga] IIC/IIB/IIA	KI. III ABT 1/2 GP A-G oder	$P_o$	32 mW
II (1) D [Ex iaD]	KI. I Zn2 AEx/Ex nA nC [ia] IIC T4	$L_s / R_s$	1150 $\mu$ H/ $\Omega$
<b>IECEX</b>	Example:	IIC	$C_o = 2 \mu$ F, $L_s = 260$ mH
Ex nA nC IIC T4 Gc	ATEX version,	IIB	$C_o = 6 \mu$ F, $L_s = 780$ mH
[Ex ia Ga] IIC/IIB/IIA	Ex input	IIA	$C_o = 18 \mu$ F, $L_s = 1000$ mH
[Ex ia Da] IIIC	(More details in ATEX certificate)		

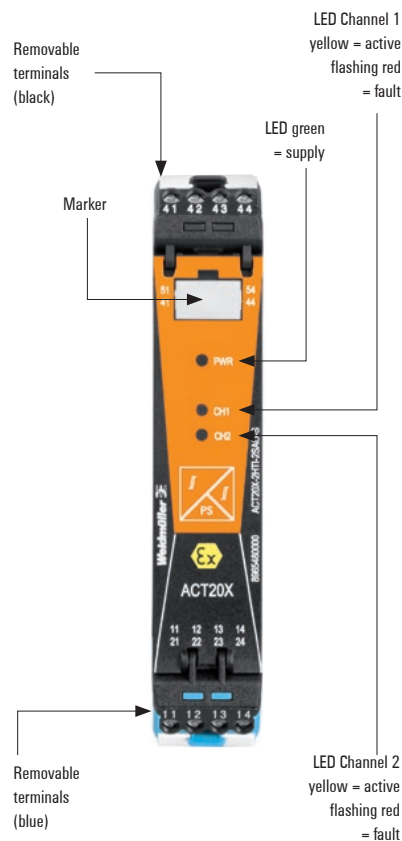

#### Application: monitoring of fill level with the ACT20X HDI-SDO-RNO (relay output)

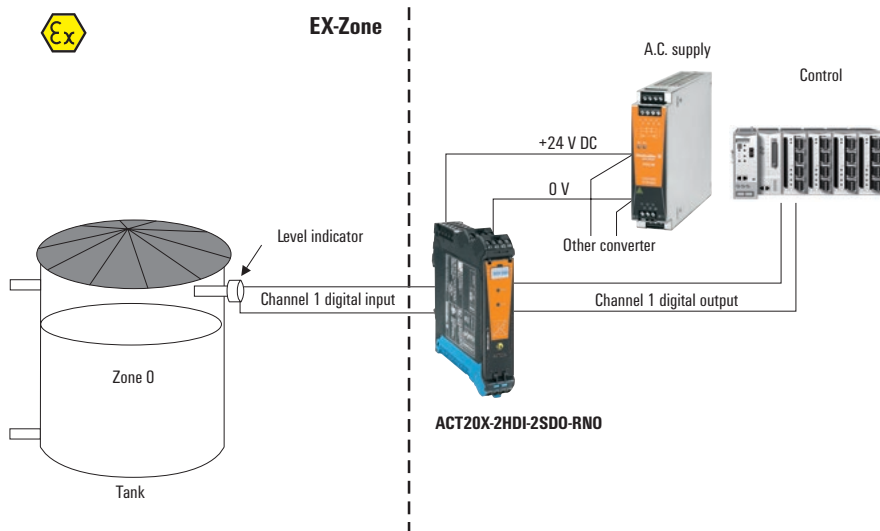

### NAMUR isolating switching amplifier

- Converts intrinsically safe digital signals (NAMUR / switching contact) from EX Zone 0 into digital output signals (relay output) for the safe zone
- PC configuration with FDT/DTM software, download at [www.weidmueller.com](http://www.weidmueller.com)
- Relay output for error alarm, cable break, short-circuit
- 1 or 2 channels in one module

### ACT20X-HDI-SDO-RNO-S / RNC-S ACT20X-2HDI-2SDO-RNO-S / RNC-S

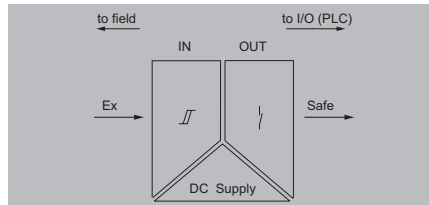

#### Technical data

<b>Input</b>
Sensor
Sensor supply
Resistance
Input frequency
Trigger level low / Trigger level high
Output signal in case of wire break
<b>Output</b>
Type
Nominal switching voltage
<b>Alarm output</b>
Type
Nominal switching voltage
<b>General data</b>
Voltage supply
Power consumption
Ambient temperature / Storage temperature
<b>Approvals</b>
Approvals
<b>Insulation coordination</b>
Insulation voltage
Rated voltage
EMC standards

NAMUR sensor, according to EN60947-5-6, switch with or w/o RS, RP
8 V DC / 8 mA
RP = 750 Ω / RS = 15kΩ
< 20 Hz
< 1.2 mA / > 2.1 mA
< 0.1 mA, > 6.5 mA (in case of wire break)
Relay, 1 NO, Switching frequency 20 Hz
≤ 250 V AC / 30 V DC (safe area)
≤ 32 V AC / 32 V DC (zone 2)
Relay, 1 NC (voltage-free)
≤ 125 V AC / 110 V DC (safe area)
≤ 32 V AC / 32 V DC (zone 2)
19.2...31.2 V DC
≤ 1.3 W
-20 °C...60 °C / -20 °C...85 °C
cULus; DETNORVER; DNVGL; EAC; FMEX; FUSAFETY; IECEXKEM; KEMAATEX
2.6 kV (input / output)
300 V
DIN EN 61326, NE 21

<b>Dimensions</b>	
Clamping range (nominal / min. / max.)	mm <sup>2</sup>
Length x width x height	mm
<b>Note</b>	

<b>Screw connection</b>	<b>PUSH IN</b>
2.5 / 0.25 / 2.5	
22.5 / 119.2	22.5 / 127.3

#### Ordering data

<b>1-channel version, NO</b>	Screw connection
	PUSH IN connection
<b>1-channel version, NC</b>	Screw connection
	PUSH IN connection
<b>2-channel version, NO</b>	Screw connection
	PUSH IN connection
<b>2-channel version, NC</b>	Screw connection
	PUSH IN connection
<b>Note</b>	

Type	Qty.	Order No.
ACT20X-HDI-SDO-RNO-S	1	8965340000
ACT20X-HDI-SDO-RNO-P	1	2456050000
ACT20X-HDI-SDO-RNC-S	1	8965350000
ACT20X-HDI-SDO-RNC-P	1	2456060000
ACT20X-2HDI-2SDO-RNO-S	1	8965370000
ACT20X-2HDI-2SDO-RNO-P	1	2456080000
ACT20X-2HDI-2SDO-RNC-S	1	8965380000
ACT20X-2HDI-2SDO-RNC-P	1	2456090000
CBX200 USB configuration adapter - 8978580000		

**Pulse isolators with transistor output**

**NAMUR disconnect-switch amplifiers with NPN transistor output**

The ACT20X-HDI-SDO isolating switching amplifier is a digital pulse signal isolator for Namur sensors or volt-free contacts from a Zone 0 hazardous area. A transistor (NPN) output is provided for the receiver or controller in the safe area. Single-channel or double-channel versions are also available.

**EX area Zone 0, 1, 2, 20, 21, 22**

**Safe area Zone 2 / FM Class 1, Division 2**

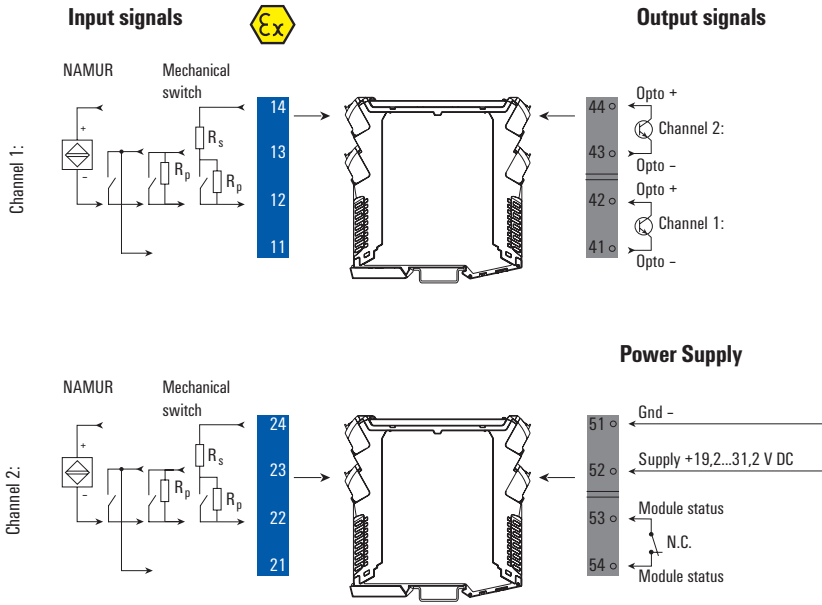

**Ex label (excerpt)**

<b>ATEX</b>	<b>FM</b>	$U_o$	10.6 V
II 3 G Ex nA nC IIC T4	Installation in CL I DIV2 GP A-D T4	$I_o$	12 mA
II (1) G [Ex ia Ga] IIC/IIB/IIA	KI. III ABT 1/2 GP A-G oder	$P_o$	32 mW
II (1) D [Ex iaD]	KI. I Zn2 AEx/Ex nA nC [ia] IIC T4	$L_s / R_s$	1150 $\mu$ H/ $\Omega$
<b>IECEX</b>	Example:	IIC	$C_o = 2 \mu$ F, $L_s = 260$ mH
Ex nA nC IIC T4 Gc	ATEX version	IIB	$C_o = 6 \mu$ F, $L_s = 780$ mH
[Ex ia Ga] IIC/IIB/IIA	Ex input	IIA	$C_o = 18 \mu$ F, $L_s = 1000$ mH
[Ex ia Da] IIIC	(More details in ATEX certificate)		



**Application: monitoring the fill level with isolating switching amplifier**

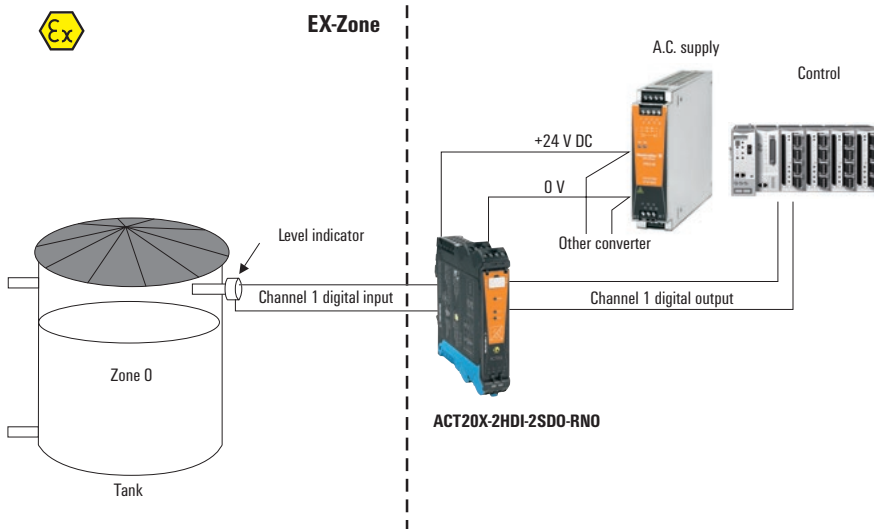

### NAMUR isolating switching amplifier

- Converts intrinsically safe signals (NAMUR / switching contact) from EX Zone 0 into digital output signals (relay output) for the safe zone
- PC configuration with FDT/DTM software, download at [www.weidmueller.com](http://www.weidmueller.com)
- Relay output for error alarm
- 1 or 2 channels in one module

### ACT20X-HDI-SDO-S / 2HDI-2SDO-S

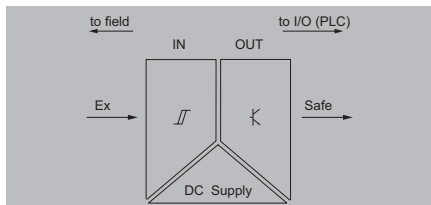

#### Technical data

Input	
Sensor	
Sensor supply	
Resistance	
Input frequency	
Pulse duration	
Input resistance	
Trigger level low / Trigger level high	
Output signal in case of wire break	
Output	
Type	
Pulse duration	
Nominal switching voltage	
Alarm output	
Type	
Nominal switching voltage	
Continuous current	
Power rating	
General data	
Power consumption	
Voltage supply	
Power consumption	
Tightening torque, min. / Tightening torque, max.	
Ambient temperature / Storage temperature	
Approvals	
Approvals	
Insulation coordination	
Insulation voltage	
Rated voltage	
EMC standards	
Dimensions	
Clamping range (nominal / min. / max.)	mm <sup>2</sup>
Length x width x height	mm
Note	

NAMUR sensor, according to EN60947-5-6, switch with or w/o RS, RP	
8 V DC / 8 mA	
Series resistor 750Ω, Parallel resistor 15kΩ	
0...5 kHz	
> 0.1 ms	
1 kΩ	
< 1.2 mA / > 2.1 mA	
< 0.1 mA, > 6.5 mA (in case of wire break)	
Output	
NPN-Transistor	
> 0.1 ms	
30 V DC	
Alarm output	
Relay, 1 NC (voltage-free)	
≤ 125 V AC / 110 V DC (safe area)	
≤ 32 V AC / 32 V DC (zone 2)	
≤ 0.5 A AC / 0.3 A DC (safe zone), ≤ 0.5 A AC / 1 A DC (zone 2)	
≤ 62.5 VA / 32 W (safe area)	
≤ 16 VA / 32 W (Zone 2)	
≤ 1.1 W	
19.2...31.2 V DC	
≤ 1.1 W	
0.4 Nm / 0.6 Nm	
-20 °C...60 °C / -20 °C...85 °C	
cULus; DETNORVER; DNVGL; EAC; FMEX; FUSAFETY; IECEXKEM; KEMAATEX	
2.6 kV (input / output)	
300 V	
DIN EN 61326, NE 21	
Screw connection	
PUSH IN	
2.5 / 0.25 / 2.5	
22.5 / 119.2	22.5 / 127.3

#### Ordering data

1-channel version	
	Screw connection
	PUSH IN connection
2-channel version	
	Screw connection
	PUSH IN connection
Note	

Type	Qty.	Order No.
ACT20X-HDI-SDO-S	1	8965360000
ACT20X-HDI-SDO-P	1	2456070000
ACT20X-2HDI-2SDO-S	1	8965390000
ACT20X-2HDI-2SDO-P	1	2456100000
Note		
CBX200 USB configuration adapter - 8978580000		

## Digital output

### Valve control component for gas group IIC, 35 mA

The ACT20X-SDI-HAO-S solenoid/actuator driver takes a switched input from e.g. a safe area controller and delivers an corresponding output to operate an actuator in a hazardous area, e.g. Zone 0. It is available in a single-channel or double-channel version.

#### EX area Zone 0, 1, 2, 20, 21, 22

#### Safe area Zone 2 /FM KI. 1 Abt. 2

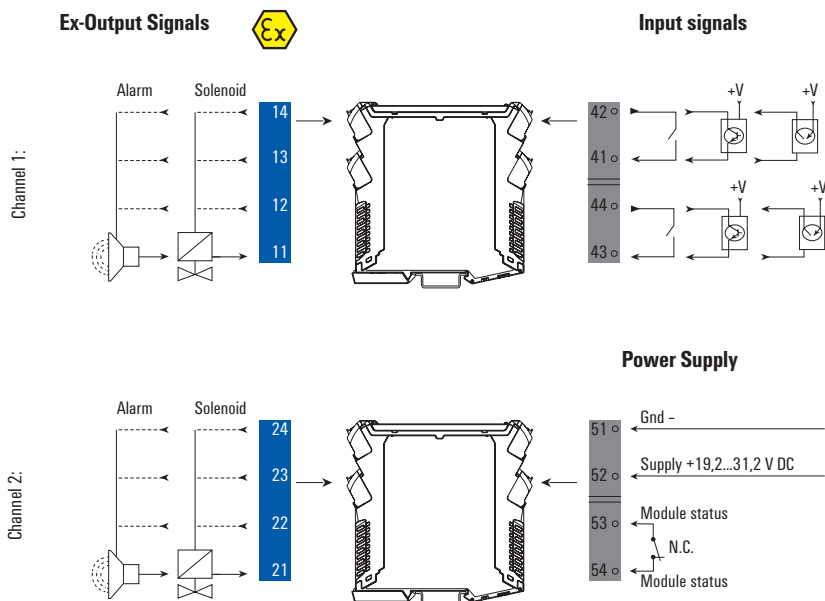

#### Ex label (excerpt)

<b>ATEX</b>	<b>FM</b>	$U_o$	28 V
II 3 G Ex nA nC IIC T4	Installation in CL I DIV2 GP A-D T4	$I_o$	100 mA
II (1) G [Ex ia Ga] IIC/IIB/IIA	KI. HII ABT 1/2 GP A-G oder	$P_o$	0.70 mW
II (1) D [Ex iaD]	KI. I Zn2 AEx/Ex nA nC [ia] IIC T4	IIC	$C_o = 0.08 \mu F, L_o = 2.9 mH$
<b>IECEX</b>	Example:	IIB	$C_o = 0.64 \mu F, L_o = 12.8 mH$
Ex nA nC IIC T4 Gc	ATEX version	IIA	$C_o = 2.1 \mu F, L_o = 22.8 mH$
[Ex ia Ga] IIC/IIB/IIA	Ex Output Terminal (11-14)		
[Ex ia Da] IIIC	(More details in ATEX certificate)		

#### Application: Inflow control in Ex zone with gas group IIC

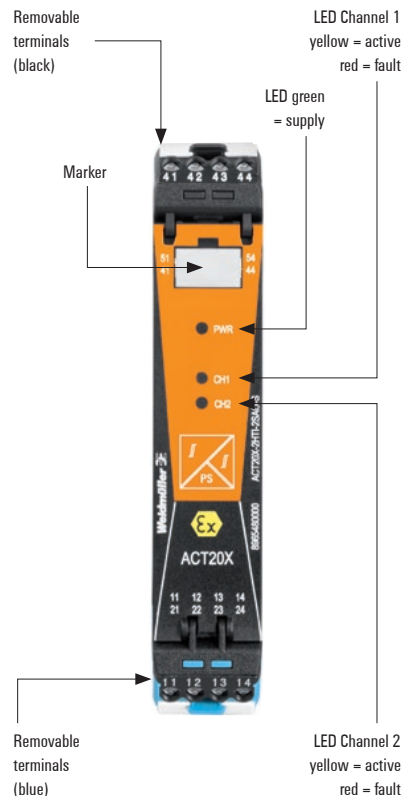
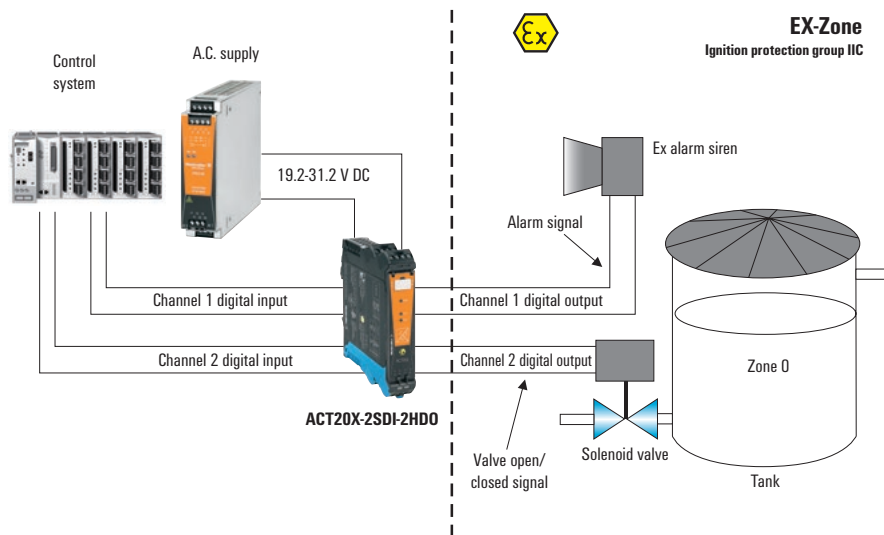

#### Output data

##### For gas group IIC ( $\leq 35$ mA)

Connection terminal			
Channel 1	U without load	U with load	I max
11-12	Min. 24 V	Min. 12.5 V	35 mA
11-13	Min. 24 V	Min. 13.5 V	35 mA
11-14	Min. 24 V	Min. 14.5 V	35 mA

Note

##### For gas group IIC ( $\leq 35$ mA)

Connection terminal			
Channel 2	U without load	U with load	I max
21-22	Min. 24 V	Min. 12.5 V	35 mA
21-23	Min. 24 V	Min. 13.5 V	35 mA
21-24	Min. 24 V	Min. 14.5 V	35 mA

Note

**Solenoid driver**

- Valve control component for control of intrinsically safe valves, LEDs, acoustic alarms, etc.
- PC configuration with FDT/DTM software, download at [www.weidmueller.com](http://www.weidmueller.com)
- Output current is limited to 35 mA for ignition group IIC
- 1 or 2 channels in one module
- Relay output for error alarm

**ACT20X-SDI-HDO / 2SDI-2HDO**

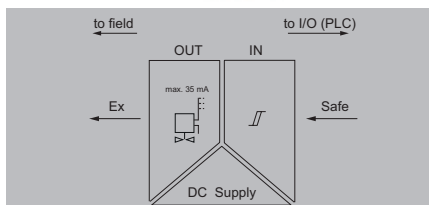

**Technical data**

**Input**

Type  
Input voltage

Input resistance, voltage

**Ex-output**

Type

Output current  
Output values

**Alarm output**

Type  
Nominal switching voltage

Continuous current

Power rating

**General data**

Voltage supply  
Power consumption  
Tightening torque, min. / Tightening torque, max.  
Ambient temperature / Storage temperature

**Approvals**

Approvals

**Insulation coordination**

Insulation voltage  
Rated voltage  
EMC standards

NPN, PNP transistor, switching signal [input safe-side valve component]

≤ 28 V DC, Trigger level low: ≤ 2.0 V DC (NPN), ≤ 8.0 V DC (PNP),  
Trigger level high: ≥ 4.0 V DC (NPN), ≥ 10.0 V DC (PNP)

3.5 kΩ

intrinsically safe circuit, digital, output = input, direct or inverse (configurable)

max. 35 mA

depending on terminal assignment

Relay, 1 NC (voltage-free)

≤ 125 V AC / 110 V DC (safe area)  
≤ 32 V AC / 32 V DC (zone 2)

≤ 0.5 A AC / 0.3 A DC (safe zone), ≤ 0.5 A AC / 1 A DC (zone 2)

≤ 62.5 VA / 32 W (safe area)  
≤ 16 VA / 32 W (Zone 2)

19.2...31.2 V DC

≤ 1.9 W

0.4 Nm / 0.6 Nm

-20 °C...60 °C / -20 °C...85 °C

cULus; DETNORVER; DNVGL; EAC; FMEX; FUSAFETY; IECEXKEM;  
KEMAATEX

2.6 kV (input / output)

300 V

DIN EN 61326, NE 21

**Dimensions**

Clamping range (nominal / min. / max.) mm<sup>2</sup>  
Length x width x height mm

**Note**

**Screw connection      PUSH IN**

2.5 / 0.25 / 2.5  
22.5 / 119.2                      22.5 / 127.1

**Ordering data**

**1-channel version**

Screw connection  
PUSH IN connection

**2-channel version**

Screw connection  
PUSH IN connection

Type	Qty.	Order No.
ACT20X-SDI-HDO-L-S	1	8965400000
ACT20X-SDI-HDO-L-P	1	2456110000
ACT20X-2SDI-2HDO-S	1	8965420000
ACT20X-2SDI-2HDO-P	1	2456130000

**Note**

CBX200 USB configuration adapter - 8978580000

## Digital output

### Valve control component for gas group IIB, 60 mA

The ACT20X-SDI-HAO-S solenoid/actuator driver takes a switched input from e.g. a safe area controller and delivers an corresponding output to operate an actuator in a hazardous area, e.g. Zone.

This driver is suitable for switching solenoid valves or alarm devices.

EX area Zone 0, 1, 2, 20, 21, 22

Safe area Zone 2 / FM Class 1, Division 2

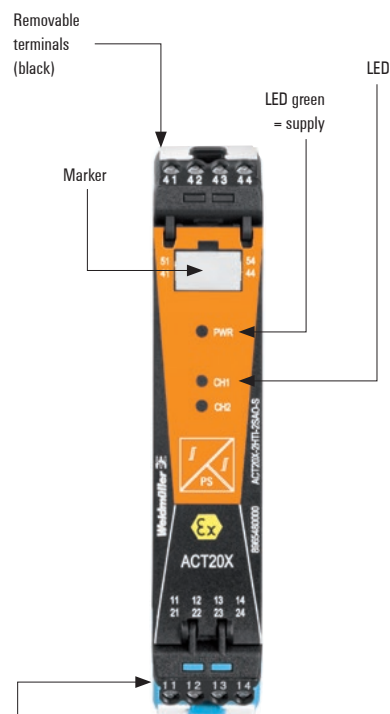
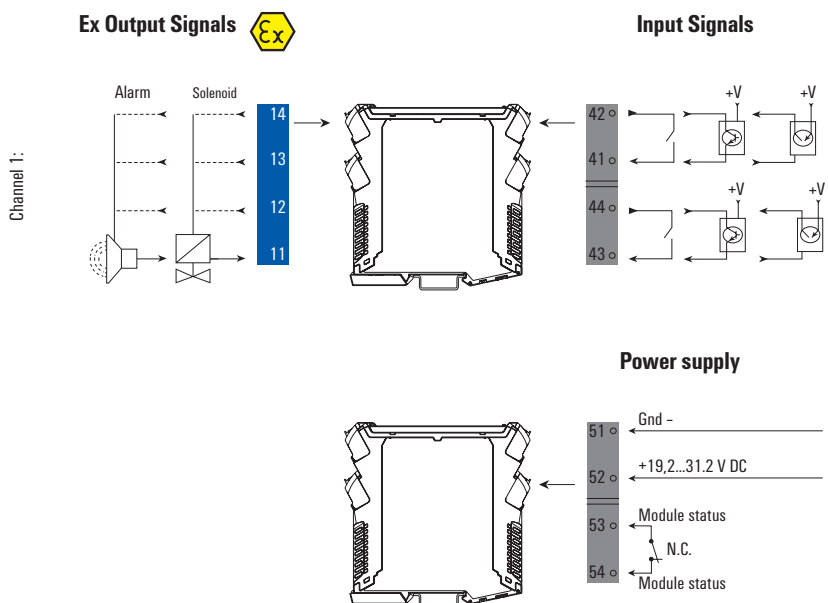

Removable terminals (blue)



### Ex label (excerpt)

ATEX	FM	U <sub>0</sub>	28 V
II 3 G Ex nA nC IIC T4	Installation in CL I DIV2 GP A-D T4	I <sub>0</sub>	135 mA
II (1) G [Ex ia Ga] IIC/IIB/IIA	KI. III ABT 1/2 GP A-G oder	P <sub>0</sub>	0.95 W
II (1) D [Ex iaD]	KI. I Zn2 AEx/Ex nA nC [ia] IIC T4	IIC	C <sub>0</sub> = -, L <sub>0</sub> = -
<b>IECEX</b>	Example:	IIB	C <sub>0</sub> = 0.64 µF, L <sub>0</sub> = 7.8 mH
Ex nA nC IIC T4 Gc	ATEX version,	IIA	C <sub>0</sub> = 2.1 µF, L <sub>0</sub> = 15.1 mH
[Ex ia Ga] IIC/IIB/IIA	Ex Output Terminal (11-14)		
[Ex ia Da] IIIC	(More details in ATEX certificate)		

### Application: Inflow control in Ex zone with gas group IIB

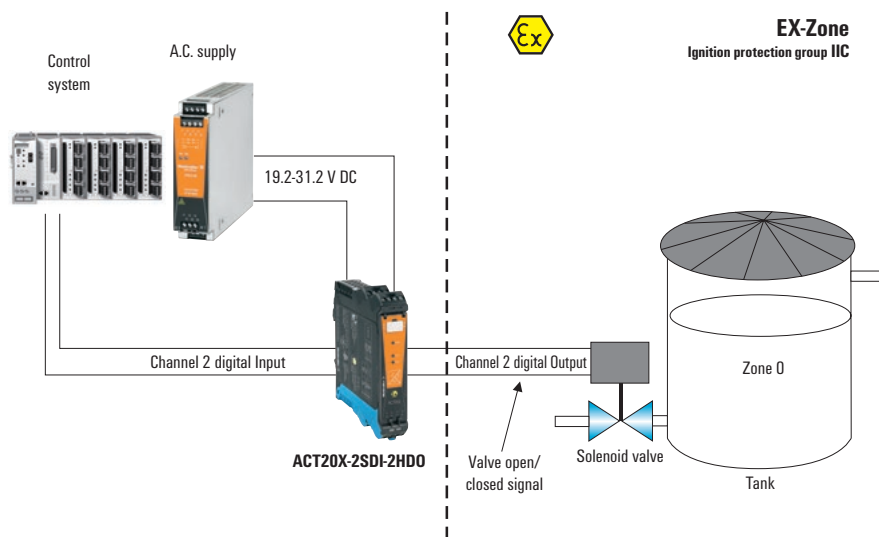

### Output data For gas group IIB (≤ 60 mA)

Connection terminal	Channel 1	U without load	U with load	I max
11-12		Min. 24 V	Min. 9 V	60 mA
			Min. 11.5 V	50 mA
11-13		Min. 24 V	Min. 12.5 V	60 mA
			Min. 10 V	50 mA
11-14		Min. 24 V	Min. 11 V	60 mA
			Min. 13 V	50 mA

**Note**



**Solenoid driver**

- Valve control component for control of intrinsically safe valves, LEDs, acoustic alarms, etc.
- PC configuration with FDT/DTM software, download at [www.weidmueller.com](http://www.weidmueller.com)
- Output current is limited to 35 mA for ignition group IIC
- 1 or 2 channels in one module
- Relay output for error alarm

**ACT20X-SDI-HDO-H-S**

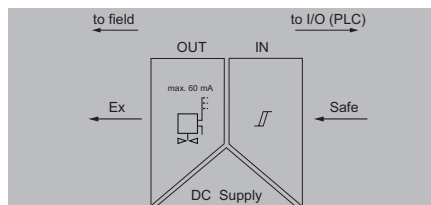

**Technical data**

<b>Input</b>	
Type	
Input voltage	
Input resistance, voltage	
<b>Ex-output</b>	
Type	
Output current	
Output values	
<b>Alarm output</b>	
Type	
Nominal switching voltage	
Continuous current	
Power rating	
<b>General data</b>	
Voltage supply	
Power consumption	
Tightening torque, min. / Tightening torque, max.	
Ambient temperature / Storage temperature	
<b>Approvals</b>	
Approvals	
<b>Insulation coordination</b>	
Insulation voltage	
Rated voltage	
EMC standards	
<b>Dimensions</b>	
Clamping range (nominal / min. / max.)	mm <sup>2</sup>
Length x width x height	mm
<b>Note</b>	

NPN, PNP transistor, switching signal [input safe-side valve component]	
≤ 28 V DC, Trigger level low: ≤ 2.0 V DC (NPN), ≤ 8.0 V DC (PNP), Trigger level high: ≥ 4.0 V DC (NPN), ≥ 10.0 V DC (PNP)	
3.5 kΩ	
intrinsically safe circuit, digital, output = input, direct or inverse (configurable)	
max. 60 mA	
depending on terminal assignment	
Relay, 1 NC (voltage-free)	
≤ 125 V AC / 110 V DC (safe area)	
≤ 32 V AC / 32 V DC (zone 2)	
≤ 0.5 A AC / 0.3 A DC (safe zone), ≤ 0.5 A AC / 1 A DC (zone 2)	
≤ 62.5 VA / 32 W (safe area)	
≤ 16 VA / 32 W (Zone 2)	
19.2...31.2 V DC	
≤ 2.5 W	
0.4 Nm / 0.6 Nm	
-20 °C...60 °C / -20 °C...85 °C	
cULus; DETNORVER; DNVGL; EAC; FMEX; FUSAFETY; IECEXKEM; KEMAATEX	
2.6 kV (input / output)	
300 V	
DIN EN 61326, NE 21	
<b>Screw connection</b>	
<b>PUSH IN</b>	
2.5 / 0.25 / 2.5	
22.5 / 119.2	22.5 / 127.1

**Ordering data**

<b>1-channel version</b>	
	Screw connection
	PUSH IN connection
<b>Note</b>	

Type	Qty.	Order No.
ACT20X-SDI-HDO-H-S	1	8965410000
ACT20X-SDI-HDO-H-P	1	2456120000
<b>Note</b>		
CBX200 USB configuration adapter - 8978580000		

**Universal measurement transducers**

**Universal measurement transducers for temperature, standard and potentiometer signals**

The ACT20X-HUI-SA0-S is a universal input signal isolator/converter. This model processes temperature signals from PT100 sensors and thermocouples as well as DC voltage and current signals (mA) from the hazardous area. On the output side, an isolated milliamp signal is passed to the receiver or controller in the safe area. This model also has a relay output which can be used for a process alarm or trip.

**EX area Zone 0, 1, 2, 20, 21, 22**

**Safe area Zone 2 / FM Class 1, Division 2**

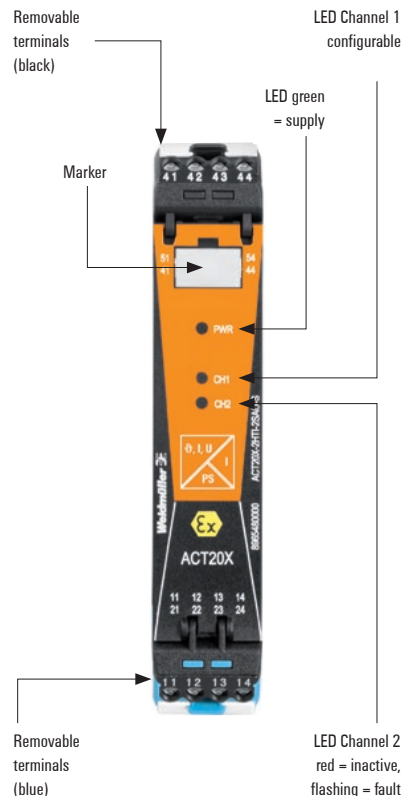
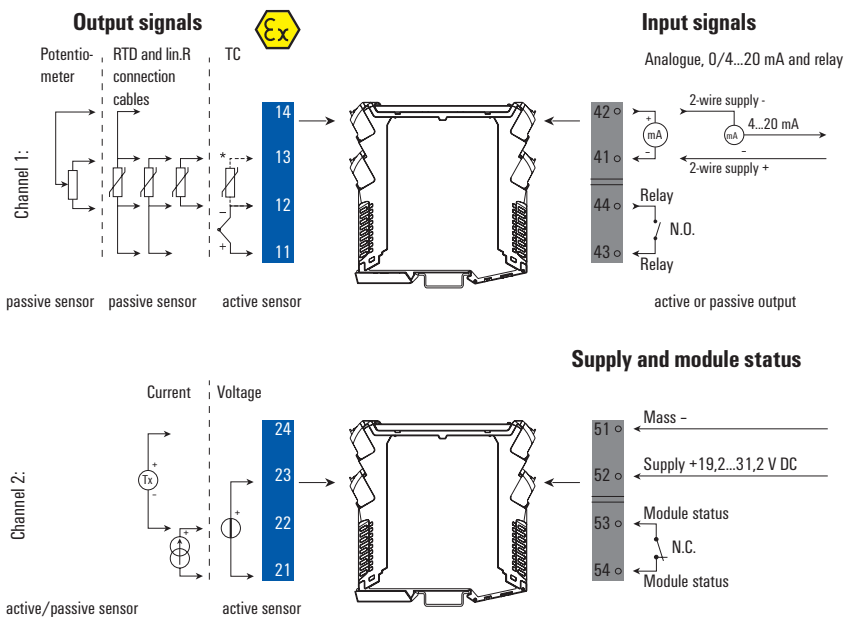

**Ex label (excerpt)**

<b>ATEX</b>	<b>FM</b>	$U_i / U_o$	30 V / 8.3 V
II 3 G Ex nA nC IIC T4	Installation in CL I DIV2 GP A-D T4	$I_i / I_o$	120 mA / 0.2 mA
II (1) G [Ex ia] IIC/IIB/IIA	KI, III ABT 1/2 GP A-G or	$P_i / P_o$	900 mW / 0.4 mW
II (1) D [Ex iaD]	KI, I Zn2 AEx/Ex nA nC [ia] IIC T4	$C_i$	3 nF
<b>IECEX</b>	Example:	$L_i$	1 $\mu$ H
Ex nA nC IIC T4 Gc	ATEX version,	IIC	$C_o = 7 \mu$ F $L_o = 1000$ mH
[Ex ia Ga] IIC/IIB/IIA	Ex input External Current Source	IIB	$C_o = 73 \mu$ F $L_o = 1000$ mH
[Ex ia a] IIC	(More details in ATEX certificate)	IIA	$C_o = 1000 \mu$ F $L_o = 1000$ mH



**Application example: position measurement of an actuator**

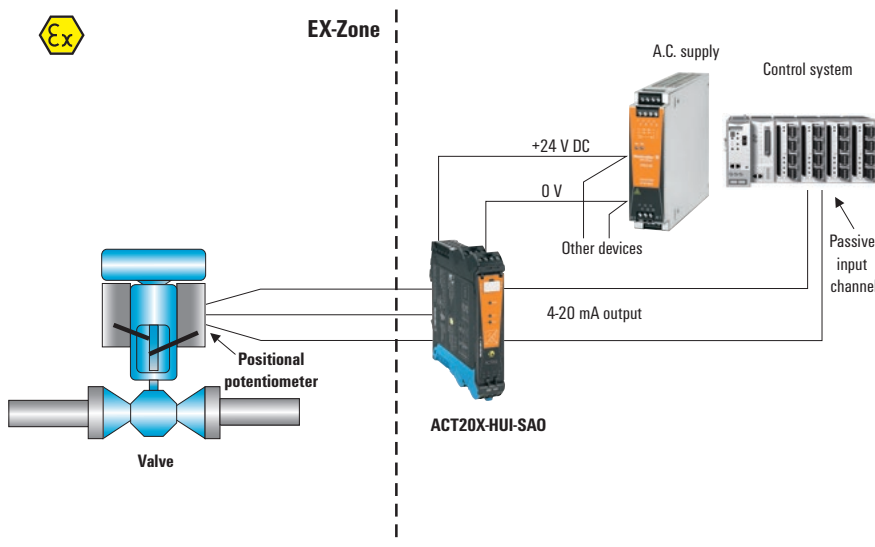

**Accuracy / temperature coefficients**  
**ACT20X-HUI-SA0**

Input	Accuracy	Temperature coefficient
Input mA	$\leq \pm 4 \mu$ A	$\leq \pm 4 \mu$ A / °C
Input Volt	$\leq \pm 20 \mu$ V	$\leq \pm 2 \mu$ V / °C
<b>Input RTD</b>		
Pt100	$\leq \pm 0.2$ °C	$\leq \pm 0.02$ °C / °C
Ni100	$\leq \pm 0.3$ °C	$\leq \pm 0.03$ °C / °C
<b>Input TC</b>		
Type B	$\leq \pm 4.5$ °C	$\leq \pm 0.45$ °C / °C
Type E, J, K, L, N, T, U	$\leq \pm 1$ °C	$\leq \pm 0.1$ °C / °C
Type R, S, W3, W5, LR	$\leq \pm 2$ °C	$\leq \pm 0.2$ °C / °C
<b>Note</b>		

**Universal signal converter**

- Universal isolator for intrinsically safe RTD signals, thermal sensor signals, resistor signals, potentiometer signals and DC signals (mA,V)
- PC configuration with FDT/DTM software, download at [www.weidmueller.com](http://www.weidmueller.com)
- Digital relay output adjustable as threshold switch
- Relay output for error alarm

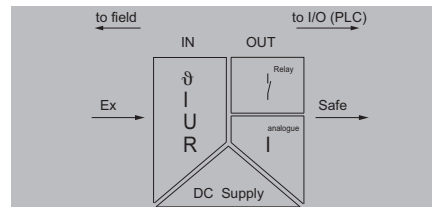
**ACT20X-HUI-SA0-S**

**Usable as:**

- Safety barrier (insulator)
- Signal conversion
- 2-wire measuring transducer
- Amplifier, repeater

**Technical data**

Input	
Type	
Temperature input range	
Line resistance in measuring circuit	
Input current	
Input voltage	
Potentiometer	
Input resistance, voltage/current	
Output analogue	
Output current	
Output signal limit	
Load impedance current	
Output digital	
Type	
Function	
Nominal switching voltage	
Continuous current	
Alarm output	
Type	
Nominal switching voltage	
General data	
Voltage supply	
Power consumption	
Ambient temperature / Storage temperature	
Approvals	
Approvals	
Insulation coordination	
Insulation voltage / Rated voltage	
EMC standards	
Dimensions	
Clamping range (nominal / min. / max.)	mm <sup>2</sup>
Length x width x height	mm
Note	

intrinsically safe circuit, active (as current source) or passive (as current sink)	
Adjustable from -200...+800°C	
≤ 50 Ω	
0...20 mA, 4...20 mA	
configurable, 0...1 V DC, 0,2...1 V DC, 1...5 V DC, 0...(5)10 V, 2...10 V DC	
10 Ω...10 kΩ	
> 10 MΩ @ 600 mV, 2 MΩ @ 28 V / 20 Ω + PTC 50 Ω	
0...23 mA, configurable: 0...20 / 4...20 / 20...0 / 20...4 mA, configurable downscale (3.5 mA) / upscale (23 mA) @ error	
3.8...20.5 mA / 0...20.5 mA (dependent on range)	
≤ 600 Ω	
Relay, 1 NO / NC contact	
Configurable switching thresholds, Sensor error, Window function	
≤ 250 V AC / 30 V DC (safe area)	
≤ 32 V AC / 32 V DC (zone 2)	
≤ 2 A AC/DC (safe area, Zone 2 area)	
Relay, 1 NC (voltage-free)	
≤ 125 V AC / 110 V DC (safe area)	
≤ 32 V AC / 32 V DC (zone 2)	
19.2...31.2 V DC	
≤ 2.1 W	
-20 °C...60 °C / -20 °C...85 °C	
cULus; DETNORVER; DNVGL; EAC; FMEX; FUSAFETY; IECEXKEM; KEMAATEX	
2.6 kV (input / output) / 300 V	
DIN EN 61326, NE 21	
Screw connection	PUSH IN
2.5 / 0.25 / 2.5	
22.5 / 119.2	22.5 / 127.3

Type	Temperature-range	Accuracy
Metal PTC		
Pt100	-200...850 °C	± (0.15 + 0.02 x T) Class A ± (0.30 °C + 0.005 x T) Class B
Pt500	-200...850 °C	
Pt1000	-200...850 °C	
Ni50		± (0.4 + 0.007 x T) ± (0.4 + 0.028 x T)
Ni100	-60...0 °C	
Ni120	0...180 °C	
Ni1000		
TC-Type according to IEC60584-1		
B	50...250 °C	± 25 K
	250...500 °C	± 10 K
	500...1820 °C	± 6 K
E	-200...-150 °C	± 4 K
	-150...-1000 °C	± 3 K
J	-200...-150 °C	± 4 K
	-150...1200 °C	± 3 K
K	-200...-150 °C	± 5 K
	-150...1200 °C	± 3 K
N	1200...1372 °C	± 4 K
	-200...-150 °C	± 6 K
R	-150...1300 °C	± 3 K
	-50...200 °C	± 10 K
S	200...1780 °C	± 6 K
	-50...200 °C	± 10 K
T	200...1780 °C	± 6 K
	-200...-150 °C	± 5 K
	-150...400 °C	± 3 K
according to DIN43710		
U	0...600 °C	± 3 °C
L	0...900 °C	± 3 °C

**Ordering data**

1-channel version	
	Screw connection
	PUSH IN connection

Type	Qty.	Order No.
ACT20X-HUI-SA0-S	1	8965490000
ACT20X-HUI-SA0-P	1	2456200000

Note
CBX200 USB configuration adapter - 8978580000

**Universal measurement transducers**

**Output-powered universal measurement transducers**

The ACT20X-HUI-SA0-LP is a universal input, isolating signal converter. This model processes temperature signals from PT100 sensors and thermocouples as well as DC voltage and current signals (mA) from the hazardous area. The 12.5 mm wide module is powered through it's 4-20 mA output.

**EX area Zone 0, 1, 2, 20, 21, 22**

**Safe area Zone 2 / FM Class 1, Division 2**

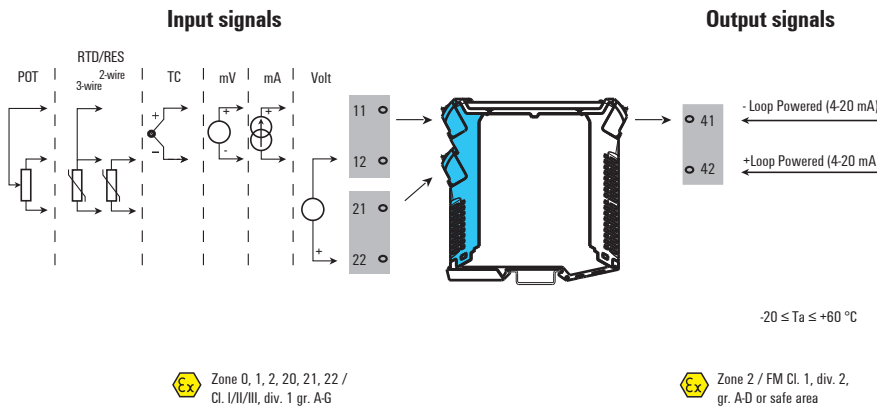

**Ex label**

<b>ATEX</b>		$U_o$	5.88 V
II 3 G Ex nA nC IIC T4		$I_o$	3.1 mA
II (1) G [Ex ia] IIC/IIB/IIA		$P_o$	4.6 mW
II (1) D [Ex iaD]		$C_i$	0.001 $\mu\text{F}$
<b>IECEx</b>		$L_i$	negligible
Ex nA IIC T4 Gc	Example:		
[Ex ia Ma Ga] I/IIC [Ex ia Da] IIC	IECEx version		
	(More details in IECEx certificate)		

**Application example: Temperature measurement in the EX-zone**

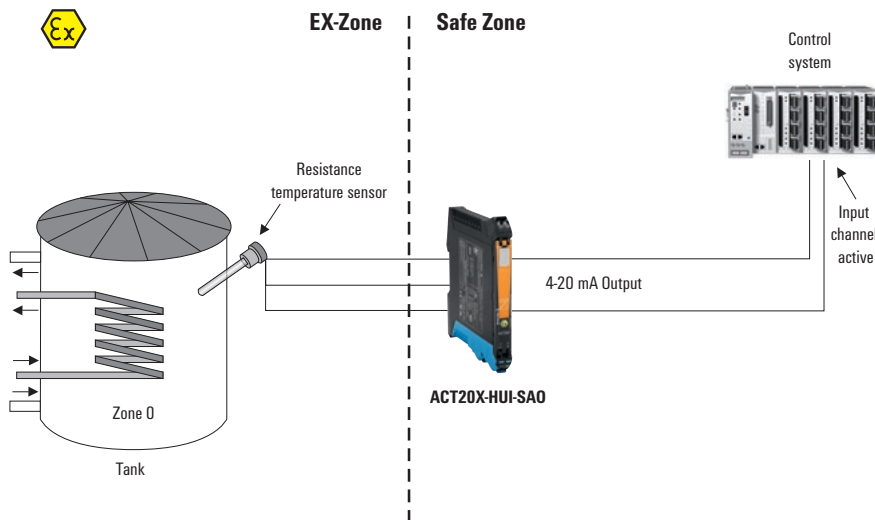

**Accuracy / temperature coefficients**  
**ACT20X-HUI-SA0-LP**

Input	Accuracy	Temperature coefficient
Input mA	$\leq \pm 4 \mu\text{A}$	$\leq \pm 4 \mu\text{A} / \text{ }^\circ\text{C}$
Input Volt	$\leq \pm 20 \mu\text{V}$	$\leq \pm 2 \mu\text{V} / \text{ }^\circ\text{C}$
<b>Input RTD</b>		
Pt100	$\leq \pm 0.2 \text{ }^\circ\text{C}$	$\leq \pm 0.02 \text{ }^\circ\text{C} / \text{ }^\circ\text{C}$
Ni100	$\leq \pm 0.3 \text{ }^\circ\text{C}$	$\leq \pm 0.03 \text{ }^\circ\text{C} / \text{ }^\circ\text{C}$
<b>Input TC</b>		
Type B	$\leq \pm 4.5 \text{ }^\circ\text{C}$	$\leq \pm 0.45 \text{ }^\circ\text{C} / \text{ }^\circ\text{C}$
Type E, J, K, L, N, T, U	$\leq \pm 1 \text{ }^\circ\text{C}$	$\leq \pm 0.1 \text{ }^\circ\text{C} / \text{ }^\circ\text{C}$
Type R, S, W3, W5, LR	$\leq \pm 2 \text{ }^\circ\text{C}$	$\leq \pm 0.2 \text{ }^\circ\text{C} / \text{ }^\circ\text{C}$
<b>Note</b>		



**Universal measurement and signal isolator-converter**

**Output-loop powered**

- Universal isolator for intrinsically safe RTD signals, thermal sensor signals, resistor signals, potentiometer signals and DC signals (mA,V)
- Supply via output loop
- 12.5 mm thin housing
- PC configuration with FDT/DTM software, download at [www.weidmuller.com](http://www.weidmuller.com)

**ACT20X-HUI-SA0-LP-S**

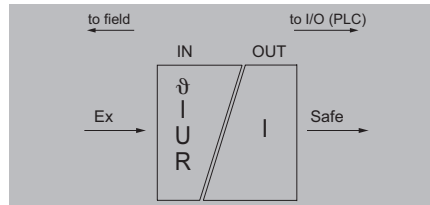

**Technical data**

Input	
Type	intrinsically safe circuit
Temperature input range	Adjustable from -200...+800°C
Input current	configurable, ± 25 mA, 0...20 mA, 4...20mA
Input voltage	configurable, ± 12 V DC (min. measurement range 1 V), ± 28 V DC (min. measurement range 2 V), ± 600 mV DC (min. measurement range 50 mV), ± 150 mV DC (min. measurement range 15 mV)
Potentiometer	1.2...500 kΩ
Input resistance, voltage/current	> 10 MΩ @ 600 mV, 2 MΩ @ 28 V / 70 Ω
Output analogue	
Output current	4...20 mA (max. 23 mA)
Load impedance current	≤ 700 Ω
Residual ripple (current loop)	≤ 10 mV <sub>ss</sub>
Accuracy	< 0.1 % of end value
Temperature coefficient	< 0.02 °C of measuring range / °C
Step response time	250 ms (10...90%)
Cut-off frequency (-3 dB)	100 Hz
General data	
Voltage supply	via output current loop, 11...28 V DC (loop powered)
Tightening torque, min. / Tightening torque, max.	0.4 Nm / 0.6 Nm
Ambient temperature / Storage temperature	0 °C...60 °C / -20 °C...70 °C
Approvals	
Approvals	CE, EAC
Insulation coordination	
Insulation voltage / Rated voltage	3.51 kV between input and output / 300 V <sub>eff</sub>
Rated voltage	300 V <sub>eff</sub>
Standards	DIN EN 61326-1, IEC 61010-1, IEC 61010-2-030, IEC 60079-0, IEC 60079-11, IEC 60079-15, IEC 60079-26
Impulse withstand voltage	4 kV (1.2/50 μs)
Overtoltage category	III
Pollution degree	2
Dimensions	
Clamping range (nominal / min. / max.)	mm <sup>2</sup>
Depth / Width / Height	
Note	

Screw connection		PUSH IN	
2.5 / 0.25 / 2.5		113.6 / 12.5 / 117.2117.2	
113.6 / 12.5 / 117.2117.2		113.6 / 12.5 / 117.2117.2	

**Ordering data**

1-channel version	
	Screw connection
	PUSH IN connection

Type	Qty.	Order No.
ACT20X-HUI-SA0-LP-S	1	1318220000
ACT20X-HUI-SA0-LP-P	1	2456210000

**Note**

CBX200 USB configuration adapter - 8978580000

Inputs				
Type	Thermocouples (TC), RTD, mA, Volt, mV, resistor, potentiometer			
Type	Standard	Lower limit	Upper limit	Min. area
B	IEC584	100 °C	1820 °C	400 °C
E		-270 °C	1000 °C	
J		-270 °C	1200 °C	80 °C
K		-270 °C	1372 °C	
L	DIN43710	-100 °C	900 °C	
N	IEC584	-180 °C	1300 °C	100 °C
R, S		-50 °C	1768 °C	300 °C
T		-270 °C	400 °C	80 °C
U	DIN43710	-200 °C	600 °C	100 °C
User-defined Input	Up to 101 values			
Error detection	Upper error signalling value: 23 mA, Lower error signalling value: 3.5 mA			
mA	±25 mA @ 70 Ω		4 mA	
Volt	±28 V @ 2 MΩ		2.0 V	
	±12 V @ 2 MΩ		1.0 V	
mV	±600 mV @ >10 MΩ		50 mV	
	±150 mV @ >10 MΩ		15 mV	
2-, 3-, 4-wire RTD				
Type	Standard	Lower limit	Upper limit	Min. area
Pt100, Pt200	DIN43710	-200 °C	850 °C	-20 °C
Pt1000		-80 °C	320 °C	15 °C
Ni120		-100 °C	260 °C	100 °C
Cu10	User-defined Input Up to 101 values			
Resistance	0 to 12 kΩ		500 Ω	
	0 to 15 kΩ		100 Ω	
	0 to 750 Ω		50 Ω	
Potentiometer	1.2 kΩ to 500 kΩ			



# Signal converters and monitoring components – ACT20P

<b>Signal converters and monitoring components – ACT20P</b>	Introduction	D.2
	Selection table	D.4
	Signal converters	D.7
	Passive isolators	D.11
	Signal splitters	D.14
	Temperature transducers	D.15
	Measurement and monitoring relays	D.18
	Current measuring transducers	D.20
	Bridge measuring transducers	D.22
	Universal measurement transducers	D.23

# Your practical requirements are many

## Just like our ACT20P signal isolating converters

The reliable isolation and specific conversion of analogue signals plays an increasingly important role in many areas of industry and technology. When we developed the ACT20P signal converter we took full account of various technical requirements of machine engineering, the process industry and energy technology. In particular, the specifications of EN61010-1 provided important basic parameters for the technology of the equipment.



### Perfectly equipped for the machine engineering sector

Filling systems and packaging machines used in the food or pharmaceutical industry, for example, are a classic area of application for signal converters. They convert analogue signals such as temperature, pressure, fill level, flow, weight, etc. directly into standard signals for processing by the PLC. And best of all: a signal converter solution usually costs much less than an input module in the remote-i/o-system adapted to the specific requirements of the sensor.



### Ideally suited for the process industry and energy technology

In water treatment plants, conveyor technology, gas and coal-fired power plants, energy distribution stations and in many other types of plant in the process and energy technology sector signal converters have two main functions: on the one hand, they provide reliable galvanic isolation – especially if the cables of the sensors from the field are several hundred meters in length. On the other hand, our signal converters enable individual signals such as potentiometer signals from rotary encoders or TC type J signals from temperature sensors to be adapted for the standardised inputs of DCS- or Remote-i/o-systems.



**Can be integrated in HART® communication**

Signal converters are suitable for HART®, transparent communication.



**Reliable connection**

Individually customisable protection against mismatching.



**Rapid device replacement**

Practical release lever for simple removal of the female connector.



**More space in the cabinet**

Two channels measure a mere 12.5 mm wide.



**Variants for different applications**

The range of products is rounded off by the intrinsically safe ACT20X signal converter and the high-performance ACT20M signal converter, which is just 6 mm across.



# Selection table

## Selection table

Order No.	Product									Input		Width
		Amount	0...20 mA	4...20 mA	0...10 V	0...5 V	TC	RTD	Frequency	Miscellaneous	Sensor feed	
<b>Signal converters and monitoring components - ACT20P</b>												
<b>Signal converters</b>												
7760054114	ACT20P-CI-CO-S	1	X	X						2/3-wire transmitter, HART <sup>®</sup> transparent	X	12.5 mm
2489680000	ACT20P-CI-CO-P	1	X	X						2/3-wire transmitter, HART <sup>®</sup> transparent	X	12.5 mm
7760054117	ACT20P-2CI-2CO-12-S	2	X	X						4-wire sensor, HART <sup>®</sup> transparent		12.5 mm
2489730000	ACT20P-2CI-2CO-12-P	2	X	X						4-wire sensor, HART <sup>®</sup> transparent		12.5 mm
1540010000	ACT20P-CI-VO-S	1	X	X						2/3-/4-wire sensor	X	12.5 mm
2489740000	ACT20P-CI-VO-P	1	X	X						2/3-/4-wire sensor	X	12.5 mm
7760054306	ACT20P-VM-AO-S	1								0...440 V AC, 0...660 V DC		22.5 mm
<b>Passive isolators</b>												
7760054123	ACT20P-CI-CO-IHP-S	1	X	X						4-wire sensor	X	12.5 mm
7760054124	ACT20P-2CI-2CO-IHP-S	2	X	X						4-wire sensor	X	12.5 mm
7760054122	ACT20P-CI-2CO-OLP-S	1		X						4-wire sensor	X	12.5 mm
7760054118	ACT20P-CI1-CO-OLP-S	1	X							4-wire sensor	X	12.5 mm
7760054119	ACT20P-CI2-CO-OLP-S	1		X						4-wire sensor	X	12.5 mm
7760054121	ACT20P-VI-CO-OLP-S	1			X					4-wire sensor	X	12.5 mm
7760054120	ACT20P-VI1-CO-OLP-S	1				X				4-wire sensor	X	12.5 mm
7760054122	ACT20P-CI-2CO-OLP-S	1		X						4-wire sensor	X	12.5 mm
<b>Signal splitters</b>												
7760054115	ACT20P-CI-2CO-S	1	X	X						2/3-/4-wire sensor, HART <sup>®</sup> transparent	X	12.5 mm
2489710000	ACT20P-CI-2CO-P	1	X	X						2/3-/4-wire sensor, HART <sup>®</sup> transparent	X	12.5 mm
<b>Temperature transducer</b>												
7760054305	ACT20P-TMR-RTI-S	1						X		PT100		22.5 mm
2448100000	ACT20P-PRO-RTCI-AO-DO-S	1					X	X		RTD, SRTD, Pot, mV, resistance	X	12.5 mm
2448110000	ACT20P-PRO-RTCI-AO-DO-P	1					X	X		RTD, SRTD, Pot, mV, resistance	X	12.5 mm
7940045760	ACT20P-UI-2RCO-DC-S	1	X	X	X	X	X	X		± 25 mA, ± 5 A DC, ± 30 V DC, ± 300 V DC, potentiometer, resistance	X	22.5 mm
2456840000	ACT20P-UI-2RCO-DC-P	1	X	X	X	X	X	X		± 25 mA, ± 5 A DC, ± 30 V DC, ± 300 V DC, potentiometer, resistance	X	22.5 mm
1238910000	ACT20P-UI-2RCO-AC-S	1	X	X	X	X	X	X		± 25 mA, ± 5 A DC, ± 30 V DC, ± 300 V DC, potentiometer, resistance	X	22.5 mm
2495690000	ACT20P-UI-2RCO-AC-P	1	X	X	X	X	X	X		± 25 mA, ± 5 A DC, ± 30 V DC, ± 300 V DC, potentiometer, resistance	X	22.5 mm
<b>Measurement and monitoring relays</b>												
7760054164	ACT20P-VMR-1PH-H-S	1								1 phase 0...400 V AC/DC		22.5 mm
7760054165	ACT20P-VMR-3PH-IHP-H-S	1								3 phases 180...500 V AC		22.5 mm
<b>Current measuring transducers</b>												
2044850000	ACT20P-CML-10-AO-RC-S	1								0...1/5/10 A AC/DC		17.5 mm
2489910000	ACT20P-CML-10-AO-RC-P	1								0...1/5/10 A AC/DC		17.5 mm
1510470000	ACT20P-CMT-10-AO-RC-S	1								0...5/10 A AC/DC		22.5 mm
1510540000	ACT20P-CMT-30-AO-RC-S	1								0...20/25/30 A AC/DC		22.5 mm
1510440000	ACT20P-CMT-60-AO-RC-S	1								0...40/50/60 A AC/DC		22.5 mm
1510390000	ACT20P-CMT-60-RC-S	1								0...40/50/60 A AC/DC		22.5 mm
1510330000	ACT20P-CMT-10-AO-RC-P	1								0...5/10 A AC/DC		22.5 mm
1510320000	ACT20P-CMT-30-AO-RC-P	1								0...20/25/30 A AC/DC		22.5 mm
1510290000	ACT20P-CMT-60-AO-RC-P	1								0...40/50/60 A AC/DC		22.5 mm
1510280000	ACT20P-CMT-60-RC-P	1								0...40/50/60 A AC/DC		22.5 mm
<b>Bridge measuring transducers</b>												
1067250000	ACT20P-BRIDGE-S	1								4-6-wire strain gauge	X	22.5 mm
2456820000	ACT20P-BRIDGE-P	1								4-6-wire strain gauge	X	22.5 mm
<b>Universal measurement transducers</b>												
1481970000	ACT20P-PRO DCDC I-I-S	1	X	X	X	X				± 100 mA, ± 300 V DC	X	12.5 mm
1481960000	ACT20P-PRO DCDC I-I-P	1	X	X	X	X				± 100 mA, ± 300 V DC	X	12.5 mm
1453210000	ACT20P-UI-AO-DO-LP-S	1	X	X	X	X	X	X		± 25 mA, ± 5 A DC, ± 28 V DC, ± 300 V DC, 300 V AC	X	12.5 mm
2456850000	ACT20P-UI-AO-DO-LP-P	1	X	X	X	X	X	X		± 25 mA, ± 5 A DC, ± 28 V DC, ± 300 V DC, 300 V AC	X	12.5 mm
1477420000	ACT20P-AI-AO-DC-S	1	X	X	X	X				0...11 V, 0...22 mA	X	12.5 mm
2456860000	ACT20P-AI-AO-DC-P	1	X	X	X	X				0...11 V, 0...22 mA	X	12.5 mm

Amount	Output					Configuration	Auxiliary power	Rated voltage	Isolation	Connection system	Special characteristics
	0...20 mA	4...20 mA	0...10 V	Relay	Miscellaneous						
1	X	X				-	24 V DC	300 V	3-way	S	HART® transparent
1	X	X				-	24 V DC	300 V	3-way	P	HART® transparent
2	X	X				-	24 V DC	300 V	3-way	S	HART® transparent
2	X	X				-	24 V DC	300 V	3-way	P	HART® transparent
1			X			-	24 V DC	300 V	3-way	S	
1			X			-	24 V DC	300 V	3-way	P	
1	X	X	X			Software	24...240 V UC	600 V	3-way	S	
1	X	X				-	input loop	300 V	2-way	S	
2	X	X				-	input loop	300 V	4-way	S	
2		X				-	output loop	300 V	3-way	S	
1		X				-	output loop	300 V	2-way	S	
1		X				-	output loop	300 V	2-way	S	
1		X				-	output loop	300 V	2-way	S	
1		X				-	output loop	300 V	2-way	S	
2		X				-	output loop	300 V	4-way	S	
2	X	X				-	24 V DC	300 V	4-way	S	HART® transparent
2	X	X				-	24 V DC	300 V	4-way	P	HART® transparent
2				X	2 x relay outputs (limit value)	Software, Display	20...264 V UC	300 V	5-way	S	
1	X	X	X		analogue and NPN output, Limit value	Display, Button	24...240 V UC	300 V	3-way	S	
1	X	X	X		analogue and NPN output, Limit value	Display, Button	24...240 V UC	300 V	5-way	P	
1				X	2 x Limit value relay output	Software, Display	9...60 V DC	300 V	5-way	S	
1				X	2 x Limit value relay output	Software, Display	9...60 V DC	300 V	5-way	P	
1				X	2 x Limit value relay output	Software, Display	90...264 V AC	300 V	5-way	S	
1				X	2 x Limit value relay output	Software, Display	90...264 V AC	300 V	5-way	P	
2				X	2 x Limit value relay output	DIP switch, potentiometer	20...240 V UC	300 V	5-way	S	
2				X	2 x Limit value relay output	DIP switch, potentiometer	Input loop	600 V	5-way	S	
1	X	X	X	X	± 10 V, ± 20 mA, Limit value relays	DIP switch, potentiometer	24 V DC	300 V	4-way	S	Power cable can be connected to the terminals
1	X	X	X	X	± 10 V, ± 20 mA, Limit value relays	DIP switch, potentiometer	24 V DC	300 V	4-way	P	Power cable can be connected to the terminals
1	X	X	X	X	± 10 V, ± 20 mA, Limit value relays	DIP switch, potentiometer	24 V DC	300 V	4-way	S	Through hole current converter
1	X	X	X	X	± 10 V, ± 20 mA, Limit value relays	DIP switch, potentiometer	24 V DC	300 V	4-way	S	Through hole current converter
1	X	X	X	X	± 10 V, ± 20 mA, Limit value relays	DIP switch, potentiometer	24 V DC	300 V	4-way	S	Through hole current converter
1				X	Limit value relay output	DIP switch, potentiometer	24 V DC	300 V	3-way	S	Through hole current converter
1	X	X	X	X	± 10 V, ± 20 mA, Limit value relays	DIP switch, potentiometer	24 V DC	300 V	4-way	P	Through hole current converter
1	X	X	X	X	± 10 V, ± 20 mA, Limit value relays	DIP switch, potentiometer	24 V DC	300 V	4-way	P	Through hole current converter
1	X	X	X	X	± 10 V, ± 20 mA, Limit value relays	DIP switch, potentiometer	24 V DC	300 V	4-way	P	Through hole current converter
1				X	Limit value relay output	DIP switch, potentiometer	24 V DC	300 V	3-way	P	Through hole current converter
1	X	X	X		Reset button (TARE)	DIP switch, button	10...60 V DC	300 V	3-way	S	
1	X	X	X		Reset button (TARE)	DIP switch, button	10...60 V DC	300 V	3-way	P	
1	X	X	X		± 10 V, ± 20 mA	Display, DIP switch, button	24 V - 230 V AC/DC	600 V	3-way	S	aktiv or passiv output
1	X	X	X		± 10 V, ± 20 mA	Display, DIP switch, button	24 V - 230 V AC/DC	600 V	3-way	P	aktiv or passiv output
1		X			NPN output, Limit value	Software	output loop	300 V	3-way	S	Output Loop powered
1		X			NPN output, Limit value	Software	output loop	300 V	3-way	P	Output Loop powered
1	X	X	X		0...11V, 0...22mA	DIP switch, button, LED	12...60 V DC	300 V	3-way	S	
1	X	X	X		0...11V, 0...22mA	DIP switch, button, LED	12...60 V DC	300 V	3-way	P	

Connection system: S = screw / Z = tension clamp / P = Push In, ILP = Input Loop Powered, OLP = Output Loop Powered

# ACT20P

D



### Reliable connection

Individually configurable protection against mismatching with release lever



### Simple signal conditioning

Devices configured for converting standard sensor signals to standard DC signals.

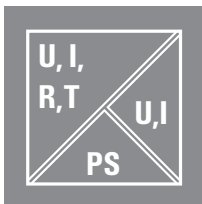

### High level of galvanic isolation

The galvanic isolation of 2 kV (300 V rated voltage) ensures high process reliability

## Signal converters

- Isolation of DC- signals
- Passive transmitter or active current input
- 3-way isolation
- HART® - transparent

## ACT20P-CI-CO

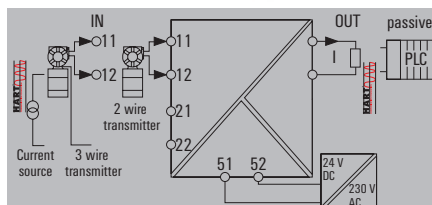

## Technical data

## Input

Input signal  
Input current  
Voltage drop

## Output

Output current

Load impedance current

## General data

Configuration  
Voltage supply  
Accuracy  
Step response time  
Current consumption  
Temperature coefficient

## Insulation coordination

EMC standards  
Insulation voltage  
Test voltage  
Impulse withstand voltage  
Pollution degree  
Overvoltage category

2-/3-wire transmitter, HART signal® bidirectional

0...20 mA, 4...20mA

ca. 3.8 V @  $R_{load} = 0 \Omega$ ; ca. 15 V @  $R_{load} = 600 \Omega$ ; ( $I_{input} = 20 \text{ mA}$ )

0...20 mA (if input: 0...20 mA), 4...20 mA (if input: 4...20 mA), HART® digital signal

$\leq 550 \Omega$

none

20...30 V DC

$< 0.1 \%$  of end value

$\leq 0.5 \text{ ms}$

$\leq 60 \text{ mA}$  (24V power supply, 20mA output)

80 ppm/K

EN 61010-1:2011, UL 61010-1, EN 61326-1

2 kV inputs / outputs / power supply

300 V

4 kV (1.2/50  $\mu\text{s}$ )

2

III

## Dimensions

Clamping range (nominal / min. / max.) mm<sup>2</sup>  
Depth x width x height mm

## Note

## Screw connection

2.5 / 0.5 / 2.5

113.7 / 12.5 / 117.2

## PUSH IN

113.7 / 12.5 / 127.1

## Ordering data

## Connection type

Screw connection  
PUSH IN connection

## Type

ACT20P-CI-CO-S

ACT20P-CI-CO-P

## Qty.

1

1

## Order No.

7760054114

2489680000

## Note

## Accessories

## Note

## Signal converters

### Signal converters

- Isolation of DC- signals
- Passive input
- 2 channels in one module
- 3-way isolation
- HART® - transparent

### ACT20P-2CI-2CO-12

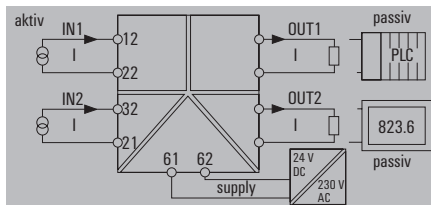

### Technical data

#### Input

Input current  
Voltage drop

#### Output

Output current

Load impedance current

#### General data

Configuration  
Voltage supply  
Accuracy  
Step response time  
Temperature coefficient

#### Insulation coordination

EMC standards  
Insulation voltage  
Test voltage  
Impulse withstand voltage  
Pollution degree  
Overvoltage category

0...20 mA, 4...20mA

≤ 1 V

0...20 mA (if input: 0...20 mA), 4...20 mA (if input: 4...20 mA), HART® digital signal

< 300 Ω, per channel

none

20...30 V DC

< 0.1 % of end value

≤ 0,5 ms

80 ppm/K

EN 61010-1:2011, UL 61010-1, EN 61326-1

2 kV inputs / outputs / power supply

300 V

4 kV (1.2/50 μs)

2

III

#### Dimensions

Clamping range (nominal / min. / max.) mm<sup>2</sup>  
Depth x width x height mm

#### Note

#### Screw connection

#### PUSH IN

2.5 / 0.5 / 2.5  
113.7 / 12.5 / 117.2      113.7 / 12.5 / 127.1

### Ordering data

#### Connection type

Screw connection  
PUSH IN connection

#### Type

#### Qty.

#### Order No.

ACT20P-2CI-2CO-12-S      1      7760054117  
ACT20P-2CI-2CO-12-P      1      2489730000

#### Note

### Accessories

#### Note

## Signal converters

- Isolation of DC signals
- Passive 3-wire transmitter and active current input
- 3-way isolation
- Removable terminals

## ACT20P-CI-V0

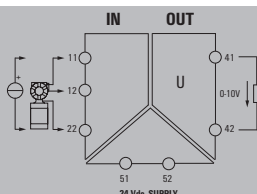

## Technical data

## Input

Input current  
Input signal  
Number of inputs  
Sensor supply

0...20 mA, 4...20mA  
2-/3-wire transmitter, Current source  
1  
> 17 V DC at 20 mA

## Output

Number of outputs  
Output voltage

1  
0...10 V (if input: 0...20 mA), 2...10 V (if input: 4...20 mA)

load impedance voltage

≥ 600 kΩ

## General data

Accuracy  
Configuration  
Current consumption  
Step response time  
Temperature coefficient  
Voltage supply

±0,1 % FSR max., 0,05 % FSR typ.  
none  
≤60 mA (24V power supply, 20mA output)  
≤ 0,5 ms  
80 ppm/K  
20...30 V DC

## Insulation coordination

EMC standards  
Galvanic isolation  
Impulse withstand voltage  
Insulation voltage  
Test voltage  
Overvoltage category  
Standards  
Pollution degree

EN 61326-1  
3-way isolator, between input/output/supply  
4 kV (1.2/50 μs)  
2 kV (Input/Output), 1 min, 50 Hz  
300 V  
III  
EN 61010-1, UL 61010-1  
2

## Dimensions

Clamping range (nominal / min. / max.) mm<sup>2</sup>  
Depth / Width / Height mm

## Screw connection

0.6 / 0.5 / 2.5  
113.7 / 12.5 / 117.2

## PUSH IN

113.7 / 12.5 / 127.1

## Note

## Ordering data

## Connection type

Screw connection  
PUSH IN connection

Type	Qty.	Order No.
ACT20P-CI-V0-S	1	1540010000
ACT20P-CI-V0-P	1	2489740000

## Note

## Accessories

## Note

## Signal converters

## Voltage measurement, 1-phase

- Voltage monitoring of single-phase network up to 500 V AC
- 3 input ranges can be selected
- 2 relays with CO contacts
- Holding function can be activated
- Rotary switch for setting limit values

## ACT20P-VM-A0-S

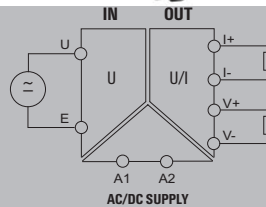

## Technical data

## Input

Input resistance  
Input signal  
Input voltage

Number of inputs

## Output

Load impedance current  
Output current  
Output voltage  
load impedance voltage

## General data

Accuracy  
Configuration  
Power consumption  
Step response time  
Temperature coefficient  
Voltage supply

## Insulation coordination

EMC standards  
Galvanic isolation  
Impulse withstand voltage

Insulation voltage

Rated voltage

Overvoltage category  
Pollution degree  
Standards

1 MΩ±5%

$U_{DC}$ ,  $U_{AC}$  Effective value (sinusoidal only) 40-60 Hz

0...30 V DC, 0...60 V DC, 0...150 V DC, 0...300 V DC, 0...440 V DC,  
0...660 V DC, 0...60 V AC, 0...144 V AC, 0...300 V AC, 0...440 V AC,  
configurable

1

≤ 500 Ω

0...20 mA, 4...20 mA

0...10 V

≥ 10 kΩ

0.5 % FSR

With FDT/DTM software

≤ 100 mA @ 24 VDC, ≤ 120mA @ 24V AC

< 300 ms

≤ 200 ppm/K

24...240 VUC (±10%)

IEC 61000-6 /2, IEC 61000-6-4, IEC 61326-1

3-way isolator, between input / output / supply

4 kV (1.2/50 μs) input - output, 4 kV (1.2/50 μs) input / supply, 2.5  
kV (1.2/50 μs) output / supply

1.5 kV AC output / supply, 2 kV AC input / output, 2 kV AC input /  
supply

600 V input / output, 600 V input / supply, 300 V output / supply

III

2

EN 50178

## Dimensions

Clamping range (nominal / min. / max.) mm<sup>2</sup>  
Depth / Width / Height mm

## Note

## Screw connection

1.5 / 0.5 / 2.5  
114.3 / 22.5 / 119.2

## Ordering data

Type	Qty.	Order No.
ACT20P-VM-A0-S	1	7760054306

## Note

## Accessories

Note CBX 200



**Passive isolators input loop powered**

- Isolation of DC- signals
- Power supply via the input circuit (input loop powered)
- 1 or 2 channels in one module
- 2-way isolation
- Removable terminals

**ACT20P-CI-CO-ILP**

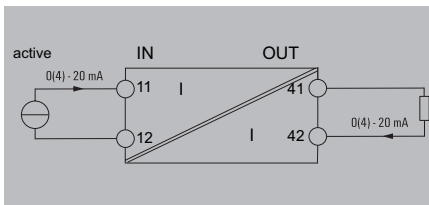

**Technical data**

<b>Input</b>	
Input current	0(4)...20 mA current loop
Voltage drop, current input	3.8 V
Sensor	Current source
Number of inputs	1
<b>Output</b>	
Load impedance current	≤ 600 Ω
Output current	0...20 mA (if input: 0...20 mA), 4...20 mA (if input: 4...20 mA)
Number of outputs	1
<b>General data</b>	
Accuracy	< 0.1 % of end value
Temperature coefficient	≤ 100 ppm/K
Voltage supply	Loop powered, via 4...20 mA input
<b>Insulation coordination</b>	
EMC standards	EN 61010-1:2011, UL 61010-1, IEC61000-6-2, IEC 61000-6-4
Galvanic isolation	2-way isolator
Impulse withstand voltage	4 kV (1.2/50 μs)
Insulation voltage	2 kV inputs / outputs
Rated voltage	300 V
Overvoltage category	III
Pollution degree	2

<b>Dimensions</b>	
Clamping range (nominal / min. / max.)	mm <sup>2</sup>
Depth / Width / Height	mm
<b>Note</b>	
<b>Screw connection</b>	
2.5 / 0.5 / 2.5	
114 / 12.5 / 117.2	

<b>Ordering data</b>	
<b>Channel</b>	
	2-channel
	1-channel
<b>Note</b>	

Type	Qty.	Order No.
ACT20P-2CI-2CO-ILP-S	1	7760054124
ACT20P-CI-CO-ILP-S	1	7760054123

<b>Accessories</b>	
<b>Note</b>	

<b>Note</b>	
-------------	--

## Passive isolators

## Passive isolators output loop powered

- Removable terminals
- Power supply via the output circuit (output loop powered)
- 2-way isolation

## ACT20P-CI-CO-OLP

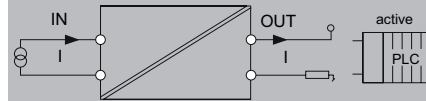

## Technical data

## Input

Number of inputs  
Input voltage

Input current

## Output

Load impedance current  
Output current  
Number of outputs

## General data

Accuracy  
Configuration  
Step response time  
Temperature coefficient  
Voltage supply

## Insulation coordination

EMC standards  
Galvanic isolation  
Impulse withstand voltage  
Insulation voltage  
Rated voltage  
Overvoltage category  
Pollution degree

1

7760054120: 0...5 V DC;  
7760054121: 0...10 V

7760054118: 0...20 mA;  
7760054119: 4...20mA

≤ 600 Ω

4...20 mA, loop-powered

1

&lt; 0.1 % of end value

none

≤ 1 ms

≤ 100 ppm/K

via output current loop, min. 12 V DC/ max. 30 V DC

EN 61010-1:2011, UL 61010-1, IEC61000-6-2, IEC 61000-6-4

2-way isolator

4 kV (1.2/50 μs)

2 kV (Input /Output), 1 min, 50 Hz

300 V

III

2

## Dimensions

Clamping range (nominal / min. / max.) mm<sup>2</sup>  
Depth / Width / Height mm

## Note

## Screw connection

2.5 / 0.5 / 2.5  
114 / 12.5 / 117.2

## Ordering data

Input voltage	
	0...10 V
	0...5 V
Input current	
	0...20 mA
	4...20 mA

## Note

Type	Qty.	Order No.
ACT20P-VI-CO-OLP-S	1	7760054121
ACT20P-VI1-CO-OLP-S	1	7760054120
ACT20P-CI1-CO-OLP-S	1	7760054118
ACT20P-CI2-CO-OLP-S	1	7760054119

## Note

**Passive isolators output loop powered**

- Removable terminals
- Doubling of the signal
- Power supply via the output circuit (output loop powered)
- 3-way isolation

**ACT20P-CI-2CO-OLP**

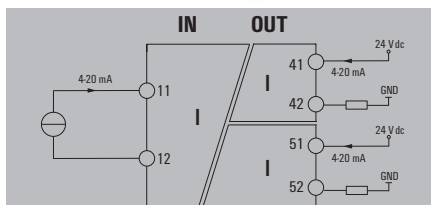

**Technical data**

<b>Input</b>	
Number of inputs	1
Input current	4...20mA
Sensor	Current source
<b>Output</b>	
Number of outputs	2
Output current	4...20 mA, loop-powered
Load impedance current	$R_L = (U_S - 12 \text{ V}) / 20 \pm 20 \text{ mA}$ , e.g. 600 Ω at 24 V
<b>General data</b>	
Configuration	none
Galvanic isolation	3-way isolator
Accuracy	< 0.1 % of end value
Temperature coefficient	≤ 100 ppm/K
Voltage supply	via output current loop, min. 12 V DC/ max. 30 V DC
<b>Insulation coordination</b>	
EMC standards	EN 61010-1:2011, UL 61010-1, IEC61000-6-2, IEC 61000-6-4
Insulation voltage	2 kV (Input /Output), 1 min, 50 Hz
Rated voltage	300 V
Impulse withstand voltage	4 kV (1.2/50 μs)
Pollution degree	2
Overvoltage category	III

<b>Dimensions</b>	
Clamping range (nominal / min. / max.)	mm <sup>2</sup>
Depth / Width / Height	mm
<b>Note</b>	
<b>Screw connection</b>	
2.5 / 0.5 / 2.5	
114 / 12.5 / 117.2	
<b>Note</b>	

<b>Ordering data</b>	
Input current	4...20 mA
<b>Note</b>	

<b>Accessories</b>		
<b>Note</b>		

Type	Qty.	Order No.
ACT20P-CI-2CO-OLP-S	1	7760054122

<b>Note</b>	
-------------	--

<b>Note</b>	
-------------	--

## Signal splitters

### Signal splitters

- Isolation and splitting of DC signals
- Passive transmitter or active current input
- 3-way isolation
- HART® - transparent

### ACT20P-CI-2CO

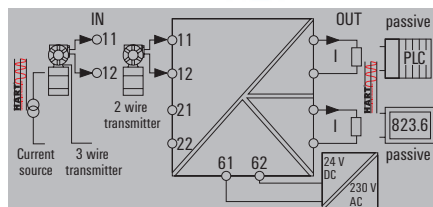

### Technical data

<b>Input</b>	
Input signal	2-/3-wire transmitter, HART signal® bidirectional
Input current	0...20 mA, 4...20mA
Voltage drop	ca. 3.8 V @ $R_{load} = 0 \Omega$ ; ca. 15 V @ $R_{load} = 600 \Omega$ ; ( $I_{input} = 20 \text{ mA}$ )
<b>Output</b>	
Output current	0...20 mA (if input: 0...20 mA), 4...20 mA (if input: 4...20 mA), HART® digital signal
Load impedance current	< 300 $\Omega$
<b>General data</b>	
Configuration	none
Voltage supply	20...30 V DC
Accuracy	< 0.1 % of end value
Step response time	$\leq 0,5 \text{ ms}$
Temperature coefficient	80 ppm/K
<b>Insulation coordination</b>	
EMC standards	EN 61010-1:2011, UL 61010-1, EN 61326-1
Insulation voltage	2 kV inputs / outputs / power supply
Test voltage	300 V
Impulse withstand voltage	4 kV (1.2/50 $\mu\text{s}$ )
Pollution degree	2
Overvoltage category	III

<b>Dimensions</b>	
Clamping range (nominal / min. / max.)	mm <sup>2</sup>
Depth x width x height	mm
<b>Note</b>	
<b>Ordering data</b>	
<b>Connection type</b>	
Screw connection	
PUSH IN connection	
<b>Note</b>	
<b>Accessories</b>	
<b>Note</b>	

<b>Dimensions</b>	
Clamping range (nominal / min. / max.)	mm <sup>2</sup>
Depth x width x height	mm
<b>Note</b>	

<b>Screw connection</b>		<b>PUSH IN</b>	
2.5 / 0.5 / 2.5		113.7 / 12.5 / 127.1	
113.7 / 12.5 / 117.2		113.7 / 12.5 / 127.1	

### Ordering data

<b>Connection type</b>	
Screw connection	
PUSH IN connection	

<b>Type</b>	<b>Qty.</b>	<b>Order No.</b>
ACT20P-CI-2CO-S	1	7760054115
ACT20P-CI-2CO-P	1	2489710000

<b>Note</b>
-------------

### Accessories

<b>Note</b>
-------------

**Temperature limit-value monitoring**

- Temperature monitoring of PT100 sensors or PTC
- Temperature range can be selected
- 2 relays with CO contacts
- Limit value can be set with software configuration

**ACT20P-TMR-RTI-S**

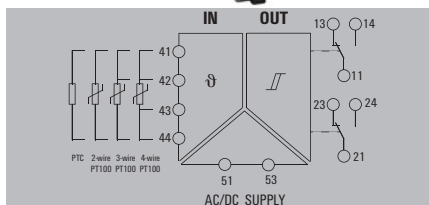

**Technical data**

<b>Input</b>	
Number of inputs	1
Sensor	PT100 / 2-/3-/4-wire, PTC: 0...4 kΩ
Temperature input range	Configurable, PT100: -200°C...850 °C
<b>Output (digital)</b>	
Number of digital outputs	2
Type	2 x 1 - or 1 x 2 changeover contact relay
Alarm function	Alarm range: -200...850 °C, Top and bottom limit values, window range, Hysteresis: 2 °C (adjustable), Alarm delay: 0...10 s
Rated switching current	5 A
Max. switching voltage, AC	250 V
Max. switching voltage, DC	30 V
<b>General data</b>	
Configuration	With FDT/DTM software
Accuracy	0.2% FSR, ≤ 2 °C (PT100), ≤ 8 Ω (PTC)
Power consumption	≤ 100 mA @ 24 VDC, ≤ 120mA @ 24V AC
Step response time	≤ 500 ms
Temperature coefficient	≤ 100 ppm/K
Voltage supply	20...264 VUC
<b>Insulation coordination</b>	
EMC standards	IEC 61326-1
Galvanic isolation	3-way isolator, between input/output/supply
Insulation voltage	2 kV (Input/Output), 1 min, 50 Hz
Impulse withstand voltage	4 kV (1.2/50 μs)
Pollution degree	2
Overvoltage category	III
Rated voltage	300 V
Standards	IEC 61010-1

<b>Dimensions</b>		
Clamping range (nominal / min. / max.)	mm <sup>2</sup>	1.5 / 0.5 / 2.5
Depth / Width / Height	mm	114.3 / 22.5 / 119.2
<b>Note</b>		

**Ordering data**

Type	Qty.	Order No.
ACT20P-TMR-RTI-S	1	7760054305

<b>Note</b>	
-------------	--

**Accessories**

<b>Note</b>	
-------------	--

## Temperature transducers

## Temperature transducer with limit relay

- Configurable from buttons and display
- Monitoring of resistance changes (e.g.: motor winding / heating resistors)
- Analog and digital output
- Removable terminals

## ACT20P-PRO-RTCI-AO-DO

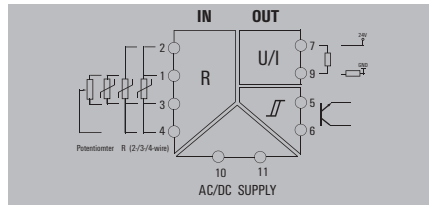

## Technical data

## Input

Number of inputs  
Potentiometer  
Resistance  
Sensor

## Output (digital)

Alarm function

Rated switching voltage  
Type

## Output (analogue)

Output current

Output voltage

Load resistance current

## General data

Accuracy  
Configuration  
Step response time  
Temperature coefficient  
Voltage supply

## Insulation coordination

EMC standards  
Impulse withstand voltage  
Galvanic isolation  
Insulation voltage  
Rated voltage  
Overvoltage category

## Dimensions

Clamping range (nominal / min. / max.) mm<sup>2</sup>  
Depth / Width / Height mm

## Note

## Ordering data

## Connection type

Screw connection  
PUSH IN connection

## Note

## Accessories

## Note

1
10...150 kΩ
0...15 kΩ
PT100 / 2-/3-/4-wire, PT200, PT500, N50, N100, P 1K, N 1K, KT16, KT81, KT82, KT83, KT84, ST13, ST20
configurable, Top and bottom limit values, window range, Short circuit at input, Alarm delay: 0...10 s, Hysteresis 5% / 10%
24 VDC ±30%
NPN-Transistor, Switching frequency 5 kHz
configurable, 0(4)...20 mA, -20...+20 mA, ± 10mA, upscale (23 mA), downscale (3,5 mA)
configurable, 0(1)...5 V, 0(2)...10 V, downscale (0 V), upscale (11 V), -5...+5 V, -10...+10 V
≤ 600 Ω
< ±0.1 % of span, ≤ 2 °C (PT100)
with push-buttons and display
2- / 4- wire: 320 ms; 3- wire / Pot: 640 ms
≤ 0.02 % / °C, ≤ 200 ppm/K
24...230 V DC ±15%, 24...230 V AC ±15% @48...62 Hz
EN 61326-1
5 kV (1.2/50 μs)
4-way isolator, between input / output / supply
4 kV <sub>eff</sub> / 1 min.
600 V
II

## Screw connection

## PUSH IN

2.5 / 0.5 / 2.5  
113.7 / 12.5 / 119.2      113.7 / 12.5 / 127.1

Type	Qty.	Order No.
ACT20P-PRO-RTCI-AO-DO-S	1	2448100000
ACT20P-PRO-RTCI-AO-DO-P	1	2448110000

### Universal limit-value monitoring

- Universally configurable input for temperature, voltage, current, potentiometer, resistance
- 2 independent relay outputs with multiple limit value functions: window alarm, upper/lower limits, hysteresis, delay, etc.
- Configuration on the device from 7-segment display or via FDT/DTM software
- External power supply DC or AC

### ACT20P-UI-2RCO-DC-S

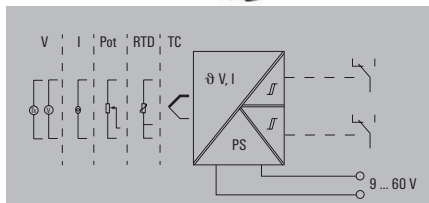

### Technical data

<b>Input</b>	
Number of inputs	1
Sensor	Thermocouples: B, E, J, K, L, N, R, S, T, U, RTD: PT100, PT200, PT1000, Ni120, Cu10, 2-/3-/4-wire
Temperature input range	B: +100...+1820 °C, E: -270...+1000 °C, J: (-210...+1200 °C), K: -270...+1372 °C, L: +100...+900 °C, N: (-180...+1300 °C), R: -50...+1768 °C, S: -50...+1768 °C, T: -270...+400 °C, U: -200...+600 °C
<b>Output (digital)</b>	
Alarm function	configurable, Top and bottom limit values, window range, Alarm delay: 0...99 s, Hysteresis adjustable, auto / manual reset
Rated switching current	200mA @ 110Vdc, 6A @ 24Vdc / 240Vac
Number of digital outputs	2
Type	2 CO contacts, normal / inverse adjustment, Switching frequency 20 Hz
Max. switching voltage, AC	240 V
<b>General data</b>	
Accuracy	< 0.1 % of measuring range
Configuration	With FDT/DTM software, or via 7-segment display, push-buttons and rotary encoder on the device itself
Step response time	450 ms
Power consumption	≤ 3,5 W
Temperature coefficient	< 0.02 °C of measuring range / °C
Voltage supply	9...60 V DC
<b>Insulation coordination</b>	
Standards	DIN EN 61010-1
Pollution degree	2
Ambient temperature (operational)	-20 °C...70 °C

<b>Dimensions</b>	
Clamping range (nominal / min. / max.)	mm <sup>2</sup>
Depth / Width / Height	mm
<b>Note</b>	

<b>Screw connection</b>	<b>PUSH IN</b>
2.5 / 0.5 / 2.5	
113.6 / 22.5 / 119.2	113.6 / 22.5 / 127.1

### Ordering data

<b>DC supply voltage</b>	
	Screw connection
	PUSH IN connection
<b>AC supply voltage</b>	
	Screw connection
	PUSH IN connection

Type	Qty.	Order No.
ACT20P-UI-2RCO-DC-S	1	7940045760
ACT20P-UI-2RCO-DC-P	1	2456840000
ACT20P-UI-2RCO-AC-S	1	1238910000
ACT20P-UI-2RCO-AC-P	1	2495690000

<b>Note</b>
-------------

## Measuring and monitoring relays

## Voltage monitoring, 1-phase

- Monitoring of single-phase systems up to 400 V AC/DC
- 3 input ranges can be selected
- 2 relays with CO contacts
- Holding function can be activated
- Rotary switch for setting limit values

## ACT20P-VMR-1PH-H

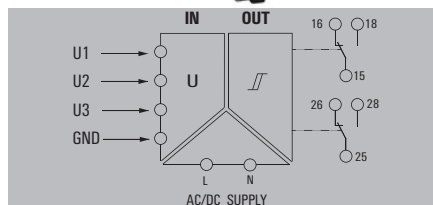

## Technical data

## Input

Number of inputs  
Input voltage

Input measurement range  
Input frequency  
Input resistance, voltage

## Output (digital)

Number of digital outputs  
Type  
Alarm function

Rated switching current  
Max. switching voltage, AC  
Max. switching voltage, DC

## General data

Configuration  
Accuracy  
Measurement calibration  
Power consumption  
Step response time  
Temperature coefficient  
Repeat accuracy  
Voltage supply

## Insulation coordination

EMC standards  
Galvanic isolation  
Rated voltage  
  
Insulation voltage  
Impulse withstand voltage

Pollution degree  
Overvoltage category  
Standards

## Dimensions

Clamping range (nominal / min. / max.) mm<sup>2</sup>  
Depth / Width / Height mm

## Note

## Ordering data

## Note

## Accessories

## Note

1
Channel 1: (U1-E): 110V AC/DC, Channel 2: (U2-E): 240V AC/DC, Channel 3 1: (U3-E): 400V AC/DC
50...120% $U_{\text{rated voltage}}$
40...60 Hz, DC
1 M $\Omega$ ±5%
2
2 x 1 - or 1 x 2 changeover contact relay, Relay polarity can be inverted Top and bottom limit values, window range, Holding function can be activated, Alarm delay: 0...10 s
5 A
250 V
30 V
DIP switch and potentiometer
3% * $U_{\text{rated voltage}}$
max: 70...120% * $U_{\text{rated voltage}}$ , min: 50...100% * $U_{\text{rated voltage}}$
≤ 100 mA @ 24 VDC, ≤ 120mA @ 24V AC
< 220 ms (10...90 %)
350 ppm/K
2% * $U_{\text{rated voltage}}$
24...240 VUC ±10%
IEC 61326-1
3-way isolator, between input / output / supply
300 VAC (output 1 - output 2), 300 VAC (supply-output), 500 VAC (supply-input, input-output)
2.5 kV (input / output), 2 kV input / output/ power supply
Supply/output: 4 kV; input/output, input/output: 6 kV, 1.2/50 $\mu$ s
2
III
EN 50178
Screw connection
1.5 / 0.5 / 2.5
114.3 / 22.5 / 117

Type	Qty.	Order No.
ACT20P-VMR-1PH-H-S	1	7760054164



**Voltage monitoring, 3-phase**

- Voltage monitoring of single-phase network up to 500 V AC
- 3 input ranges can be selected
- 2 relays with CO contacts
- Holding function can be activated
- Rotary switch for setting limit values

**ACT20P-VMR-3PH-ILP-H**

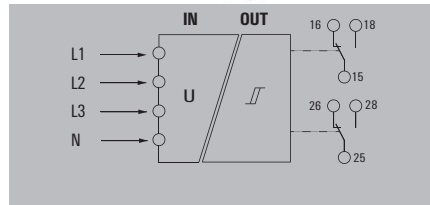

**Technical data**

Input	
Number of inputs	1
Input frequency	40..60 Hz
Input measurement range	200..480 VAC
Input voltage	180...500 VAC
Input resistance, voltage	≥1,8MΩ
Output (digital)	
Number of digital outputs	2
Type	2 x 1 - or 1 x 2 changeover contact relay, Relay polarity can be inverted
Alarm function	Top and bottom limit values, window range, Holding function can be activated, Phase error, Phase sequence, Asymmetry, Alarm delay: 0...10 s
Rated switching current	5 A
Max. switching voltage, AC	250 V
Max. switching voltage, DC	30 V
General data	
Configuration	DIP switch and potentiometer
Accuracy	3 % *U <sub>rated voltage</sub>
Measurement calibration	max: 70...120% *U <sub>rated voltage</sub> , min: 50...100% *U <sub>rated voltage</sub>
Unbalanced	Hysteresis: 5%, Phase imbalance in range of adjustment: 5...25%, OFF
Repeat accuracy	2 % *U <sub>rated voltage</sub>
Step response time	≤ 100 ms
Temperature coefficient	350 ppm/K
Voltage supply	supplied from voltage measurement inputs
Insulation coordination	
EMC standards	EN 61326-1
Galvanic isolation	2-way isolator, between input/output
Rated voltage	600 VAC (input - output), 300 VAC (output 1 - output 2)
Insulation voltage	2.5 kV (input / output)
Impulse withstand voltage	6 kV (input - output), 4 kV (output 1- output 2), 1.2/50 μs
Pollution degree	2
Overvoltage category	III
Standards	EN 50178
Dimensions	
Clamping range (nominal / min. / max.)	mm <sup>2</sup> 1.5 / 0.5 / 2.5
Depth / Width / Height	mm 114.3 / 22.5 / 117
Note	

Screw connection		
Type	Qty.	Order No.
ACT20P-VMR-3PH-ILP-H-S	1	7760054165

**Ordering data**

Note

**Accessories**

Note	
------	--

## Current measuring transducers

### Current measuring transducer

- Measuring and monitoring AC/DC currents
- Input/output electrically isolated
- Input and output ranges are adjustable
- Measurement range extension via external current transformer
- Relay output for limit value alarm with switching threshold, delay, hysteresis

### ACT20P-CML-10-AO-RC-S

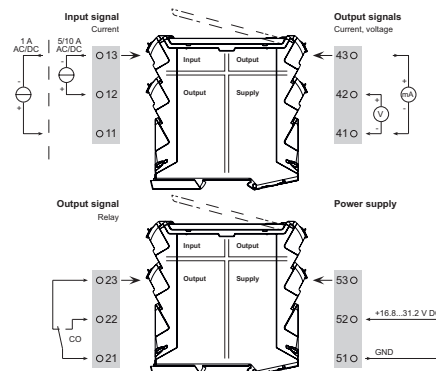

D

### Technical data

<b>Input</b>	
Number of inputs	1
Input signal	Power cable can be connected to the terminals
Input frequency	AC: 15...400 Hz (true root mean square), AC: 50 Hz (arithmetic average)
Input measurement range	configurable, 0...1/5/10 A AC (RMS) or DC
<b>Output (digital)</b>	
Alarm function	Surge current, Under-current, Alarm delay: 0...10 s
Rated switching current	2 A
Number of digital outputs	1
Type	Relay, 1 CO contact, normal / inverse adjustment
Max. switching voltage, AC	250 V
<b>Output (analogue)</b>	
Load resistance current	≤ 600 Ω
Load resistance voltage	≥ 10 kΩ
Number of analogue outputs	1
Output current	Adjustable, 0...20 mA, 4...20 mA, -20...+20 mA
Output voltage	Adjustable, 0...10 V, 2...10 V, 0...5 V, 1...5 V, -5...+5 V, -10...+10 V
<b>General data</b>	
Accuracy	≤ ±0.3 % @ 1 A/5 A, ≤ ±0.6 % @ 10 A
Configuration	DIP switch and potentiometer
Step response time	≤ 300 ms (RMS), ≤ 60 ms (AA)
Power consumption, max.	2.2 W
Temperature coefficient	≤ ±100 ppm/K @ -25...+55 °C, ≤ ±200 ppm/K @ +55...+70 °C
Voltage supply	16,8 V...31,2 V
<b>Insulation coordination</b>	
EMC standards	IEC 61326-1, IEC 61010-2-201
Impulse withstand voltage	6 kV (1.2/50 μs)
Galvanic isolation	4-way isolator, between input/output/supply/relay
Insulation voltage	4 kV <sub>eff</sub> / 1 min.
Test voltage	4 kV
Overtoltage category	III

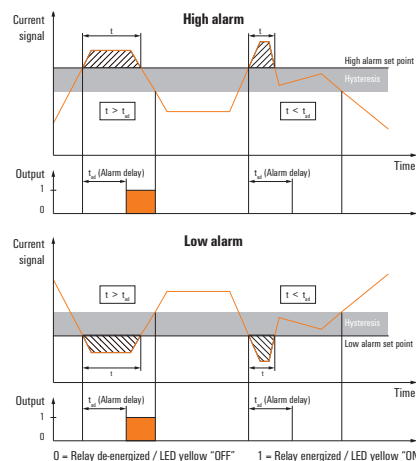

<b>Dimensions</b>	
Clamping range (nominal / min. / max.)	mm <sup>2</sup>
Depth / Width / Height	mm
<b>Note</b>	

<b>Screw connection</b>	<b>PUSH IN</b>
1.5 / 0.5 / 2.5	
113.6 / 17.5 / 119.2	114 / 17.5 / 127.1
<b>Note</b>	

### Ordering data

<b>Connection type</b>	
Screw connection	
PUSH IN connection	
<b>Note</b>	

<b>Type</b>	<b>Qty.</b>	<b>Order No.</b>
ACT20P-CML-10-AO-RC-S	1	2044850000
ACT20P-CML-10-AO-RC-P	1	2489910000
<b>Note</b>		

### Accessories

<b>Note</b>	
-------------	--



**Current measuring transducer**

- Measuring and monitoring of AC/DC current
- Input/output electrically isolated
- Input and output ranges are adjustable
- Contact-free through-hole technology
- Relay output for limit value alarm with switching threshold, delay, hysteresis

**ACT20P-CMT**

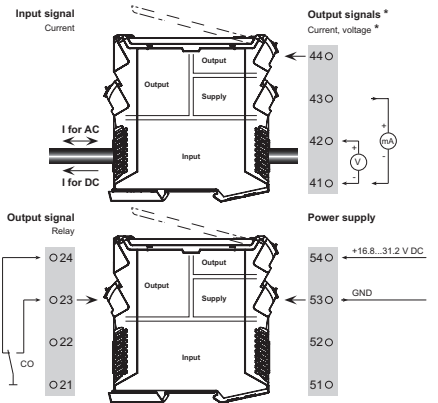
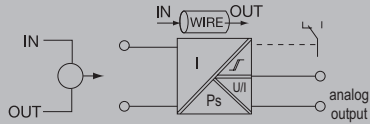

**Technical data**

<b>Input</b>	
Input measurement range	configurable, 0...5/10 A AC (RMS) or DC
Input signal	Current-carrying cable in feed-through hole, Diameter 10.5 mm
Input frequency	AC: 15...700 Hz (true root mean square), AC: 50 Hz (arithmetic average)
<b>Output (analogue)</b>	
Output voltage	Adjustable, 0...10 V, 2...10 V, 0...5 V, 1...5 V, -5...+5 V, -10...+10 V
Output current	Adjustable, 0...20 mA, 4...20 mA, -20...+20 mA
Load resistance voltage	≥ 10 kΩ
Load resistance current	≤ 600 Ω
<b>Output (digital)</b>	
Type	Relay, 1 CO contact, normal / inverse adjustment
Alarm function	Surge current, Under-current, Alarm delay: 0...10 s, Hysteresis 5% / 10%
Rated switching current	6 A
Max. switching voltage, AC	250 V
<b>General data</b>	
Galvanic isolation	4-way isolator, between input / output / supply / relay
Accuracy	< 0.75 % FSR
Configuration	DIP switch and potentiometer
Step response time	≤ 300 ms (RMS), ≤ 60 ms (AA)
Temperature coefficient	≤ ±100 ppm/K @ -25...+55 °C, ≤ ±200 ppm/K @ +55...+70 °C
Voltage supply	16.8 V...31.2 V
<b>Insulation coordination</b>	
Rated voltage	300 V AC <sub>rms</sub>
Standards	IEC 61010-1:2010, 3rd Edition, IEC 61010-2:2013, 1st Edition, EN 61326-1
Impulse withstand voltage	6.4 kV (1.2/50 μs)
Test voltage	4 kV
Pollution degree	2
Overvoltage category	III
<b>Dimensions</b>	
Clamping range (nominal / min. / max.)	mm <sup>2</sup>
Depth / Width / Height	mm
<b>Note</b>	

<b>Input</b>	
Input measurement range	configurable, 0...5/10 A AC (RMS) or DC
Input signal	Current-carrying cable in feed-through hole, Diameter 10.5 mm
Input frequency	AC: 15...700 Hz (true root mean square), AC: 50 Hz (arithmetic average)
<b>Output (analogue)</b>	
Output voltage	Adjustable, 0...10 V, 2...10 V, 0...5 V, 1...5 V, -5...+5 V, -10...+10 V
Output current	Adjustable, 0...20 mA, 4...20 mA, -20...+20 mA
Load resistance voltage	≥ 10 kΩ
Load resistance current	≤ 600 Ω
<b>Output (digital)</b>	
Type	Relay, 1 CO contact, normal / inverse adjustment
Alarm function	Surge current, Under-current, Alarm delay: 0...10 s, Hysteresis 5% / 10%
Rated switching current	6 A
Max. switching voltage, AC	250 V
<b>General data</b>	
Galvanic isolation	4-way isolator, between input / output / supply / relay
Accuracy	< 0.75 % FSR
Configuration	DIP switch and potentiometer
Step response time	≤ 300 ms (RMS), ≤ 60 ms (AA)
Temperature coefficient	≤ ±100 ppm/K @ -25...+55 °C, ≤ ±200 ppm/K @ +55...+70 °C
Voltage supply	16.8 V...31.2 V
<b>Insulation coordination</b>	
Rated voltage	300 V AC <sub>rms</sub>
Standards	IEC 61010-1:2010, 3rd Edition, IEC 61010-2:2013, 1st Edition, EN 61326-1
Impulse withstand voltage	6.4 kV (1.2/50 μs)
Test voltage	4 kV
Pollution degree	2
Overvoltage category	III
<b>Screw connection</b>	<b>PUSH IN</b>
	1.5 / 0.5 / 2.5
	113.6 / 22.5 / 119.2      114 / 22.8 / 127.1

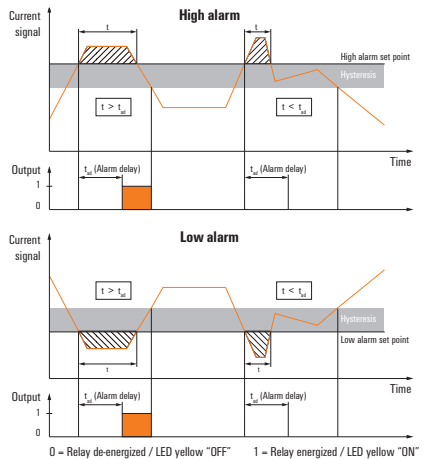

<b>Current input range</b>	DIP switch S1	<b>Output range</b>	DIP switch S2
0...5 A 1)	1 2 3 4 5 6 7 8	0...10 V	1 2 3 4 5 6 7 8
0...10 A	1 2 3 4 5 6 7 8	2...10 V	1 2 3 4 5 6 7 8
0...20 A	1 2 3 4 5 6 7 8	0...5 V	1 2 3 4 5 6 7 8
0...25 A 2)	1 2 3 4 5 6 7 8	1...5 V	1 2 3 4 5 6 7 8
0...30 A	1 2 3 4 5 6 7 8	-5...+5 V	1 2 3 4 5 6 7 8
0...40 A	1 2 3 4 5 6 7 8	-10...+10 V	1 2 3 4 5 6 7 8
0...50 A 3)	1 2 3 4 5 6 7 8	0...20 mA	1 2 3 4 5 6 7 8
0...60 A	1 2 3 4 5 6 7 8	4...20 mA	1 2 3 4 5 6 7 8
		-20...+20 mA	1 2 3 4 5 6 7 8
<b>Measuring method</b>	1 2 3 4 5 6 7 8	<b>Alarm relay action</b>	1 2 3 4 5 6 7 8
True RMS	1 2 3 4 5 6 7 8	Energized	1 2 3 4 5 6 7 8
Arithmetic average	1 2 3 4 5 6 7 8	De-energized	1 2 3 4 5 6 7 8
<b>Alarm delay time</b>	1 2 3 4 5 6 7 8	<b>Alarm hysteresis</b>	1 2 3 4 5 6 7 8
0 s	1 2 3 4 5 6 7 8	5 %	1 2 3 4 5 6 7 8
2 s	1 2 3 4 5 6 7 8	10 %	1 2 3 4 5 6 7 8
5 s	1 2 3 4 5 6 7 8	<b>Alarm type</b>	1 2 3 4 5 6 7 8
10 s	1 2 3 4 5 6 7 8	High alarm	1 2 3 4 5 6 7 8
<b>Measuring range monitoring</b>	1 2 3 4 5 6 7 8	Low alarm	1 2 3 4 5 6 7 8
Yes	1 2 3 4 5 6 7 8		
No	1 2 3 4 5 6 7 8		
<b>Output error action</b>	1 2 3 4 5 6 7 8		
Upscale	1 2 3 4 5 6 7 8		
Downscale	1 2 3 4 5 6 7 8		
<b>Transfer function</b>	1 2 3 4 5 6 7 8		
Normal	1 2 3 4 5 6 7 8		
Inverse	1 2 3 4 5 6 7 8		

■ ON  
 1) ACT20P-CMT-10-AD-RC-S  
 2) ACT20P-CMT-30-AD-RC-S  
 3) ACT20P-CMT-60-AD-RC-S, ACT20P-CMT-60-RC-S

**Ordering data**

<b>Connection type</b>	
Input measurement range 0...5/10 A	Screw connection
Input measurement range 0...20/25/30 A	Screw connection
Input measurement range 0...40/50/60 A	Screw connection
Input measurement range: 0 to 40/50/60 A	Screw connection
Input measurement range 0...5/10 A	PUSH IN connection
Input measurement range 0...20/25/30 A	PUSH IN connection
Input measurement range 0...40/50/60 A	PUSH IN connection
Input measurement range: 0 to 40/50/60 A	PUSH IN connection
<b>Note</b>	

<b>Type</b>	<b>Qty.</b>	<b>Order No.</b>
ACT20P-CMT-10-AD-RC-S	1	1510470000
ACT20P-CMT-30-AD-RC-S	1	1510540000
ACT20P-CMT-60-AD-RC-S	1	1510440000
ACT20P-CMT-60-RC-S	1	1510390000
ACT20P-CMT-10-AD-RC-P	1	1510330000
ACT20P-CMT-30-AD-RC-P	1	1510320000
ACT20P-CMT-60-AD-RC-P	1	1510290000
ACT20P-CMT-60-RC-P	1	1510280000

## Bridge measuring transducers

### Configurable

Bridge measuring transducer for reading from load cells

- 3-way isolation
- Supplies measuring bridges up to 4 x 350  $\Omega$
- Simple calibration of the tare weight using external switch or PLC input
- Input and output ranges adjustable via DIP switch

### ACT20P-BRIDGE-S

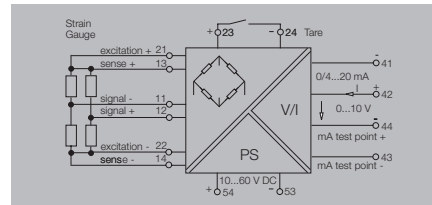

### Technical data

Input	
Bridge sensitivity	1.0 mV / V to 5.0 mV / V
Input measurement range	$\pm 10 \text{ mV} / \pm 20 \text{ mV} / \pm 30 \text{ mV} / \pm 50 \text{ mV}$ (adjustable)
Sensor	Resistance measuring bridge, Total resistance of all parallel resistance measuring bridges: min. 87 $\Omega$
Sensor supply	120 mA @ 10 V (= 4 x 350 $\Omega$ bridge resistors)
Bridge supply voltage	5 V or 10 V
Output	
Type	Voltage and current output (configurable)
Output voltage / Output current	0...11 V (adjustable) / 0...22 mA (adjustable)
Load impedance, voltage/current	600 $\Omega$ / $\leq 600 \Omega$
General data	
Configuration	DIP switch and button
Voltage supply	10...60 V DC
Power consumption	3 W @ 24 V DC
Linearity	Typically $\pm 0.05 \%$ of signal range
Repeat accuracy	$\pm 0.05 \%$ of final value
Humidity	10...90 %, no condensation
Temperature coefficient	typ. 0.005 % / $^{\circ}\text{C}$
Long-term drift	0.1 % / 10.000 h
Step response time	< 400 ms (10...90 %)
Ambient temperature	-40 $^{\circ}\text{C}$ ...70 $^{\circ}\text{C}$
Approvals	CE, EAC
Insulation coordination	
Standards	DIN EN 61010-1, DIN EN 61000-4-2
EMC standards	EN 61326
Rated voltage	300 V <sub>eff</sub>
Pollution degree	2
Overvoltage category	III
Insulation voltage	5.7 kV (input / output, input / supply)

Dimensions	
Clamping range (nominal / min. / max.)	mm <sup>2</sup>
Depth x width x height	mm
Note	

### Ordering data

Connection type	
Screw connection	
PUSH IN connection	
Note	

### Accessories

Note	
------	--

Screw connection	PUSH IN
2.5 / 0.5 / 2.5	
113.6 / 22.5 / 119.2	113.6 / 22.5 / 127.1
Note	

Type	Qty.	Order No.
ACT20P-BRIDGE-S	1	1067250000
ACT20P-BRIDGE-P	1	2456820000
Note		

### Front panel DIP Switch settings

Switch	Action if On	Action if Off
1	10 V Excitation	5 V Excitation
2	mA Output	Voltage Output
3	10 mV Span	Turn off for other ranges
4	20 mV Span	
5	30 mV Span	
6	50 mV Span	
7	4-wire Measurement	6-wire Measurement
8		

### Connections

Terminal	Signal	
11	Signal -	Input signal
12	Signal +	
13	Sense +	Bridge Excitation Voltage
14	Sense -	
21	Excitation +	
22	Excitation -	
23	Tare +	External Tare switch
24	Tare -	
41	mA Output -	Output signal
42	Output +	
43	mA-Test Point -	
44	Voltage Output -	
44	mA-Test Point +	Power Supply
54	+	
53	-	

### Universal DC isolation amplifier

- Universally configurable input and output for voltage/ current
- Active or passive output
- Universal voltage supply 24...230 V AC/DC
- 3-way isolation
- Convenient configuration on the device with DIP switches or by means of clear-text display + buttons, without reference source.

### ACT20P-PRO DCDC II

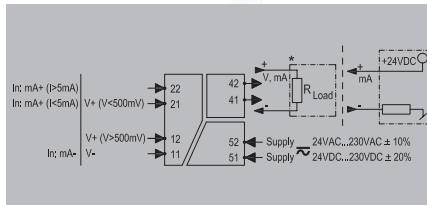

### Technical data

Input	
Input voltage	configurable, ±40 mV...±300 V, Measuring range. min 40 mV
Input current	configurable, ± 0.1mA...± 100 mA
Input resistance, current	< 5 mA: approx. 100 Ω; >5 mA: approx. 5 Ω
Input resistance, voltage	approx. 1 MΩ
Output	
Output voltage	Adjustable, 0...±10 V
Output current	Adjustable, 0...±20 mA
load impedance voltage	≥ 1 kΩ
Load impedance current	≤ 600 Ω
Offset voltage	< 10 mV
Cut-off frequency (-3 dB)	> 10 kHz/ < 10 Hz
General data	
Galvanic isolation	3-way isolator, between input/output/supply
Accuracy	< 0.05 % of measuring range
Temperature coefficient	≤0,01% des Messbereichs°C
Configuration	DIP switch, or via display and push-buttons
Power consumption	≤2.3 W
Step response time	≤50 μs
Voltage supply	24...230 V DC ±20 %, 24...230 V AC ±10 % @ 48...62 Hz
Insulation coordination	
Rated voltage	600 V
Standards	EN 60079-0, EN 60079-15, EN 61010-1, EN 61140, EN 61326-1, UL 61010-1, SN29500 for MTBF
Insulation voltage	4 kV <sub>eff</sub> , input/output/power supply
Impulse withstand voltage	5 kV (1.2/50 μs)
Pollution degree	2
Overvoltage category	II

Dimensions		
Clamping range (nominal / min. / max.)	mm <sup>2</sup>	
Length x width x height	mm	
Note		
Screw connection		
	PUSH IN	
	2.5 / 0.5 / 2.5	
	12.5 / 119.2      12.5 / 127.1	
Ordering data		
Connection type		
	Screw connection	
	PUSH IN connection	
Note		
Accessories		
Note		

Dimensions	
Clamping range (nominal / min. / max.)	mm <sup>2</sup>
Length x width x height	mm
Note	

### Ordering data

Connection type		
	Screw connection	
	PUSH IN connection	
Note		

### Accessories

Note		

Screw connection		
	PUSH IN	
	2.5 / 0.5 / 2.5	
	12.5 / 119.2	12.5 / 127.1
Ordering data		
Type	Qty.	Order No.
ACT20P-PRO DCDC II-S	1	1481970000
ACT20P-PRO DCDC II-P	1	1481960000
Note		
Accessories		
Note		

## Universal measurement transducers

### Universal converter with digital output

- Independent of external supply thanks to output loop-powered supply
- All-purpose usage thanks to versatile input functions
- Simple software configuration
- Digital output for versatile limit value setting

### ACT20P-UI-A0-DO-LP

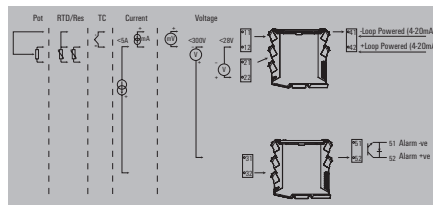

### Technical data

#### Input

Sensor

Input voltage

Input current

Potentiometer

#### Output (analogue)

Output current

Signal output

#### Output (digital)

Alarm function

Hysteresis

Type

Rated switching voltage

Rated switching current

#### General data

Galvanic isolation

Accuracy

Configuration

Step response time

Voltage supply

#### Insulation coordination

Rated voltage

Standards

Insulation voltage

Impulse withstand voltage

Pollution degree

Overvoltage category

#### Dimensions

Clamping range (nominal / min. / max.) mm<sup>2</sup>

Depth / Width / Height

#### Note

### Ordering data

#### Connection type

Screw connection

PUSH IN connection

#### Note

### Accessories

#### Note

PT100 (2-/3- wire), PT1000 (2-/3- wire), PT200, N120, Cu 10, Thermocouples: B, E, J, K, L, N, R, S, T, U

configurable, -150...+150 mV DC (min. measurement range 15 mV), -600...+600 mV DC (min. measurement range 50 mV), ± 12 V DC (min. measurement range 1 V), ± 28 V DC (min. measurement range 2 V), ± 300 V DC (min. measurement range 100 V), 0...1 V AC (min. measurement range 300 mV), 0...250 V AC (min. measurement range 100 V)

configurable, ± 5 A DC (min. measurement range 0.5 A)

1.2...500 kΩ

4...20 mA (current loop)

direct or inverted

configurable, Top and bottom limit values, window range, Alarm delay: 0...99 s

≥ 0.1 % of FS

Transistor, open collector

≤ 30 V DC

20 mA

2-way isolator, between input/output

< 0.1 % of measuring range

With FDT/DTM software

450 ms

Output loop powered

300 V<sub>eff</sub>

DIN EN 61326-1, DIN EN 61010-1

3.51 kV between input and output

4 kV (1.2/50 μs)

2

III

#### Screw connection

#### PUSH IN

2.5 / 0.5 / 2.5

113.6 / 12.5 / 119.2 mm 113.7 / 12.5 / 127.1 mm

#### Type

#### Qty.

#### Order No.

ACT20P-UI-A0-DO-LP-S 1 1453210000

ACT20P-UI-A0-DO-LP-P 1 2456850000

CBX200 USB configuration adapter - 8978580000

**Signal converters**

- Isolation and conversion of DC signals
- 24 V - sensor supply
- Configuration via DIP switch/button
- Supply 12-60 V DC
- 3-way isolation

**ACT20P-AI-A0-DC**

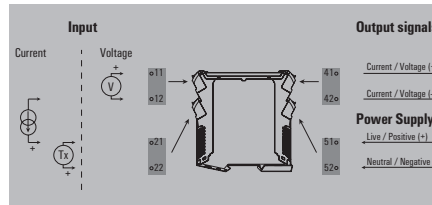

**Technical data**

<b>Input</b>	
Input voltage	configurable, 0-11 V (min. measurement range 2 V)
Input current	configurable, 0-22 mA (min. measurement range 4 mA)
Input resistance, current	100 Ω
Input resistance, voltage	≥ 1 MΩ
Sensor supply	24 V DC
<b>Output</b>	
Output voltage	Adjustable, 0...11 V, Output range, min, 2 V
Output current	Adjustable, 0...22 mA, Output range, min, 4 mA
load impedance voltage	> 600 Ω @ 10 V
Load impedance current	1 kΩ @ 20 mA
Offset voltage	≤ 20 mV
<b>General data</b>	
Galvanic isolation	3-way isolator, between input/output/supply
Linearity	< ± 0.1 % of signal range, Typ. ± 0.05 % of signal range
Temperature coefficient	< 0.05 % / °C
Configuration	DIP switch, Keys and LED display, with reference voltage/current sources
Step response time	350 ms
Voltage supply	12...60 V DC
<b>Insulation coordination</b>	
Standards	IEC 61326-1:2012, UL 61010-1:2012, 3rd Edition
EMC standards	IEC 61326-1
Insulation voltage	2 kV inputs / outputs
Impulse withstand voltage	4 kV (1.2/50 μs)
Overvoltage category	III

<b>Dimensions</b>	
Clamping range (nominal / min. / max.)	mm <sup>2</sup>
Depth / Height / Width	
<b>Note</b>	
<b>Ordering data</b>	
<b>Connection type</b>	
	Screw connection
	PUSH IN connection
<b>Note</b>	
<b>Accessories</b>	
<b>Note</b>	

<b>Dimensions</b>	
Clamping range (nominal / min. / max.)	mm <sup>2</sup>
Depth / Height / Width	
<b>Note</b>	

<b>Screw connection</b>	<b>PUSH IN</b>
1.5 / 0.5 / 2.5	
113.7 / 119.2 / 12.5 mm	113.7 / 127.1 / 12.5 mm

<b>Ordering data</b>	
<b>Connection type</b>	
	Screw connection
	PUSH IN connection
<b>Note</b>	

<b>Type</b>	<b>Qty.</b>	<b>Order No.</b>
ACT20P-AI-A0-DC-S	1	1477420000
ACT20P-AI-A0-DC-P	1	2456860000

<b>Note</b>	
-------------	--

<b>Accessories</b>	
<b>Note</b>	







# Space-saving signal converters – ACT20M

<b>Space-saving signal converters – ACT20M</b>	Introduction	E.2
	Selection table	E.4
	Signal converter	E.6
	Passive isolator	E.10
	Signal splitter	E.12
	Temperature transducers	E.15
	Universal measurement transducers	E.21

# Reliable conversion and isolation of signals in confined spaces

## With ACT20M signal converters with 6 mm wide design

### The new dimension for converting and isolating – housed in a 6 mm width

The ACT20M series of products combines innovative technology with maximum functionality in an electronics housing measuring just 6 mm in width. The ACT20-FEED-IN-PRO-S power-feed unit eliminates the need to wire the power supply to the modules. This reduces the installation time by at least 30%. The ACT20-FEED-IN-PRO-S can supply and monitor up to 120 devices, which are mounted on the CH20 terminal rail bus.

The product line consists of Input Loop Powered, Output Loop Powered and Auxiliary Powered analog isolators and converters, including a universal input converter.

The eight-connection housing allows additional functionality such as 2 channel ILP, 2 channel OLP isolation and signal splitting with input powering option. The configuration is carried out via DIP switches or the FDT/ DTM software. The ACT20M modules are supplied via direct wiring or a rail bus.

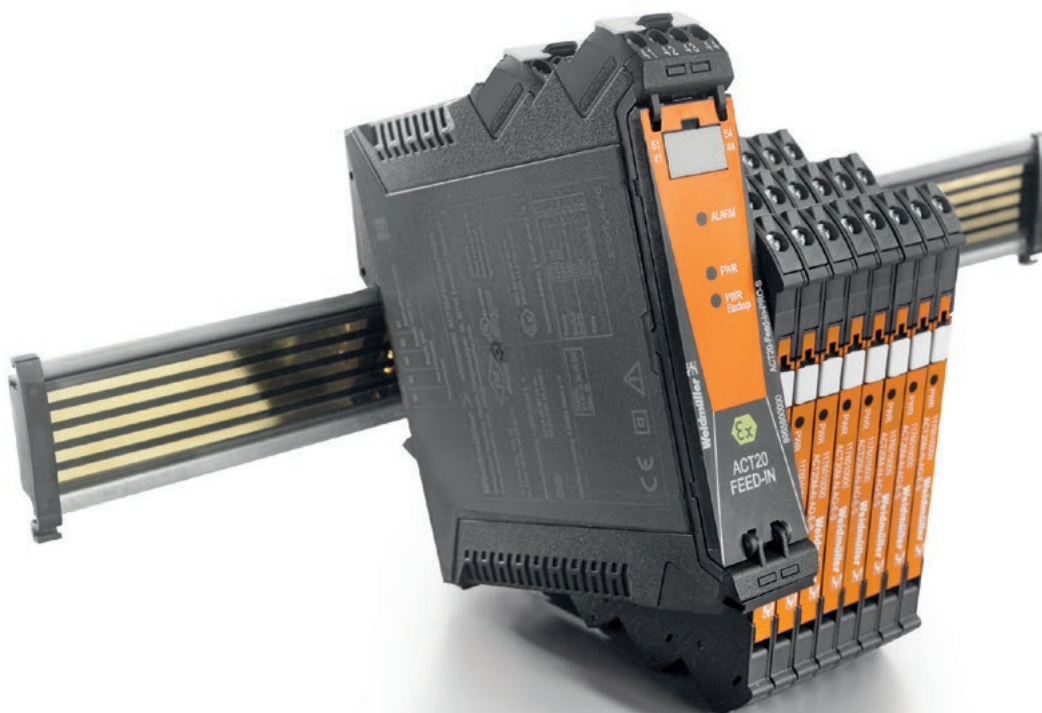

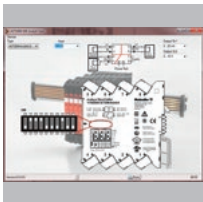
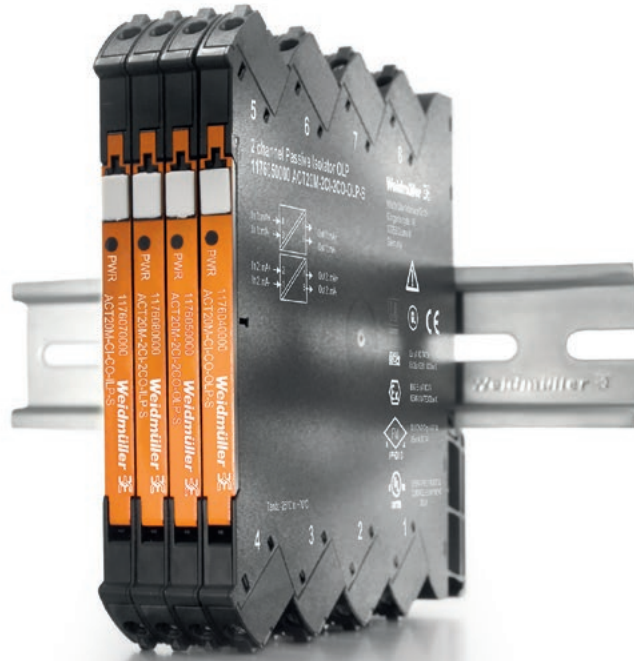

**The DIP switch can be configured simply on the module**

In the "ACT20M Tool" software, simply select the type of input and output, and set the DIP switch configuration as displayed.

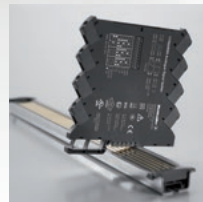

**Installation is simple and quick**

The power supply is simply snapped onto the rail bus for fast and easy installation. The supply can be through any ACT20M module or a separate power-feed unit.



**Easy configuration**

DIP switches on the side are used to configure the input and output parameters, as well as the response time.



**Approvals**

Fulfils the strict standards and requirements of the process industry. Can be used worldwide due to international and local approvals ATEX, IECEx, CULUS, FM, GL and DNV.

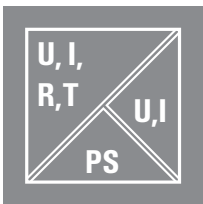

**High level of galvanic isolation**

2.5 kV of electrical isolation (300 V rated voltage) ensures excellent process reliability.

# Selection table



## Selection table

Order No.	Product	Input										Miscellaneous	Sensor feed	Width
		Amount	0...20 mA	4...20 mA	0...10 V	0...5 V	TC	RTD	Frequency					
<b>Space-saving signal converters - ACT20M</b>														
<b>Signal converters</b>														
1175980000	ACT20M-CI-CO-S	1	X	X								4-wire sensor		6.1 mm
1176000000	ACT20M-AI-AO-S	1	X	X	X	X						2-,4-wire sensor	X	6.1 mm
1176010000	ACT20M-AI-AO-E-S	1	X	X	X	X						4-wire sensor		6.1 mm
1375450000	ACT20M-BAI-AO-S	1										-10(20)...+10(20) mA, -5(10)...+5(10) V		6.1 mm
<b>Passive isolators</b>														
1176070000	ACT20M-CI-CO-ILP-S	1	X	X								4-wire sensor		6.1 mm
1176080000	ACT20M-2CI-2CO-ILP-S	2	X	X								4-wire sensor		6.1 mm
1176040000	ACT20M-CI-CO-DLP-S	1		X								2-wire transmitter	X	6.1 mm
1176050000	ACT20M-2CI-2CO-DLP-S	2		X								2-wire transmitter	X	6.1 mm
<b>Signal splitters</b>														
1175990000	ACT20M-CI-2CO-S	1	X	X								4-wire sensor		6.1 mm
1176020000	ACT20M-AI-2SAO-S	1	X	X	X	X						2-,4-wire sensor	X	6.1 mm
1375470000	ACT20M-BAI-2AO-S	1										-10(20)...+10(20) mA, -5(10)...+5(10) V		6.1 mm
<b>Temperature transducer</b>														
1435590000	ACT20M-RTCI-CO-DLP-S	1					X	X				PT100 Type: J,K		6.1 mm
1435610000	ACT20M-RTI-CO-EOLP-S	1						X				PT100		6.1 mm
1375510000	ACT20M-RTI-AO-S	1						X				PT100		6.1 mm
1375520000	ACT20M-RTI-AO-E-S	1						X				PT100		6.1 mm
1375480000	ACT20M-TCI-AO-S	1					X					Type J,K		6.1 mm
1375500000	ACT20M-TCI-AO-E-S	1					X					Type J,K		6.1 mm
<b>Universal measurement transducers</b>														
1176030000	ACT20M-UI-AO-S	1	X	X	X	X	X	X				PT50/100/250/300/400/1000, Ni50/100/1000 Type: B / C / E / J / K / L / N / R / S / T	X	6.1 mm

	Output					Configuration	Auxiliary power	Rated voltage	Isolation	Connection system	Special characteristics
	Amount	0...20 mA	4...20 mA	0...10 V	Relay						
	1	X	X				24 V DC	300 V	3-way	S	ATEX approval Zone 2
	1	X	X	X		DIP switch	24 V DC	300 V	3-way	S	ATEX approval Zone 2
	1	X	X	X		DIP switch	24 V DC	300 V	3-way	S	ATEX approval Zone 2
	1	X	X	X		DIP switch	24 V DC	300 V	2-way	S	ATEX approval Zone 2
	1	X	X				input loop	300 V	2-way	S	ATEX approval Zone 2, Passive converter
	2	X	X				input loop	300 V	2-way	S	ATEX approval Zone 2, Passive converter
	1		X				output loop	300 V	2-way	S	ATEX approval Zone 2, Passive converter
	2		X				output loop	300 V	2-way	S	ATEX approval Zone 2, Passive converter
	2	X	X			DIP switch	24 V DC	300 V	3-way	S	ATEX approval Zone 2
	2	X	X	X		DIP switch	24 V DC	300 V	3-way	S	ATEX approval Zone 2
	2	X	X	X	-10(20)...+10(20) mA	DIP switch	24 V DC	300 V	2-way	S	ATEX approval Zone 2
	1		X		20...4 mA	DIP switch	output loop	300 V	2-way	S	ATEX approval Zone 2, Passive converter
	1		X		20...4 mA	DIP switch	output loop	-	S	ATEX approval Zone 2, Passive converter	
	1	X	X	X	0(1)...5 V	DIP switch	24 V DC	300 V	2-way	S	ATEX approval Zone 2
	1	X	X		0(1)...5 V	DIP switch	24 V DC	-	S	ATEX approval Zone 2	
	1	X	X	X	interne CJC, externe CJC	DIP switch	24 V DC	300 V	2-way	S	ATEX approval Zone 2
	1	X	X	X	interne CJC, externe CJC	DIP switch	24 V DC	-	S	ATEX approval Zone 2	
	1	X	X	X		Software	24 V DC	300 V	3-way	S	ATEX approval Zone 2

Connection system: S = screw / Z = tension clamp / P = Push In, ILP = Input Loop Powered, OLP = Output Loop Powered

Signal converter

Signal converter

- Isolation of DC signals
- Power supply via the mounting rail bus
- 3-way isolation

ACT20M-CI-CO-S

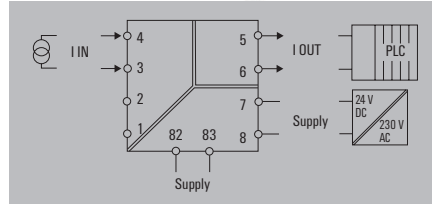
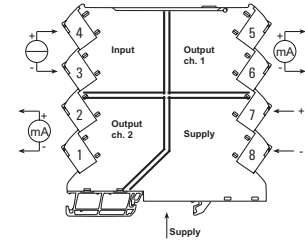

Technical data

Input	
Number of inputs	1
Input current	0...20 mA, 4...20mA
Voltage drop, current input	< 1.5 V
Output	
Number of outputs	1
Output current	0...20 mA, 4...20 mA
Load impedance current	≤ 600 Ω, @ max 23mA
General data	
Configuration	none
Voltage supply	24 V DC ± 30 %
Ambient temperature	-25 °C...70 °C
Accuracy	< 0.05 % of measuring range
Temperature coefficient	≤ 0.01 % / °C
Cut-off frequency (-3 dB)	100 Hz
Power consumption, typ.	0 W
Power consumption, max.	0.7
Step response time	≤ 7 ms
Insulation coordination	
Insulation voltage	2.5 kV <sub>eff</sub> / 1 min.
Rated voltage	300 V <sub>eff</sub>
EMC standards	IEC 61326-1, NE 21
Pollution degree	2
Overvoltage category	II
Approvals	CE; cULus; DETNORVER; DNVGL; EAC; FMEX; IECEXKEM; KEMAATEX

Electrical connections

Terminal	ACT20M-CI-CO-S		
	Input mA	Power Supply	Output 1 mA
1			
2			
3	□		
4	■		
5			■
6			□
7		■	
8		□	

■ = +  
□ = -

Dimensions	
Clamping range (nominal / min. / max.)	mm <sup>2</sup>
Depth x width x height	mm
Note	

Screw connection	
2.5 / 0.5 / 2.5	
114.3 / 6.1 / 112.5	
Power supply optionally over the DIN mounting rail CH20M	

Ordering data

Screw connection
------------------

Type	Qty.	Order No.
ACT20M-CI-CO-S	1	1175980000

Note
------

Accessories

Note
------

DIN mounting rail, see Accessories
------------------------------------

### Signal converter

- Isolation and conversion of DC signals
- Configuration via DIP switches
- Power supply via the mounting rail bus
- 3-way isolation
- Support for adjustment by ACT20M Tool software, download link at [www.weidmueller.com](http://www.weidmueller.com)

### ACT20M-AI-A0-S

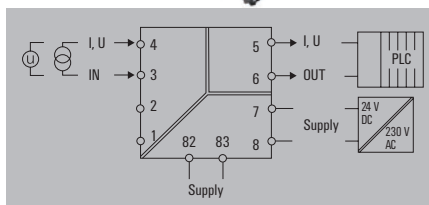
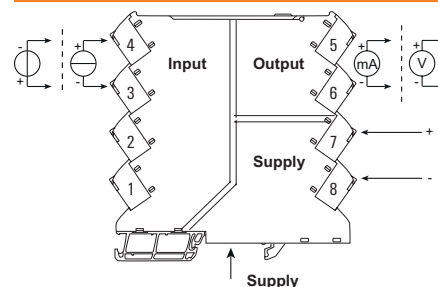

### Technical data

Input	
Input current	
Input voltage	
Sensor supply	
Input resistance, voltage	
Voltage drop, current input	
Output	
Output current	
Output voltage	
Load impedance current	
load impedance voltage	
General data	
Configuration	
Voltage supply	
Ambient temperature	
Accuracy	
Temperature coefficient	
Cut-off frequency (-3 dB)	
Power consumption, typ.	
Power consumption, max.	
Step response time	
Insulation coordination	
Insulation voltage	
Rated voltage	
EMC standards	
Pollution degree	
Overvoltage category	
Approvals	

configurable, 0...20 mA, 4...20mA
configurable, 0(2)...10 V, 0(1)...5 V
17...28 V DC (@ 20 mA)
>500 kΩ
<1,5 V
configurable, 0...20 mA, 4...20 mA
configurable, 0(2)...10 V, 0(1)...5 V
≤ 600 Ω, @ max 23mA
≥ 10 kΩ
DIP switch
24 V DC ± 30 %
-25 °C...70 °C
< 0.05 % of measuring range
≤ 0.01 % / °C
100 Hz
1 W
1.2 W
≤ 7 ms
2.5 kV <sub>eff</sub> / 1 min.
300 V <sub>eff</sub>
IEC 61326-1, NE 21
2
II
CE; cULus; DETNORVER; DNVGL; EAC; FMEX; IECEXKEM; KEMAATEX

### Electrical connections

Terminal	ACT20M-AI-A0-S					
	Input			Power supply	Output 1	
	V	mA	mA Loop		V	mA
1						
2						
3	■	□	■			
4	□	■	□			
5					■	■
6					□	□
7				■		
8				□		

■ = +  
□ = -

### DIP switch settings

Range	Input				Output					
	1	2	3	4	5	6	7	8	9	10
0 ... 20 mA	□	□	□	□	□	□	□	□	□	□
4 ... 20 mA	□	■	□	□	□	■	□	□	□	□
0 ... 10 V	■	□	□	□	■	□	□	□	□	□
2 ... 10 V	■	■	□	□	■	■	□	□	□	□
0 ... 5 V	■	□	■	■	□	□	■	■	■	■
1 ... 5 V	■	■	■	■	■	■	■	■	■	■
0 ... 20 mA loop	■	□	□	□						
4 ... 20 mA loop	■	□	■	□						

■ = on  
□ = off

### Dimensions

Clamping range (nominal / min. / max.)	mm <sup>2</sup>
Depth x width x height	mm
Note	

### Screw connection

2.5 / 0.5 / 2.5
114.3 / 6.1 / 112.5
Power supply optionally over the DIN mounting rail CH20M

### Ordering data

Screw connection
------------------

Type	Qty.	Order No.
ACT20M-AI-A0-S	1	1176000000

### Note

### Accessories

Note
------

DIN mounting rail, see Accessories
------------------------------------

Signal converter

Signal converter

- Isolation and conversion of DC signals
- Configuration via DIP switches
- Power supply via the mounting rail bus
- 3-way isolation
- Support for adjustment by ACT20M Tool software, download link at [www.weidmueller.com](http://www.weidmueller.com)

ACT20M-AI-AO-E-S

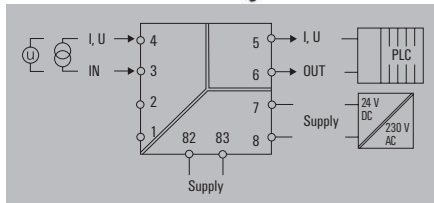
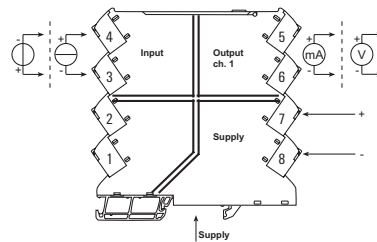

Technical data

Input	
Input current	configurable, 0...20 mA, 4...20mA
Input voltage	configurable, 0(2)...10 V, 0(1)...5 V
Input resistance, voltage	>500 kΩ
Voltage drop, current input	<1,5 V
Output	
Output current	configurable, 0...20 mA, 4...20 mA
Output voltage	configurable, 0(2)...10 V, 0(1)...5 V
Load impedance current	≤ 600 Ω, @ max 23mA
load impedance voltage	≥ 10 kΩ
General data	
Configuration	DIP switch
Voltage supply	24 V DC ± 30 %
Ambient temperature	0 °C...70 °C
Accuracy	< 0.2 % of measuring range
Temperature coefficient	≤ 0.015 % / °C
Cut-off frequency (-3 dB)	100 Hz
Power consumption, typ.	1 W
Power consumption, max.	0.8 W
Step response time	≤ 7 ms
Insulation coordination	
Insulation voltage	2.5 kV <sub>eff</sub> / 1 min.
Rated voltage	300 V <sub>eff</sub>
EMC standards	IEC 61326-1, NE 21
Pollution degree	2
Overvoltage category	II
Approvals	CE; cULus; DETNORVER; DNVGL; EAC

Dimensions	
Clamping range (nominal / min. / max.)	mm <sup>2</sup>
Depth x width x height	mm
Note	

Ordering data

Screw connection
------------------

Note

Accessories

Note
------

Electrical connections										
Terminal	ACT20M-AI-AO-E-S									
	Input		Power supply	Output 1						
	V	mA		V	mA					
1										
2										
3	■	□								
4	□	■								
5				■	■					
6				□	□					
7			■							
8			□							
	■ = + □ = -									
DIP switch settings										
Range	Input				Output					
	1	2	3	4	5	6	7	8	9	10
0 ... 20 mA	□	□	□	□	□	□	□	□	□	□
4 ... 20 mA	□	■	□	□	■	□	□	□	□	□
0 ... 10 V	■	□	□	□	■	□	□	□	□	□
2 ... 10 V	■	■	□	□	■	■	□	□	□	□
0 ... 5 V	■	□	■	■	■	□	■	■	■	■
1 ... 5 V	■	■	■	■	■	■	■	■	■	■
	■ = on □ = off									

Screw connection		
	2.5 / 0.5 / 2.5	
	114.3 / 6.1 / 112.5	
	Power supply optionally over the DIN mounting rail CH20M	

Type	Qty.	Order No.
ACT20M-AI-AO-E-S	1	1176010000

Note
------

Note
------



## Signal converter

- Isolation and conversion of bipolar DC signals into standard signals
- Configuration via DIP switches
- Power supply via the mounting rail bus
- 3-way isolation
- Support for adjustment by ACT20M Tool software, download link at [www.weidmueller.com](http://www.weidmueller.com)

## ACT20M-BAI-A0-S

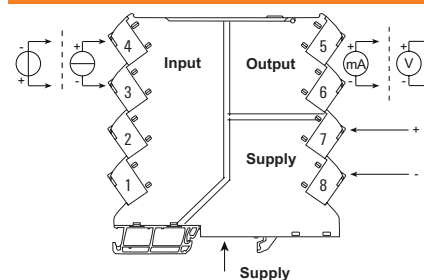
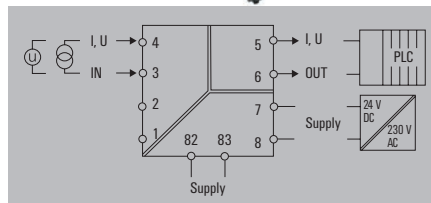

## Technical data

Input	
Input current	configurable, -10 mA...0...+10 mA, -20 mA...0...+20 mA
Input voltage	configurable, -5 V...0...+5 V, -10 V...0...+10 V
Output	
Output current	configurable, 0...20 mA, 4...20 mA
Output voltage	configurable, 0(2)...10 V, 0(1)...5 V
Load impedance current	≤ 600 Ω
load impedance voltage	≥ 10 kΩ
General data	
Configuration	DIP switch
Voltage supply	24 V DC ± 30 %
Ambient temperature	-25 °C...70 °C
Storage temperature	-40 °C...85 °C
Accuracy	< 0.05 % of measuring range
Temperature coefficient	< 0.01 % of span/°C (TU)
Cut-off frequency (-3 dB)	≥ 100 Hz, 10 Hz
Insulation coordination	
Insulation voltage	2.5 kV <sub>eff</sub> / 1 min.
Rated voltage	300 V <sub>eff</sub>
EMC standards	IEC 61326-1, NE 21
Pollution degree	2
Overvoltage category	II
Approvals	
Approvals	cULus; DETNORVER; DNVL; EAC; FMEX; IECEXKEM; KEMAATEX

Dimensions	
Clamping range (nominal / min. / max.)	mm <sup>2</sup>
Depth x width x height	mm
Note	

## Ordering data

Type	Qty.	Order No.
ACT20M-BAI-A0-S	1	1375450000

Note

## Accessories

Note
Mounting rail bus, see accessories

## Electrical connections

Terminal	ACT20M-BAI-A0-S				
	Input		Power supply	Output 1	
	V	mA		V	mA
1					
2					
3	■	□			
4	□	■			
5				■	■
6				□	□
7			■		
8			□		

■ = +  
□ = -

## DIP switch settings

Range	Bandwidth	Input				Output								
		1	2	3	4	5	6	7	8	9	10			
10 Hz	■													
100 Hz	□													
-10...+10 mA		■	■	■										
-20...+20 mA		■	■	□										
-5...+5 V		□	□	■										
-10...+10 V		□	□	□										
0...20 mA					□	□	□							
4...20 mA					□	■	□							
0...10 V					■	□	□							
2...10 V					■	■	□							
0...5 V					■	□	■							
1...5 V					■	■	■							
±20 mA set-up														
±10 mA set-up														

■ = on  
□ = off

## Passive isolator

### Passive isolator

- Isolation of DC signals without additional voltage supply
- Supply from the input measuring circuit
- Optionally available as a 1-channel / 2-channel version
- 2-way isolation

### ACT20M-CI-CO-ILP-S

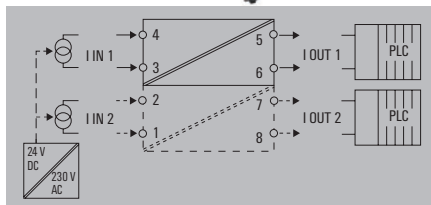
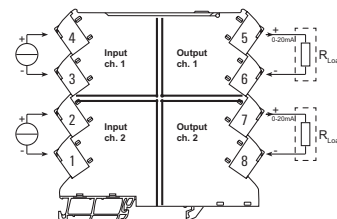

### Technical data

<b>Input</b>	
Voltage drop, current input	1.25 V + 0.015 V <sub>out</sub> @25°C
Input current	0...20 mA, 4...20mA
<b>Output</b>	
Output current	0...20 mA, 4...20 mA
Load impedance current	≤600 Ω
<b>General data</b>	
Configuration	none
Ambient temperature	-25 °C...70 °C
Accuracy	< 0.1 % of measuring range
Temperature coefficient	≤ 0.01 % / °C
Cut-off frequency (-3 dB)	100 Hz
Power consumption	30 mW per channel
Voltage supply	Loop powered, via 4...20 mA input
Step response time	≤ 5 ms
<b>Insulation coordination</b>	
Insulation voltage	2.5 kV <sub>eff</sub> / 1 min.
Rated voltage	300 V <sub>eff</sub>
EMC standards	IEC 61326-1, NE 21
Pollution degree	2
Overvoltage category	II
Approvals	cULus; DETNORVER; DNVGL; EAC; FMEX; IECEXKEM; KEMAATEX

<b>Dimensions</b>	
Clamping range (nominal / min. / max.)	mm <sup>2</sup>
Depth x width x height	mm
<b>Note</b>	

### Ordering data

	1-channel version
	2-channel version

**Note**

### Accessories

**Note**

<b>Screw connection</b>	
	2.5 / 0.5 / 2.5
	114.3 / 6.1 / 112.5
	Power supply optionally over the DIN mounting rail CH20M

<b>Type</b>	<b>Qty.</b>	<b>Order No.</b>
ACT20M-CI-CO-ILP-S	1	1176070000
ACT20M-2CI-2CO-ILP-S	1	1176080000

**Note**

DIN mounting rail, see Accessories

### Electrical connections

Terminal	ACT20M-CI-2CO-S			
	Input 1	Output 1	Input 2	Output 2
	mA	mA	mA	mA
1			□	
2			■	
3	□			
4	■			
5		■		
6		□		
7				■
8				□

### Electrical connections

Terminal	ACT20M-CI-CO-ILP-S	
	Input 1	Output 1
	mA	mA
1		
2		
3	□	
4	■	
5		■
6		□
7		
8		

■ = +  
□ = -

**Passive isolator**

- Isolation of DC signals without additional voltage supply
- Supply from the output measurement circuit
- Optionally available as a 1-channel / 2-channel version
- 2-way isolation

**ACT20M-CI-CO-OLP-S**

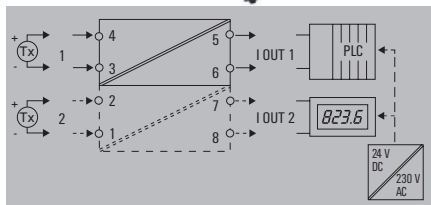
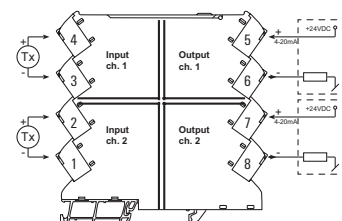

**Technical data**

Input	
Voltage drop, current input	
Input current	
Output	
Output current	
General data	
Configuration	
Ambient temperature	
Accuracy	
Temperature coefficient	
Cut-off frequency (-3 dB)	
Power consumption, max.	
Voltage supply	
Step response time	
Insulation coordination	
Insulation voltage	
Rated voltage	
EMC standards	
Pollution degree	
Overvoltage category	
Approvals	

Typical 2.5 V
4...20mA
4...20 mA
none
-25 °C...70 °C
< 0.05 % of measuring range
≤±0.02 µA x (Δ °C x V <sub>supply</sub> ) @ Tamb > 25 °C
100 Hz
0.5 W
Output loop powered
≤ 5 ms
2.5 kV <sub>eff</sub> /1 min.
300 V <sub>eff</sub>
IEC 61326-1, NE 21
2
II
cULus; DETNORVER; DNVGL; EAC; FMEX; IECEXKEM; KEMAATEX

Dimensions	
Clamping range (nominal / min. / max.)	mm <sup>2</sup>
Depth x width x height	mm
Note	

Screw connection	
2.5 / 0.5 / 2.5	
114.3 / 6.1 / 112.5	
Note	
Power supply optionally over the DIN mounting rail CH20M	

**Ordering data**

1-channel version	
2-channel version	

Type	Qty.	Order No.
ACT20M-CI-CO-OLP-S	1	1176040000
ACT20M-2CI-2CO-OLP-S	1	1176050000

Note
------

**Accessories**

Note
DIN mounting rail, see Accessories

**Electrical connections**

Terminal	ACT20M-2CI-2CO-OLP-S			
	Input 1	Output 1	Input 2	Output 2
	mA	mA	mA	mA
1			□	
2			■	
3	□			
4	■			
5		■		
6		□		
7				■
8				□

**Electrical connections**

Terminal	ACT20M-CI-CO-OLP-S	
	Input 1	Output 1
	mA	mA
1		
2		
3	□	
4	■	
5		■
6		□
7		
8		

■ = +  
□ = -

Signal splitter

Signal splitter

- Isolation and doubling of DC signals
- Power supply via the mounting rail bus
- 4-way isolation

ACT20M-CI-2CO-S

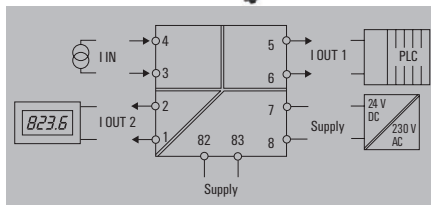
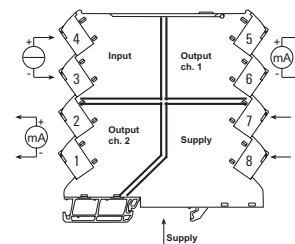

Technical data

Input	
Number of inputs	1
Input current	0...20 mA, 4...20 mA
Voltage drop, current input	< 1.5 V
Output	
Number of outputs	2
Output current	0...20 mA, 4...20 mA
Load impedance current	< 300 Ω, per channel, @ max 23 mA
General data	
Configuration	none
Voltage supply	24 V DC ± 30 %
Ambient temperature	-25 °C...70 °C
Accuracy	< 0.05 % of measuring range
Temperature coefficient	≤ 0.01 % / °C
Cut-off frequency (-3 dB)	100 Hz
Power consumption, typ.	1 W
Power consumption, max.	0.8 W
Step response time	≤ 7 ms
Insulation coordination	
Insulation voltage	2.5 kV <sub>eff</sub> / 1 min.
Rated voltage	300 V <sub>eff</sub>
EMC standards	IEC 61326-1, NE 21
Pollution degree	2
Overvoltage category	II
Approvals	CE; cULus; DETNORVER; DNVGL; EAC; FMEX; IECEXKEM; KEMAATEX

Electrical connections

Terminal	ACT20M-CI-2CO-S			
	Input mA	Power Supply	Output 1 mA	Output 2 mA
1				□
2				■
3	□			
4	■			
5			■	
6			□	
7		■		
8		□		

■ = +  
□ = -

Dimensions	
Clamping range (nominal / min. / max.)	mm <sup>2</sup>
Depth x width x height	mm
Note	

Screw connection	
2.5 / 0.5 / 2.5	
114.3 / 6.1 / 112.5	
Note	
Power supply optionally over the DIN mounting rail CH20M	

Ordering data

Screw connection
------------------

Type	Qty.	Order No.
ACT20M-CI-2CO-S	1	1175990000

Note
------

Accessories

Note
------

DIN mounting rail, see Accessories
------------------------------------

Signal splitter

- Isolation, conversion and doubling of DC signals
- Configuration via DIP switches
- Power supply via the mounting rail bus
- 4-way isolation
- Support for adjustment by ACT20M Tool software, download link at [www.weidmuller.com](http://www.weidmuller.com)

ACT20M-AI-2AO-S

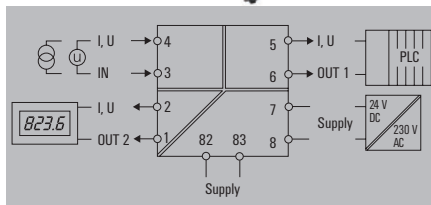
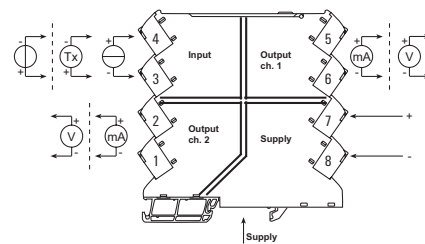

Technical data

Input	
Number of inputs	1
Input current	configurable, 0...20 mA, 4...20mA
Input voltage	configurable, 0(2)...10 V, 0(1)...5 V
Sensor supply	17...28 V DC (@ 20 mA)
Input resistance, voltage	500 kΩ
Voltage drop, current input	< 1.5 V
Output	
Number of outputs	2
Output current	Adjustable, 0...20 mA, 4...20 mA
Output voltage	configurable, 0(2)...10 V, 0(1)...5 V
Load impedance current	< 300 Ω, per channel, @ max 23mA
load impedance voltage	≥ 10 kΩ
General data	
Configuration	DIP switch
Voltage supply	24 V DC ± 30 %
Ambient temperature	-25 °C...70 °C
Accuracy	< 0.05 % of measuring range
Temperature coefficient	≤ 0.01 % / °C
Cut-off frequency (-3 dB)	100 Hz
Power consumption, typ.	1 W
Power consumption, max.	1.2 W
Step response time	≤ 7 ms
Insulation coordination	
Insulation voltage	2.5 kV <sub>eff</sub> / 1 min.
Rated voltage	300 V <sub>eff</sub>
EMC standards	IEC 61326-1, NE 21
Pollution degree	2
Overvoltage category	II
Approvals	CE; cULus; DETNORVER; DNVGL; EAC; FMEX; IECEXKEM; KEMAATEX

Dimensions	
Clamping range (nominal / min. / max.)	mm <sup>2</sup>
Depth x width x height	mm
Note	

Ordering data

Screw connection
------------------

Note

Accessories

Note	
------	--

Screw connection	
2.5 / 0.5 / 2.5	
114.3 / 6.1 / 112.5	
Power supply optionally over the DIN mounting rail CH20M	

Type	Qty.	Order No.
ACT20M-AI-2AO-S	1	1176020000

Note	
DIN mounting rail, see Accessories	

Electrical connections

Terminal	ACT20M-AI-2AO-S							
	Input			Power supply	Output 1		Output 2	
	V	mA	mA Loop		V	mA	V	mA
1								
2							■	■
3	■	□	■					
4	□	■	□					
5					■	■		
6					□	□		
7				■				
8				□				

■ = +  
□ = -

DIP switch settings

Range	Input				Output 1		Output 2	
	1	2	3	4	5	6	7	8
0 ... 20 mA	□	□	□	□	□	□	□	□
4 ... 20 mA	□	■	□	□	■	□	□	■
0 ... 10 V	■	□	□	□	□	□	□	□
2 ... 10 V	■	□	□	□	■	□	■	□
0 ... 5 V	■	□	■	■	□	■	■	■
1 ... 5 V	■	□	■	■	■	■	■	■
0 ... 20 mA loop	■	□	□	□				
4 ... 20 mA loop	■	□	■	□				

■ = on  
□ = off

Signal splitter

Signal splitter

- Isolation and conversion of bipolar DC signals
- Splitting into standard signal or bipolar output
- Configuration via DIP switches
- Power supply via the mounting rail bus
- 4-way isolation
- Support for adjustment by ACT20M Tool software, download link at [www.weidmueller.com](http://www.weidmueller.com)

ACT20M-BAI-2A0-S

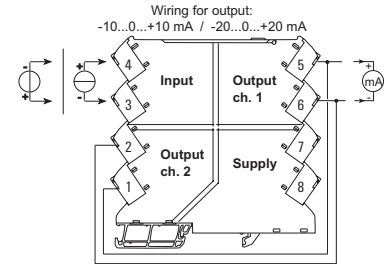
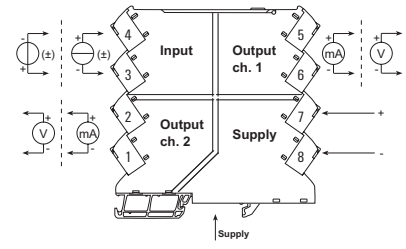
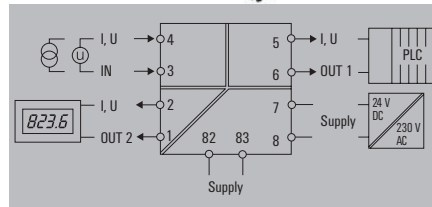

Technical data

<b>Input</b>	
Number of inputs	1
Input current	configurable, -10 mA...0...+10 mA, -20 mA...0...+20 mA
Input voltage	configurable, -5 V...0...+5 V, -10 V...0...+10 V
<b>Output</b>	
Number of outputs	2
Output current	configurable, 0...20 mA, 4...20 mA, 1 channel -10...0...+10 mA, 1 channel -20...0...+20 mA
Output voltage	configurable, 0(2)...10 V, 0(1)...5 V
Load impedance current	< 300 Ω, per channel
load impedance voltage	≥ 10 kΩ
<b>General data</b>	
Voltage supply	24 V DC ± 30 %
Ambient temperature	-25 °C...70 °C
Storage temperature	-40 °C...85 °C
Accuracy	< 0.05 % of measuring range
Temperature coefficient	< 0.01% of span/°C (TU)
Cut-off frequency (-3 dB)	≥ 100 Hz, 10 Hz
<b>Insulation coordination</b>	
Insulation voltage	2.5 kV <sub>eff</sub> / 1 min.
Rated voltage	300 V <sub>eff</sub>
EMC standards	IEC 61326-1, NE 21
Pollution degree	2
Overvoltage category	II
<b>Approvals</b>	
Approvals	cULus; DETNORVER; DNVL; EAC; FMEX; IECEKEM; KEMAATEX

<b>Dimensions</b>	
Clamping range (nominal / min. / max.)	mm <sup>2</sup>
Depth x width x height	mm
<b>Note</b>	

Ordering data

Type	Qty.	Order No.
ACT20M-BAI-2A0-S	1	1375470000

<b>Note</b>
-------------

Accessories

<b>Note</b>
-------------

<b>Screw connection</b>	
2.5 / 0.5 / 2.5	
114.3 / 6.1 / 112.5	

Electrical connections

Terminal	ACT20M-BAI-2A0-S							
	Input		Power supply	Output 1		Output 2		
	V	mA		V	mA	V	mA	
1						<input type="checkbox"/>	<input type="checkbox"/>	
2						<input checked="" type="checkbox"/>	<input checked="" type="checkbox"/>	
3	<input checked="" type="checkbox"/>	<input type="checkbox"/>						
4	<input type="checkbox"/>	<input checked="" type="checkbox"/>						
5				<input checked="" type="checkbox"/>	<input checked="" type="checkbox"/>			
6				<input type="checkbox"/>	<input type="checkbox"/>			
7			<input checked="" type="checkbox"/>					
8			<input type="checkbox"/>					

= +  
 = -

DIP switch settings

Range	Bandwidth	Input				Output 1				Output 2	
		1	2	3	4	5	6	7	8	9	10
10 Hz		<input checked="" type="checkbox"/>									
100 Hz		<input type="checkbox"/>									
-10...+10 mA		<input checked="" type="checkbox"/>	<input checked="" type="checkbox"/>	<input checked="" type="checkbox"/>							
-20...+20 mA		<input checked="" type="checkbox"/>	<input checked="" type="checkbox"/>	<input type="checkbox"/>							
-5...+5 V		<input type="checkbox"/>	<input type="checkbox"/>	<input checked="" type="checkbox"/>							
-10...+10 V		<input type="checkbox"/>	<input type="checkbox"/>	<input type="checkbox"/>							
0...20 mA			<input type="checkbox"/>	<input type="checkbox"/>	<input type="checkbox"/>	<input type="checkbox"/>	<input type="checkbox"/>	<input type="checkbox"/>	<input type="checkbox"/>	<input type="checkbox"/>	<input type="checkbox"/>
4...20 mA			<input type="checkbox"/>	<input checked="" type="checkbox"/>	<input type="checkbox"/>	<input type="checkbox"/>	<input type="checkbox"/>	<input checked="" type="checkbox"/>	<input type="checkbox"/>	<input type="checkbox"/>	<input type="checkbox"/>
0...10 V			<input checked="" type="checkbox"/>	<input type="checkbox"/>	<input type="checkbox"/>	<input type="checkbox"/>	<input checked="" type="checkbox"/>	<input type="checkbox"/>	<input type="checkbox"/>	<input type="checkbox"/>	<input type="checkbox"/>
2...10 V			<input checked="" type="checkbox"/>	<input type="checkbox"/>	<input type="checkbox"/>	<input type="checkbox"/>	<input checked="" type="checkbox"/>	<input type="checkbox"/>	<input type="checkbox"/>	<input type="checkbox"/>	<input type="checkbox"/>
0...5 V			<input checked="" type="checkbox"/>	<input type="checkbox"/>	<input type="checkbox"/>	<input type="checkbox"/>	<input type="checkbox"/>	<input type="checkbox"/>	<input type="checkbox"/>	<input checked="" type="checkbox"/>	<input checked="" type="checkbox"/>
1...5 V			<input checked="" type="checkbox"/>	<input type="checkbox"/>	<input type="checkbox"/>	<input type="checkbox"/>	<input type="checkbox"/>	<input type="checkbox"/>	<input type="checkbox"/>	<input checked="" type="checkbox"/>	<input checked="" type="checkbox"/>
±20 mA set-up			<input type="checkbox"/>	<input type="checkbox"/>	<input checked="" type="checkbox"/>	<input type="checkbox"/>	<input type="checkbox"/>	<input type="checkbox"/>	<input type="checkbox"/>	<input checked="" type="checkbox"/>	<input checked="" type="checkbox"/>
±10 mA set-up			<input type="checkbox"/>	<input checked="" type="checkbox"/>	<input type="checkbox"/>	<input type="checkbox"/>	<input type="checkbox"/>	<input type="checkbox"/>	<input type="checkbox"/>	<input checked="" type="checkbox"/>	<input checked="" type="checkbox"/>

= on  
 = off

Temperature transducers

- Isolation and conversion of temperature signals, (RTD and thermocouple)
- Configuration via DIP switches
- Power supply via the output circuit
- 2-way isolation

ACT20M-RTCI-CO-OLP-S

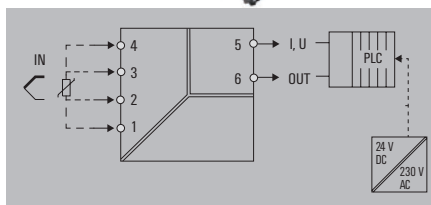
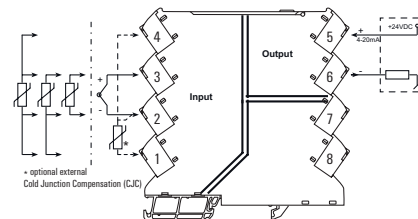

Technical data

<b>Input</b>	
Sensor	
Input measurement range	
Temperature input range	
<b>Output</b>	
Output current	
Sensor error detection	
<b>General data</b>	
Configuration	
Voltage supply	
Power consumption, max.	
Storage temperature	
Accuracy	
Galvanic isolation	
Step response time	
Ambient temperature	
<b>Insulation coordination</b>	
Insulation voltage	
Rated voltage	
EMC standards	
Pollution degree	
Overtolerance category	
<b>Approvals</b>	
Approvals	
<b>Dimensions</b>	
Clamping range (nominal / min. / max.)	mm <sup>2</sup>
Depth x width x height	mm
<b>Note</b>	

<b>Input</b>	
PT100 / 2-/3-/4-wire, Thermocouple acc. to IEC 584, type: J, Thermocouple acc. to IEC 584, type: K	
PT100 -200...+850 °C, Thermocouple type J -100...+1200°C, Thermocouple type K -200...+1370°C	
Configurable, min. measurement range 10°C (RTD), min. measurement range 50°C (TC)	
<b>Output</b>	
configurable, 4...20 mA, 20...4 mA	
3.5 mA / 23 mA / none	
<b>General data</b>	
DIP switch	
Output loop powered, 6...35 V	
0.8 W	
-40 °C...85 °C	
absolute accuracy: < ±0.05 % of the measurement range, RTD (PT100) Basic accuracy: < ±0.1 °C of the measurement range, TC (J,K) Basic accuracy: < ±0.5 °C of the measurement range	
2-way isolator	
≤ 30 ms, < 300 ms	
-25 °C...+70 °C	
<b>Insulation coordination</b>	
2.5 kV <sub>eff</sub> / 1 min.	
300 V <sub>eff</sub>	
IEC 61326-1, NE 21	
2	
<b>Approvals</b>	
cULus; DETNORVER; DNVGL; EAC; FMEx; IECExKEM; KEMAATEX	
<b>Screw connection</b>	
2.5 / 0.5 / 2.5	
114.3 / 6.1 / 112.5	

Ordering data

<b>Type</b>		
ACT20M-RTCI-CO-OLP-S	Qty.	Order No.
	1	1435590000
<b>Note</b>		

<b>Type</b>		
ACT20M-RTCI-CO-OLP-S	Qty.	Order No.
	1	1435590000
<b>Note</b>		
DIN mounting rail, see accessories		

Accessories

<b>Note</b>		
-------------	--	--

Electrical connections

Terminal	ACT20M-RTCI-CO-OLP-S				
	Input				Output 1
	2 wire	3 wire	4 wire	TC	mA
1		Sense-	Sense-	CJC+*	
2	R	R-	R-	TC/CJC*	
3	R	R+	R+	TC+	
4			Sense+	CJC*	
5					■
6					□
7					
8					

\* optional  
 ■ = +  
 □ = -

Configuration

Temp.	Temperature range [°C]									
	Pt100: -200...+850 °C // TC J: -100...+1200 °C					TC K: -180...+1372 °C				
	Min.	S2	Max.	S2	Max.	S2	Min.	S2	Max.	S2
-200		0				170				
-180	■	5				180	■			
-150	■	10			■	190	■			■
-100	■	15			■	200	■			■
-50	■	20			■	225	■			■
-25	■	25			■	250	■			■
-10	■	30			■	275	■			■
-5	■	35			■	300	■			■
0	■	40			■	325	■			■
5	■	45			■	350	■			■
10	■	50			■	375	■			■
20	■	55			■	400	■			■
25	■	60			■	450	■			■
50	■	65			■	500	■			■
100	■	70			■	550	■			■
200	■	75			■	600	■			■
		80			■	650	■			■
		85			■	700	■			■
		90			■	750	■			■
		95			■	800	■			■
		100			■	850	■			■
		105			■	900	■			■
		110			■	950	■			■
		115			■	1000	■			■
		120			■	1050	■			■
		125			■	1100	■			■
		130			■	1150	■			■
		135			■	1200	■			■
		140			■	1250	■			■
		145			■	1300	■			■
		150			■	1350	■			■
		160			■	1372	■			■

■ = On

Temperature transducers

Temperature transducers

- Conversion of temperature signals, RTD
- Configuration via DIP switches
- Power supply via the output circuit

ACT20M-RTI-CO-EOLP-S

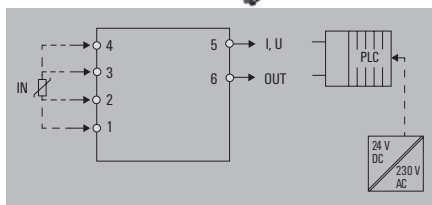
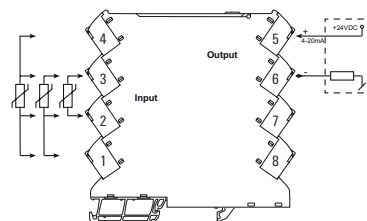

Technical data

Input	
Sensor	PT100 / 2-/3-/4-wire
Input measurement range	PT100 -200...+850 °C
Temperature input range	Configurable, min. measurement range 10°C (RTD)
Output	
Output current	configurable, 4...20 mA, 20...4 mA
Sensor error detection	3.5 mA / 23 mA / none
General data	
Configuration	DIP switch
Voltage supply	Output loop powered, 6...35 V
Power consumption, max.	0.8 W
Storage temperature	-40 °C...85 °C
Accuracy	absolute accuracy: <math>\lt; \pm 0.1\%</math> of the measurement range, Basic accuracy: <math>\lt; \pm 0.2\text{°C}</math>
Galvanic isolation	Without isolation
Step response time	$\leq 30\text{ ms}, < 300\text{ ms}</math>$
Ambient temperature	-25 °C...+70 °C
EMC standards	IEC 61326-1, NE 21
Approvals	
Approvals	cULus; DETNORVER; DNVGL; EAC; FMEX; IECEXKEM; KEMAATEX

Dimensions	
Clamping range (nominal / min. / max.)	mm <sup>2</sup>
Depth x width x height	mm
Note	

Ordering data

Type	Qty.	Order No.
ACT20M-RTI-CO-EOLP-S	1	1435610000
Note		

Accessories

Note
DIN mounting rail, see accessories

Dimensions		Screw connection	
		2.5 / 0.5 / 2.5	
		114.3 / 6.1 / 112.5	

Type	Qty.	Order No.
ACT20M-RTI-CO-EOLP-S	1	1435610000

Note
DIN mounting rail, see accessories

Electrical connections

Terminal	ACT20M-RTCI-CO-OPLS			Output 1 mA
	Input			
	RTD			
	2 wire	3 wire	4 wire	
1		Sense-	Sense-	
2	R	R-	R-	
3	R	R+	R+	
4			Sense+	
5				■
6				□
7				
8				

\* optional

■ = +

□ = -

Configuration

Temp.	Temperature range [°C]									
	Pt100: -200...+850 °C // TC J: -100...+1200 °C					TC K: -180...+1372 °C				
Min.	S2	Max.	S2	Max.	S2	Min.	S2	Max.	S2	Max.
-200		0		170						
-180		5		180						
-150		10		190						
-100		15		200						
-50		20		225						
-25		25		250						
-10		30		275						
-5		35		300						
0		40		325						
5		45		350						
10		50		375						
20		55		400						
25		60		450						
50		65		500						
100		70		550						
200		75		600						
		80		650						
		85		700						
		90		750						
		95		800						
		100		850						
		105								
		110								
		115								
		120								
		125								
		130								
		135								
		140								
		145								
		150								
		160								

■ = On



Temperature transducers

- Isolation and conversion of temperature signals, RTD (PT100)
- Configuration via DIP switches
- Power supply via the mounting rail bus
- 3-way isolation

ACT20M-RTI-A0-S

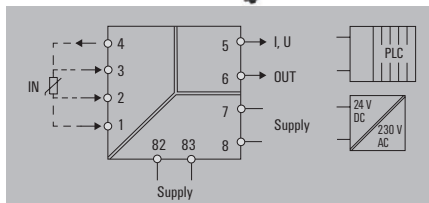
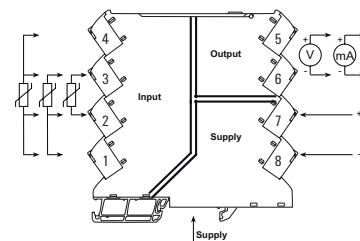

Technical data

Input	
Sensor	PT100 / 2-/3-/4-wire
Input measurement range	PT100 -200...+850 °C
Temperature input range	Configurable, min. measurement range 10°C (RTD)
Output	
Output current	configurable, 0...20 mA, 4...20 mA
Output voltage	configurable, 0(2)...10 V, 0(1)...5 V
Load impedance current	≤ 600 Ω
load impedance voltage	≥ 10 kΩ
Sensor error detection	3.5 mA / 23 mA / none
General data	
Configuration	DIP switch
Voltage supply	24 V DC ± 30 %
Power consumption, max.	0.7 W
Accuracy	absolute accuracy: < ±0.05 % of the measurement range, Basic accuracy: < ±0.1 °C
Galvanic isolation	3-way isolator
Temperature coefficient	≤ 0.01 % of the measurement range/°C or 0.02 °C/°C
Step response time	≤ 30 ms
Ambient temperature	-25 °C...+70 °C
Insulation coordination	
Insulation voltage	2.5 kV <sub>eff</sub> / 1 min.
Rated voltage	300 V <sub>eff</sub>
EMC standards	IEC 61326-1, NE 21
Pollution degree	2
Overtvoltage category	II
Approvals	
Approvals	cULus; DETNORVER; DNVGL; EAC; FMEX; IECEXKEM; KEMAATEX

Dimensions	
Clamping range (nominal / min. / max.)	mm <sup>2</sup>
Depth x width x height	mm
Note	

Ordering data

Type	Qty.	Order No.
ACT20M-RTI-A0-S	1	1375510000
Note		

Accessories

Note
DIN mounting rail, see accessories

Electrical connections

Terminal	ACT20M-RTI-A0-S					
	Input			Power supply	Output 1	
	RTD				V	mA
	2 wire	3 wire	4 wire			
1		Sense-	Sense-			
2	R	R-	R-			
3	R	R+	R+			
4		Sense+				
5					■	■
6					□	□
7				■		
8					□	

■ = +  
□ = -

Configuration

Temperature range [°C]																		
Pt100: -200...+850 °C																		
Min.	S2				Max.	S2				Max.	S2							
Temp.	1	2	3	4	Temp.	5	6	7	8	9	10	Temp.	5	6	7	8	9	10
-200					0							170	■					
-180				■	5					■		180	■					■
-150			■		10					■		190	■					■
-100			■	■	15					■	■	200	■					■
-50		■			20					■		225	■					■
-25		■	■		25					■	■	250	■					■
-10		■	■	■	30					■	■	275	■					■
-5		■	■	■	35					■	■	300	■					■
0	■				40					■	■	325	■					■
5	■	■			45					■	■	350	■					■
10	■	■	■		50					■	■	375	■					■
20	■	■	■	■	55					■	■	400	■					■
25	■	■	■	■	60					■	■	450	■					■
50	■	■	■	■	65					■	■	500	■					■
100	■	■	■	■	70					■	■	550	■					■
200	■	■	■	■	75					■	■	600	■					■
					80					■		650	■					■
					85					■		700	■					■
					90					■		750	■					■
					95					■		800	■					■
					100					■		850	■					■
					105					■	■							
					110					■	■							
					115					■	■							
					120					■								
					125					■								
					130					■	■							
					135					■	■							
					140					■	■							
					145					■	■							
					150					■	■							
					160					■	■							

■ = On

Temperature transducers

Temperature transducers

- Conversion of temperature signals, RTD (PT100)
- Configuration via DIP switches

ACT-20M-RTI-A0-E-S

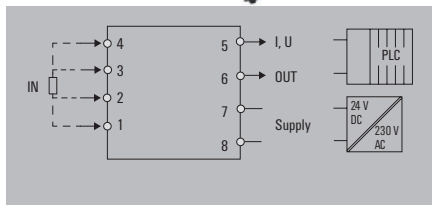
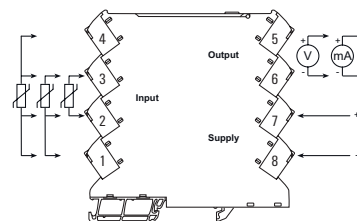

Technical data

Input	
Sensor	PT100 / 2-/3-/4-wire
Input measurement range	PT100 -200...+850 °C
Temperature input range	Configurable, min. measurement range 10°C (RTD)
Output	
Output current	configurable, 0...20 mA, 4...20 mA
Output voltage	configurable, 0(2)...10 V, 0(1)...5 V
Load impedance current	≤ 600 Ω
load impedance voltage	≥ 10 kΩ
Sensor error detection	3.5 mA / 23 mA / none
General data	
Configuration	DIP switch
Voltage supply	24 V DC ± 30 %
Power consumption, max.	0.5 W
Accuracy	absolute accuracy: < ±0.1 % of the measurement range
Galvanic isolation	Without isolation
Temperature coefficient	≤ 0.01 % of the measurement range/°C or 0.02 °C/°C
Step response time	≤ 30 ms
Ambient temperature	-25 °C...+70 °C
EMC standards	IEC 61326-1, NE 21
Approvals	
Approvals	cULus; DETNORVER; DNVGL; EAC; FMEX; IECEXKEM; KEMAATEX

Dimensions	
Clamping range (nominal / min. / max.)	mm <sup>2</sup>
Depth x width x height	mm
Note	

Ordering data

Type	Qty.	Order No.
ACT20M-RTI-A0-E-S	1	1375520000
Note		

Accessories

Note
DIN mounting rail, see accessories

Screw connection	
2.5 / 0.5 / 2.5	
114.3 / 6.1 / 112.5	

Electrical connections

Terminal	ACT20M-RTI-A0-E-S					
	Input			Power supply	Output 1	
	2 wire	3 wire	4 wire		V	mA
1		Sense-	Sense-			
2	R	R-	R-			
3	R	R+	R+			
4		Sense+				
5					■	■
6					□	□
7				■		
8					□	

■ = +  
□ = -

Configuration

Temperature range [°C]																		
Pt100: -200...+850 °C																		
Min.	S2				Max.	S2				Max.	S2							
Temp.	1	2	3	4	Temp.	5	6	7	8	9	10	Temp.	5	6	7	8	9	10
-200				0								170	■					
-180			■	5						■	180	■						■
-150		■		10						■	190	■						■
-100		■	■	15						■	200	■						■
-50		■	■	20					■	■	225	■						■
-25		■	■	25					■	■	250	■						■
-10		■	■	30					■	■	275	■						■
-5		■	■	35					■	■	300	■						■
0	■			40					■	■	325	■						■
5	■			45					■	■	350	■						■
10	■	■		50					■	■	375	■						■
20	■	■	■	55					■	■	400	■						■
25	■	■	■	60					■	■	450	■						■
50	■	■	■	65					■	■	500	■						■
100	■	■	■	70					■	■	550	■						■
200	■	■	■	75					■	■	600	■						■
				80					■	■	650	■						■
				85					■	■	700	■						■
				90					■	■	750	■						■
				95					■	■	800	■						■
				100					■	■	850	■						■
				105					■	■								
				110					■	■								
				115					■	■								
				120					■	■								
				125					■	■								
				130					■	■								
				135					■	■								
				140					■	■								
				145					■	■								
				150					■	■								
				160					■	■								

■ = On

Temperature transducers

- Isolation and conversion of temperature signals, (thermocouple)
- Configuration via DIP switches
- Power supply via the mounting rail bus
- 3-way isolation

ACT20M-TCI-A0-S

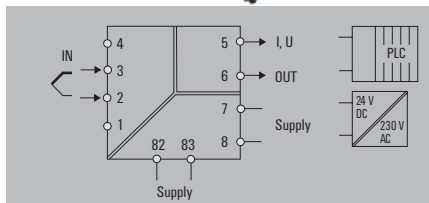
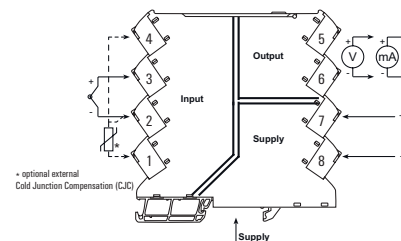

Technical data

<b>Input</b>
Sensor
Input measurement range
Temperature input range
<b>Output</b>
Output current
Output voltage
Load impedance current
load impedance voltage
Sensor error detection
<b>General data</b>
Configuration
Voltage supply
Power consumption, max.
Accuracy
Galvanic isolation
Temperature coefficient
Step response time
Ambient temperature
<b>Insulation coordination</b>
Insulation voltage
Rated voltage
EMC standards
Pollution degree
Overvoltage category
<b>Approvals</b>
Approvals

Thermocouple (type J, K)
Thermocouple type J -100...+1200°C, Thermocouple type K -200...+1370°C
Configurable, min. measurement range 50°C (TC)
configurable, 0...20 mA, 4...20 mA
configurable, 0(2)...10 V, 0(1)...5 V
≤ 600 Ω
≥ 10 kΩ
Configurable, 3.5 mA / 23 mA / none
DIP switch
24 V DC ± 30 %
0.7 W
absolute accuracy: < ±0.05 % of the measurement range, Basic accuracy: < ±0.5°
3-way isolator
0,1 °C / °C, or, ≤ 0,01% des Messbereichs/°C
≤ 30 ms, < 300 ms, Configurable
-25 °C...+70 °C
2.5 kV <sub>eff</sub> / 1 min.
300 V <sub>eff</sub>
IEC 61326-1, NE 21
2
II
cULus; DETNORVER; DNVL; EAC; FMEX; IECEXKEM; KEMAATEX

<b>Dimensions</b>	
Clamping range (nominal / min. / max.)	mm <sup>2</sup>
Depth x width x height	mm
<b>Note</b>	

<b>Screw connection</b>
2.5 / 0.5 / 2.5
114.3 / 6.1 / 112.5

Ordering data

<b>Type</b>	<b>Qty.</b>	<b>Order No.</b>
ACT20M-TCI-A0-S	1	1375480000

<b>Type</b>	<b>Qty.</b>	<b>Order No.</b>
ACT20M-TCI-A0-S	1	1375480000

Accessories

<b>Note</b>
-------------

DIN mounting rail, see accessories
------------------------------------

Electrical connections

Terminal	ACT20M-TCI-A0-S		
	Input TC	Power supply	Output 1
1	CJC+ <sup>1,2)</sup>		V
2	TC-/CJC <sup>1,2)</sup>		mA
3	TC+		
4	CJC <sup>1,2)</sup>		
5		■	■
6		□	□
7		■	
8		□	

1) only 2) optional

■ = +

□ = -

Configuration

Temp.	Temperature range [°C]									
	TC J: -100...+1200 °C					TC K: -180...+1372 °C				
	Min.	S2	Max.	S2	Max.	S2	Max.	S2	Max.	S2
-200			0					170	■	
-180		■	5			■		180	■	■
-150	■		10		■			190	■	■
-100	■	■	15		■	■		200	■	■
-50	■	■	20		■	■		225	■	■
-25	■	■	25		■	■		250	■	■
-10	■	■	30		■	■		275	■	■
-5	■	■	35		■	■		300	■	■
0	■	■	40		■	■		325	■	■
5	■	■	45		■	■		350	■	■
10	■	■	50		■	■		375	■	■
20	■	■	55		■	■		400	■	■
25	■	■	60		■	■		450	■	■
50	■	■	65		■	■		500	■	■
100	■	■	70		■	■		550	■	■
200	■	■	75		■	■		600	■	■
			80	■				650	■	■
			85	■				700	■	■
			90	■				750	■	■
			95	■				800	■	■
			100	■				850	■	■
			105	■				900	■	■
			110	■				950	■	■
			115	■				1000	■	■
			120	■				1050	■	■
			125	■				1100	■	■
			130	■				1150	■	■
			135	■				1200	■	■
			140	■				1250	■	■
			145	■				1300	■	■
			150	■				1350	■	■
			160	■				1372	■	■

■ = On

## Temperature transducers

### Temperature transducers

- Conversion of temperature signals, (thermocouple)
- Configuration via DIP switches

### ACT-20M-TCI-A0-E-S

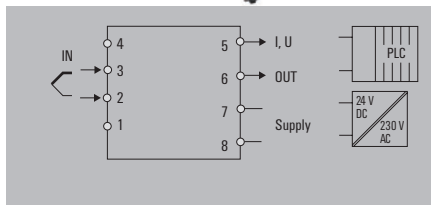
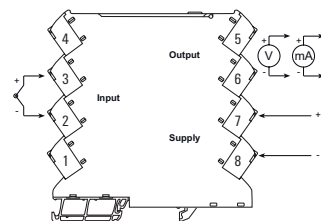

### Technical data

Input	
Sensor	Thermocouple (type J, K)
Input measurement range	Thermocouple type J -100...+1200°C, Thermocouple type K -200...+1370°C
Temperature input range	Configurable, min. measurement range 50°C (TC)
Output	
Output current	configurable, 0...20 mA, 4...20 mA
Output voltage	configurable, 0(2)...10 V, 0(1)...5 V
Load impedance current	≤ 600 Ω
load impedance voltage	≥ 10 kΩ
Sensor error detection	Configurable, 3.5 mA / 23 mA / none
General data	
Configuration	DIP switch
Voltage supply	24 V DC ± 30 %
Power consumption, max.	0.5 W
Accuracy	absolute accuracy: < ±0.1 % of the measurement range, Basic accuracy: < ±1 °C
Galvanic isolation	Without isolation
Temperature coefficient	0,1 °C / °C, or, ≤ 0,01% des Messbereichs/°C
Step response time	≤ 30 ms, < 300 ms, Configurable
Ambient temperature	-25 °C...+70 °C
EMC standards	IEC 61326-1, NE 21
Approvals	
Approvals	cULus; DETNORVER; DNVGL; EAC; FMEX; IECEXKEM; KEMAATEX

Dimensions	
Clamping range (nominal / min. / max.)	mm <sup>2</sup>
Depth x width x height	mm
Note	

### Ordering data

Type	Qty.	Order No.
ACT20M-TCI-A0-E-S	1	1375500000
Note		

### Accessories

Note
DIN mounting rail, see accessories

### Electrical connections

Terminal	ACT20M-TCI-A0-E-S		
	Input TC	Power supply	Output 1 V mA
1	CJC+ <sup>1,2)</sup>		
2	TC-/CJC- <sup>1,2)</sup>		
3	TC+		
4	CJC- <sup>1,2)</sup>		
5		■	■
6		□	□
7		■	
8		□	

1) only 2) optional

■ = +

□ = -

### Configuration

		Temperature range [°C]									
		TC J: -100...+1200 °C					TC K: -180...+1372 °C				
Min.	S2	Max.	S2	Max.	S2	Min.	S2	Max.	S2	Max.	S2
Temp.	1	2	3	4	Temp.	5	6	7	8	9	10
-200				0						170	■
-180			■	5					■	180	■
-150		■		10				■		190	■
-100		■	■	15				■	■	200	■
-50		■	■	20				■	■	225	■
-25		■	■	25				■	■	250	■
-10		■	■	30				■	■	275	■
-5		■	■	35				■	■	300	■
0	■			40				■		325	■
5	■			45				■		350	■
10	■	■		50				■	■	375	■
20	■	■	■	55				■	■	400	■
25	■	■	■	60				■	■	450	■
50	■	■	■	65				■	■	500	■
100	■	■	■	70				■	■	550	■
200	■	■	■	75				■	■	600	■
				80				■		650	■
				85				■	■	700	■
				90				■	■	750	■
				95				■	■	800	■
				100				■	■	850	■
				105				■	■	900	■
				110				■	■	950	■
				115				■	■	1000	■
				120				■	■	1050	■
				125				■	■	1100	■
				130				■	■	1150	■
				135				■	■	1200	■
				140				■	■	1250	■
				145				■	■	1300	■
				150				■	■	1350	■
				160				■	■	1372	■

■ = On

### Universal measurement and signal converter

- Isolation and conversion of temperature signals and DC signals
- Configuration using FDT/DTM software
- Power supply via the mounting rail bus
- 3-way isolation

### ACT20M-UI-A0-S

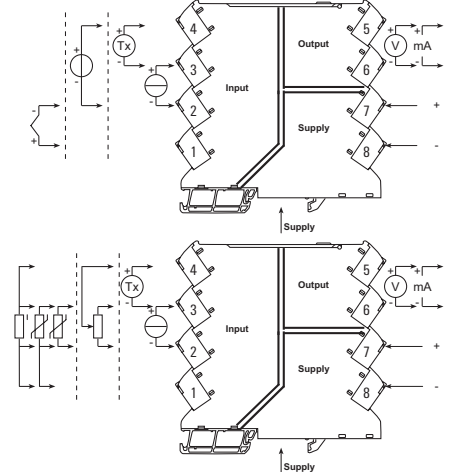
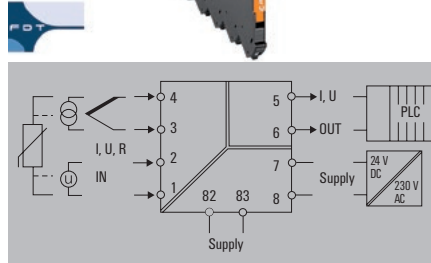

### Technical data

Input	
Sensor	
Potentiometer	
Resistance	
Input current	
Input voltage	
Input resistance, voltage	
Voltage drop, current input	
Sensor supply	
Output	
Output current	
Output voltage	
Load impedance current	
load impedance voltage	
General data	
Configuration	
Voltage supply	
Ambient temperature	
Accuracy	
Temperature coefficient	
Power consumption, typ.	
Power consumption, max.	
Step response time	
Insulation coordination	
Insulation voltage	
Rated voltage	
EMC standards	
Pollution degree	
Overvoltage category	
Approvals	
Dimensions	
Clamping range (nominal / min. / max.)	mm <sup>2</sup>
Depth x width x height	mm
Note	

Thermocouples: B / C / E / J / K / L / N / R / S / T / W3 / W5 - 200...+ 2300 °C depending on thermocouple, RTD: PT10, PT20, PT50, PT100, PT250, PT300, PT400, PT500, PT1000, Ni50, Ni100, Ni120, Ni1000, 2-/3-/4-wire	
10...100 kΩ	
0...10 kΩ	
configurable, 0...20 mA, 4...20mA	
configurable, 0(2)...10 V, 0(1)...5 V, 0...1 V DC, 0,2...1 V DC	
< 3 V	
> 15 V DC at 20 mA	
configurable, 0...20 mA, 4...20 mA, 20...0 mA, 20...4 mA, downscale (3,5 mA), upscale (23 mA), in case of sensor error	
configurable, 0(2)...10 V, 0(1)...5 V, 0(0,2)...1 V, 1...(0,2)0 V, 5...(1)0 V, 10...(2)0 V, downscale (0 V), upscale (11 V), in case of sensor error	
≤ 600 Ω, @ max 28mA	
≥ 10 kΩ	
With FDT/DTM software	
24 V DC ± 30 %	
-25 °C...70 °C	
< 0.1 % of measuring range	
≤ 0.01 % / °C	
1 W	
1.2 W	
400 ms (10...90%) @ U/I, 1 s @ temp	
2.5 kV <sub>eff</sub> / 1 min.	
300 V <sub>eff</sub>	
IEC 61326-1, NE 21	
2	
II	
cULus; DETNORVER; DNVGL; EAC; FMEX; IECEXKEM; KEMAATEX	
Screw connection	
2.5 / 0.5 / 2.5	
114.3 / 6.1 / 112.5	
Power supply optionally over the DIN mounting rail CH20M	

### Electrical connections

Terminal	ACT20M-UI-A0-S						Power supply	Output
	V	mA	mA Loop	RTD				
1				Sense- Sense-				
2	<input type="checkbox"/>	<input type="checkbox"/>		R	R-	R-	<input type="checkbox"/>	
3		<input checked="" type="checkbox"/>		R	R+	R+		
4	<input checked="" type="checkbox"/>			Sense+ R				
5							<input checked="" type="checkbox"/>	<input checked="" type="checkbox"/>
6							<input type="checkbox"/>	<input type="checkbox"/>
7							<input checked="" type="checkbox"/>	
8							<input type="checkbox"/>	

= +  
 = -

### Ordering data

Screw connection

Type	Qty.	Order No.
ACT20M-UI-A0-S	1	1176030000

### Note

### Accessories

#### Note

CBX200 USB configuration adapter - 8978580000  
DIN mounting rail, see Accessories



# Signal converters in terminal format – MCZ

---

<b>Signal converters in terminal format – MCZ</b>	Introduction	F.2
	Selection table	F.4
	Frequency signal isolator	F.6
	Threshold monitoring	F.7
	Passive isolator	F.8
	Temperature transducer	F.9

---

# Isolate and convert signals at the interface level

## MCZ signal converter in terminal format

The MCZ-SERIES signal converters have a slim terminal design and convert, isolate and monitor analogue signals. They have five tension clamp connections. The open side of the housing can be closed using a standard cover plate accessory. The housing has a low height of just 6.3 cm. It also accommodates a cross-connector for reducing the wiring of multiple module's 24 V and 0 V connections. Two WS10/6-markers can be used for labelling. These are available in MultiCard format and can be printed using Weidmüller's professional printing system.

### F

#### Your special advantages:

##### Slim design

At the interface level signals are often connected to machine-oriented or customer-specific encoders. These should be individually adapted. The typical terminal block design of the MCZ signal converter allows it to be used on site instead of the corresponding modular terminal, thus allowing external analogue signals to be individually isolated and processed.

**Saves space in the electrical cabinet**  
High product density (modules only 6 mm wide) reduces space taken on the DIN rail.

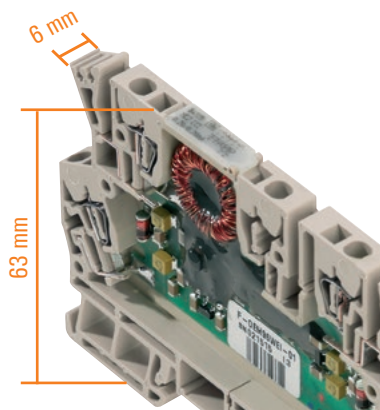



**Security**

Electrical isolation increases the safety of operations and reduces the risk of facility malfunctions.

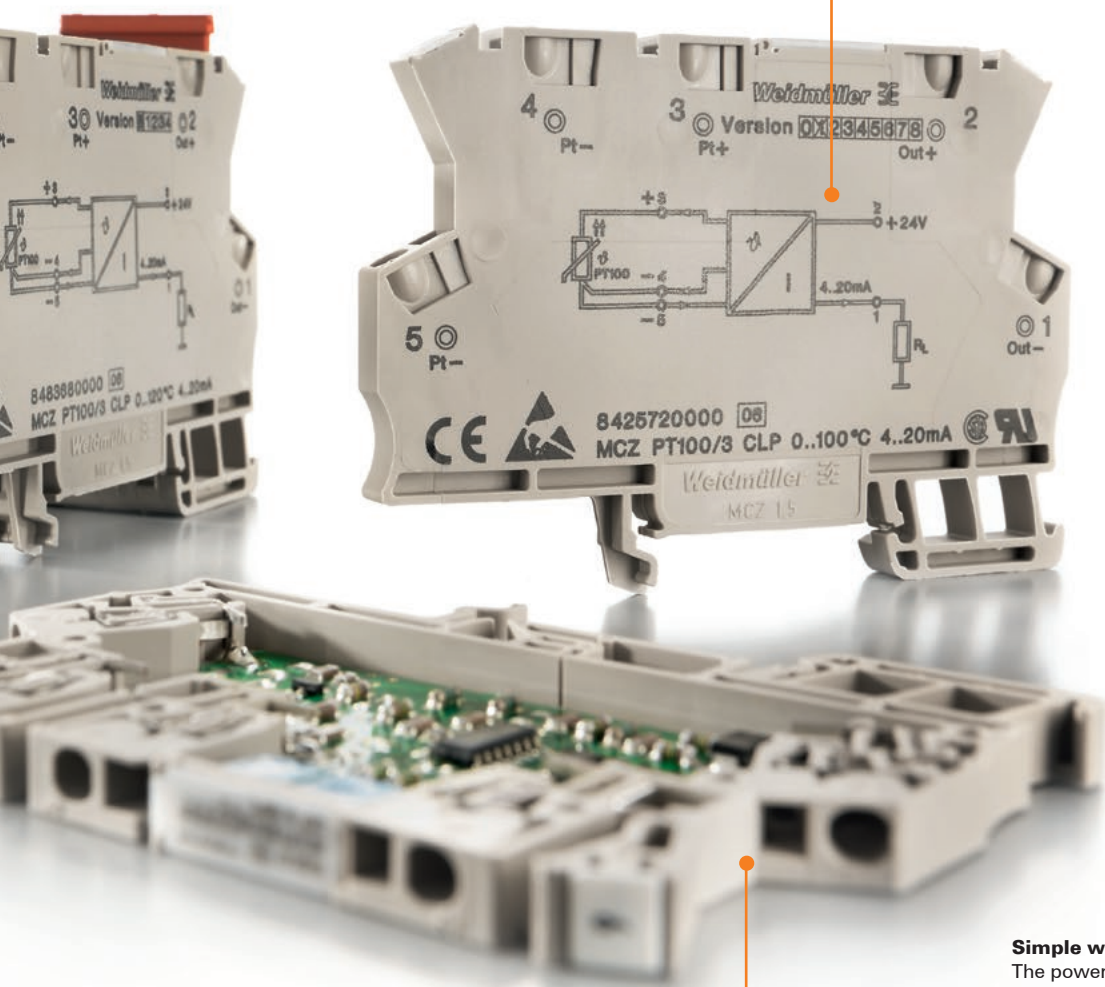
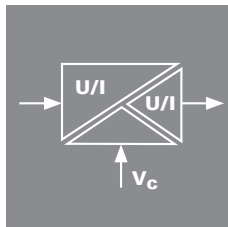

**Simple wiring**

The power supply can easily be bridged from one module to the next using pluggable cross-connections.

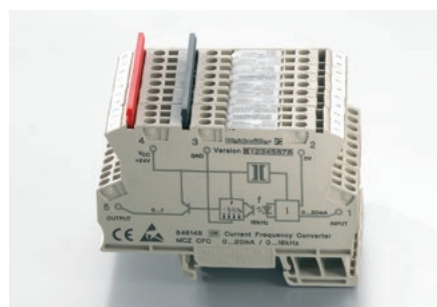

# Selection table

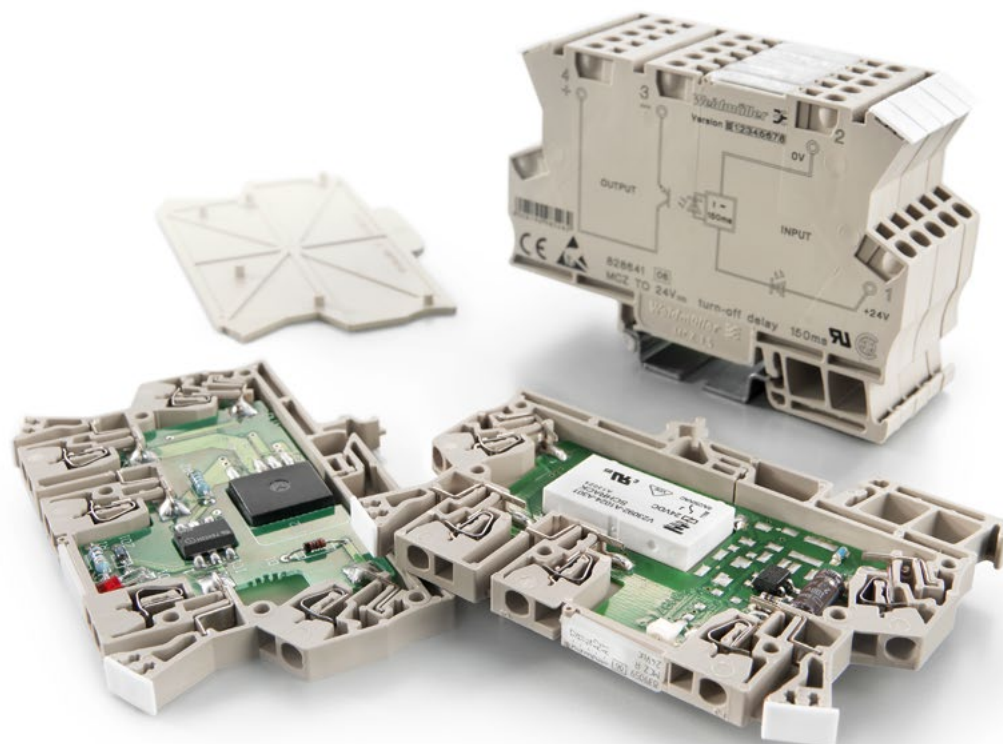

## Selection table

Order No.	Product	Input								Miscellaneous	Sensor feed	Width
		Amount	0...20 mA	4...20 mA	0...10 V	0...5 V	TC	RTD	Frequency			
<b>Signal converters in terminal format - MCZ</b>												
<b>Frequency signal converters</b>												
8461470000	MCZ VFC 0-10V	1			X					4-wire sensor		6 mm
8461480000	MCZ CFC 0-20MA	1	X							4-wire sensor		6 mm
8461490000	MCZ CFC 4-20MA	1		X						4-wire sensor		6 mm
<b>Limit monitoring</b>												
8260280000	MCZ SC 0-10V	1			X					4-wire sensor		6 mm
8227350000	MCZ SC 0-20MA	1	X							4-wire sensor		6 mm
<b>Passive isolators</b>												
8411190000	MCZ CCC 0-20mA/0-20mA	1	X							4-wire sensor		6 mm
<b>Temperature transducer</b>												
8425720000	MCZ PT100/3 CLP 0...100C	1						X		Measuring range 0...100°C		6.1 mm
8483680000	MCZ PT100/3 CLP 0...120C	1						X		Measuring range 0...120°C		6.1 mm
8604420000	MCZ PT100/3 CLP 0...150C	1						X		Measuring range 0...150°C		6.1 mm
8473010000	MCZ PT100/3 CLP 0...200C	1						X		Measuring range 0...200°C		6.1 mm
8473020000	MCZ PT100/3 CLP 0...300C	1						X		Measuring range 0...300°C		6.1 mm
8473000000	MCZ PT100/3 CLP -50C...+150C	1						X		Measuring range -50...150°C		6.1 mm
8604430000	MCZ PT100/3 CLP -40C...100C	1						X		Measuring range -40...100°C		6.1 mm

Amount	0...20 mA	4...20 mA	0...10 V	Relay	Output	Configuration	Auxiliary power	Rated voltage	Isolation	Connection system	Special characteristics
					Miscellaneous						
1					Frequency: 0...1/ 4/ 8/ 16 kHz	DIP switch	24 V DC	100 V	2-way	Z	Frequency output
1					Frequency: 0...1/ 4/ 8/ 16 kHz	DIP switch	24 V DC	100 V	2-way	Z	Frequency output
1					Frequency: 0...1/ 4/ 8/ 16 kHz	DIP switch	24 V DC	100 V	2-way	Z	Frequency output
2					NPN output, Limit value	Potentiometer	24 V DC			Z	
2					NPN output, Limit value	Potentiometer	24 V DC			Z	
1	X						input loop	100 V	2-way	Z	Passive isolator ILP
1		X					output loop	50 V	2-way	Z	Passive converter OLP
1		X					output loop	50 V	2-way	Z	Passive converter OLP
1		X					output loop	50 V	2-way	Z	Passive converter OLP
1		X					output loop	50 V	2-way	Z	Passive converter OLP
1		X					output loop	50 V	2-way	Z	Passive converter OLP
1		X					output loop	50 V	2-way	Z	Passive converter OLP
1		X					output loop	50 V	2-way	Z	Passive converter OLP

Connection system: S = screw / Z = tension clamp / P = Push In, ILP = Input Loop Powered, OLP = Output Loop Powered

## Frequency signal isolator

### DC/f converter

The analogue input signal is converted into a configurable frequency signal. Thus analogue signals can be read by the PLC's counter inputs.

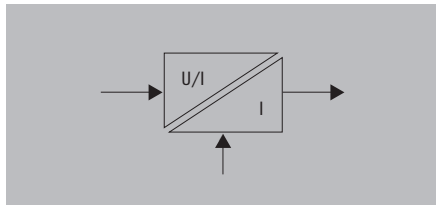

### Technical data

#### Input

Input voltage / Input current  
Input resistance, voltage/current  
Voltage drop

#### Output

Output frequency  
Output level  
Output current  
Accuracy  
Temperature coefficient  
Status indicator

#### General data

Configuration  
Voltage supply  
Current consumption  
Current-carrying capacity of cross-connect.  
Ambient temperature  
Approvals

#### Insulation coordination

Standards  
EMC standards  
Rated voltage  
Impulse withstand voltage  
Insulation voltage  
Overvoltage category  
Pollution degree  
Clearance & creepage distances

#### Dimensions

Clamping range (nominal / min. / max.) mm<sup>2</sup>  
Depth x width x height mm

#### Note

### Ordering data

Tension-clamp connection  
Tension clamp connection

#### Note

### Accessories

#### Note

### MCZ VFC

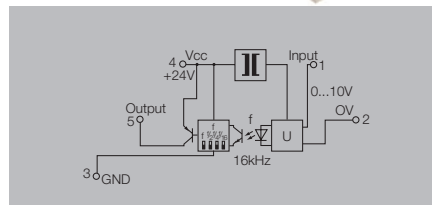
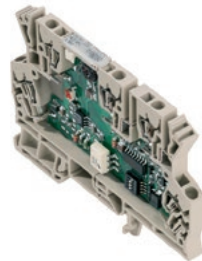

0...10 V /  
100 kΩ /

0...1/ 4/ 8/ 16 kHz

PNP, Ub-0.7 V  
max. 20 mA

0.2 % v. FSR

≤ 250 ppm/K

LED, pulsing

DIP switch

24 V DC ± 10 %

14 mA without load

≤ 20 A

0 °C...50 °C

CE, EAC

DIN EN 50178

EN 55011, EN 61000-6

100 V

1.5 kV

1 kV DC

III

2

≥ 1.5 mm

#### Tension-clamp connection

1.5 / 0.5 / 1.5  
63.2 / 6 /

### MCZ CFC

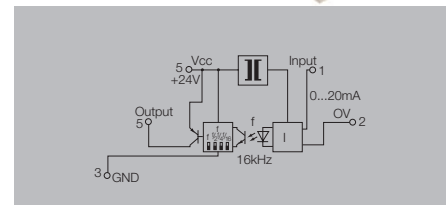
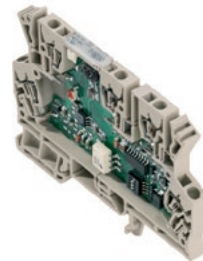

/ 0...20 mA  
/ 50 Ω  
1 V at 20 mA

0...1/ 4/ 8/ 16 kHz

PNP, Ub-0.7 V  
max. 20 mA

0.2 % v. FSR

≤ 250 ppm/K

LED, pulsing

DIP switch

24 V DC ± 10 %

14 mA without load

≤ 20 A

0 °C...50 °C

CE, EAC

DIN EN 50178

EN 55011, EN 61000-6

100 V

1.5 kV

1 kV DC

III

2

≥ 1.5 mm

#### Tension-clamp connection

1.5 / 0.5 / 1.5  
63.2 / 6 /

Without DC/DC converter input  
loop-powered

Type	Qty.	Order No.
MCZ CFC 0-20MA	10	8461480000
MCZ CFC 4-20MA	10	8461490000

MCZ CFC 0-20MA  
MCZ CFC 4-20MA

#### Note

Cross-connectors for power supplies and markers: refer to accessories

**Transistor output**

- 2 digital outputs
- Monitoring of upper and lower limit values
- 3 selectable input ranges: 300 mV...10 V, 30 mV...1 V, 10 mV...100 mV

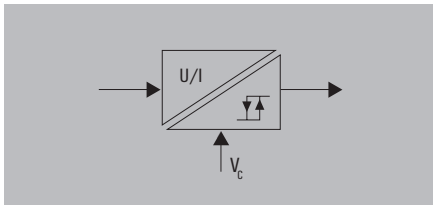

**MCZ SC 0...10 V**

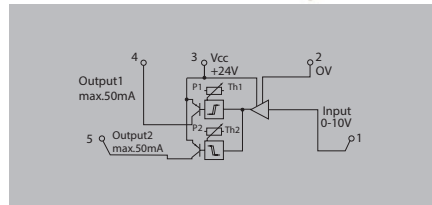
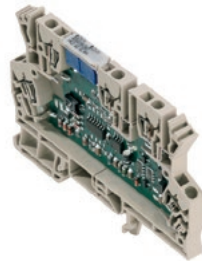

**MCZ SC 0...20 mA**

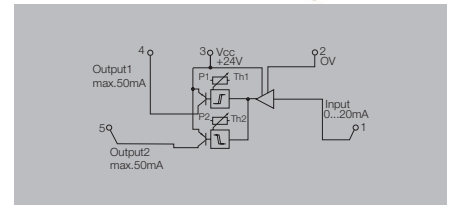
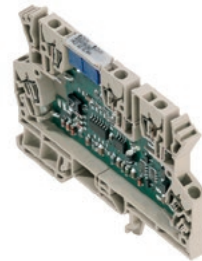

**Technical data**

<b>Input</b>	
Input voltage / Input current	0...10 V /
Input resistance, voltage/current	60 kΩ /
Voltage drop	
<b>Output</b>	
Contact assembly	Transistor output, double switch output PNP
Function	$U_{in} < U_{Th1}$ : output 1 active / $U_{in} > U_{Th2}$ : output 2 active
Switching thresholds	Via 2 potentiometers (12 turns)
Hysteresis	1% of adjusted final value
Switching current	50 mA - per channel (voltage drop at transistor: < 1.2 V at 50 mA)
Step response time	< 250 μs (switching threshold at 90% of max. input signal; $R_i \leq 1$ kΩ)
Cut-off frequency (-3 dB)	100 Hz
Temperature coefficient	max. 250 ppm/K
<b>General data</b>	
Configuration	Potentiometer
Voltage supply	24 V DC $\pm$ 20 %
Ambient temperature	0 °C...50 °C
Approvals	CE; CSA; cURus; EAC
<b>Insulation coordination</b>	
Standards	DIN EN 50178
EMC standards	EN 55011, EN 61000-6

Input voltage / Input current	/ 0.5...20 mA
Input resistance, voltage/current	/ 50 Ω
Voltage drop	1 V
<b>Output</b>	
Contact assembly	Transistor output, double switch output PNP
Function	$I_{in} < I_{Th1}$ : output 1 active; $I_{in} > I_{Th2}$ : output 2 active
Switching thresholds	Via 2 potentiometers (12 turns)
Hysteresis	1% of adjusted final value
Switching current	50 mA - per channel (voltage drop at transistor: < 1.2 V at 50 mA)
Step response time	< 250 μs (switching threshold at 90% of max. input signal; $R_i \leq 1$ kΩ)
Cut-off frequency (-3 dB)	100 Hz
Temperature coefficient	max. 250 ppm/K
<b>General data</b>	
Configuration	Potentiometer
Voltage supply	24 V DC $\pm$ 20 %
Ambient temperature	0 °C...50 °C
Approvals	CE; CSA; cURus; EAC
<b>Insulation coordination</b>	
Standards	DIN EN 50178
EMC standards	EN 55011, EN 61000-6

Input voltage / Input current	/ 0.5...20 mA
Input resistance, voltage/current	/ 50 Ω
Voltage drop	1 V
<b>Output</b>	
Contact assembly	Transistor output, double switch output PNP
Function	$I_{in} < I_{Th1}$ : output 1 active; $I_{in} > I_{Th2}$ : output 2 active
Switching thresholds	Via 2 potentiometers (12 turns)
Hysteresis	1% of adjusted final value
Switching current	50 mA - per channel (voltage drop at transistor: < 1.2 V at 50 mA)
Step response time	< 250 μs (switching threshold at 90% of max. input signal; $R_i \leq 1$ kΩ)
Cut-off frequency (-3 dB)	100 Hz
Temperature coefficient	max. 250 ppm/K
<b>General data</b>	
Configuration	Potentiometer
Voltage supply	24 V DC $\pm$ 20 %
Ambient temperature	0 °C...50 °C
Approvals	CE; CSA; cURus; EAC
<b>Insulation coordination</b>	
Standards	DIN EN 50178
EMC standards	EN 55011, EN 61000-6

<b>Dimensions</b>	
Clamping range (nominal / min. / max.)	mm <sup>2</sup>
Depth x width x height	mm
<b>Note</b>	

<b>Tension-clamp connection</b>	
1.5 / 0.5 / 1.5	
63.2 / 6 /	
<b>Note</b>	

<b>Tension-clamp connection</b>	
1.5 / 0.5 / 1.5	
63.2 / 6 /	
<b>Note</b>	

**Ordering data**

Tension clamp connection
--------------------------

Type	Qty.	Order No.
MCZ SC 0-10V	10	8260280000

Type	Qty.	Order No.
MCZ SC 0-20MA	10	8227350000

<b>Note</b>
-------------

<b>Note</b>
-------------

<b>Note</b>
-------------

**Accessories**

<b>Note</b>
-------------

Cross-connectors for power supplies and markers: refer to accessories
---

Cross-connectors for power supplies and markers: refer to accessories
---

## Passive isolator

### Input current loop feed

- Passive isolators for galvanic isolation of 0/4...20 mA standard signals.
- The component draws power from the measurement signal and requires no additional auxiliary power
- Low energy consumption, pick-up current of < 100  $\mu$ A.
- 2-way isolation

### MCZ CCC / ILP

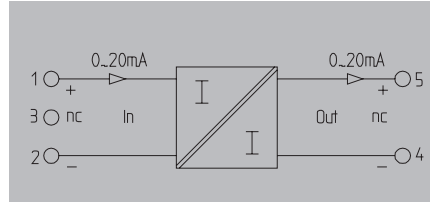
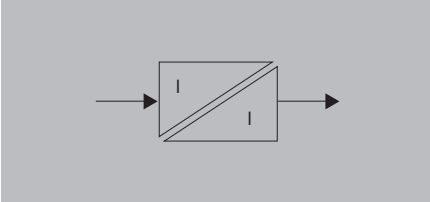

### Technical data

#### Input

Input voltage / Input current  
Pick-up current  
Voltage drop

#### Output

Output voltage / Output current  
Load impedance, voltage/current  
Accuracy  
Temperature coefficient  
Cut-off frequency (-3 dB)

#### General data

Configuration  
Ambient temperature  
Approvals

#### Insulation coordination

Standards  
EMC standards  
Insulation voltage

/ 0(4)...20 mA current loop

< 100  $\mu$ A

2.5...3 V at 20 mA

/ 0...20 mA, 4...20 mA

/  $\leq$  500  $\Omega$

< 0.1 % of end value

$\leq$  50 ppm/K of measured value at 0  $\Omega$  load resistance

100 Hz

none

-25 °C...60 °C

CE; CSA; cURus; EAC

DIN EN 60529, DIN EN 61010-1

EN 61000-6

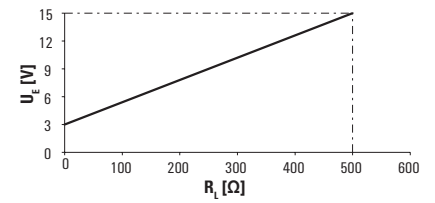

### Dimensions

Clamping range (nominal / min. / max.) mm<sup>2</sup>  
Depth x width x height mm

### Note

### Tension-clamp connection

1.5 / 0.5 / 1.5  
63.2 / 6 /

### Ordering data

Tension clamp connection

Type	Qty.	Order No.
MCZ CCC 0-20MA/0-20MA	10	8411190000

### Note

### Accessories

#### Note

Cross-connectors for power supplies and markers: refer to accessories

**RTD 2-/3-conductor converter**

**Output-loop powered**

- RTD signal converter for galvanic isolation and conversion of PT100 signals
- The component draws power from the output circuit and requires no additional auxiliary power
- 2-way isolation

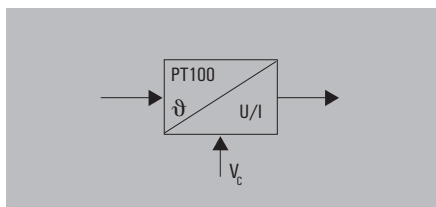

**MCZ PT100/3 CLP / OLP**

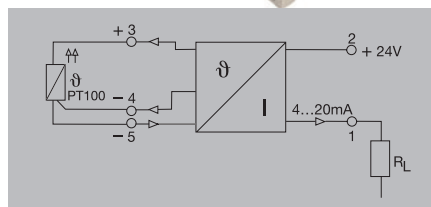

**Technical data**

<b>Input</b>
Sensor
Sensor supply
<b>Output</b>
Output current
Load impedance, voltage/current
<b>General data</b>
Configuration
Ambient temperature / Storage temperature
Accuracy
Approvals
Standards
EMC standards

PT100/2-/3-wire (in compliance with IEC 751)
0.8 mA / 9...30 V DC
4...20 mA (current loop) at 9...30V DC
/ ≤ 600 Ω
none
/ -25 °C...50 °C / -25 °C...85 °C
Typ.: 0.2 %, máx. 0.5 % v. FSR
CE; CSA; cURus; EAC
DIN EN 50178, DIN EN 61000-4-2
EN 61000-6

<b>Dimensions</b>	
Clamping range (nominal / min. / max.)	mm <sup>2</sup>
Depth x width x height	mm
<b>Note</b>	

<b>Tension-clamp connection</b>
1.5 / 0.5 / 1.5
63.2 / 6 /

**Ordering data**

0...100 °C	Tension clamp connection
0...120 °C	Tension clamp connection
0...150 °C	Tension clamp connection
0...200 °C	Tension clamp connection
0...300 °C	Tension clamp connection
-50...+150 °C	Tension clamp connection
-40...+100 °C	Tension clamp connection
<b>Note</b>	

Type	Qty.	Order No.
MCZ PT100/3 CLP 0...100C	10	8425720000
MCZ PT100/3 CLP 0...120C	10	8483680000
MCZ PT100/3 CLP 0...150C	10	8604420000
MCZ PT100/3 CLP 0...200C	10	8473010000
MCZ PT100/3 CLP 0...300C	10	8473020000
MCZ PT100/3 CLP -50C...+150C	10	8473000000
MCZ PT100/3 CLP -40C...100C	10	8604430000

**Accessories**

<b>Note</b>
-------------

Cross-connectors for power supplies and markers: refer to accessories
---





# Compact standard signal isolators – PicoPak

<b>Compact standard signal isolators – PicoPak</b>	Introduction	G.2
	Selection table	G.4
	PicoPak screw connection/PUSH IN	G.6

# Measuring and isolating without auxiliary power supply

## PicoPak - the smallest standard signal isolator

Many processes are only possible with the safe conversion and reliable separation of analogue current signals. With impressive performance, our analogue signal converter PicoPak supports the simultaneous measurement and galvanic isolation of signals from active field sensors and PLC input cards. Because of their integrated input and output current loop, the module does not require any additional auxiliary power supply and can also be easily used in remote switch boxes. Being integrated into a housing that is only 6 mm wide means that the signal converters take up very little space on a terminal rail. Both the tried-and-tested screw connectors and the convenient PUSH IN connection technology designs ensure reliable connections.

## G

### Your special advantages:

- High flexibility for a variety of applications due to worldwide approvals and an extended
- temperature range from -40 to +70°C
- Loop powered to isolate active field sensors without additional auxiliary power supply from active PLC input cards
- Reliable measurement range and zero point calibration using a potentiometer

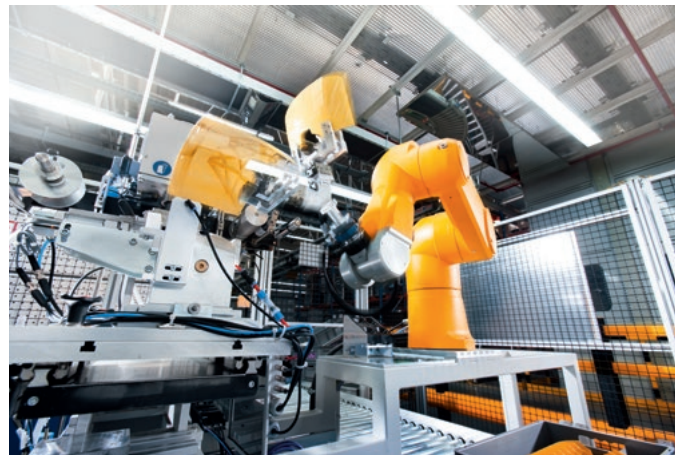

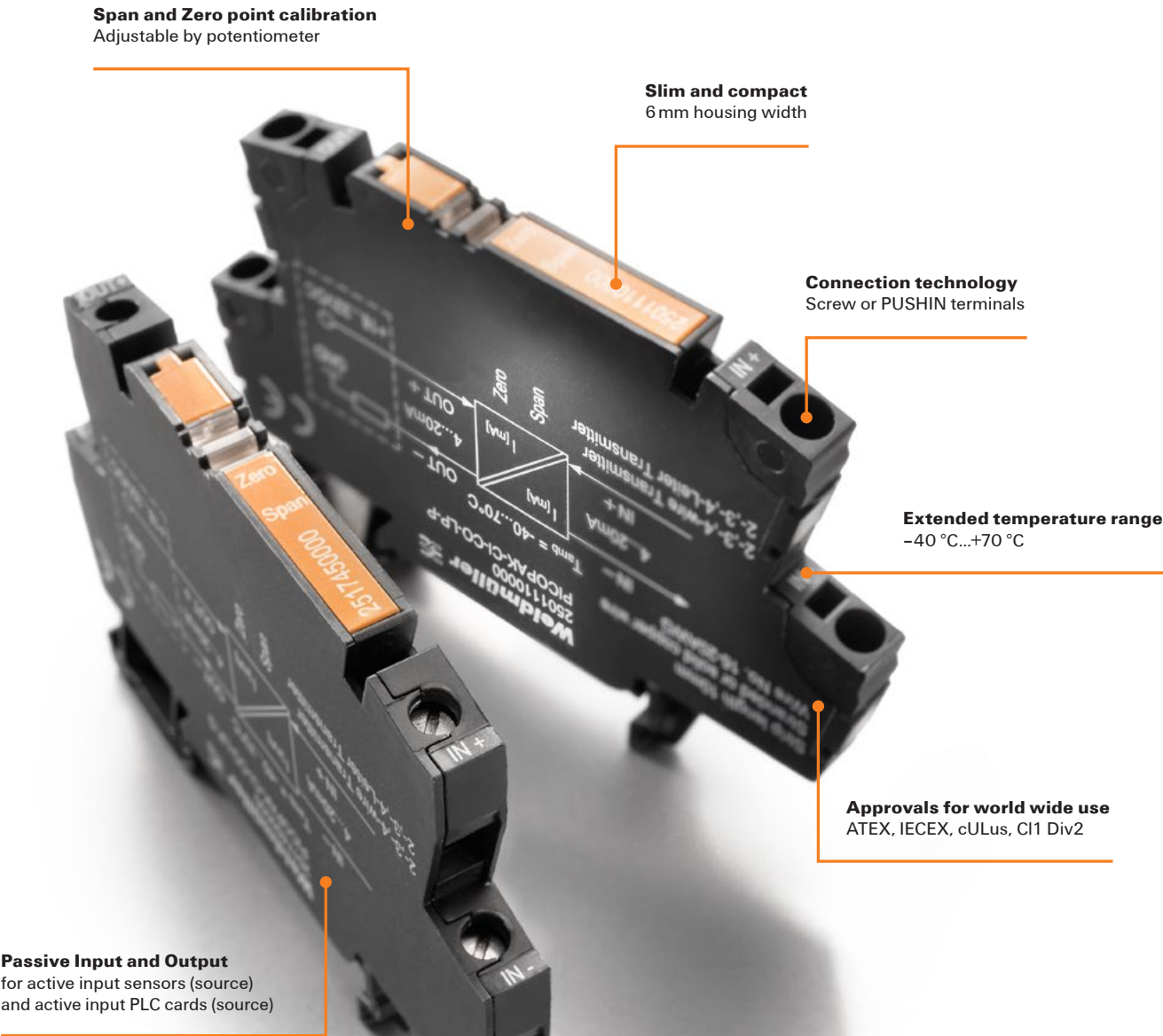

**Passive Input and Output**  
for active input sensors (source)  
and active input PLC cards (source)

**Slim and compact**  
6mm housing width

**Connection technology**  
Screw or PUSHIN terminals

**Extended temperature range**  
-40 °C...+70 °C

**Approvals for world wide use**  
ATEX, IECEX, cULus, CI1 Div2



# Selection table



## Selection table

Order No.	Product	Input								Miscellaneous	Sensor feed	Width
		Amount	0...20 mA	4...20 mA	0...10 V	0...5 V	TC	RTD	Frequency			
<b>Compact standard signal isolators - PicoPak</b>												
2517450000	PICOPAK-CI-CO-LP-S	1		X						4-wire sensor		6.1 mm
2501110000	PICOPAK-CI-CO-LP-P	1		X						4-wire sensor		6.1 mm

	Output					Configuration	Auxiliary power	Rated voltage	Isolation	Connection system	Special characteristics
	Amount	0...20 mA	4...20 mA	0...10 V	Relay						
1		X				Potentiometer	output loop	300 V	2-way	S	Passive converter, ATEX approval Zone 2, UL certified
1		X				Potentiometer	output loop	300 V	2-way	P	Passive converter, ATEX approval Zone 2, UL certified

**Connection system:** S = screw / Z = tension clamp / P = Push In, **ILP** = Input Loop Powered, **OLP** = Output Loop Powered

**PicoPak screw connection / PUSH IN**

**PicoPak**

- Loop powered at output
- Increased operating temperature range -40 °C ...+70 °C
- Zero and span adjustment possible

**PICOPAK-CI-CO-LP**

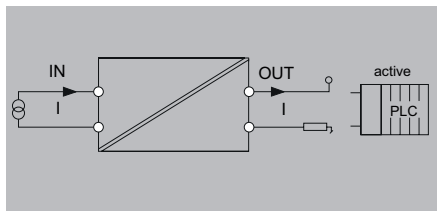

**Technical data**

<b>Input</b>
Number of inputs
Input current
Sensor
Voltage drop, current input
<b>Analogue outputs</b>
Load impedance current
Output current
Supply voltage (output)
<b>General data</b>
Accuracy
Configuration
Voltage supply
Step response time
Temperature coefficient
Power consumption, max.
Voltage supply
Long-term drift
<b>Insulation coordination</b>
EMC standards
Galvanic isolation
Overvoltage category
Insulation voltage
Rated voltage

1
4...20 mA
Current source
≤3,5 V
≤ 600 Ω
4...20 mA, loop-powered
18...32 V
< 0.1 % of measuring range
Potentiometer
Output loop powered
≤ 5 ms
≤ 200 ppm/K
0.8 W
Output loop powered
≤±0.05% of the measurement range / year
EN 61326-1
2-way isolator
II
3.5 kV
300 V AC <sub>max</sub>

**G**

<b>Dimensions</b>	
Clamping range (nominal / min. / max.)	mm <sup>2</sup>
Depth x width x height	mm
<b>Note</b>	

<b>Screw connection</b>	<b>PUSH IN</b>
55 / 6.1 / 79.4	55 / 6.1 / 79.4

**Ordering data**

Screw connection
PUSH IN connection

Type	Qty.	Order No.
PICOPAK-CI-CO-LP-S	1	2517450000
PICOPAK-CI-CO-LP-P	1	2501110000

**Note**

**Accessories**

**Note**

# Signal & serial interface converters – WAVESERIES

<b>Signal &amp; serial interface converters – WAVESERIES</b>	Introduction	H.2
	Selection table	H.4
	Universal measurement transducers	H.6
	Current measuring transducers	H.8
	Isolating converter for serial interfaces	H.9
	Limit value & current monitoring	H.11

# Be prepared for every application

## With the WAVESERIES signal & serial interface converters

Universal signal & serial interface converters offer a lot of benefits for signal processing. A service technician who does not have the right spare isolator or converter available and has to operate a part of the system manually for a day or two before the spare part arrives will understand this all too well. This is a waste of time and money. This is why Weidmüller has developed a signal converter with unique flexibility that combines an isolator, a converter, an encoder, a lineariser and a trip amplifier in a single module. The combination of the best features and exceptional configuration options is what makes the WAVESERIES universal signal converter unique. Designed for process industry applications, the signal converter operates accurately and stably with all common sensor types in a wide ambient temperature and power supply range. A 24 V DC power supply is provided for sensors or field devices using two-wire technology. Alternatively, the universal signal converter offers a passive loop powered input.

In addition, Weidmüller's WAVESERIES serial interface converters enable data to be exchanged between data processing systems, controllers and peripheral devices. These process converters are ideal for use in harsh, process-oriented environments. Different versions of the interface converter are available for different applications. In order to ensure high transmission reliability, the serial interface converters are designed with a high-port 4kV 3-way isolation and are galvanically isolated.





**Universal input signals:**

Temperature signals such as RTDs, thermocouples, potentiometers, frequency transmitters, DC voltage signals and current signals in one module.

**Inputs and outputs are PC-configurable**

The input and output signals are easy to configure via an interface (CBX200 USB) using a PC.

**Easy to service**

The electronic unit can be removed from the housing without using any tools.

**Secure connection**

9-pole connector for the RS232 interface

**Testing without additional wiring**

Current and voltage inputs can be tested via an additional test contact without disconnecting the existing wiring.

**High data transmission speeds**

Up to 115 kBit/s and freely adjustable

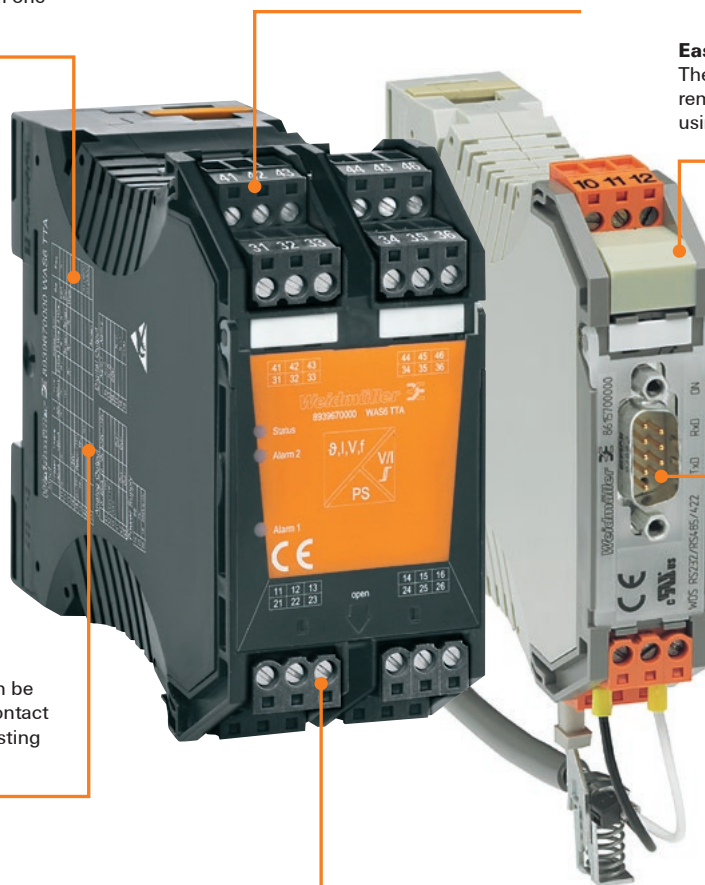

# Selection table



## Selection table

Order No.	Product	Input									Miscellaneous	Sensor feed	Width
		Amount	0...20 mA	4...20 mA	0...10 V	0...5 V	TC	RTD	Frequency				
<b>Signal &amp; serial interface converters - WAVESERIES</b>													
<b>Universal measurement transducers</b>													
8939670000	WAS6 TTA	1	X	X	X	X	X	X	X	X	-200...500 mV, T192-20...50 V, 2 Hz...100 kHz, RTD, TC, resistance, potentiometer	X	45 mm
8939680000	WAZ6 TTA	1	X	X	X	X	X	X	X	X	-200...500 mV, T192-20...50 V, 2 Hz...100 kHz, RTD, TC, resistance, potentiometer	X	45 mm
8964310000	WAS6 TTA EX	1	X	X	X	X	X	X	X	X	-200...500 mV, T192-20...50 V, 2 Hz...100 kHz, RTD, TC, resistance, potentiometer	X	45 mm
8964320000	WAZ6 TTA EX	1	X	X	X	X	X	X	X	X	-200...500 mV, T192-20...50 V, 2 Hz...100 kHz, RTD, TC, resistance, potentiometer	X	45 mm
<b>Current measuring transducers</b>													
8528650000	WAS1 CMA LP 1/5/10A ac	1									0...1/5/10 A AC		22.5 mm
8528660000	WAZ1 CMA LP 1/5/10A ac	1									0...1/5/10 A AC		22.5 mm
8975590000	WAS1 CMA LP 1/5/10A EX	1									0...1/5/10 A AC		22.5 mm
<b>Serial interface converters</b>													
8615700000	WDS2 RS232/RS485/422	1									RS232/RS485/422		22.5 mm
8615690000	WDS2 RS232/TTY	1									RS232/TTY		22.5 mm
<b>Limit &amp; current monitoring</b>													
8543820000	WAS5 DC/Alarm	1	X	X	X						4-wire sensor		17.5 mm
8543880000	WAZ5 DC/Alarm	1	X	X	X						4-wire sensor		17.5 mm
8742610000	PAS CMR 0,5...2,5 A DC										Input range 7.5 A		15.3 mm
8742620000	PAS CMR 2,0...5,0 A DC										Input range 15 A		15.3 mm
8742630000	PAS CMR 4,5...10 A DC										Input range 30 A		15.3 mm

	Output					Configuration	Auxiliary power	Rated voltage	Isolation	Connection system	Special characteristics	
	Amount	0...20 mA	4...20 mA	0...10 V	Relay							Miscellaneous
3	X	X	X	X		1 x analogue output + 2 x Limit value relay output	Software	18 V - 230 V AC/DC	300 V	3-way	S	
3	X	X	X	X		1 x analogue output + 2 x Limit value relay output	Software	18 V - 230 V AC/DC	300 V	3-way	Z	
3	X	X	X	X		1 x analogue output + 2 x Limit value relay output	Software	18 V - 230 V AC/DC	300 V	3-way	S	ATEX approval Zone 2
3	X	X	X	X		1 x analogue output + 2 x Limit value relay output	Software	18 V - 230 V AC/DC	300 V		Z	ATEX approval Zone 2
1		X					DIP switch	output loop	300 V	2-way	S	
1		X					DIP switch	output loop	300 V	2-way	Z	
1		X					DIP switch	output loop	300 V	2-way	S	ATEX approval Zone 2
1						RS232/RS485/422	DIP switch	24 V DC		3-way	S	
1						RS232/TTY	DIP switch	24 V DC		3-way	S	
2				X		2 x Limit value relay output	DIP switch, potentiometer	24 V DC	300 V	3-way	S	
2				X		2 x Limit value relay output	DIP switch, potentiometer	24 V DC	300 V	3-way	Z	
1				X		Reed contact activated from 0.5 A DC	-	-	-	2-way	S	
1				X		Reed contact activated from 2 A DC	-	-	-	2-way	S	
1				X		Reed contact activated from 4,5 A DC	-	-	-	2-way	S	

Connection system: S = screw / Z = tension clamp / P = Push In, ILP = Input Loop Powered, OLP = Output Loop Powered

## Universal measurement transducers

## WAVE TTA

- Input and outputs can be configured on PC with the TTA-SET software, download at [www.weidmueller.com](http://www.weidmueller.com)
- Universal input signals
- Loop-powered or passive input
- Pluggable connection terminals

## WAS6 TTA / WAZ6 TTA

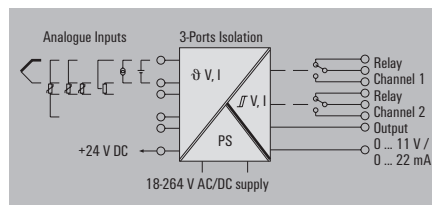

## Technical data

Input	
Sensor	
Potentiometer	
Resistance	
Input frequency	
Input voltage	
Input current	
Sensor supply	
Output analogue	
Output voltage	
Output current	
Load impedance, voltage/current	
Signal output	
Transmit function	
Output digital	
Type	
Switching voltage AC, max. / DC, max.	
General data	
Configuration	
Voltage supply	
Power consumption	
Accuracy	
Temperature coefficient	
Ambient temperature / Storage temperature	
Step response time	
Humidity	
Approvals	
Insulation coordination	
Standards	
EMC standards	
Rated voltage	
Impulse withstand voltage	
Pollution degree	
Overtoltage category	
Clearance & creepage distances	
Insulation voltage	
Dimensions	
Clamping range (nominal / min. / max.)	mm <sup>2</sup>
Depth x width x height	mm
Note	

Thermocouples: B, E, J, K, L, N, R, S, T (IEC 60584), PT100, PT1000, (EN 60571) Ni100, Ni1000, (JIS1604), Cu10, Cu25, Cu50, Cu100 (DIN 43760) 2-/3-/4-wire	
10...50 Ω, 50...100 Ω, 100...200 Ω, 200...400 Ω, 400...800 Ω, 800 Ω...2 kΩ, 2...6.5 kΩ, 6.5...100 Ω	
10 Ω...5 kΩ	
adjustable, 2 Hz...100 kHz	
-200...500 mV (min. 4 mV span), -20...50 V DC (min. 0.5 V span)	
-20...+50 mA (min. interval 0.4 mA)	
24 V DC / 22 mA	
adjustable between -10...+10 V (min. span 2.5 V)	
adjustable between 0 and 20 mA (min. span of 5 mA)	
> 10 kΩ @ 0...10 V / > 20 kΩ @ -10...+10 V / < 700 Ω	
direct or inverted	
Linear, $x^{1/2}$ , $x^{3/2}$ , $x^{5/2}$ or user-defined curve (101 points)	
2 x 1 C0 contact (hard gold-plated), Process alarms (4x) with hysteresis, with alarm delay (configurable) 0...180 s	
250 V /	
Using free Windows software, TTA Set Software	
18...264 V AC/DC	
< 3.5 W	
< 0.1 % span (DC, RTD); 0.2 % span (or 1 °C) + CJ failure	
< 0.1 % / K (DC, RTD); < 0.1 % FSR / K + CJ error 0.07 °C/K (thermocouples)	
/ -40 °C...70 °C / -40 °C...85 °C	
50 ms...1 sec (RTD, mV inputs), 110 ms...1 sec (V, mA inputs)	
5...95 %, no condensation	
CE; cULus; DNVGL; EAC	
DIN EN 50178, DIN EN 61000-4-2	
EN 55011, EN 61000-6	
300 V	
6 kV	
2	
III	
≥ 5.5 mm (1 mm input/output)	
2.5 kV	
Screw connection	
2.5 / 0.5 / 2.5	2.5 / 0.5 / 2.5
112.4 / 45 /	112.4 / 45 /
Tension-clamp connection	
2.5 / 0.5 / 2.5	2.5 / 0.5 / 2.5
112.4 / 45 /	112.4 / 45 /

## Typical functions

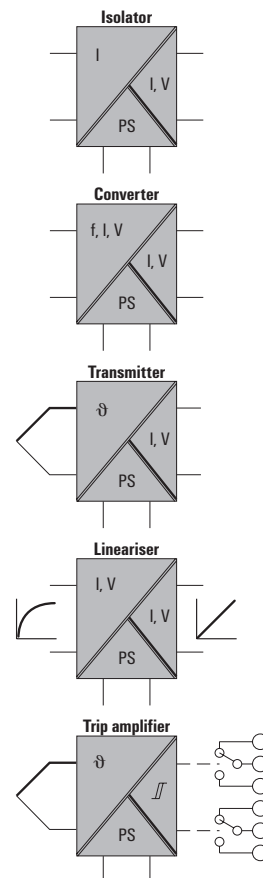

## Ordering data

Type	Qty.	Order No.
<b>Screw connection</b>		
WAS6 TTA	1	8939670000
<b>Tension-clamp connection</b>		
WAZ6 TTA	1	8939680000

CBX200 USB configuration adapter - 8978580000

WAVE TTA EX

- Input and outputs can be configured on PC with the TTA-SET software, download at www.weidmueller.com
- Universal input signals
- Loop-powered or passive input
- Pluggable connection terminals
- ATEX 3 G Ex nA IIC T4
- UL Class I, Div.2

WAS6 TTA EX / WAZ6 TTA EX

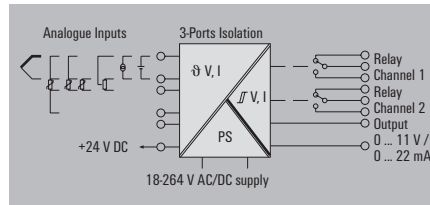

Technical data

<b>Input</b>	
Sensor	
Potentiometer	
Resistance	
Input frequency	
Input voltage	
Input current	
Sensor supply	
<b>Output analogue</b>	
Output voltage	
Output current	
Load impedance, voltage/current	
Signal output	
Transmit function	
<b>Data for Ex applications (ATEX)</b>	
Marking	
<b>Output digital</b>	
Type	
Switching voltage AC, max. / DC, max.	
<b>General data</b>	
Configuration	
Voltage supply	
Power consumption	
Accuracy	
Temperature coefficient	
Ambient temperature / Storage temperature	
Step response time	
Humidity	
Approvals	
<b>Insulation coordination</b>	
Standards	
EMC standards	
Rated voltage	
Impulse withstand voltage	
Pollution degree	
Overvoltage category	
Clearance & creepage distances	
Insulation voltage	
<b>Dimensions</b>	
Clamping range (nominal / min. / max.)	mm <sup>2</sup>
Depth x width x height	mm
<b>Note</b>	

Thermocouples: B, E, J, K, L, N, R, S, T (IEC 60584), PT100, PT1000, (EN 60571) Ni100, Ni1000, (JIS1604), Cu10, Cu25, Cu50, Cu100 (DIN 43760) 2-/3-/4-wire	
10...50 Ω, 50...100 Ω, 100...200 Ω, 200...400 Ω, 400...800 Ω, 800 Ω...2 kΩ, 2...6.5 kΩ, 6.5...100 Ω	
10 Ω...5 kΩ	
adjustable, 2 Hz...100 kHz	
-200...500 mV (min. 4 mV span), -20...50 V DC (min. 0.5 V span)	
-20...+50 mA (min. interval 0.4 mA)	
24 V DC / 22 mA	
adjustable between -10...+10 V (min. span 2.5 V)	
adjustable between 0 and 20 mA (min. span of 5 mA)	
> 10 kΩ @ 0...10 V / > 20 kΩ @ -10...+10 V / < 700 Ω	
direct or inverted	
Linear, x <sup>1/2</sup> , x <sup>3/2</sup> , x <sup>5/2</sup> or user-defined curve (101 points)	
II 3 G Ex nA nC IIC T4 Gc	
2 x 1 CO contact (hard gold-plated), Process alarms (4x) with hysteresis, with alarm delay (configurable) 0...180 s	
250 V /	
Using free Windows software, TTA Set Software	
24...240 V AC/DC; 24...36 V AC / 24...50 V DC (ATEX Zone 2)	
< 3.5 W	
< 0.1 % span (DC, RTD); 0.2 % span (or 1 °C) + CJ failure	
< 0.1 % / K (DC, RTD); < 0.1 % FSR / K + CJ error 0.07 °C/K (thermocouples)	
/ -40 °C...70 °C / -40 °C...85 °C	
50 ms...1 sec (RTD, mV inputs), 110 ms...1 sec (V, mA inputs)	
5...95 %, no condensation	
CE; cULus; cULusEX; EAC; WATEXIECEX	
DIN EN 50178, DIN EN 60079, DIN EN 61000-4-2	
EN 55011, EN 61000-6	
300 V	
6 kV	
2	
III	
≥ 5.5 mm (1 mm input/output)	
2.5 kV	
<b>Screw connection</b>	<b>Tension-clamp connection</b>
2.5 / 0.5 / 2.5	2.5 / 0.5 / 2.5
112.4 / 45 /	112.4 / 45 /

Typical functions

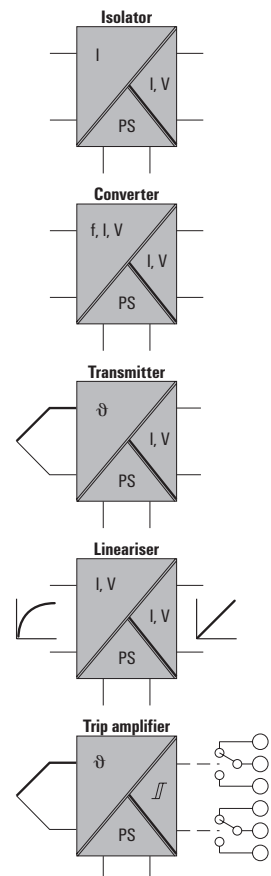

Ordering data

Type	Qty.	Order No.
<b>Screw connection</b>		
WAS6 TTA EX	1	8964310000
<b>Tension-clamp connection</b>		
WAZ6 TTA EX	1	8964320000

CBX200 USB configuration adapter - 8978580000

**Current measuring transducers**

**Analogue output**

- Monitors AC currents
- Input and output are electrically isolated
- Input and output ranges adjustable via DIP switch

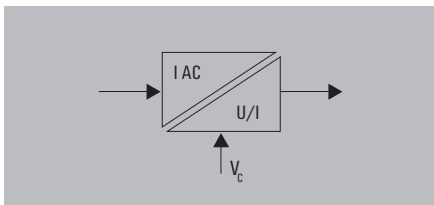

**Technical data**

Input	
Input current	0...1 A AC/ 0...5 A AC/ 0...10 A AC
Input frequency	50...60Hz
Max. current	100 A for 1s
Voltage of measuring circuit	250 V AC
Sensor	

Output	
Output current / Output voltage	4...20 mA (current loop) /
Offset current	max. 100 µA
Output signal limit	Approx. 24 mA
Load impedance, voltage/current	/ ≤ 600 Ω
Accuracy	0.5 % FSR
Temperature coefficient	≤ 200 ppm/K
Status indicator	LED ON: OK; LED flashing: signal out of range; LED OFF: Error

General data	
Configuration	DIP switch
Voltage supply	13...30 V DC, via output current loop
Step response time	typ. 700 ms
Ambient temperature / Storage temperature	/ 0 °C...50 °C / -20 °C...70 °C
Default setting	0...5 A AC, 4...20 mA
Approvals	CE; cULus; EAC

Insulation coordination	
Standards	DIN EN 50178 (secure separation)
EMC standards	EN 55011, EN 61000-6
Rated voltage	300 V
Impulse withstand voltage	6 kV
Pollution degree	2
Overvoltage category	III
Clearance & creepage distances	≥ 5.5 mm
Insulation voltage	4 kV <sub>eff</sub> / 5 s

Dimensions	
Clamping range (nominal / min. / max.)	mm <sup>2</sup>
Depth x width x height	mm

**Note**

**Ordering data**

	Screw connection
	Tension clamp connection

**Note**

**Accessories**

**Note**

**1/5/10 A AC 4...20 mA**

Loop-powered

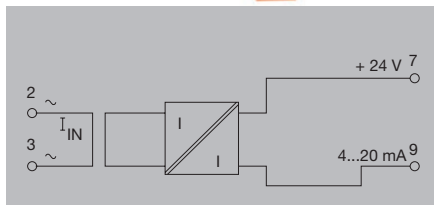

Input current	0...1 A AC/ 0...5 A AC/ 0...10 A AC
Input frequency	50...60Hz
Max. current	100 A for 1s
Voltage of measuring circuit	250 V AC

Output current / Output voltage	4...20 mA (current loop) /
Offset current	max. 100 µA
Output signal limit	Approx. 24 mA
Load impedance, voltage/current	/ ≤ 600 Ω
Accuracy	0.5 % FSR
Temperature coefficient	≤ 200 ppm/K
Status indicator	LED ON: OK; LED flashing: signal out of range; LED OFF: Error

Configuration	DIP switch
Voltage supply	13...30 V DC, via output current loop
Step response time	typ. 700 ms
Ambient temperature / Storage temperature	/ 0 °C...50 °C / -20 °C...70 °C
Default setting	0...5 A AC, 4...20 mA
Approvals	CE; cULus; EAC

Standards	DIN EN 50178 (secure separation)
EMC standards	EN 55011, EN 61000-6
Rated voltage	300 V
Impulse withstand voltage	6 kV
Pollution degree	2
Overvoltage category	III
Clearance & creepage distances	≥ 5.5 mm
Insulation voltage	4 kV <sub>eff</sub> / 5 s

Screw connection	
Clamping range (nominal / min. / max.)	mm <sup>2</sup>
Depth x width x height	mm

**Note**

Type	Qty.	Order No.
WAS1 CMA LP 1/5/10A AC	1	8528650000
WAZ1 CMA LP 1/5/10A AC	1	8528660000

**Note**

Cross-connectors for power supplies and markers - refer to Accessories

**1/5/10 A AC 4...20 mA**

Loop-powered

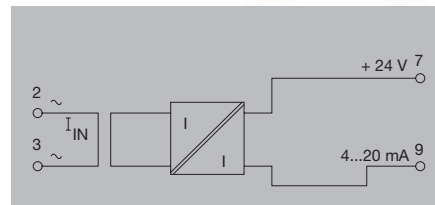

Input current	0...1 A AC/ 0...5 A AC/ 0...10 A AC
Input frequency	50...60Hz
Max. current	100 A for 1s
Voltage of measuring circuit	250 V AC

Output current / Output voltage	4...20 mA (current loop) /
Offset current	max. 100 µA
Output signal limit	Approx. 24 mA
Load impedance, voltage/current	/ ≤ 600 Ω
Accuracy	0.5 % FSR
Temperature coefficient	≤ 200 ppm/K
Status indicator	LED ON: OK; LED flashing: signal out of range; LED OFF: Error

Configuration	DIP switch
Voltage supply	13...30 V DC, via output current loop
Step response time	typ. 700 ms
Ambient temperature / Storage temperature	/ 0 °C...50 °C / -20 °C...70 °C
Default setting	0...5 A AC, 4...20 mA
Approvals	CE; cULusEX; EAC

Standards	DIN EN 50178 (secure separation)
EMC standards	EN 55011, EN 61000-6
Rated voltage	300 V
Impulse withstand voltage	6 kV
Pollution degree	2
Overvoltage category	III
Clearance & creepage distances	≥ 5.5 mm
Insulation voltage	4 kV <sub>eff</sub> / 5 s

Screw connection	
Clamping range (nominal / min. / max.)	mm <sup>2</sup>
Depth x width x height	mm

**Note**

Type	Qty.	Order No.
WAS1 CMA LP 1/5/10A EX	1	8975590000

**Note**

Cross-connectors for power supplies and markers - refer to Accessories

**RS232/RS485/422**

- 3-way isolation
- RS232 connection via SUB-D 9
- RS485/422, shield connection via KLBUE
- Switchable DTE or DCE assignment
- Bi-directional communication

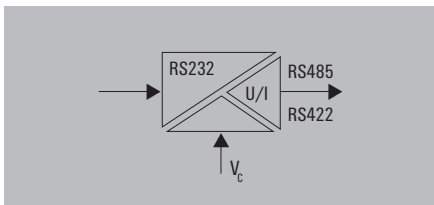

**RS232/RS485/422**

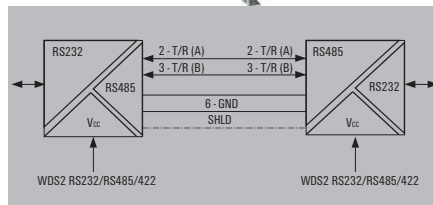

**Technical data**

<b>RS232</b>
Connection type / Input current
Assignment
<b>RS485/422</b>
Terminating resistors
Type of connection
Bit distortion
Bit delay
Control of data direction
Shield connection
Status indicator
Transmission rate
Transmission channels
Transmission distance
<b>General data</b>
Configuration
Voltage supply
Power consumption
Ambient temperature
Approvals
<b>Insulation coordination</b>
Standards
EMC standards
Rated voltage
Impulse withstand voltage
Pollution degree
Overvoltage category
Clearance & creepage distances
Insulation voltage

SUB-D9 (male plug) /
DTE/DCE switchable with DIP switch
Pull-down/pull-up via DIP switch
Screw connection
< 5 %
≤ 3 µs
Automatic or via RS232 RTS/CTS
KLBÜ 4-6/Z1
LED green: supply voltage, TxD, RxD
2.4, 4.8, 9.6, 19.2, 57.6, 115.2 kBaud, 8 bit or 8 bit + parity bit
Half-duplex (RS485 2-wire)
Full-duplex (RS485 4-wire and RS422)
Max. 1200 m twisted pair
DIP switch
24 V DC ± 20 %
ca. 1.5 W
0 °C...55 °C
BURVER; CE; cULus; DNVGL; EAC
DIN EN 50178, DIN EN 61000-4-2
EN 55011, EN 61000-6-2, EN 61000-6-4
between adjacent electric circuits: 300 V
between electric circuits and PE: 150 V
4 kV
2
III
Between neighbouring circuits: 3 mm
Between the circuits and PE: 1.5 mm
2 kV DC / 1 min.

<b>Dimensions</b>	
Clamping range (nominal / min. / max.)	mm <sup>2</sup>
Depth x width x height	
<b>Note</b>	

<b>Screw connection</b>
2.5 / 0.5 / 2.5
/ 22.5 / 112.4
<b>Note</b>

**Ordering data**

Screw connection
------------------

Type	Qty.	Order No.
WDS2 RS232/RS485/422	1	8615700000

<b>Note</b>
-------------

**Accessories**

<b>Note</b>
-------------

<b>Note</b>
-------------

Cross-connector for power supplies and markers - refer to Accessories
---

Isolating converter for serial interfaces

RS232/TTY

- 3-way isolation
- RS232 connection via SUB-D 9
- TTY shield connection via KLBUE retaining clip
- Switchable DTE or DCE assignment
- Bi-directional communication

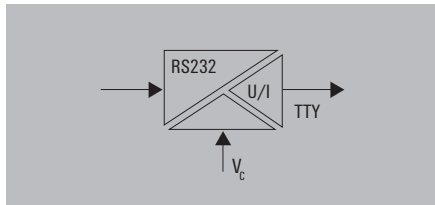

RS232/TTY

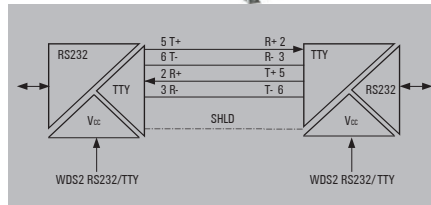

Technical data

RS232

Connection type / Input current  
Assignment

TTY

Type of connection  
Bit distortion  
Bit delay  
Load  
Shield connection  
Status indicator  
Transmission rate  
Transmission channels  
Transmission distance

General data

Configuration  
Voltage supply  
Power consumption  
Ambient temperature  
Storage temperature  
Approvals

Insulation coordination

Standards  
EMC standards  
Rated voltage  
  
Impulse withstand voltage  
Pollution degree  
Overvoltage category  
Clearance & creepage distances  
  
Insulation voltage

SUB-D9 (male plug) /  
DTE/DCE switchable with DIP switch

Screw connection  
< 1.5%  
≤ 3 μs

≤ 500 Ω  
KLBÜ 4-6/Z1  
LED green: supply voltage, TxD, RxD  
19.2 kBit/s  
Full-duplex  
Max. 1000 m twisted pair

DIP switch  
24 V DC ± 20 %  
ca. 0.8 W  
0 °C...55 °C  
-20 °C...85 °C  
CE; cULus; DNVGL

DIN EN 50178, DIN EN 61000-4-2  
EN 55011, EN 61000-6-2, EN 61000-6-4  
between adjacent electric circuits: 300 V  
between electric circuits and PE: 150 V  
4 kV  
2  
III  
Between neighbouring circuits: 3 mm  
Between the circuits and PE: 1.5 mm  
2 kV DC / 1 min.

Dimensions

Clamping range (nominal / min. / max.) mm<sup>2</sup>  
Depth x width x height

Note

Screw connection

2.5 / 0.5 / 2.5  
/ 22.5 / 112.4

Ordering data

Screw connection

Type	Qty.	Order No.
WDS2 RS232/TTY	1	8615690000

Note

Accessories

Note

Cross-connector for power supplies and markers – refer to Accessories



**Relay output**

- 3-way isolation
- Low trip / high trip
- FAILSAFE / NON-FAILSAFE
- 2 relay outputs 250 V AC / 3 A

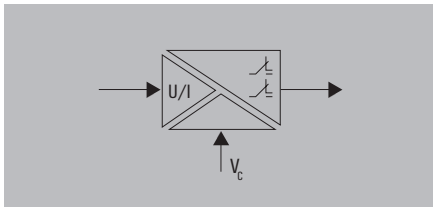

**DC/Alarm**

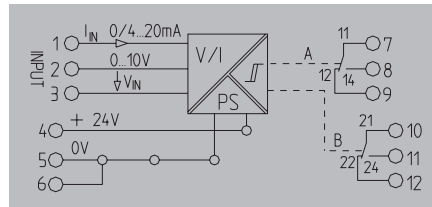

**Technical data**

Input	
Input voltage	0...10 V
Input current	0(4)...20 mA
Input resistance, voltage/current	≥ 100 kΩ / ≤ 110 Ω
Output	
Type	2 CO contacts, Open or closed-circuit principle
Contact material	AgNi 90/10
Switching thresholds	1...90 % (independently for channel 1 and channel 2)
Hysteresis	1...10 % (independent for channel 1 and channel 2)
Max. switching voltage, AC	250 V
Continuous current	3 A
Function	Open-circuit/closed-circuit principle
Temperature coefficient	≤ 500 ppm/K
Status indicator	LED green ON: OK, LED red ON: alarm (per channel)
General data	
Configuration	DIP switch, Potentiometer
Voltage supply	24 V DC ± 25 %
Power consumption	Typ.: 1 W both relays picked up
Current-carrying capacity of cross-connect.	≤ 2 A
Ambient temperature	0 °C...55 °C
Default setting	Channel A/B: low trip and FAILSAFE
Approvals	CE; cULus
Insulation coordination	
Standards	DIN EN 50178
EMC standards	EN 61000-4-2, -3, -4, -5, -6
Rated voltage	300 V
Impulse withstand voltage	4 kV
Pollution degree	2
Overvoltage category	III
Clearance & creepage distances	≥ 3 mm
Insulation voltage	2 kV <sub>eff</sub> / 5 s

Dimensions	
Clamping range (nominal / min. / max.)	mm <sup>2</sup>
Length x width x height	mm
Note	

**Ordering data**

	Screw connection
	Tension clamp connection
Note	

**Accessories**

Note
------

Screw connection		Tension-clamp connection	
2.5 / 0.5 / 2.5	1.5 / 0.5 / 2.5	92.4 / 17.5 /	92.4 / 17.5 /

Type	Qty.	Order No.
WAS5 DC/ALARM	1	8543820000
WAZ5 DC/ALARM	1	8543880000

Note
------

**Switch position/setting options**

function	SW 1			
	1	2	3	4
Channel A High Trip	■			
Channel A Low Trip	□			
Channel B High Trip		■		
Channel B Low Trip		□		
FAILSAFE, Channel 1 & 2			□	□
NON FAILSAFE, Chan. 1 & 2			■	■

- = on
- = off
- NON FAILSAFE:** The relay picks up when the alarm is triggered
- FAILSAFE:** The relay drops out when the alarm is triggered. An alarm is also triggered in the FAILSAFE mode, if for example, the operating voltage to the modules fails
- Low Trip:** Alarm is triggered if the signal is under the threshold.
- High Trip:** Alarm is triggered if the signal is over the threshold.
- Signal threshold:** Adjustments of the signal threshold (1...90%) are made for channel 1 with the potentiometer P1, and separately for channel 2 via potentiometer P2.
- Hysteresis:** Adjustments of the hysteresis (1...10%) are made for channel 1 with the potentiometer P3, and separately for channel 2 via potentiometer P3.

**WAVEANALOG DC/Alarm - Alarm indication**

**Example 1**

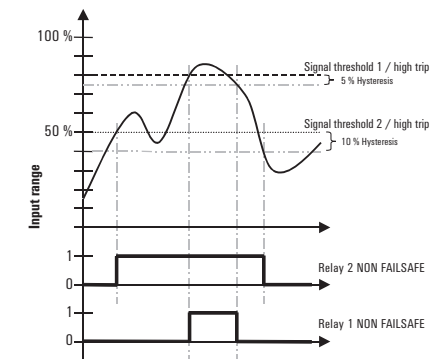

**Example 2**

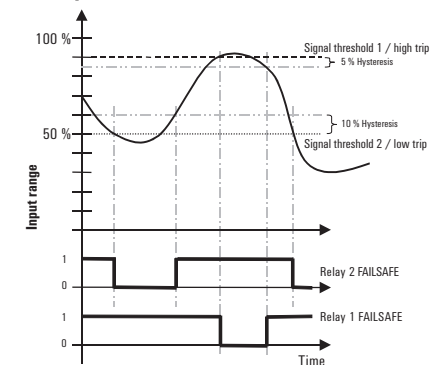

## Limit value &amp; current monitoring

## Relay output

- Monitors currents up to 10 A DC
- Used with valves, servo-controls or DC motors
- Pull-up / pull-down resistor 4.7 k $\Omega$

## PAS CMR 0.5...2.5 A DC

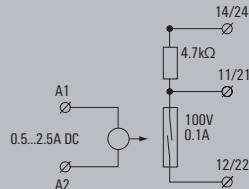

## PAS CMR 2.0...5.0 A DC

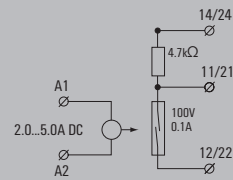

## Technical data

Input	
Input current	0.5...2.5 A DC
Max. current	7.5 A for 10 s
Making current threshold	≤ 500 mA
Input resistance, current	< 50 m $\Omega$
Secure off	≤ 50 mA
Pulse duration	min. 1 ms
Output	
Switching current	100 mA
Switching voltage AC / Switching voltage DC	/ 1 V...100 V1 V...100 V
Max. switching frequency	15 Hz
Contact assembly	1 NO contact
Contact material	RH/Rd (Reed contact)*
General data	
Configuration	none
Ambient temperature	0 °C...55 °C
Humidity	5-95% relative humidity, T <sub>v</sub> = 40°C, without condensation
Approvals	CE; cULus
Insulation coordination	
Standards	DIN EN 50178 (secure separation)
EMC standards	EN 55011, EN 61000-6-1, 2, 3, 4
Rated voltage	300 V
Impulse withstand voltage	6 kV
Insulation voltage	4 kV <sub>eff</sub> / 1 min.
Overvoltage category	III
Pollution degree	2
Clearance & creepage distances	≥ 5 mm (grout encapsulated)

Input current	0.5...2.5 A DC
Max. current	7.5 A for 10 s
Making current threshold	≤ 500 mA
Input resistance, current	< 50 m $\Omega$
Secure off	≤ 50 mA
Pulse duration	min. 1 ms
Switching current	100 mA
Switching voltage AC / Switching voltage DC	/ 1 V...100 V1 V...100 V
Max. switching frequency	15 Hz
Contact assembly	1 NO contact
Contact material	RH/Rd (Reed contact)*
Configuration	none
Ambient temperature	0 °C...55 °C
Humidity	5-95% relative humidity, T <sub>v</sub> = 40°C, without condensation
Approvals	CE; cULus
Standards	DIN EN 50178 (secure separation)
EMC standards	EN 55011, EN 61000-6-1, 2, 3, 4
Rated voltage	300 V
Impulse withstand voltage	6 kV
Insulation voltage	4 kV <sub>eff</sub> / 1 min.
Overvoltage category	III
Pollution degree	2
Clearance & creepage distances	≥ 5 mm (grout encapsulated)

Input current	2...5.0 A DC
Max. current	15 A for 10 s
Making current threshold	≤ 2 A
Input resistance, current	< 50 m $\Omega$
Secure off	≤ 300 mA
Pulse duration	min. 1 ms
Switching current	100 mA
Switching voltage AC / Switching voltage DC	/ 1 V...100 V1 V...100 V
Max. switching frequency	15 Hz
Contact assembly	1 NO contact
Contact material	RH/Rd (Reed contact)*
Configuration	none
Ambient temperature	0 °C...55 °C
Humidity	5-95% relative humidity, T <sub>v</sub> = 40°C, without condensation
Approvals	CE; cULus
Standards	DIN EN 50178 (secure separation)
EMC standards	EN 55011, EN 61000-6-1, 2, 3, 4
Rated voltage	300 V
Impulse withstand voltage	6 kV
Insulation voltage	4 kV <sub>eff</sub> / 1 min.
Overvoltage category	III
Pollution degree	2
Clearance & creepage distances	≥ 5 mm (grout encapsulated)

Dimensions	
Clamping range (nominal / min. / max.)	mm <sup>2</sup>
Length x width x height	mm
Note	

Screw connection	
Clamping range (nominal / min. / max.)	mm <sup>2</sup>
Length x width x height	mm
Note	

Screw connection	
Clamping range (nominal / min. / max.)	mm <sup>2</sup>
Length x width x height	mm
Note	

## Ordering data

Type	Qty.	Order No.
PAS CMR 0.5...2.5 A DC	10	8742610000

Type	Qty.	Order No.
PAS CMR 2.0...5.0 A DC	10	8742620000

Type	Qty.	Order No.
PAS CMR 2.0...5.0 A DC	10	8742620000

## Note

## Accessories

Note
Cross-connectors and markers - refer to WAVESERIES accessories

Note
Cross-connectors and markers - refer to WAVESERIES accessories

Note
Cross-connectors and markers - refer to WAVESERIES accessories

**Relay output**

- Monitors currents up to 10 A DC
- Used with valves, servo-controls or DC motors
- Pull-up / pull-down resistor 4.7 k $\Omega$

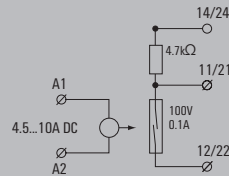
**PAS CMR 4.5...10 A DC****Technical data****Input**

Input current  
Max. current  
Making current threshold  
Input resistance, current  
Secure off  
Pulse duration

4.5...10 A DC  
30 A for 10 s  
 $\leq 4,5$  A  
 $< 50$  m $\Omega$   
 $\leq 600$  mA  
min. 1 ms

**Output**

Switching current  
Switching voltage AC / Switching voltage DC  
Max. switching frequency  
Contact assembly  
Contact material

100 mA  
/ 1 V...100 V1 V...100 V  
15 Hz  
1 NO contact  
RH/Rd (Reed contact)\*

**General data**

Configuration  
Ambient temperature  
Humidity  
Approvals

none  
0 °C...55 °C  
5-95% relative humidity,  $T_a = 40^\circ\text{C}$ , without condensation  
CE, cULus

**Insulation coordination**

Standards  
EMC standards  
Rated voltage  
Impulse withstand voltage  
Insulation voltage  
Overvoltage category  
Pollution degree  
Clearance & creepage distances

DIN EN 50178 (secure separation)  
EN 55011, EN 61000-6-1, 2, 3, 4  
300 V  
6 kV  
4 kV<sub>eff</sub> / 1 min.  
III  
2  
 $\geq 5$  mm (grout encapsulated)

**Dimensions**

Clamping range (nominal / min. / max.) mm<sup>2</sup>  
Length x width x height mm

**Screw connection**

1.5 / 2.5 / 2.5  
92 / 15.3 / 95

**Note**

\* The peak current should be limited to 100 mA when under capacitive loads.

**Ordering data**

Screw connection

Type	Qty.	Order No.
PAS CMR 4,5...10 A DC	10	8742630000

**Note****Accessories****Note**

Cross-connectors and markers - refer to WAVESERIES accessories



# Process value displays

---

<b>Process value displays</b>	Introduction	I.2
	Process value displays with LED display	I.4
	Process value displays with LCD display	I.10

---

# Process value displays

With its process instruments, Weidmüller offers you a comprehensive range of innovative products for analogue signal processing. This range is specially designed for the demanding and complex requirements of modern process automation. The product series ranges from simple dedicated units to complex microprocessor-controlled devices, and can therefore be used with almost all signal types and all common measurement sensors. The products also offer a wide range of integrated functions. These include time delays, adjustable thresholds, high/low trip switching behaviour and display scaling.



## Selection table

Order No.	Product	Input								Miscellaneous	Sensor feed	Width
		Amount	0...20 mA	4...20 mA	0...10 V	0...5 V	TC	RTD	Frequency			
<b>Process value displays</b>												
7940012323	PTX8000 RO/AO	1								NAMUR, PNP/NPN, TTL-Logic, 0...10 Hz		97 mm
7940011133	PTX8000	1								NAMUR, PNP/NPN, TTL-Logic, 0...10 Hz		97 mm
7940014374	PTX800A 4-20MA/RO/AO	1								-24...+24 mA / -11...+11 V		97 mm
7940010243	PTX800A 4-20MA	1								-24...+24 mA / -11...+11 V		97 mm
7940018957	PMX420PLUS	1	X	X	X	X						97 mm
7940018956	PMX420	1	X	X	X	X		0				97 mm
7940011979	PMX400HZX RO/AO	1					0	X		NAMUR, PNP/NPN, TTL-Logic		97 mm
7940015595	PMX400HZX	1						X		NAMUR, PNP/NPN, TTL-Logic		97 mm
7940011570	DI350 0-10V/0-100.0	1			X							97 mm
7940010185	DI350 4-20MA/0-100.0	1		X								97 mm
7940010236	LPD450F 4-20MA	1		X								140 mm
7940010163	LPD350 4-20MA/0-100.0	1		X								97 mm

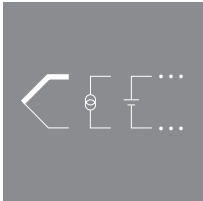

### All-purpose

A fitting solution for any application – with a multitude of input ranges, external of input loop-powered supply, and analogue or digital outputs.



### Saves time

Easy push-button configuration.



### Security

No additional signal isolation is required since there is a high insulation voltage.



### Protection

IP 65 protection allows for use in harsh industrial conditions.

	Amount	Output				Miscellaneous	Configuration	Auxiliary power	Rated voltage	Isolation	Connection system	Special characteristics
		0...20 mA	4...20 mA	0...10 V	Relay							
	1	X	X	X	X	Display with 8 Digits	Buttons on the device	24 V DC	300 V	3-way	S	
	1				X	Display with 8 Digits	Buttons on the device	24 V DC	300 V	3-way	S	
	1	X	X	X	X	Display with 8 Digits	Buttons on the device	24 V DC	300 V	3-way	S	
	1				X	Display with 8 Digits	Buttons on the device	24 V DC	300 V	3-way	S	
					X	4 x Relays, Display with 4 Digits	Buttons on the device	24 V DC	300 V	3-way	S	
						Display with 4 Digits	Buttons on the device	18...50 V DC	300 V	3-way	S	
	1	X	X	X	X	2 x Relays, Display with 4 Digits	Buttons on the device	24 V DC	300 V	3-way	S	
	1				X	2 x Relays, Display with 4 Digits	Buttons on the device	24 V DC	300 V	3-way	S	
						Display with 4,5 Digits 0...100%	Buttons on the device	24 V DC	300 V	3-way	S	
						Display with 4,5 Digits 0...100%	Buttons on the device	24 V DC	300 V	3-way	S	
						Display with 4,5 Digits 0...100%	Buttons on the device	loop powered			S	
						Display with 4,5 Digits 0...100%	Buttons on the device	loop powered			S	

Connection system: S = screw / Z = tension clamp / P = Push In, ILP = Input Loop Powered, OLP = Output Loop Powered

## Process value displays with LED display

### PTX800 Series

Counter and totaliser with additional functionality and limit-value monitoring

- Installation in control panels
- Pluggable connection terminals
- Scalable impulse and frequency counters for digital input signals
- Suitable on input side for all standard initiators

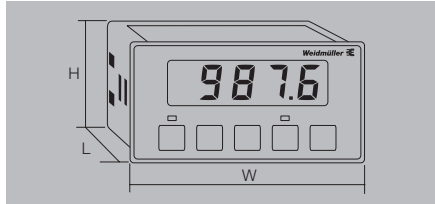

#### Technical data

<b>Input</b>
Type
Input signal
Sensor supply
Input voltage
Total display, display range
<b>Analogue output (optional)</b>
Type (analogue output)
<b>Input reset</b>
Pulse duration, min.
<b>Pulse output</b>
Pulse rate, max.
<b>General data</b>
Type
EMC standards
Approvals

### PTX800D

Digital pulse input

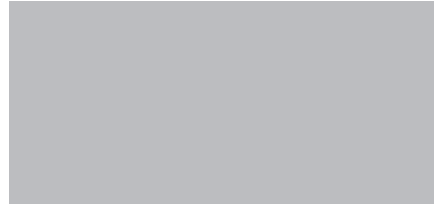

Digital pulse (NAMUR, PNP/NPN, TTL logic, optocoupler, voltage pulse, no-voltage contacts)
0...10 Hz
12 V DC to 25 mA
50 mV...250 V adjustable
Configurable (≤ 10 pulse per signal jump)
Current of voltage output, configured with jumper
100 ms
16 / s
RO/AO version with 1 analogue output and 2 alarm outputs
DIN EN 61326
CE; cULus

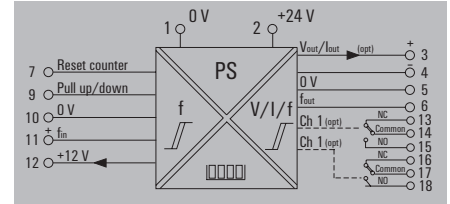

#### Connections

Terminal	Signal	
7	Reset by connection to class 12	Reset
8	Setup configuration by connection to class 12	Configuration
9	Pull Up / Down	
10	Signal - / 0 V	
11	Signal +	
12	12 V DC	

<b>Dimensions</b>	
Clamping range (nominal / min. / max.)	mm <sup>2</sup>
Length x width x height	mm
<b>Note</b>	

<b>Screw connection</b>
1.5 / 0.5 / 2.5
137 / 96.6 / 48.8

#### Ordering data

with analogue/alarm output
without analogue/alarm output

Type	Qty.	Order No.
PTX800D RO/AO	1	7940012323
PTX800D	1	7940011133

<b>Note</b>
-------------

#### Accessories

<b>Note</b>
-------------



### PTX800 Series

Counter and totaliser with additional functionality and limit-value monitoring

- Installation in control panels
- Pluggable connection terminals
- Configurable for analogue current and voltage signals
- Linearisation and interference suppression
- Power supply for external sensors

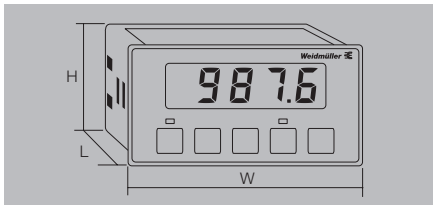

#### Technical data

<b>Input</b>	
Type	
Input signal	
Sensor supply	
Resolution	
Input resistance	
Total display, display range	
<b>Analogue output (optional)</b>	
Type (analogue output)	
<b>Input reset</b>	
Pulse duration, min.	
<b>Pulse output</b>	
Pulse rate, max.	
<b>General data</b>	
Type	
EMC standards	
Approvals	

### PTX800A

Analogue current input / voltage input



	Conversion of linear/quadratic input signals into analogue signals
	-24...+24 mA / -11...+11 V
	24 V DC (up to 25 mA)
	0.6 $\mu$ , A / 0.3 mV
	22 $\Omega$ (current input); 1 M $\Omega$ (voltage input)
	0.001; 0.01; 0.1; 1; 10; 100; 1000
	Current of voltage output, configured with jumper
	250 ms
	15 / s
	RO/AO version with 1 analogue output and 2 alarm outputs
	DIN EN 61326
	CE; cULus

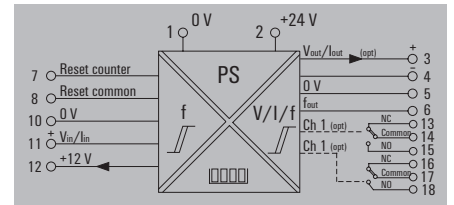

#### Connections

Terminal	Signal	
7	Reset by connection to class Kl. 8	Reset
8	Common	
9	Setup configuration by connection to class 8	Configuration
10	Signal - / 0 V	Inputs
11	Signal +	
12	24 V DC	

<b>Dimensions</b>	
Clamping range (nominal / min. / max.)	mm <sup>2</sup>
Length x width x height	mm
<b>Note</b>	

<b>Screw connection</b>	
	1.5 / 0.5 / 2.5
	137 / 96.6 / 48.8
<b>Note</b>	

#### Ordering data

	with analogue/alarm output
	without analogue/alarm output
<b>Note</b>	

Type	Qty.	Order No.
PTX800A 4-20MA/RO/AO	1	7940014374
PTX800A 4-20MA	1	7940010243

#### Accessories

<b>Note</b>	
-------------	--

## Process value displays with LED display

### PMX420 Series

Universal, 4-character current/voltage display

- Display instrument for control panel installation
- Pluggable connection terminals
- 4-character, scalable display
- Simple menu-driven configuration

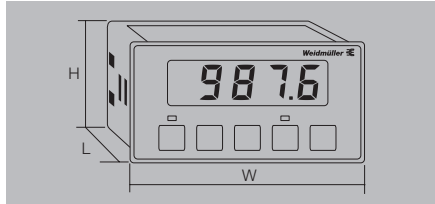

#### Technical data

Alarm	
Type	
Scaling	
Output current	
Output voltage	
Transmit function	
Load impedance, voltage/current	
Residual ripple	
Alarm	
Type	
Number of channels	
Type of contact	
Switching current	
Insulation voltage	
Leakage current quenching	

### PMX420Plus

Display with analogue output and 4 alarm channels

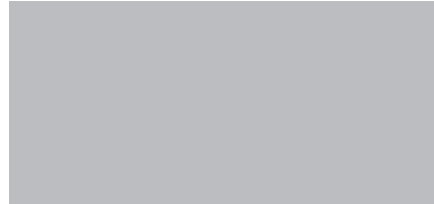

Adjustable output for current or voltage
Variable
0...22 mA
0...11 V
direct or inverted
850 Ω @ 20 mA (current output) / < 500 Ω (voltage output)
≤ 20 mV <sub>ss</sub>
Internal Alarm via LED or output signal to external controller
4
2 CO contact und 2 NO contacts
5 A @ 240 V AC, 10 A @ 24 V DC
2 kV input / power supply
internal

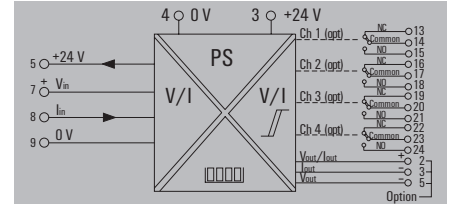

#### Connections

Terminal	Signal	
1	-	Supply voltage
2	+	High level
3	+	Supply voltage
4	-	Low level
5	Signal + sensor supply	Inputs
6	Configuration	
7	Signal + voltage input	
8	Signal + current input	
9	Signal 0 V	
10	Not used	
11	NC contact	Alarm channel 1
12	Common	
13	NO contacts	Alarm channel 2
14	NC contact	
15	Common	Alarm channel 3
16	NO contacts	
17	NO contacts	Alarm channel 4
18	Common	
19	NO contacts	Alarm channel 4
20	Common	
21	Signal +	Analogue Output
22	Signal -	

Dimensions	
Clamping range (nominal / min. / max.)	mm <sup>2</sup>
Length x width x height	mm
Note	

Screw connection	
1.5 / 0.5 / 2.5	
137 / 96.6 / 48.8	
Note	

#### Ordering data

Voltage input / current input
-------------------------------

Type	Qty.	Order No.
PMX420PLUS	1	7940018957

Note
------

#### Accessories

Note
------

### PMX420 Series

Universal, 4-character current/voltage display

- Display instrument for control panel installation
- Pluggable connection terminals
- 4-character, scalable display
- Simple menu-driven configuration

### PMX420

Display

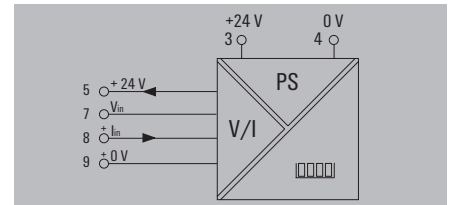
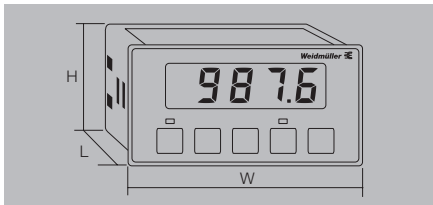

#### Technical data

Display	
Type	4-digit, red LED, 14.2 mm
Scaling	Variable
Display range	-9999...9999
Status indicator	
Inputs	
Type	Adjustable input for current or voltage
Input current	-22...+22 mA (preset to 4...20 mA)
Input resistance	25 Ω (current input) or 1.5 MΩ (voltage input)
Resolution	4 μA / 2 mV
Sensor current	4...20 mA
Current output	
Transfer functions	
Power supply	
Voltage supply	18...50 V DC, other voltages on request
Input	
Attenuation factor	0...99, programmable digital filter
General data	
Sampling rate	
Linearity	< 0.05 %
Repeat accuracy	
Temperature coefficient	
Long-term drift	0.1 % / 10.000 h
Cut-off frequency (-3 dB)	5 Hz
Step response time	
Insulation coordination	
Rated voltage	
Overvoltage category	
Impulse withstand voltage	4 kV (1.2/50 μs)
Insulation voltage	2 kV input / power supply
Ambient temperature (operational)	0 °C...60 °C
Storage temperature	-25 °C...70 °C
Pollution degree	
Humidity	0...90 % (no condensation)
Dimensions	
Clamping range (nominal / min. / max.)	mm <sup>2</sup>
Length x width x height	mm
Note	

Connections		
Terminal	Signal	
1	-	Supply voltage
2	+	High level
3	+	Supply voltage
4	-	Low level
5	Signal + sensor supply	Inputs
6	Configuration	
7	Signal + voltage input	
8	Signal + current input	
9	Signal 0 V	
10	Not used	

#### Ordering data

Voltage input / current input
-------------------------------

Type	Qty.	Order No.
PMX420	1	7940018956

Note
------

#### Accessories

Note
------

## Process value displays with LED display

### PMX400 Series

- Frequency measuring and monitoring (3-wire NPN/PNP, NPN/PNP Open Collector, TTL logic, solid-state switch, potential-free contacts)
- Integrated power supply for external sensors
- Two outputs for monitoring limit-values
- De-bouncing of switched input pulses

### PMX400HZX

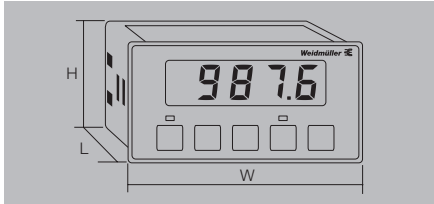

#### Technical data

<b>Display</b>	Percentage or real value display
Display value	
<b>Input</b>	Adjustable frequencies
Type	Configurable for 4 ranges
Input signal	12 V DC to 25 mA
Sensor supply	
Input voltage	
<b>Alarm (channel 1/2)</b>	Channel 1/2: transistor output
Type	channel 3/4: relay contact (CO)
Rated switching current	200 mA
Rated switching voltage	50 V DC
<b>Alarm (channel 3/4)</b>	Channel 1/2: transistor output
Type	channel 3/4: relay contact (CO)
Switching current	Channel 3/4: 3 A @ 240 V AC / 24 V DC (resistive load)
<b>General data</b>	
Voltage supply	24 V DC ± 10 %
Power consumption	6 W @ 24 V DC
Step response time	< 220 ms (10...90 %)
Attenuation factor	0...99, programmable digital filter
Type	RO/AO version with 1 analogue output and 2 alarm outputs
Insulation voltage	1 kV input / output / power supply
EMC standards	DIN EN 61326
Approvals	CE, cULus

<b>Display</b>	Percentage or real value display
Display value	
<b>Input</b>	Adjustable frequencies
Type	Configurable for 4 ranges
Input signal	12 V DC to 25 mA
Sensor supply	
Input voltage	
<b>Alarm (channel 1/2)</b>	Channel 1/2: transistor output
Type	channel 3/4: relay contact (CO)
Rated switching current	200 mA
Rated switching voltage	50 V DC
<b>Alarm (channel 3/4)</b>	Channel 1/2: transistor output
Type	channel 3/4: relay contact (CO)
Switching current	Channel 3/4: 3 A @ 240 V AC / 24 V DC (resistive load)
<b>General data</b>	
Voltage supply	24 V DC ± 10 %
Power consumption	6 W @ 24 V DC
Step response time	< 220 ms (10...90 %)
Attenuation factor	0...99, programmable digital filter
Type	RO/AO version with 1 analogue output and 2 alarm outputs
Insulation voltage	1 kV input / output / power supply
EMC standards	DIN EN 61326
Approvals	CE, cULus

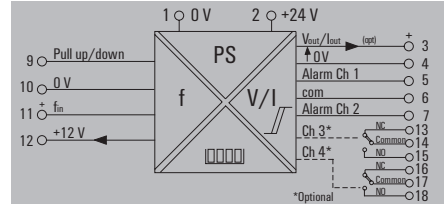

#### Connections

Terminal	Signal	
1	-	Supply voltage
2	+	
3	Signal +	Analogue output (only for AO version)
4	Signal -	
5	Common	Alarm channel 1 and 2 (only for 4RO version)
6	Channel 1	
7	Channel 2	
8	Configuration	Inputs/Configuration (Set-up: 12/8 connection)
9	Pull up / pull down	
10	Signal -	
11	Signal +	
12	12 V DC	
13	Common	Alarm channel 3 (only for 4RO version)
14	NC contact	
15	NO contacts	
16	Common	Alarm channel 4 (only for 4RO version)
17	NC contact	
18	NO contacts	

Input range	Offset	Resolution
0...9.999 Hz	0...9.998 Hz	0.001 Hz
0...99.99 Hz	0...99.98 Hz	0.01 Hz
0...999.9 Hz	0...999.8 Hz	0.1 Hz
0...9999 Hz	0...9998 Hz	1 Hz

<b>Dimensions</b>	
Clamping range (nominal / min. / max.)	mm <sup>2</sup>
Length x width x height	mm
<b>Note</b>	

<b>Screw connection</b>	
	1.5 / 0.5 / 2.5
	137 / 96.6 / 48.8
<b>Note</b>	

#### Ordering data

	with analogue/alarm output
	without analogue/alarm output
<b>Note</b>	

Type	Qty.	Order No.
PMX400HZX RO/AO	1	7940011979
PMX400HZX	1	7940015595

#### Accessories

<b>Note</b>	
-------------	--

### DI350

- Display instrument for control panel installation
- 1/8 DIN standard front
- 3½ digits
- IP 65 fully insulated
- Pluggable connection terminals

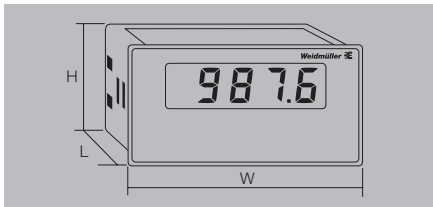

#### Technical data

Input	
Input signal	0...10 V
Input resistance	1 MΩ
Supply voltage	24 V DC (up to 25 mA)
Display	
Type	3.5 digits, red LED, 14.2 mm
Display range	-1999...1999
Display value	Percentage or real value display
Format	1-line / decimal point: 1.000, 100.0, 10.00
Settings	
Offset	± 1200 digital steps
Range of adjustment	20 - 2100 digital steps
General data	
Voltage supply	24 V DC (12...35 V DC)
Power consumption	6 W @ 24 V DC
Linearity	< 0.1 % typ.
Humidity	0...90 % (no condensation)
Temperature coefficient	≤ 0.02 % / °C
Long-term drift	0.1 % / 10.000 h
Step response time	200 ms (10...90 %)
Impulse withstand voltage	4 kV (1.2/50 μs)
Insulation voltage	1 kV input / power supply
Ambient temperature / Storage temperature	/ 0 °C...60 °C / -25 °C...70 °C
EMC standards	DIN EN 61326
Approvals	CE; cULus; cULusEX

Dimensions	
Clamping range (nominal / min. / max.)	mm <sup>2</sup>
Length x width x height	mm
Note	

#### Ordering data

Voltage input / current input	
-------------------------------	--

Note	
------	--

#### Accessories

Note	
------	--

### DI350

#### Display with voltage input



- Integrated power supply for external sensors
- Linearity with an accuracy of 0.1 % of the measuring range
- Complete galvanic isolation

Input	
Input signal	0...10 V
Input resistance	1 MΩ
Supply voltage	24 V DC (up to 25 mA)
Display	
Type	3.5 digits, red LED, 14.2 mm
Display range	-1999...1999
Display value	Percentage or real value display
Format	1-line / decimal point: 1.000, 100.0, 10.00
Settings	
Offset	± 1200 digital steps
Range of adjustment	20 - 2100 digital steps
General data	
Voltage supply	24 V DC (12...35 V DC)
Power consumption	6 W @ 24 V DC
Linearity	< 0.1 % typ.
Humidity	0...90 % (no condensation)
Temperature coefficient	≤ 0.02 % / °C
Long-term drift	0.1 % / 10.000 h
Step response time	200 ms (10...90 %)
Impulse withstand voltage	4 kV (1.2/50 μs)
Insulation voltage	1 kV input / power supply
Ambient temperature / Storage temperature	/ 0 °C...60 °C / -25 °C...70 °C
EMC standards	DIN EN 61326
Approvals	CE; cULus; cULusEX

Screw connection	
1.5 / 0.5 / 2.5	
137 / 96.6 / 48.8	
Note	

Type	Qty.	Order No.
DI350 0-10V/0-100.0	1	7940011570

Note	
------	--

Note	
------	--

### DI350

#### Display with current input



- Integrated power supply for external sensors
- Linearity with an accuracy of 0.1 % of the measuring range
- Complete galvanic isolation

Input	
Input signal	4...20 mA
Input resistance	22 Ω
Supply voltage	24 V DC (up to 25 mA)
Display	
Type	3.5 digits, red LED, 14.2 mm
Display range	-1999...1999
Display value	Percentage or real value display
Format	1-line / decimal point: 1.000, 100.0, 10.00
Settings	
Offset	± 1200 digital steps
Range of adjustment	20 - 2100 digital steps
General data	
Voltage supply	24 V DC (12...35 V DC)
Power consumption	6 W @ 24 V DC
Linearity	< 0.1 % typ.
Humidity	0...90 % (no condensation)
Temperature coefficient	≤ 0.02 % / °C
Long-term drift	0.1 % / 10.000 h
Step response time	200 ms (10...90 %)
Impulse withstand voltage	4 kV (1.2/50 μs)
Insulation voltage	1 kV input / power supply
Ambient temperature / Storage temperature	/ 0 °C...60 °C / -25 °C...70 °C
EMC standards	DIN EN 61326
Approvals	CE; cULus; cULusEX; EAC

Screw connection	
1.5 / 0.5 / 2.5	
137 / 96.6 / 48.8	
Note	

Type	Qty.	Order No.
DI350 4-20MA/0-100.0	1	7940010185

Note	
------	--

Note	
------	--

**Process value displays with LCD display**

**LPD350**

- Display instrument for control panel installation
- 1/8 DIN standard front
- 3½ digits
- IP 65 fully insulated
- Pluggable connection terminals

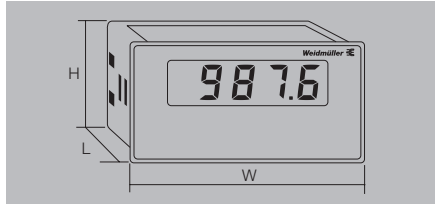

**Technical data**

<b>Input</b>
Input current
Voltage drop
Input resistance
Input current, max.
Input current, max. when wired incorrectly
<b>Display</b>
Type
Display range
Format
<b>Settings</b>
Offset
Range of adjustment
<b>General data</b>
Accuracy
Repeat accuracy
Temperature coefficient
Step response time
Sampling rate
Ambient temperature / Storage temperature
EMC standards
Approvals

**LPD350**

**Current input**

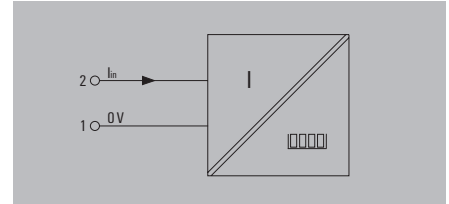
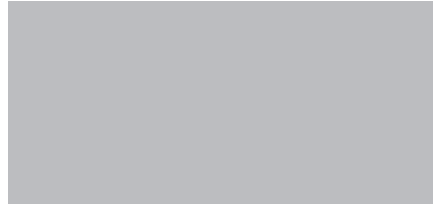

**Connections**

Terminal	Signal
1	Input -
2	Input +

4...20 mA
2.5 V @ 20 mA
125 Ω
100 mA constant / 500 mA for 10 s
500 mA constant
3.5 digits, black LCD with clear background, 12.7 mm
-1999...1999
Single-line
± 1999 digital steps in two switching ranges
0...3998 in three switching ranges
± 0.05 % from signal range ± 1 digital step
± 0.05 % of signal range
Offset ± ± 0.1 digital steps per °C
Adjustment range ± 0.1 digital steps per °C
200 ms (10...90 %)
2,5 x pro s
-20 °C...70 °C / -25 °C...85 °C
DIN EN 61326
CE; cULus; cULusEX

<b>Dimensions</b>	
Clamping range (nominal / min. / max.)	mm <sup>2</sup>
Length x width x height	mm
<b>Note</b>	

<b>Screw connection</b>
1.5 / 0.5 / 2.5
75 / 96.6 / 48.8
<b>Note</b>

**Ordering data**

Current input
---------------

Type	Qty.	Order No.
LPD350 4-20mA/0-100.0	1	7940010163

<b>Note</b>
-------------

**Accessories**

<b>Note</b>
-------------

<b>Note</b>
-------------

<b>Note</b>
-------------

**LPD450F**

- Display instrument for outdoor use
- 4½ Digits
- IP 67 fully insulated
- Optionally available with fixing clips for pipe mounting

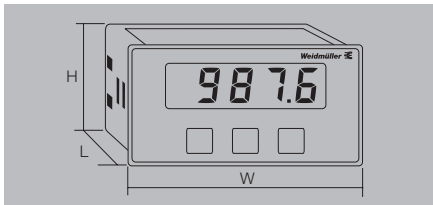

**Technical data**

<b>Input</b>	
Input current	4...20 mA
Transmit function	$\sqrt{\cdot}$ , $x^{3/2}$ , $x^{5/2}$ or programmable (2-21 steps)
<b>Display</b>	
Type	4.5-character, black LCD with clear background, 20 mm
Display value	Percentage or real value display
Display range	$\pm 19.999$ (0.00...100.00 factory setting)
Decimal point	18888, 1.8888, 18.888, 188.88, 1888.8
<b>General data</b>	
Voltage supply	Loop powered, via 4...20 mA input
Voltage drop	< 4.3 V
Accuracy	$\pm 0.05\%$ from signal range $\pm 1$ digital step
Repeat accuracy	$\pm 0.01\%$ of signal range
Temperature coefficient	Offset $\pm 0.01\%$ / °C
Humidity	Adjustment range $\pm 0.1$ digital steps or 0.01 % / °C
Step response time	10...90 %, no condensation
Sampling rate	Programmable in 99 steps from 1...30 sec.
Change of display	16 x pro s
Ambient temperature / Storage temperature	2 x per sec.
EMC standards	/ 0 °C...60 °C / -25 °C...70 °C
Approvals	DIN EN 61326
	CE; cULus; cULusEX

<b>Dimensions</b>	
Clamping range (nominal / min. / max.)	mm <sup>2</sup>
Length x width x height	mm
<b>Note</b>	

**Ordering data**

Current input
---------------

<b>Note</b>
-------------

**Accessories**

<b>Note</b>
-------------

**LPD450F**

**Current input**



<b>Input</b>	
Input current	4...20 mA
Transmit function	$\sqrt{\cdot}$ , $x^{3/2}$ , $x^{5/2}$ or programmable (2-21 steps)
<b>Display</b>	
Type	4.5-character, black LCD with clear background, 20 mm
Display value	Percentage or real value display
Display range	$\pm 19.999$ (0.00...100.00 factory setting)
Decimal point	18888, 1.8888, 18.888, 188.88, 1888.8
<b>General data</b>	
Voltage supply	Loop powered, via 4...20 mA input
Voltage drop	< 4.3 V
Accuracy	$\pm 0.05\%$ from signal range $\pm 1$ digital step
Repeat accuracy	$\pm 0.01\%$ of signal range
Temperature coefficient	Offset $\pm 0.01\%$ / °C
Humidity	Adjustment range $\pm 0.1$ digital steps or 0.01 % / °C
Step response time	10...90 %, no condensation
Sampling rate	Programmable in 99 steps from 1...30 sec.
Change of display	16 x pro s
Ambient temperature / Storage temperature	2 x per sec.
EMC standards	/ 0 °C...60 °C / -25 °C...70 °C
Approvals	DIN EN 61326
	CE; cULus; cULusEX

<b>Screw connection</b>	
Clamping range (nominal / min. / max.)	mm <sup>2</sup>
Length x width x height	mm
<b>Note</b>	

Type	Qty.	Order No.
LPD450F 4-20mA	1	7940010236

<b>Note</b>
-------------

<b>Note</b>
-------------

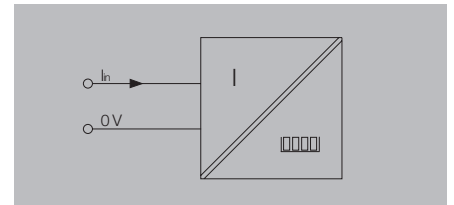

**Mounting sketch**

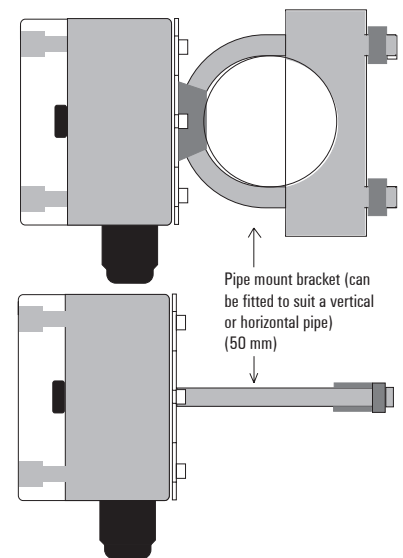





# Configuration software

---

<b>Configuration software</b>	Introduction	J.2
	FDT / FDT2	J.4

---

# Device configuration for analogue signal conditioners using FDT- and FDT2-technology

The WI-Manager is a device-management frame application which supports the FDT and FDT2 (Field Device Tool) standards. The software can be used to configure and maintain all of our configurable ACT20 devices. It can manage all device drivers that are available through their DTM (Device Type Manager). The DTM permits access to device data with a graphical user interface (GUI) that offers the user a variety of functions such as configuration, operation and monitoring of devices. WI-Manager helps to reduce the costs related to planning and maintaining the devices in a facility.

### Full FDT-functionality

The WI-Manager software provides total support for FDT and FDT2 functions. As such, it is both state-of-the-art and backwards compatible.



### Universal network topology

WI-Manager supports all communication protocols through their corresponding DTMs.

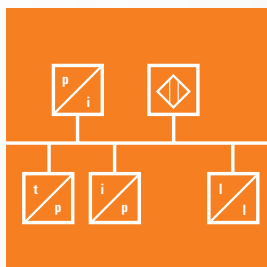

**Integrated security**

The WI-Manager user administration allows access to be limited to uncritical device functions. This increases the overall safety and security of the facility.



**Centralised data management**

Centralised administration of all available project and product data in one unified format – the result is reduced software management and data administration costs.



**Automated network planning**

Connected networks and products are automatically detected and displayed by means of the SCAN function. This makes planning and initial commissioning easier.

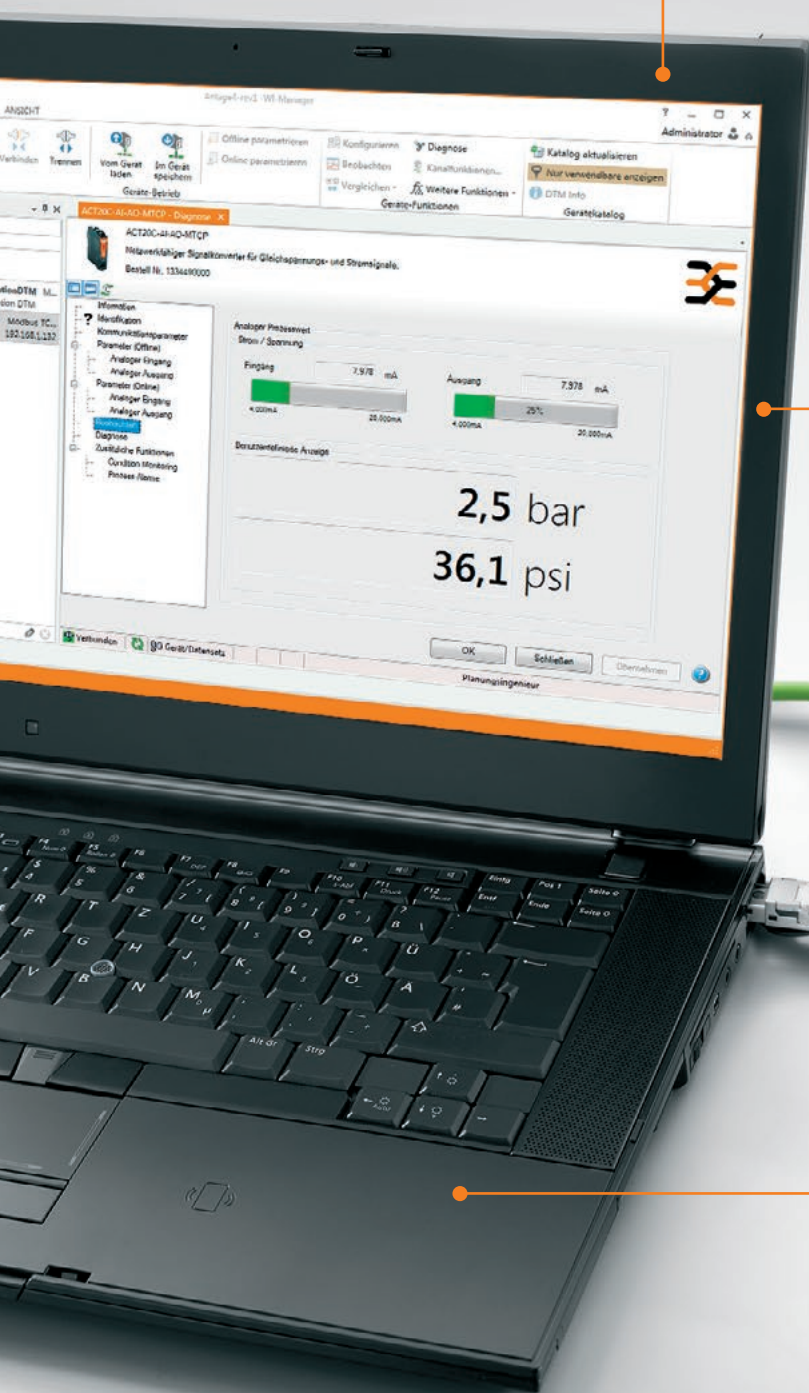
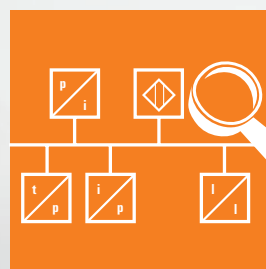

**Device configuration**



**SW Weidmueller DTM-Library Setup**

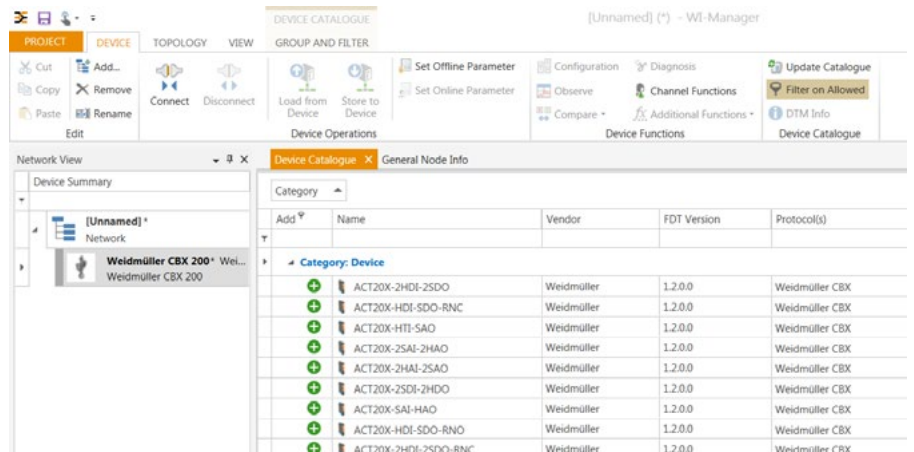

**Technical Data**

**Function and performance features**

Online constraint  
 GUI  
 Usage model software  
 Language

**System requirements**

Operating system  
 Required rights  
 Product information

No  
 Yes  
 Local installation  
 English, German

Windows 8, Windows 10  
 Admin

With the FDT / DTM software you can configure and monitor the devices of the ACT20 series. The software includes the respective Device Type Manager (DTM) as well as the FDT2.0 Frame Application WI-Manager.

Note

**Ordering Data**

Note

Type	Qty.	Order No.
SW Weidmueller DTM-Library Setup	1	1466380000

# Accessories

<b>Accessories</b>	Introduction	K.2
	USB configuration adapter	K.4
	CH20M DIN rail bus	K.6
	ACT20 power-feed modules for rail bus	K.8
	ACT20X/ACT20C/ACT20P - Accessories	K.10
	MICROSERIES/ACT20M - Accessories	K.11
	MCZ/WAVE - Accessories	K.12
	Calibrators	K.14

# Accessories

## Configure, calibrate, mount, mark, (cross-) connect.

A comprehensive line of accessories is available for the analogue signal converter product family. The line includes configuration adapters for software-programmable products, interface modules, calibrators and mounting accessories (such as cross-connectors, end plates and terminal connectors) – all naturally in the top Weidmüller quality that you’ve come to expect.



### Selection table

Order No.	Product									Input		Width
		Amount	0...20 mA	4...20 mA	0...10 V	0...5 V	TC	RTD	Frequency	Miscellaneous	Sensor feed	
<b>Accessories</b>												
896550000	ACT20-FEED-IN-PRO-S	1								24 V + 24 V redundancy		22.5 mm
245687000	ACT20-FEED-IN-PRO-P	1								24 V + 24 V redundancy		22.5 mm
128249000	ACT20-FEED-IN-BASIC-S	1								24 V		6.1 mm
897858000	CBX200 USB	1								Chinch plug		

Amount	Output				Relay	Miscellaneous	Configuration	Auxiliary power	Rated voltage	Isolation	Connection system	Special characteristics
	0...20 mA	4...20 mA	0...10 V									
1				X		24 V for CH20M bus systems + redundancy		24 V DC			S	
1				X		24 V for CH20M bus systems + redundancy		24 V DC			P	
1						24 V for CH20M bus systems		24 V DC			S	
1						Software		-			RJ45	Interface adapter for configuration

Connection system: S = screw / Z = tension clamp / P = Push In, ILP = Input Loop Powered, OLP = Output Loop Powered

## USB configuration adapter

### CBX200

- Interface converter for configuration, with galvanic isolation
- USB port for connecting to PC
- TX and RX status displays
- WI-Manager and TTA Set configuration software programs, download at [www.weidmueller.com](http://www.weidmueller.com)

### CBX200 USB



#### Technical data

Input	
Type	USB 2.0 (USB type A plug)
Input current	≤ 100 mA
Input resistance	22 kΩ
Input voltage	1.6...5.6 V
Output	
Type	RS232 (4-pole 2.5-mm jack plug)
Output voltage	3.3 V regulated
Output current	3 A
Level on interfaces	1.8...5.6 V (automatically adapted)
Baud rate	≤ 115 kBd
Activation signal	9...15 V typ. 12 V / 4 mA
Insulation coordination	
Insulation voltage	2.5 kV (input / output)

Type	USB 2.0 (USB type A plug)
Input current	≤ 100 mA
Input resistance	22 kΩ
Input voltage	1.6...5.6 V
Output	
Type	RS232 (4-pole 2.5-mm jack plug)
Output voltage	3.3 V regulated
Output current	3 A
Level on interfaces	1.8...5.6 V (automatically adapted)
Baud rate	≤ 115 kBd
Activation signal	9...15 V typ. 12 V / 4 mA
Insulation coordination	
Insulation voltage	2.5 kV (input / output)

The CBX200 USB is a USB2.0/RS232-interface converter with galvanic isolation. It has additional functionality for controlling and supplying the connected RS232 device. The CBX200 USB makes it possible to configure the intrinsically safe ACT20X product line and the WAVE TTA signal converter.  
The CBX200 USB is not compatible with the CBX100 USB.

#### Table for selecting a configuration adapter

Product	CBX100	CBX200
ACT20X		X
WAVE TTA	X	X
ITX+	X	

#### Pin assignments for jack plug



DTR*	Vcc
0	3,3 V
1	0 V

Control input	RTS*	RS232 interface
12 V	1	active
12 V	0	active
0 V	1	active
0 V	0	not active

\* RTS and DTR are internal control signals

#### Installation notes

The power supply to the device comes from the USB port via a USB type-A plug. The output-side of the RS232 interface uses a four-pole 2.5-mm jack plug to connect. This jack plug is also capable of activating the RS232 interface when needed with a 12-V control voltage. With the assistance of the DTM, the USB interface is diverted to a COM interface. The RS232 interface can be activated with an RTS signal (RTS = 1 → output activated) via the diverted COM interface. The jack plug is also capable of supplying the RS232 node with a regulated voltage of 3.3 V at 4 mA current. The DTR signal (DTR = 0 → supply activated) is used for control. It is also possible to query the status using the DSR signal (DSR = 0 → output activated).

The "WI-Manager" software, the "TTA Set" and the DTM library can all be downloaded free of charge from [www.weidmueller.com](http://www.weidmueller.com).

Note

Note

#### Ordering data

Type	Qty.	Order No.
CBX200 USB	1	8978580000

Type	Qty.	Order No.
CBX200 USB	1	8978580000

Note

Note

#### Accessories

Note

Note





# CH20M DIN rail bus

## Quick and safe power supply through the mounting rail.

This customer-friendly infrastructure solution brings power, signals and data to the rail in a quick and reliable manner. The DIN rail bus can replace the tedious individual wiring process with a flexible and uninterrupted system solution. As a result, the wiring overhead and the error rate are both reduced. The uninterrupted system bus is securely integrated within the 35 mm standard mounting rail. Whether 7.5 mm or 15 mm high, the custom-fit rail profiles are easy to install on all TS 35 standard rails in accordance with DIN EN 60715.

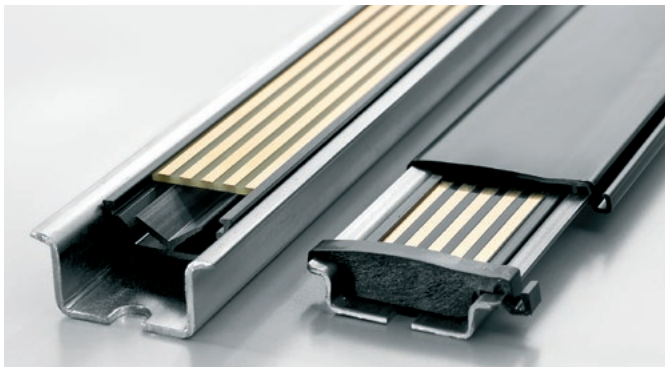

The resistant gold-plated contacts ensure a permanent and reliable contact. The ACT20M modules are simply snapped onto the mounting rail and are automatically in contact with the DIN rail bus.

The supply to the 24 V power supply can be from either one of the modules (up to 400 mA) or a separate power supply terminal (up to 4 A). This is sufficient for up to 120 modules. The ACT20-Feed-In-Basic provides a simple and compact (6 mm width) power supply terminal solution. The ACT20-Feed-In-Pro is a more powerful 22.5 mm wide solution. This makes a backup power supply that includes error messaging possible.

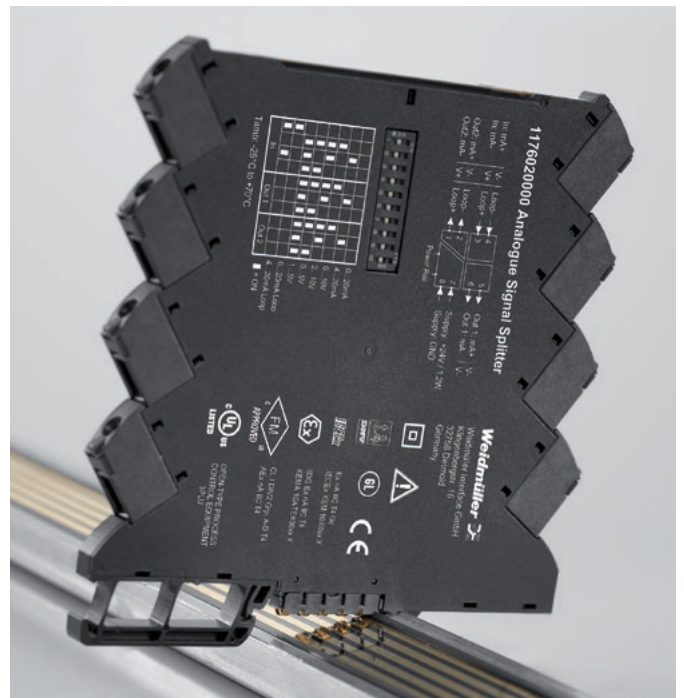

Rail bus accessories

**CH20M BUS-PROFIL TS35x7.5/1000**

Support section for bus circuit board



- Support section for TS 35 x 7.5
- Length: 250, 500 or 750 mm

Ordering data

Type	Qty.	Order No.
CH20M BUS-PROFIL TS35x7.5/250	10	1248150000
CH20M BUS-PROFIL TS35x7.5/500	10	1248160000
CH20M BUS-PROFIL TS35x7.5/750	5	1248170000

**CH20M BUS-PROFIL TS35x15/1000**

Support section for bus circuit board



- Support section for TS 35 x 15
- Length: 250, 500 or 750 mm

Ordering data

Type	Qty.	Order No.
CH20M BUS-PROFIL TS35x15/250	5	1248180000
CH20M BUS-PROFIL TS35x15/500	5	1248190000
CH20M BUS-PROFIL TS35x15/750	5	1248210000

**CH20M BUS 4.50/05 AU/1000**

Bus PCB



- Bus circuit board for use on TS 35 x 7.5 and TS 35 x 15
- Length: 250, 500 or 750 mm
- Five conductor paths, gold-plated
- Electrical rating: 63 V AC, 5 A/conductor path

Ordering data

Type	Qty.	Order No.
CH20M BUS 4.50/05 AU/250	10	1248220000
CH20M BUS 4.50/05 AU/500	10	1248230000
CH20M BUS 4.50/05 AU/750	5	1248240000

**CH20M BUS-ADP TS35/1000**

Cover plate



- Cover plate for DIN rail bus
- Length: 250, 500 or 750 mm

Ordering data

Type	Qty.	Order No.
CH20M BUS-ADP TS35/250	10	1248250000
CH20M BUS-ADP TS35/500	10	1248260000
CH20M BUS-ADP TS35/750	5	1248270000

**CH20M BUS-AP LI TS35x7.5 & 15**

End plate



- End plate for DIN rail bus
- Fits on TS 35 x 7.5 and TS 35 x 15
- left

Ordering data

Type	Qty.	Order No.
CH20M BUS-AP LI TS35x7.5 & 15	50	1193160000

**CH20M BUS-AP RE TS35x7.5 & 15**

End plate



- End plate for DIN rail bus
- Fits on TS 35 x 7.5 and TS 35 x 15
- right

Ordering data

Type	Qty.	Order No.
CH20M BUS-AP RE TS35x7.5 & 15	50	1193170000

**SET CH20M BUS 250MM TS 35X15**

Set

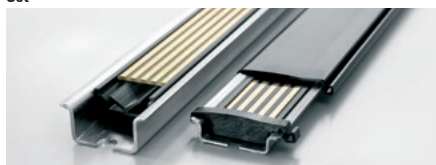

- SET consists of one each of  
CH20M BUS 4.50/05 AU/250  
CH20M BUS-ADP TS 35/250  
CH20M BUS-AP LI TS 35X7.5 & 15  
CH20M BUS-AP RE TS 35X7.5 & 15  
CH20M BUS-PROFIL TS 35X15/250

Ordering data

Type	Qty.	Order No.
SET CH20M BUS 250MM TS 35X15	1	1335150000

**SET CH20M BUS 250MM TS 35X7.5**

Set

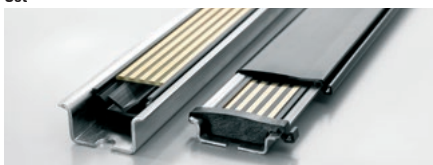

- SET consists of one each of  
CH20M BUS 4.50/05 AU/250  
CH20M BUS-ADP TS 35/250  
CH20M BUS-AP LI TS 35X7.5 & 15  
CH20M BUS-AP RE TS 35X7.5 & 15  
CH20M BUS-PROFIL TS 35X7.5/250

Ordering data

Type	Qty.	Order No.
SET CH20M BUS 250MM TS 35X7.5	1	1335140000

**TS 35x7.5 / TS 35x15**

DIN rail

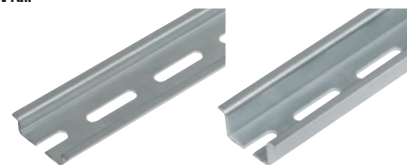

- DIN rail with slot
- Passivated galvanised steel

Ordering data

Type	Qty.	Order No.
TS 35X7.5/LL 1M/ST/ZN	10	0514510000
TS 35X15/LL 1M/ST/ZN	10	0236510000

# Power-feed module for the CH20M DIN rail bus

## 4 A supply with backup supply and error analysis

The power-feed unit ACT20-FEED-IN-PRO-S supplies the devices on the CH20M DIN rail bus with 24 V DC. At the same time, the FEED-IN device reads the group error contact – optionally provided by the installed devices – from the CH20M rail bus and sends a message through the status relay to the external controller. Optionally, two power supplies can be connected for the primary and secondary supplies (backup). An installation in Zone 2 / Division 2 is also possible. Three LEDs show the status of the power supply and the error status.

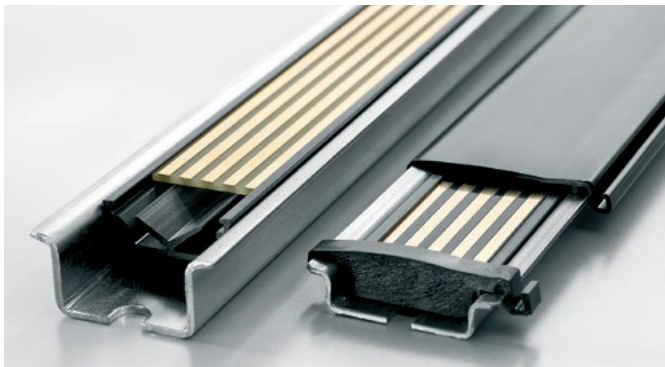

The FEED-IN-PRO can supply a maximum of 4 A to feed up to 120 devices mounted on a CH20M rail bus. Quick identification of errors on the DIN rail bus is through the internal status relay. The FEED-IN-PRO device immediately recognises and displays when a power supply has failed. The supply is then switched automatically to the redundant power supply.

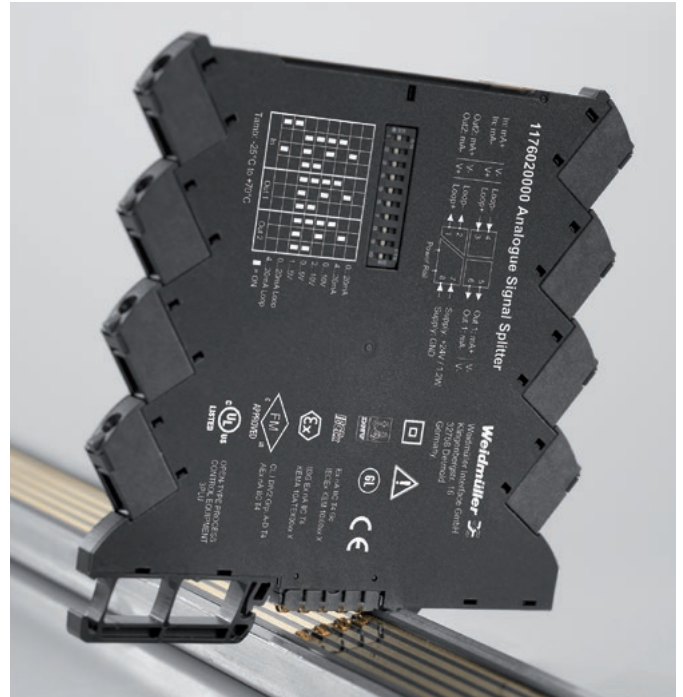

Weidmüller offers a compact and narrow 6 mm feed-in module as an alternative. This wires the terminal level directly to the DIN rail bus. Up to 80 modules can be fed with a maximum available current of 2.5 A.

**ACT20 power-feed module**

- Distributes the supply onto the busbar
- Compatible with Weidmüller CH20 DIN rail bus
- Optional connection for backup supply
- Approved for use in Ex-Zone 2 /Div. 2
- Monitoring of the supply voltage
- Alarm alerts via the status relay

**ACT20-Feed-In-PRO-S**

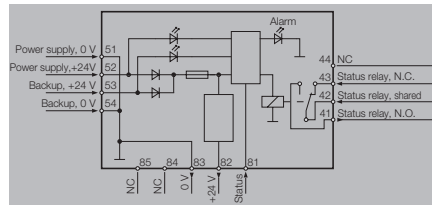

**ACT20-Feed-In-BASIC-S**

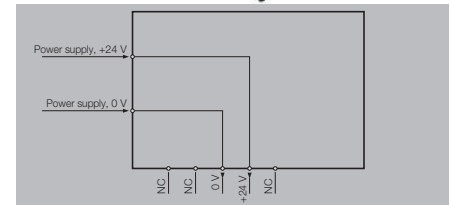

**Technical data**

<b>Input</b>	
Voltage supply	21.6...26.4 V DC
Input current	max. 4 A
Backup power supply	21.6...26.4 V DC
Trigger level for the power supply	Fault < 21 V DC
<b>Output</b>	
Output current	max. 4 A, (Supply of e.g. 110 devices of ACT20M-CI-2CO-S on one CH20M BUS)
Output power	96 W
Supply voltage (output)	24 V DC
<b>Output, status relay in safe zone</b>	
Max. switching voltage, AC / Max. switching voltage, DC	250 V /
Continuous current	2 A
AC power, max.	500 VA / 60 W
<b>General data</b>	
Degree of efficiency	0,976
Ambient temperature	-20...+60 °C
Power consumption	< 2 W
Protection degree	IP20
Weight	140
Humidity	95 %, no condensation
Approvals	cULus; DEKRAATEX; DETNORVER; EAC; FMEX; IECEXDEK

<b>Input</b>	
Voltage supply	21.6...26.4 V DC
Input current	max. 4 A
Backup power supply	21.6...26.4 V DC
Trigger level for the power supply	Fault < 21 V DC
<b>Output</b>	
Output current	max. 4 A, (Supply of e.g. 110 devices of ACT20M-CI-2CO-S on one CH20M BUS)
Output power	96 W
Supply voltage (output)	24 V DC
<b>Output, status relay in safe zone</b>	
Max. switching voltage, AC / Max. switching voltage, DC	250 V /
Continuous current	2 A
AC power, max.	500 VA / 60 W
<b>General data</b>	
Degree of efficiency	0,976
Ambient temperature	-20...+60 °C
Power consumption	< 2 W
Protection degree	IP20
Weight	140
Humidity	95 %, no condensation
Approvals	cULus; DEKRAATEX; DETNORVER; EAC; FMEX; IECEXDEK

<b>Input</b>	
Voltage supply	21.6...26.4 V DC
Input current	0.5...2.5 A DC
Backup power supply	21.6...26.4 V DC
Trigger level for the power supply	Fault < 21 V DC
<b>Output</b>	
Output current	max. 4 A, (Supply of e.g. 110 devices of ACT20M-CI-2CO-S on one CH20M BUS)
Output power	96 W
Supply voltage (output)	24 V DC
<b>Output, status relay in safe zone</b>	
Max. switching voltage, AC / Max. switching voltage, DC	250 V /
Continuous current	2 A
AC power, max.	500 VA / 60 W
<b>General data</b>	
Degree of efficiency	0,976
Ambient temperature	-20...+60 °C
Power consumption	< 2 W
Protection degree	IP20
Weight	140
Humidity	95 %, no condensation
Approvals	cULus; DETNORVER; DNVGL; EAC; FMEX; IECEXKEM; KEMAATEX

<b>Dimensions</b>	
Clamping range (nominal / min. / max.)	mm <sup>2</sup>
Length x width x height	mm
<b>Note</b>	

<b>Screw connection</b>		<b>PUSH IN</b>
2.5 / 0.5 / 2.5		
22.5 / 117.2		22.5 / 117.2
<b>Note</b>		

<b>Screw connection</b>	
2.5 / 0.5 / 2.5	
6.1 / 112.5	
<b>Note</b>	

**Ordering data**

	Screw connection
	PUSH IN connection
<b>Note</b>	

Type	Qty.	Order No.
ACT20-FEED-IN-PRO-S	1	8965500000
ACT20-FEED-IN-PRO-P	1	2456870000

Type	Qty.	Order No.
ACT20-FEED-IN-BASIC-S	1	1282490000

**Accessories**

<b>Note</b>
-------------

DIN mounting rail, see Accessories
------------------------------------

DIN mounting rail, see Accessories
------------------------------------

ACT20X/ACT20C/ACT20P

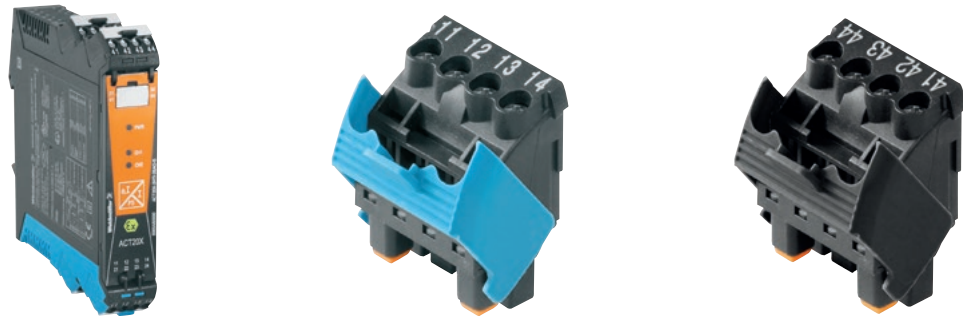

Connection terminals

Colour of housing	Release lever colour	Connection number	Printing	Type	Order No.			
black	blue	65/66/67/68	white	BHZ 5.00/04/90LH BK/BL PRT 65	1086480000			
		55/56/57/58	white	BHZ 5.00/04/90LH BK/BL PRT 55	1086470000			
		45/46/47/48	white	BHZ 5.00/04/90LH BK/BL PRT 45	1086460000			
		61/62/63/64	white	BHZ 5.00/04/90LH BK/BL PRT 61	1086420000			
		51/52/53/54	white	BHZ 5.00/04/90LH BK/BL PRT 51	1086410000			
		41/42/43/44	white	BHZ 5.00/04/90LH BK/BL PRT 41	1086400000			
	black	black	65/66/67/68	white	BHZ 5.00/04/90LH BK/BK PRT 65	1086240000		
			55/56/57/58	white	BHZ 5.00/04/90LH BK/BK PRT 55	1086230000		
			45/46/47/48	white	BHZ 5.00/04/90LH BK/BK PRT 45	1086220000		
			61/62/63/64	white	BHZ 5.00/04/90LH BK/BK PRT 61	1086180000		
			51/52/53/54	white	BHZ 5.00/04/90LH BK/BK PRT 51	1086170000		
			41/42/43/44	white	BHZ 5.00/04/90LH BK/BK PRT 41	1086160000		
			black	blue	35/36/37/38	white	BHZ 5.00/04/90LH BK/BL PRT 35	1086450000
					25/26/27/28	white	BHZ 5.00/04/90LH BK/BL PRT 25	1086440000
15/16/17/18	white	BHZ 5.00/04/90LH BK/BL PRT 15			1086430000			
31/32/33/34	white	BHZ 5.00/04/90LH BK/BL PRT 31			1086390000			
21/22/23/24	white	BHZ 5.00/04/90LH BK/BL PRT 21			1086380000			
11/12/13/14	white	BHZ 5.00/04/90LH BK/BL PRT 11			1086370000			
11/12	white	BHZ 5.00/02/90LH BK/BL PRT 11			1086250000			
black	black	21/22		white	BHZ 5.00/02/90LH BK/BL PRT 21	1086260000		
		35/36/37/38		white	BHZ 5.00/04/90LH BK/BK PRT 35	1086210000		
		25/26/27/28		white	BHZ 5.00/04/90LH BK/BK PRT 25	1086200000		
		15/16/17/18		white	BHZ 5.00/04/90LH BK/BK PRT 15	1086190000		
		31/32/33/34		white	BHZ 5.00/04/90LH BK/BK PRT 31	1086150000		
		21/22/23/24		white	BHZ 5.00/04/90LH BK/BK PRT 21	1086140000		
		11/12/13/14		white	BHZ 5.00/04/90LH BK/BK PRT 11	1086130000		
41/42	white	BHZ 5.00/02/90LH BK/BK PRT 41	1086040000					



Cold-junction compensation terminals (optional for the ACT20X temperature modules)

1-channel	Release lever colour	Connection number	Printing	Order No.
black	blue	11/12/13/14	white	1160640000
2-channel				
black	blue	11/12/13/14	white	1160650000



Markers

Type	Version	Dimensions	Qty.	Order No.
ESG 66/20BHZ500/04	Individual markers	6.6 x 20 mm	200	1082540000
ESG 8/13,5/43,3 SAI AV	MultiCard (24 individual markers per MultiCard)	8 x 13.5 mm	5	1912130000

**ACT20M**



**Ordering data markers**

ACT20M marker
<b>Note</b>

Type	Qty.	Order No.
MS 5/7,5 MC NEUTRAL	320	<b>1877680000</b>
The ACT20M voltage supply is cross-connected using the CH20M rail bus. Details are available on pages C.14 and G.6		

**ACT20P**



**Ordering data markers**

ACT20P/X/C marker
<b>Note</b>

Type	Order No.
ESG 8/13.5/43.3 SAI AU	<b>1912130000</b>



Accessories MCZ



Ordering data end plates

Type	Qty.	Order No.
End plate		

Type	Qty.	Order No.
AP MCZ 1.5	50	8389030000



Ordering data cross-connection

Type	No. of poles
Plug-in cross-connection, yellow	2
Plug-in cross-connection, yellow	3
Plug-in cross-connection, yellow	4
Plug-in cross-connection, yellow	10

Type	Qty.	Order No.
ZQV 4N / 2 GE	20	1758250000
ZQV 4N / 3 GE	20	1762630000
ZQV 4N / 4 GE	20	1762620000
ZQV 4N / 10 GE	20	1758260000



Ordering data markers

Type	Qty.	Order No.
Multicolor connector marker		

Type	Qty.	Order No.
WS10/6 MC	600	1828450000

WAVE Accessories

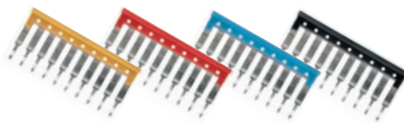

Ordering data cross-connection

Type	No. of poles
Plug-in cross-connection, black	2
Plug-in cross-connection, red	2
Plug-in cross-connection, blue	2
Plug-in cross-connection, yellow	2

Type	Qty.	Order No.
ZQV 2,5N/2 sw	60	1718080000
ZQV 2,5N/2 rt	60	1717900000
ZQV 2,5N/2 bl	60	1717990000
ZQV 2,5N/2 ge	60	1693800000



Ordering data markers

Type	Qty.	Order No.
Multicolor connector marker		
Multicolor connector marker		
Multicolor connector marker		

Type	Qty.	Order No.
WS 10/5 MC NE WS	920	1635000000
WS15/5 MC	480	1609880000
WS10/6 MC	600	1828450000



**Screw-connect connector strip for the WAVESERIES****3-pole**

Type	Printing	Order No.
BLZ 5.08/3 SN OR BEDR.	1, 2, 3	2242030000
BLZ 5.08/3 SN OR BEDR.	4, 5, 6	2242050000
BLZ 5.08/3 SN OR BEDR.	7, 8, 9	2242060000
BLZ 5.08/3 SN OR BEDR.	10, 11, 12	2242070000

**2-pole**

Type	Printing	Order No.
BLZ 5.08/02/180 SN OR BX	without labelling	1526460000
BLZ 5.08/02/180 SN OR PRT	1, 2	2246070000
BLZ 5.08/02/180 SN OR PRT	3, 4	2246080000
BLZ 5.08/02/180 SN OR PRT	5, 6	2246090000
BLZ 5.08/02/180 SN OR PRT	7, 8	2246100000

# Portacal 1000EU

## Calibration device for current and voltage signals

The Portacal 1000EU is a calibration device which is controlled by a microprocessor. It is used for current and voltage signals. It has three output modes for simulating signals:

- **Voltage source:** for the simulation of externally-supplied voltage transmitters
- **Current source:** for the simulation of externally-supplied current sensors
- **Current sink mode:** simulates the outputs of a two-wire (loop-powered) transmitter.

Commonly used calibration functions can be invoked for each mode by pressing a button. Up to 9 storage locations per mode are available to save the individual values.

Furthermore, the Portacal 1000EU can be programmed in a way that all modes can be cycled automatically. The corresponding values are controlled continually for a pre-defined time by means of a value storage. The following values can be checked and parameterised:

- Voltage outputs
- Current outputs
- Two-wire transmitter outputs

The Portacal 1000EU provides the necessary voltage supply for the sensor in order to check a two-wire transmitter.

### Technical features:

- Complete diagnosis tool for current and voltage supply
- Measuring and simulating of voltage and current signals
- Simulation of function of signal transmitter, which can be auxiliary-powered or process-powered (two-wire type)
- Continually adjustable step and ramping function
- Accuracy < 0.05 % in all signal domains
- Light and portable
- Supply via NiMH rechargeable battery or comparable battery
- Signal tone at the press of a button

## Typical application of Portacal 1000EU

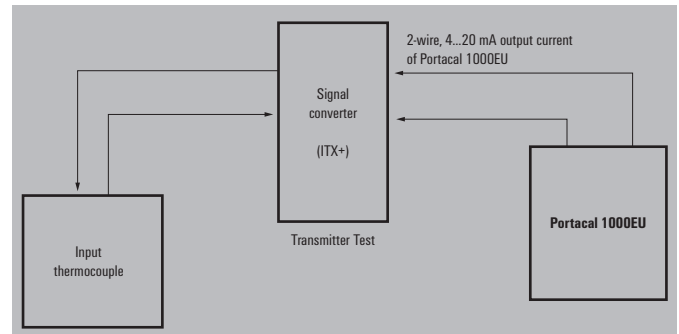

## PORTACAL 1000EU

## Instrument Calibrator

## Technical data

<b>Output voltage mode</b>	
Output voltage	0...13 V
Resolution	0.01 V
Load current	0...10 mA
Accuracy	±5 mV
Residual ripple	< 1 mV
Internal storage	Nine user-defined voltages
<b>Output current mode</b>	
Output current	0...26 mA
Resolution	0.01 mA
Load resistance	600 Ω @ 20 mA (power source) 100 Ω (current sink)
max. input voltage current sink	9...45 V DC
Accuracy	±5 μA
Residual ripple	< 1 μA
Internal storage	Nine user-defined currents
<b>Input voltage mode</b>	
Input voltage	0...13 V
Input resistance	200 kΩ
Accuracy	±5 μA or ±1 digital step
<b>Input current mode</b>	
Input current	0...26 mA
Input resistance	47 Ω
Accuracy	±5 μA or ±1 digital step
<b>Loop powered mode</b>	
Type	Mode for loop-powered signal-converters
Input current	0...26 mA
Feed voltage	16 V ±10 %
Accuracy	±5 μA or ±1 digital step
<b>Auto step/ramp mode</b>	
Step	Output of each value within a certain time period
Ramp	Output via a programmed ramp function
Number of recorded values	2...9
Time interval	10...4200 s
<b>Display</b>	
Type	Four-digit display with LCD, 12 mm
Status indicator	Five LEDs for output mode, signal amplification and reduction
Display value	Percent or real-value displayed
<b>Keyboard</b>	
Type	16 buttons with acoustic signal
Calibration	Adjustable fixed values: 0, 2, 4, 8, 10, 12, 16, 18, 20 mA 0, 1, 2, 4, 5, 6, 8, 9, 10 V Nine freely-definable values 1 / 0.1 / 0.01 mA or V
Memory	
Decimals	
<b>General data</b>	
Supply voltage	Battery, 4x type 'AA'
Temperature coefficient	< 0.01 % / °C at 100 %
Ambient temperature (operational)/storage temperature	0 °C...60 °C / -25 °C...+70 °C
Type of connection	Sockets
EMC standard	DIN EN 61326
Approvals	CE, cULus
<b>Dimensions</b>	
Length x width x height	44 x 100 x 180 mm
<b>Note</b>	

## Ordering data

Type	Qty.	Order No.
PORTACAL 1000EU	1	1439640000
2 x 1 m test cable sw/rt with banana plug/terminal		

## Accessories

<b>Note</b>	
-------------	--

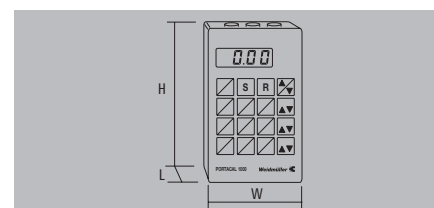

# Portacal 275

## Hand-held signal source and loop calibrator

The Portacal 275 is a precise hand-held signal source for current and voltage signals. It can be used in four modes which allows the calibration of standard current/voltage transmitters.

The operating mode "voltage source" simulates auxiliary-powered transmitters with proportional voltage outputs. The mode "current source" allows emulation of transmitters with proportional current outputs. The "mv source" mode simulates a variety of other analogue signals from many different applications. The "current sink" mode simulates the outputs of a two-wire (loop powered) transmitter.

The Portacal 275 is equipped with a scalable potentiometer (0 to 100 %) that can be adjusted in steps to an accuracy of 0.1 %. Together with the output-range switch, the potentiometer allows for a quick and precise adjustment of the signal value. A typical accuracy of  $\pm 0.25$  % is possible. An integrated test point, for connecting external measurement devices, allows for a higher accuracy of  $\pm 0.1$  %.

### Technical features:

- Light and portable device
- Simulates loop-powered transmitter operation
- LED for indication of source/sink operating mode
- Current ranges: 0 to 20 mA / 4 to 20 mA / Voltage ranges: 0 to 5 V / 1 to 5 V / 0 to 200 mV
- 0.1 % accurate current source
- Test points for current output monitoring
- Switch select 0 %, 100 % or variable output
- Signal outputs can be adjusted with spindle potentiometer for high accuracy
- Powered from two 9 V block batteries

**Portacal 275**

Calibration device for current and voltage signals

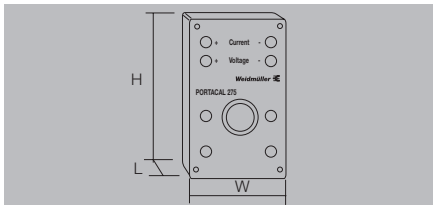

**Portacal 275**



**Technical data**

<b>Output of voltage mode</b>	
Output voltage	0...5 V / 1...5 V; 0...200 mV / 40...200 mV
Resolution	0.01 V
Output resistance	250 Ω @ V / 10 Ω @ mV
Accuracy	< 0.2% (0% and 100%)
<b>Output current mode</b>	
Output current	0 (4)...20 mA
Resolution	0.01 mA
Last resistor, max.	700 Ω (current source) ( $V_{out} - 4$ ) / 0.02 Ω (current sink)
Output voltage, max. @ current sink	4...45 V DC
Accuracy	< 0.1% (0% and 100%)
Residual ripple	< 1 μA
<b>Settings</b>	
Range of adjustment	0 (4)...20 mA / 0...200 mA (current source), 0...5 V (voltage source) or as current sink selectable with toggle switch
Output, variable	0...100 % with precision potentiometer
Output, fixed	0 or 100 % with toggle switch
<b>General data</b>	
Temperature coefficient	typ. 40 ppm @ °C
Accuracy	0.25 % of signal range
Voltage supply	Batteries, 2 x 9-V blocks 6...22 mA (current source) 2 mA (current sink)
Ambient temperature	0 °C...60 °C
Storage temperature	-25 °C...70 °C
Type of connection	Socket connector
EMC standards	DIN EN 61326
Approvals	CE, cULus

<b>Dimensions</b>	
Length x width x height	mm
	31 / 62 / 112

<b>Note</b>	Including two one-metre-long test leads sw/rt with banana plug/terminal and one bridge lead
-------------	---

**Ordering data**

Type	Qty.	Order No.
P275	1	7940010202

<b>Note</b>	
-------------	--

**Accessories**

<b>Note</b>	
-------------	--

**Wiring diagram**

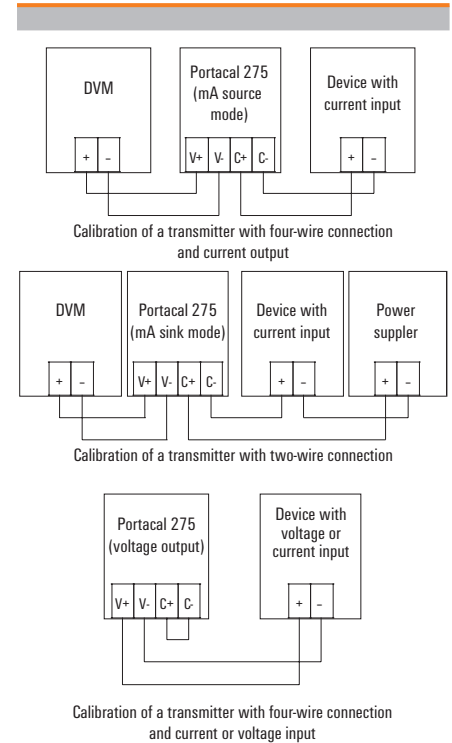



# Service and support

<b>Service and support</b>	Our expertise for your requirements	V.2
	Engineering support and customised assembly	V.3
	Personal Support	V.4

## Our expertise for your requirements

### Service connects – worldwide



Automation technology functions are becoming more complex in a globally-oriented world facing ambitious targets in terms of energy efficiency and smart production. We are your equal partners for the best connections in Industrial Connectivity.

Our personal support can answer any questions reliably and expertly. Our online services are available 365 day a year around the clock to provide answers to your questions on our products – from user documentation through software to planning tools.

In short: Weidmüller's global service combines our expertise with your requirements.



**Your way to our service**  
[www.weidmueller.com/service](http://www.weidmueller.com/service)



## Engineering support and customised assembly

Automation engineering and connectivity consulting belongs to our services as well as assembly of engineered products. We also support the process from the idea to the product with our Weidmüller Configurator and the Configure-to-Order process.



### Consulting and engineering

The challenge for you is reducing costs and increasing efficiency. This requires intelligent, individual solutions. Whether it is modified products, pre-fitted mounting rails or complete small cabinets – our application centres provide a highly qualified custom-made engineering and production service.



### Connectivity Consulting

Alongside our product offering, we support you with our range of services through all the phases of machine construction. The result of this collaboration is a reduction of up to 30% in cycle times, up to 20% more space in the control cabinet and significant fault reduction. Our experienced Connectivity Consulting team delivers a practical impetus rather than just abstract theories.



### Fitted mounting rails

Your processes in panel building have to be fast, flexible and productive. This is the only way you can cut your costs and increase efficiency. Depending on the application in question, you will have different requirements with respect to the engineering service, delivery speed and flexibility to be provided.



### Processed and assembled enclosures

To compete internationally, your plants need to satisfy high standards of safety, quality and performance. The smart combination of consultation, application expertise and industry know-how is our key to finding a custom-fit solution for your application. Reduce costs and increase efficiency

## Personal support

Exactly the right help and information on our solutions and products



If our products are used in your automation technology applications, you need the best possible individual support, from planning through installation to operation. For every stage of your application, we can offer the right tools and information for our products and solutions. Up-to-date, uncomplicated, comprehensive and around the clock via our service portal at [www.weidmueller.com/support](http://www.weidmueller.com/support).

V



**Your way to your local personal support**  
[www.weidmueller.com/support](http://www.weidmueller.com/support)



### Technical downloads

All information, such as technical data, manuals, certificates and much more for the appropriate use of our products and solutions in your application

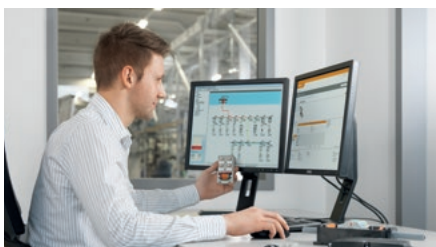

### Engineering data

For the quick integration of our products into your design, there are a lot of digital product data for engineering systems like EPLAN, Zuken E3.series, WSCAD and many others available for download.



### Product software

Our software makes using and configuration of our products easier for you when it comes to operation, configuration and monitoring



### Approvals, certificates & declaration of conformity

We supply product- or company-related approvals and certificates for your documentation



### Security advisory board

Our Product Security Incident Response Team (PSIRT) continuously informs you about possible security-related vulnerabilities of our products



# Technical appendix/Glossary

<b>Technical appendix/Glossary</b>	Dimensioned drawings	W.2
	Introduction	W.4
	Technical data	W.6
	FDT/DTM - The standard solution for device configuration	W.10
	EX basics	W.12
	ATEX	W.18
	Electrical data	W.20
	General technical information	W.22
	Glossary	W.23

Dimensioned drawings

ACT20X/ACT20C/ACT20P

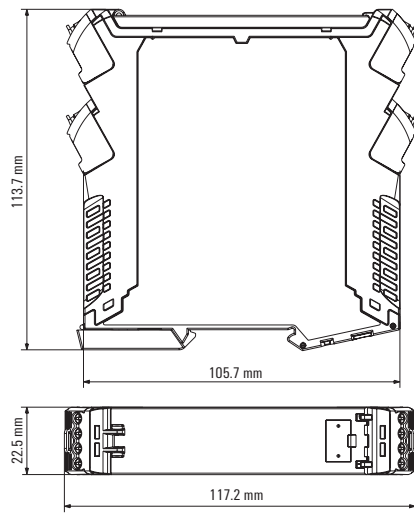

ACT20X HUI-SAO-LP-S

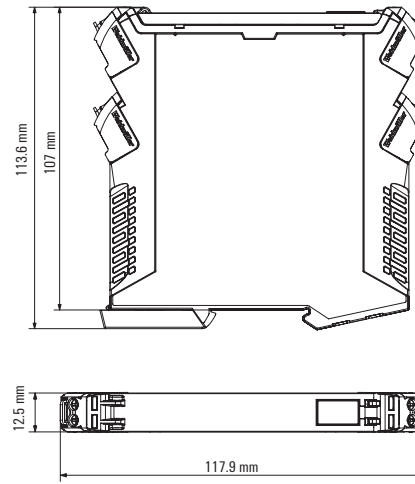

ACT20M – Dimensioned drawings

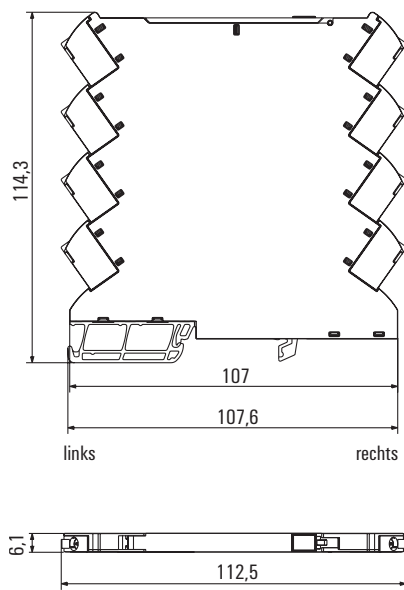

MCZ

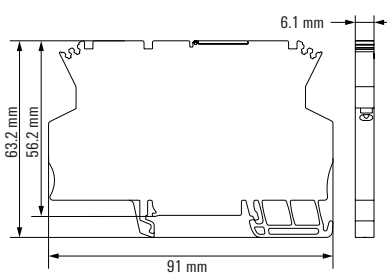

W

**WAVEBOX S 22,5**

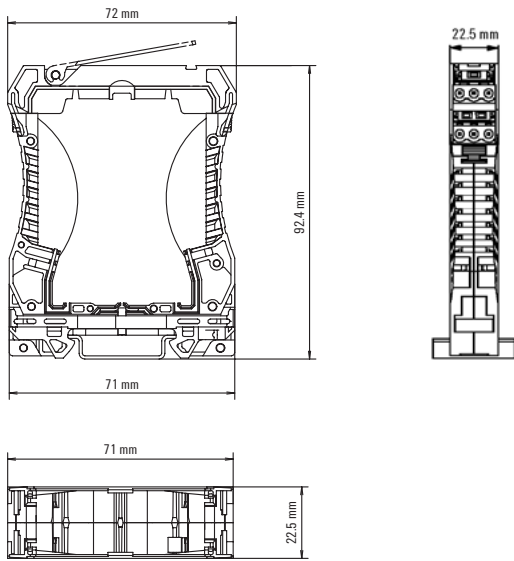

**WAVEBOX L 22,5**

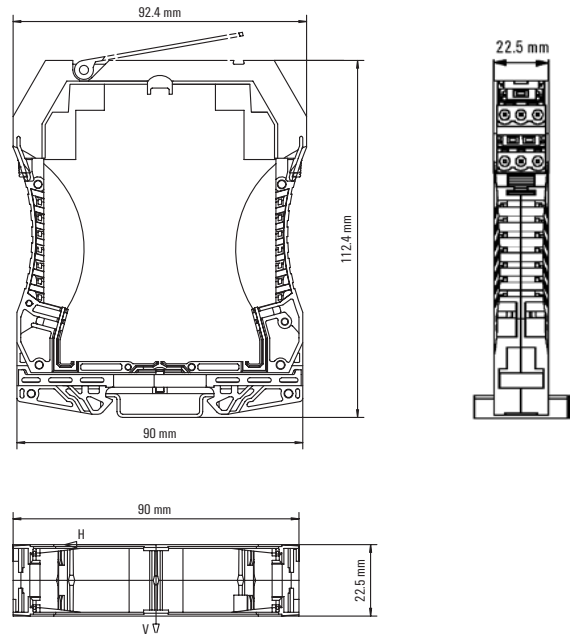

**WAVEBOX 12,5**

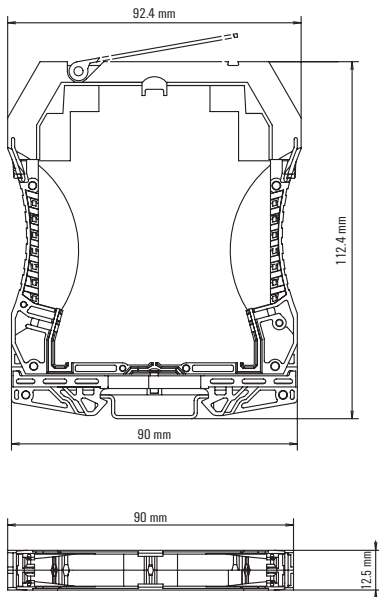

**WAVEBOX 17,5**

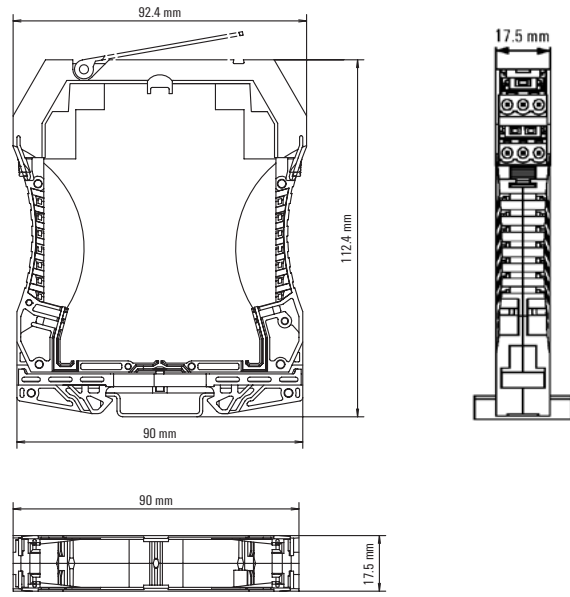

## Different types of analogue signalling

The working environment can be measured in many different forms, e.g. in terms of temperature, humidity or air pressure. The values of these physical variables change constantly. Components that monitor the status and changes of a given environment and provide alerts of any changes must be able to continuously display the changes taking place.

In industrial and process automation, the outputs received from field sensors, switches and transmitters provides measurement and status data which becomes the analogue and digital inputs (AI and DI) for the control system. Similarly, control signals are passed from the control system to field control equipment such as analog and digital valves and actuators.

If automation processes are expected to reach certain statuses or keep them constant, then analogue signal conditioning is required. It is also important in areas where this has already been part of long established practice, e. g. in process engineering or the chemicals industry.

In process engineering, standardised electrical signals are normally used. Currents of 0 ... 20 mA, 4 ... 20 mA or voltages of 0 ... 10 V have become established as the output variables for sensors recording various different physical parameters.

Weidmüller takes account of the growing preference for automation – including and the resulting need for analogue signal conditioning – and offers a wide range of products tailor-made to the requirements involved in handling sensor signals. Units for the common signals (0 ... 20 mA, 4 ... 20 mA, 0 ... 10 V) generate an output signal as a proportional value of the variable input signal. "Protective separation", e.g. of the sensor circuit from the evaluation circuit, is also taken into account. "Protective separation" prevents mutual interference among several sensor circuits, e.g. as in the case of earth loops in interlinked measuring circuits.

The wide range of Weidmüller products completely covers the functions involved in signal conversion, signal separation and signal monitoring. The products can thus handle nearly all applications in industrial measuring technology, and safeguard elementary functions between field signals and further processing systems. The mechanical properties of the products are built up around a consistent concept.

Signal converters can be used with other Weidmüller products and combined with each other. They are designed to entail a minimum wiring workload and maintenance in both electrical and mechanical terms.

The product range contains the following functions:

- DC/DC converters
- Current converters
- Voltage converters
- Temperature converters for resistance thermometers (RTDs) and thermocouples
- Frequency converters
- Potentiometer transducers
- AC transducers
- Bridge transducers (strain gauges)
- Threshold monitoring modules
- AD/DA converters

The products are available as pure signal converters, or with 2-port or 3-port isolation and a choice of passive or output loop powered or auxiliary powered, depending on the application requirements.





**2-way isolation** separates the signals from each other electrically and decouples the measuring circuits. Potential differences – caused by long line lengths and common reference points – are eliminated. Furthermore, the electrical separation protects against irreparable damage caused by overvoltages as well as inductive and capacitive interference.

**3-way isolation** decouples the supply voltage from the input and output circuits as well and enables the function to operate with just one operating voltage.

The **passive separator** offers an extra, decisive advantage – it requires no additional voltage supply. The power supply to the module is achieved via the input or output circuit and is transmitted to the input/output. This current loop feed is characterised by a very low consumption.

A number of products are available for temperature measurements. For example, **PT100** signals in 2-, 3- and 4-wire systems are converted into standard 0...20 mA, 4...20 mA and 0...10 V signals.

The modules for connecting conventional **thermoelements** are fitted with cold trap compensation as standard. Furthermore, they amplify and linearise the voltage signal provided by the thermocouple. This guarantees accurate analogue signal conditioning while eliminating sources of interference or error.

**Frequency** converters convert frequencies into standard analogue signals. Downstream controls can therefore directly process pulse strings for measuring rpm or speed.

**AD or DA converters** are required for bringing together the analogue signal forms mapping the local conditions and the digital processing in the process monitoring system. Weidmüller can supply such components for the customary 0...20 mA, 4...20 mA and 0...10 V input and output signals. 8-bit processors are available on the digital side.

**Current-monitoring** modules can be used to control DC and AC currents up to 60 amps. A switching operation is triggered when the set current values are not met or exceeded. Components with analogue outputs monitor the current load continuously via downstream controls.

**Voltage monitoring modules** can be used to monitor AC and DC voltages. Adjustable switching thresholds can be used to reliably detect and notify in the event of fluctuations caused by switching operations or mains overloads.

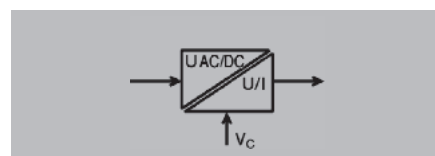
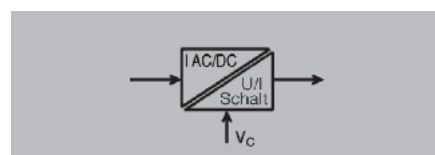
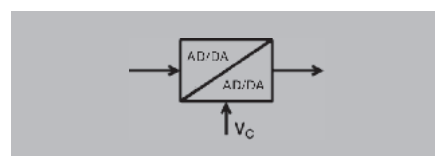
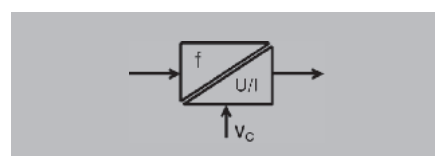
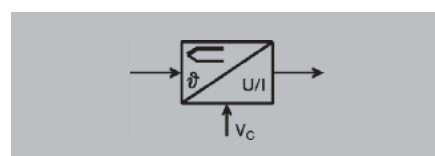
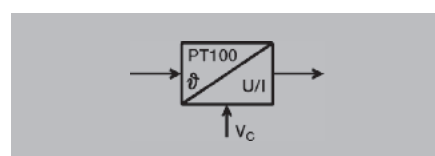
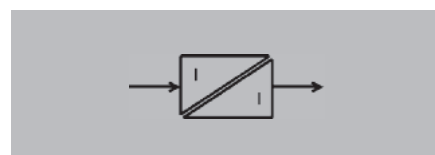
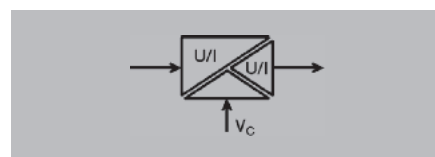
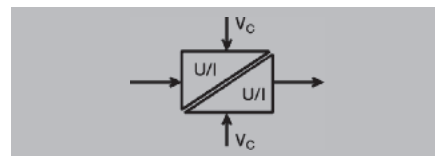

# Technical data



## Common Mode Noise Elimination

- Generally, signals emitted by sensors have low levels and are thus susceptible to capacitive and inductive interference, such as those generated by motors, frequency changers and other change processes. This noise contents the measuring value and frequently destroys expensive analog I/O cards in the control electronics. Through the utilisation of analogue signal isolators this interference, which usually actions both signal lines in common mode (push push), is effectively eliminated through the zero potential input.

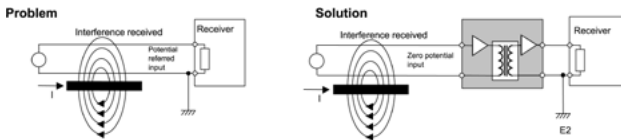

## Active Isolator / Passive Isolator

- Active isolators draw their power supply from a separate supply terminal to ensure that they can operate perfectly. Depending upon the applications the input, output and additionally the power supply are isolated from each other. Only one supply is required for 3-port isolation. However, it is isolated from the input and output circuits. Thus even in the event of a short circuit, surge voltage or reverse polarity, the downstream control electronics cannot be damaged. Isolating the signals between the input and output can be conducted either optically or by transformer barrier depending upon the transfer rate. Active isolators are non interacting, i.e. a change in the load does not exert any influence on an input circuit.
- Passive isolators generate the current required for the supply from the measuring signal. The current required internally is so small that transfer problems do not occur here.
- The feed can be effected from either the input or the output side. Isolation is by transformer barrier. The advan-

tages are: cessation of network influences, outstanding accuracy, low signal delay and low potential requirement. Passive isolators are not interacting; a change in load in the output circuit will influence the input circuit.

## Ground Loops

- The voltage supply's secondary side is earthed for the purpose of setting up fast and secure ground loop monitoring. If an analogue signal is fed in from a separate voltage supply or if the sensing device itself is earthed, then transient currents will flow between the ground potentials across the interconnected ground connectors, which in turn corrupts the measuring signal. Analogue signal isolating amplifiers prevent this form of measuring signal corruption and influence.

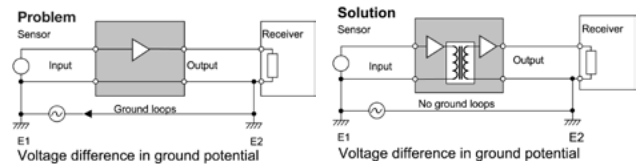

## 2-port Isolation

- The simplest form of analogue signal isolator is that of 2-port isolation. It serves to isolate the input circuit from the output circuit as well as the two auxiliary voltages from each other. Depending upon the isolator design and the observed isolation data one refers here to base isolation (galvanic isolation) or safe separation. ① For current signals, 4...20 mA input current loop fed modules are available. An additional auxiliary voltage for the input circuit is not required here. ② By connecting the input and output side voltage supplies, the 2-port isolation can be converted to operate as a simple signal converter. This is of particular interest where isolation is not required for an application, but a signal conversion has to be performed.



### 3-port Isolation

- 3-port isolation is the most universal form of signal isolator
- An optical coupler or transformer isolates the input from the output circuit. Together with the clearance and creepage distances it serves to define the isolation level. For example, the input signal is converted by means of pulse-width modulation into a frequency signal and demodulated again on the output side to form an analogue value. An amplifier then generates a standardised analogue signal. A galvanic isolated DC/DC converter feeds the input and output circuit with a potential free supply voltage. It also determines the isolation level through its data, air and creepage distances. In the case of these three isolation paths (input/output, input/auxiliary voltage, output/auxiliary voltage) one refers to 3-port isolation.

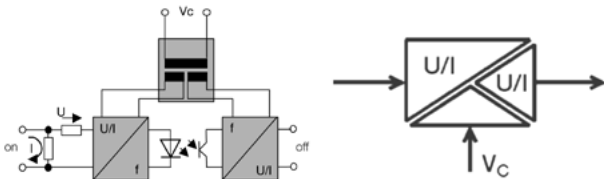

### Temperature Signal Measuring Method

- Measurement using resistors (RTD)  
When measuring with temperature-dependent resistors a current of approx. 1.5 mA is passed through the resistor from a constant current source in the signal converter.

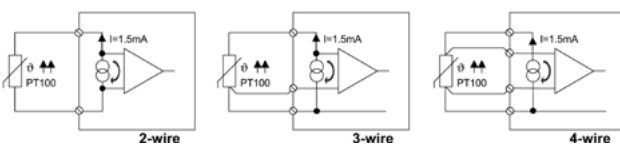

An operational amplifier is used to measure the potential drop at the resistor (2-wire circuit).

In order to take account of lead length, the voltage drop is measured at the return conductor and calculated with double the value (3-wire circuit). This simulates the wire resistances from the feed and return lines.

Accurate measurements are achieved by separately measuring the voltage drop at the feed and return lines (4-wire circuit). The values for the supply lines are calculated against the measured value.

### Temperature Signal Measuring Method

- Measurements using thermocouples  
When conducting measurements using thermocouples the voltage that is generated when two differently alloyed metals come into contact with each other is measured. A differential amplifier is then used to recondition the signal. The easiest (and the most cost-effective) method of subsequent processing is conducted by means of an amplifier circuit, which converts these signals into standard signals. High-end components process the measuring signal using a microprocessor, which simultaneously reconditions the signal (filtering, linearisation)

### Cold Junction Compensation For Thermocouples

- Recording temperatures by using thermocouples encounters the problem of a thermal voltage forming at the clamping terminals on the signal converter on account of the different materials in the conductors and bus bar. This voltage then counteracts the thermal element's voltage.

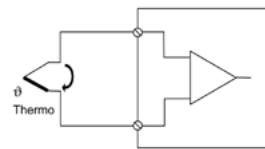

In order to compensate for the error to the measured value which arises here, the temperature is measured at the clamping terminal. The microprocessor in the signal converter reads the value measured there and calculates it against the measured value. This procedure is known as cold junction compensation.

$$\frac{\text{Voltage at the measuring point } (V_{\text{meas}}) + \text{Voltage at the terminal } (V_{\text{terminal}})}{\text{Voltage at the thermocouple } (V_{\text{thermo}})} \Rightarrow \text{Temperature at the thermocouple } (T_{\text{thermo}})$$

### Linearisation

- Temperature-dependent components do not normally have linear characteristic curves. To ensure that further processing can take place with the necessary accuracy, these characteristic curves have to be linearised to some extent. The graph showing measurements of thermocouples, in particular, reveals significant deviations at some points from the "ideal graph". As a consequence, the signal which has been measured is worked up by microprocessor.

Technical data

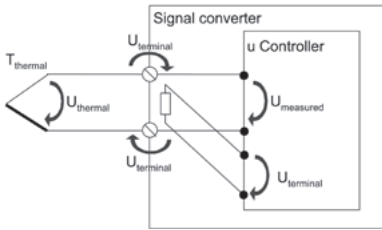

The microprocessor compares the value measured with the characteristic curve for the thermocouple in its memory and calculates the corresponding value on the "ideal characteristic curve". At the output, it supplies the latter to an amplifier, which produces the analogue value in linear form. The output stage converts this into a standardised value or into a switching output with a switching threshold.

The linearisation of PT100-elements can be undertaken via simple amplifier stages. The first stage corrects the peak value of the graph of the measurements. The deviation at the end of the graph resulting from this is corrected by a second stage. The under- and overshooting generated in this way is very slight and is covered by the tolerance for the module.

**Current Measurement Using A Measuring Transformer**

- Transformer principle: Each conductor through which current flows is surrounded by a magnetic field H, the intensity of which is proportional to the current. The field, which is bundled in a magnetic core, generates a magnetic flux B, through which suitable sensors are used to measure current.

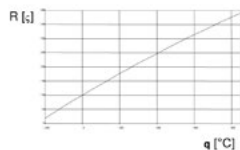
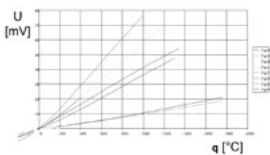

Converters with transformer-type couplings are used to establish the most cost effective measurement method for simple sinusoidal currents. The current to be measured flows directly through the measuring transformer's primary winding.

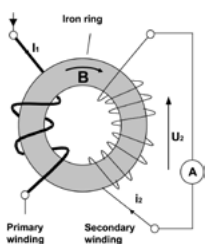

The secondary winding supplies the measuring electronics with a proportional current signal. Because of power loss this method of measuring current is limited to smaller currents up to 5 A. These converters react sensitively to peak loads and therefore have to be fused on the primary winding side.

**Measuring Current Using A Hall-type Sensor**

- Hall-type sensor principle: Hall-type sensors also measure the magnetic flux B and supply a proportional voltage at the measured output, which is then reconditioned to form a standard signal by an amplifier circuit.
- Components with Hall-type sensors are ideally suited to measuring higher currents, as any possible high residual currents from motors or peak loads cannot damage the component. Additionally, they are also ideal for measuring direct and alternating currents of various curve shapes.

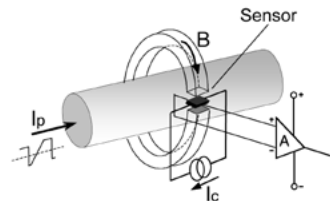

**Root Mean Square Measurement / Crest Factor**

- The root mean square value (r.m.s) of a sinusoidal shaped alternating current is the value, which in an ohmic resistor converts the same (effective) output as that of an equal sized direct current.
- Non sinusoidal shaped signals can only be measured with "True RMS" capable devices and/or further processed.
- True RMS = True root mean square
- Root mean square measurement is required where the (effective) output content of alternating voltages or currents are to be measured or evaluated.
- The crest factor indicates the ratio of the crest factor to the root mean square value.

W

### Load / Load Resistor

- The load is a load resistor on the output side of a measuring transducer or isolating amplifier. The load is usually less than 500 Ω at the current outputs. Voltage outputs are normally under a load greater than 1 KΩ.

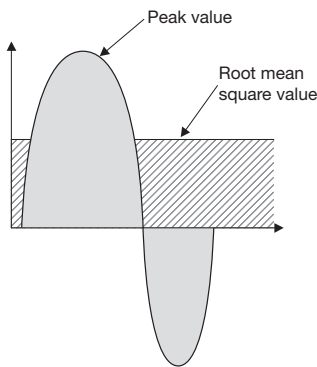

### Galvanic Isolation / Safe Separation

- Galvanic isolation is understood to mean an electrical isolation between the input and output circuit and the circuit's supply voltage. It can be set up either optically using an opto coupler or with a transformer. The isolation serves to safeguard the measuring circuit against damage and to eliminate ground loops, which could cause the measured signal to be corrupted.
- Safe separation is specified under the German DIN VDE 0106 Section 101 standard. This fundamental safety standard is intended to safeguard persons against hazardous body currents and describes the basic requirements for safe separation in electrical operating equipment. Thus, for instance, the voltage supply of 50 V AC/ 75 V DC as under 50178 may not be exceeded. If this voltage is exceeded a reinforced or double insulated and thus an increase in the clearance and creepage distances is stipulated.

### Cut-off Frequency

- Cut-off frequencies indicate the dynamic transfer characteristic of an isolation amplifier.
- The given frequency is the (-3dB-) limit, at which a distinct change occurs to the signal.
- An increased cut-off frequency leads to a transmission of higher-frequency alternating components, which corrupts the required signal.

### Hysteresis

- Hysteresis indicates the percentage difference between the input and output points of a switching contact. It should not be lower than a given minimum value, as otherwise a specified chase can no longer be implemented.

### Broken-wire Detection

- When measuring transformers with broken wire detection the input signal is monitored permanently. In the event of a fault (broken wire) the output signal exceeds its rated range. The downstream control circuit can then analyse the fault case.

### Response Time

- Response time refers to the change in output signal for an input signal jump (10 ... 90 %). It is directly related to the cut-off frequency (inversely proportional).

### Accuracy / Temperature Coefficient

- Accuracy describes the capability of a measuring device to deliver a measured value as accurately as possible. It relates to the end value and is given for ambient temperature (23 °C). Example:  
An RTD is given with an accuracy of 1 %. The measuring range is set to 0 – 200 °C. The expected effective error of:  $200 \cdot 1 \% = \pm 2K$  applies across the entire measurement range.
- Temperature coefficient describes the deviations in accuracy of the measuring devices dependent on the ambient temperature. It is given as a % or in parts per million / Kelvin (ppm /K).  
Example:  
An RTD with an accuracy of 1 % and a measuring range of 0 – 200 °C has a temperature coefficient of 250 ppm / K. If the device is operated at +40 °C, it will then contribute the following to an expected absolute error:  $(([40 \text{ °C} - 23 \text{ °C}] \cdot 250 \text{ ppm/K}) + 1 \%) \cdot 200K = \pm 2,85K$  across the entire measurement range.

# FDT/DTM – The standard solution for device configuration

## Field Device Tool (FDT)

FDT technology specifies and standardises the integration of communicating devices from different manufacturers. It makes use of a superimposed device management program. The key feature is its independence from the communication protocol and software used by the device and the host system. FDT allows access to any device from any host using any protocol.

## Device Type Manager (DTM)

Device manufacturers make available a Device Type Manager (DTM) software driver for each device or device group. The DTM specifies all device-specific information, functions and rules (such as the device structure, communication capabilities, internal dependencies and the human-machine interface (HMI)). DTMs define functions for access to device parameters, troubleshooting, configuration and operation of devices. DTMs are available which can be simple GUIs for setting device parameters or more complex applications that are capable of carrying out calculations for diagnostic or maintenance purposes.

There are several different types of DTMs:

- **Device DTM**  
This is a “normal” field device that uses communication channels to communicate with the connected physical device.
- **Communication DTM**  
This is a communications device that provides communication using communication channels. Communication channels provide access to the communications infrastructure (such as PC interface cards or modems). They are used by device DTMs or gateway DTMs for communication services.
- **Gateway DTM**  
This is a gateway device. It allows data to be exchanged between two communication channels. For example, this could be a gateway between PROFIBUS-DP and PROFIBUS-PA.

The DTM is loaded and started up within a FDT container program or “frame” application.



## FDT frame application

Frame applications can be used as a tool to configure devices, plan projects, operate consoles or administer facilities. The FDT frame application provides a PC software environment with the following functions:

- User administration
- DTM administration
- Data management
- Network configuration
- Navigation

Weidmüller offers their WI-Manager FDT frame program to the user for no cost. This certified software is compatible and works together with all certified DTMs. This screenshot shows the WI-Manager with an opened DTM for the ACT20X series.

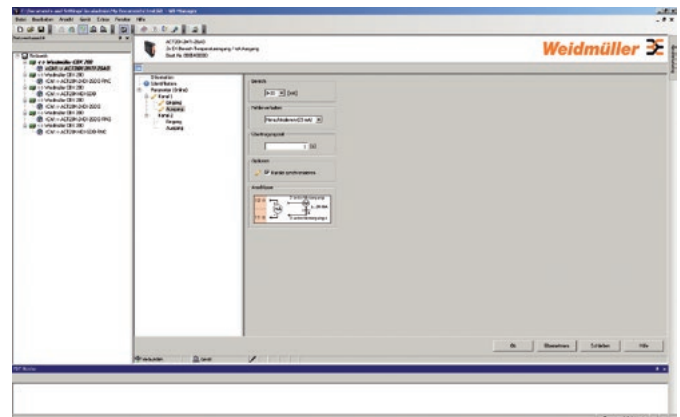

Download at [www.weidmueller.com/](http://www.weidmueller.com/)



## FDT User Group

The FDT User Group is an alliance of users and manufacturers interested in defining the specifications and moving the FDT/DTM technology forward. Weidmüller is a member of this group along with most process automation manufacturers and work towards advancing this standard further.

More details are available at <http://www.fdtgroup.org/>

# Safety in hazardous areas

When operating electrical devices within hazardous areas, you must comply with the requirements regulating their use in such zones. Explosive atmospheres may be created from mixtures of flammable gases, mists, vapours or dusts. If their concentration is high enough in the surrounding air, any source of ignition or spark could trigger an explosion. Such explosions can cause death, serious injuries and significant property damages.

There are basically two strategies for reducing the risk of explosion. Firstly, no dangerous materials should be released into the air that could create an explosive atmosphere.

Secondly, there should be no mechanism present that could create a spark.

Many explosions in the past could have been avoided if only the international regulation governing the use of equipment in hazardous areas had been observed.

## But what are the most important global regulations regarding the use of devices in hazardous areas?

In North America, the US National Electric Code (NEC) regulations (Articles 500 to 505 and the Canadian CEC (Canadian Electrical Code) Articles 18-000, -090, -100, -200 and -300 are all valid.

In Europe, both EU directives ATEX 95 (94/9/EG) and ATEX 137 (1992/92/EC) are relevant. They describe preparation (ATEX 95) and usage (ATEX 137) for facilities in potential Ex zones. Throughout the rest of the world, there is a mixture of national regulations (in Eastern Europe) and international IECEx conformity declarations (in Asia) that must be followed. In certain Asian countries, the European ATEX directives have been accepted and applied.

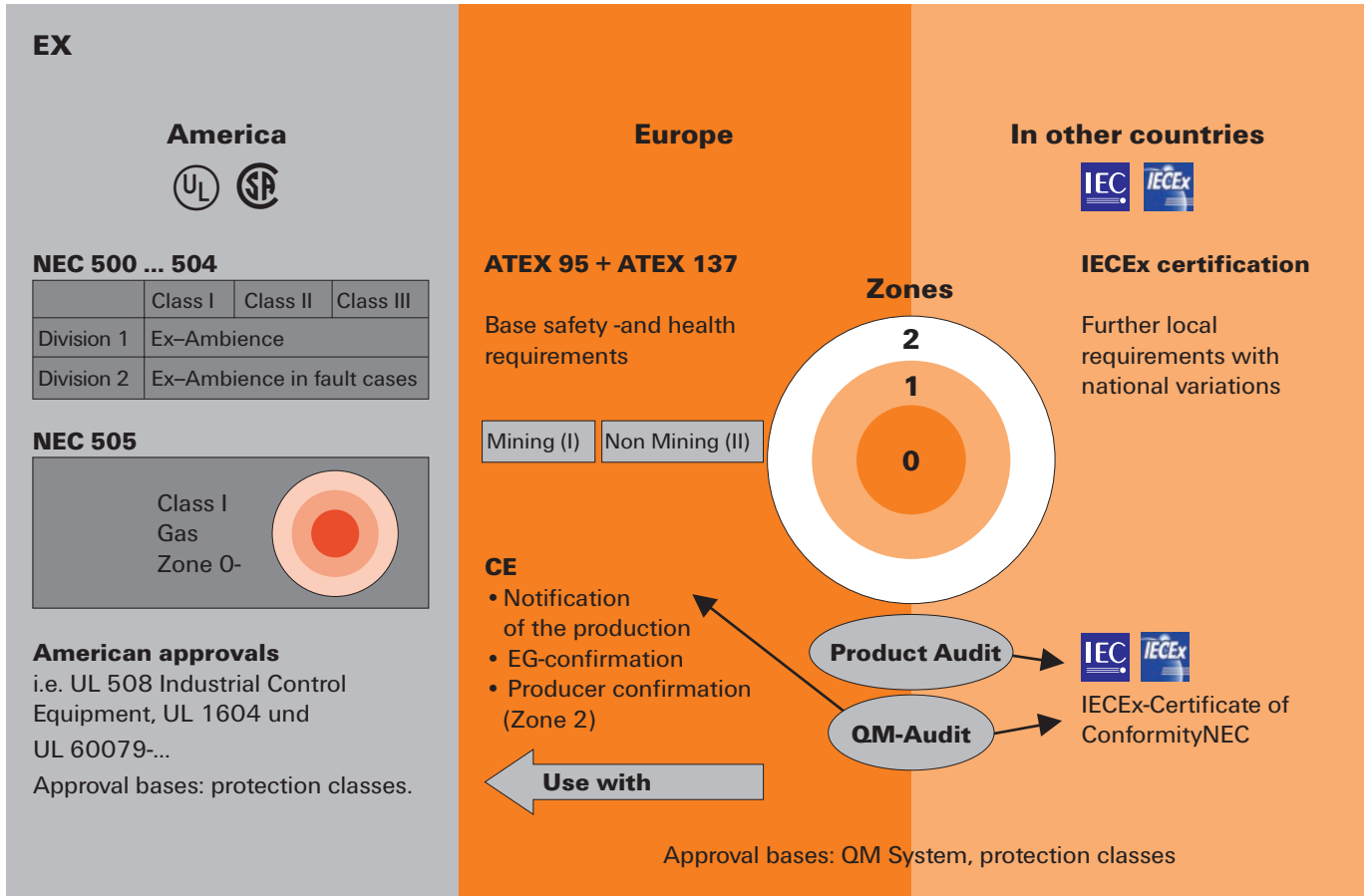

A brief overview of regulations used throughout the world and their basic content.



**The European ATEX Regulation applies to facilities and their usage in hazardous areas.**

The term "ATEX" derives from the French phrase "Atmospheres Explosive". The regulation currently includes two directives from the European Union concerning explosion protection. These are the ATEX operational directive 1999/92/EG (ATEX 137) and the ATEX product directive 94/9/EG (ATEX 95). The ATEX 137 operational directive specifies the minimum requirements for improving the protection of health and security of workers in environments at risk of explosions. The ATEX 95 product directive specifies the rules for introducing products on the market that will be used in zones where there is risk of explosion. This directive is the first to include non-electric devices within its jurisdiction.

The purpose of the directive is to protect personnel who work in hazardous areas. Appendix II of the directive contains the basic health and safety requirements. These must be followed by the manufacturer and compliance must be proven by declarations of conformity. Since June 30, 2003, all devices, components and protective systems brought to the market must be in compliance with the ATEX 95 product directive.

The ATEX 95 directive classifies devices and components for the Ex zone into two main groups:

**Group I**

=> Devices for use in mining, for underground and above-ground operations

- Coal dust
- Methane
- Harsh operating conditions

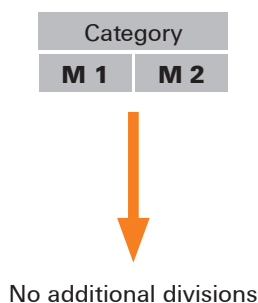

**Group II**

=> Devices for use in the other hazardous areas

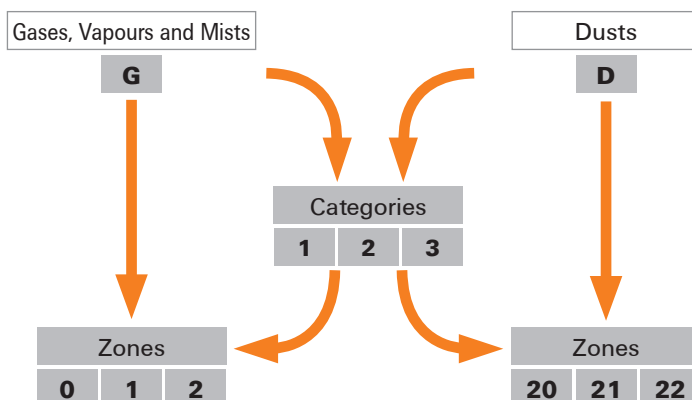

For applications in the oil, gas and chemical industries, it is particularly important to follow the Group-II "G" requirements concerning electrical or electronic devices and components.



## Safety in hazardous areas

Group II "G" divides the Ex zone into three zones with different safety requirements.

- Zone 0** This zone applies to dangerous explosive atmospheres where the risk is present often or over long time periods.  
 => > 50 % of the operational time, or more than 1.000 hours per year.
- Zone 1** This zone applies to situation where explosive atmospheres may occasionally be present during normal operations.  
 => Occasionally, less than 10 hours per year.
- Zone 2** This zone applies to situation where explosive atmospheres are normally not present or only briefly present during normal operations.  
 => Max. 30 min/year.

### Hazardous areas

	Zone 0	Zone 1	Zone 2	Safe zone
Explosion risk	Continual, long-term, often	Occasionally	Rarely	None
Spark source	None	Rarely and short-term	Occasionally	Continual, long-term, often

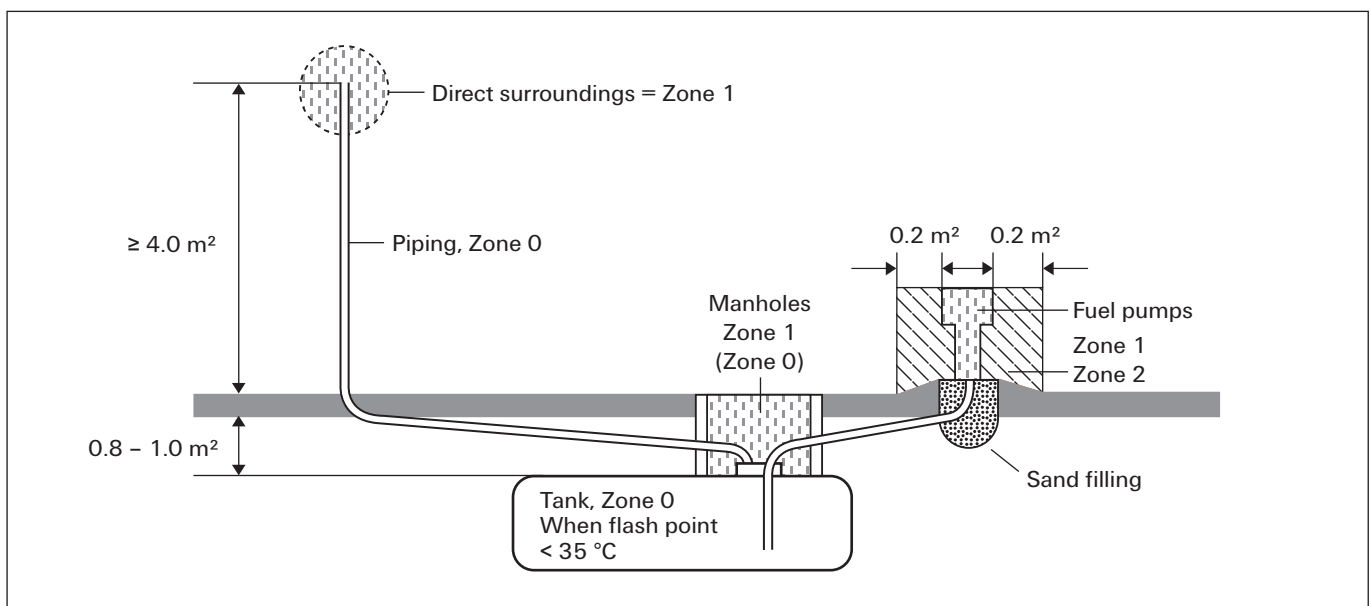

Typical division of zones at a fuelling station

### In which operations are ATEX-certified electronic devices (such as signal converters, isolation amplifier, Namur switches and switching amplifiers) used?

ATEX-certified devices are used within industrial facilities and production halls where there is the possibility that explosive gases or dusts may be released.

Transportation and production applications which require the use of such certified devices are listed below:

- Off-shore oil and gas drilling
- Tanker ships which carry oil, gas or chemicals
- Ships which carry potentially explosive materials
- Refineries and other oil or gas production plants
- Transportation and filling stations for oil and gas
- Petro-chemicals

### What are the differences between standard devices and intrinsically safe devices?

For electronic devices that are being used in Zone 0(20) or 1(21), none of the components or electrical circuitry are permitted to generate unallowable high temperatures or sparks, whether during normal operations or during malfunctions. In other words: "All of the circuits in intrinsically safe electrical devices (Ex i) are safe and are not capable of igniting explosive atmospheres".

### What is the device category?

The device Group II (hazardous areas not including underground or above-ground mining operations) is divided into device categories 1, 2 and 3. They have the following safety levels:

Surroundings	Device category	Occurrence and duration of explosive atmosphere	Ignitable materials	Safety levels Permitted errors	Groups and zones Comparison
Group II	1	Constantly occurring Long-term Regularly	Gases, vapours, mist, dust	<b>Very high safety level</b> 2 different protection classes or 2 independent errors	Group II <b>Zone 0 (gas)</b> Zone 20 (dust)
Group II	2	Occurrence probable over a limited time period	Gases, vapours, mist, dust	<b>High safety level</b> 1 protection class For which no more than one error may occur	Gruppe II <b>Zone 1 (gas)</b> Zone 21 (dust)
Group II	3	Occurrence improbable Only for short periods	Gases, vapours, mist, dust	<b>Normal I safety level</b> Required protective measures	Group II <b>Zone 2 (gas)</b> Zone 22 (dust)

# Safety in hazardous areas

## Which explosion protection categories are most commonly used?

- **Pressure-resistant encapsulation (Ex d) in compliance with EN60079-1:**

Components that are capable of triggering an explosion are enclosed in a housing that is capable of withstanding the explosion. Openings in the housing are designed to prevent the explosion from being transmitted externally.

- **Increased safety (Ex e) in compliance with EN60079-1:**

This explosion protection category is normally applied to transformers, motors, batteries, terminal blocks, electrical lines and cables. It is not suitable for the protection of electronic components and spark-generating components (such as switches, relays or surge protection). Additional measures and an increased safety level are implemented in order to prevent any sparks, electrical arcing or unallowable high temperatures which could trigger ignitions. Increased safety is made possible by housing that prevents dusts from penetrating within.

- **Explosion protection methods (Ex n):**

This explosion protection category may only be used in the hazardous areas 2/22. Here there is no danger of an explosion from the electrical equipment during normal operations or during defined malfunctions. This includes all electrical devices and components that have no spark-forming contacts and that have a water-proof or dust-proof housing. Larger creepage and clearance distances are not required as long as the maximum rated voltage of 60 V AC / 70 V DC is maintained.

- **Intrinsic safety (Ex i) in compliance with EN60079-11:**

Power supply to electrical equipment is carried out through a safety barrier which functions to limit the current and voltage so that the minimum power and temperature levels for creating an explosive mixture are not reached. Intrinsic safety for electrical and electronic devices is specified so that their circulating or stored power (even in event of malfunction) is never strong enough to trigger an explosion in an explosive atmosphere. You must also remember that not only the electrical device but also all other components connected to the circuit may be exposed to the explosive atmosphere. All switching circuits in intrinsically safe devices must be designed so that they are also intrinsically safe.

These devices are divided into the category groups <ia> and <ib> which differ in the number of occurring malfunctions.

### Category <ia>

=> Switching circuits within category <ia> electrical devices must not be able to cause a spark even if two independent malfunctions take place.

### Category <ib>

=> Switching circuits in electrical devices must not be able to cause a spark when a malfunction.

## Electrical devices for use in explosive gas, vapour and mist atmospheres – in accordance with CENELEC

Explosion protection type	Identification	Protective design
Pressure-resistant encapsulation	Ex d	Encloses the explosion and prevents fire from spreading
Increased safety	Ex e	No spark formation or hot surfaces
Method of explosion protection	Ex n	No spark formation or hot surfaces
Intrinsic safety	Ex i	Limited energy for preventing spark formation or overheated surface temperatures

## CENELEC classification of gases, dusts and the maximum permitted surface temperatures of devices and components

Gas group	Temperature classes					
	T1	T2	T3	T4	T5	T6
I	Methane	-	-	-	-	-
IIA	Ammonia	Ethyl alcohol	Benzene, Kerosene	Acetaldehyde	-	-
	Methane	Cyclohexane				
	Ethane	n-Butane				
	Propane	n-Hexane				
IIB	Lighting gases, Acrylonitrile	Ethylene, Ethylene oxide	Ethylene glycol, Hydrogen sulphide	Ethyl ether	-	-
	IIC	Hydrogen	Ethine (Acetylen)	-	-	Hydrocarbons

IEC (group II) Classification	Max. surface temperature	Comment
T1	450 °C (842 °F)	The temperature is relevant to all parts of the devices that can come into contact with potentially explosive materials.
T2	300 °C (572 °F)	
T3	200 °C (392 °F)	
T4	135 °C (275 °F)	
T5	100 °C (212 °F)	
T6	85 °C (185 °F)	
Tx	Max. surface temperature undefined	Valid for the closed tank systems used on container ships where the individual contents cannot be monitored in event of a fire. It is the responsibility of the operator to assess each temperature class.

### What labelling is considered proper?

An example of device labelling:

CE 0539		II	2	G	Ex ia	IIA	T4
↓	↓	↓	↓	↓	↓	↓	↓
Certification authority ex. DEMKO	European Commission mark for Ex devices	Device group "Surface"	Device category zone 1	Gas	Protection explosion type: intrinsically safe category <ia>	Gas group	Surface temperature: max 135 °C

# ATEX directives

Since July 1, 2003, all new facilities in hazardous areas must be certified according to ATEX Directive 94/9/EG or ATEX 95 (ATEX: ATmosphère EXplosive = explosive atmosphere). This directive is one of the “New-Approach” directives. It is valid in all European Union countries, as well as Iceland, Lichtenstein and Norway. In these countries, the directive refers to the sale and commissioning of products which have been designed particularly for high explosion risk environments (where explosive atmospheres exist due to gases, vapours, mists, or dusts). It now also covers the mining sector and purely mechanical devices.

## Class of protection

Type of protection	Code	CENELEC EN	IEC	Product category explosion protect.
General requirements	-	60079-0	60079-0	-
Oil immersion	o	60079-6	60079-6	2
Pressurised apparatus	p	60079-2	60079-2	2
Powder filling	q	60079-5	60079-5	2
Flameproof enclosure	d	60079-1	60079-1	2
Increased safety	e	60079-7	60079-7	2
Intrinsic safety	ia	60079-11	60079-11	1
Intrinsic safety	ib	60079-11	60079-11	2
Intrinsic safety	ic	60079-11	60079-11	3
Typ n (Ex n)	n	60079-15	60079-15	3
Encapsulation	m	60079-18	60079-18	2

## Classification for potentially hazardous areas

CENELEC classification IEC60079-10	Presence of potentially explosive atmosphere	Product-category	US classification NEC 500	Combustible media
Zone 0	permanent, long-term	1G	Class I, Div 1	gases, vapours
Zone 20	or frequently	1D	Class II, Div 1	dust
Zone 1	occasionally	2G	Class I, Div 1	gases, vapours
Zone 20		2D	Class II, Div 1	dust
Zone 2	rarely and	3G	Class I, Div 2	gases, vapours
Zone 22	briefly	3D	Class II, Div 2	dust

## Explosion groups

Gas (e.g.)	CENELEC	NEC 500
Propane	IIA	D
Ethylene	IIB	C
Hydrogen	IIC	B
Acetylene	IIC	A
Methane (mining)	I	mining (MSHA)

## Temperature classes

Max. surface temperatur (°C)	Temperature class CENELEC	Temperature class NEC 500-3
450	T1	T1
300	T2	T2
280	-	T2A
260	-	T2B
230	-	T2C
215	-	T2D
200	T3	T3
180	-	T3A
165	-	T3B
160	-	T3C
135	T4	T4
120	-	T4A
100	T5	T5
85	T6	T6

# Labelling for ATEX approval of a signal converter

## II 3 G Ex nAnCnL IIC T4

- II** = Device group 2: devices for use in hazardous areas (except for mines and above-ground mining facilities that are exposed to flammable dusts or methane)
- 3** = Device category 3: the danger occurs rarely or only for short periods. The requirement is for normal security, suitable for use in zone 2.
- G** = Intended for the gas zone
- Ex** = Explosion protection
- nA** = Non-sparking equipment
- nC** = Enclosed facility (suitable protection)
- nL** = Equipment with limited power
- IIC** = Explosion groups: typical gas for C is hydrogen
- T4** = Temperature class: The max. permitted surface temperature for T4 is 135 °C

**Zone 2** a zone for which, during normal operations, there is at most, only a short-term occurrence of dangerous hazardous atmospheres (mixtures of air and flammables gases, vapours or mists).

## II (1) G [Ex ia] IIC/IIB/IIA

- II** = Device group 2: devices for use in hazardous areas (except for mines and above-ground mining facilities that are exposed to flammable dusts or methane)
- (1)** = Device category (1): Equipment from category 1 can be connected to this signal converter. The signal converter must be operated in the safe zone or in zone 2 (II 3 G ...).
- G** = Intended for the gas zone.
- [Ex ia]** = Explosion protection type: protected with intrinsic safety. This signal converter, as accompanying equipment, is intended to be used for the connection of intrinsically safe circuits.
- IIC/IIB/IIA** = Explosion groups – typical gases: propane for A, Ethylene for B, and hydrogen for C.

## II (1) D [Ex iaD]

- II** = Device group 2: devices for use in hazardous areas (except for mines and above-ground mining facilities that are exposed to flammable dusts or methane)
- (1)** = Device category (1): Equipment from category 1 can be connected to this signal converter. The signal converter must be operated in the safe zone or in zone 2 (II 3 G ...).
- D** = Designed for the dust zone.
- [Ex iaD]** = Explosion protection type: protected with intrinsic safety. This signal converter, as accompanying equipment, is intended to be used for the connection of intrinsically safe circuits.



# Design of clearance and creepage distances in electrical equipment – influencing factors

## Rated impulse withstand voltage

The rated impulse withstand voltage is derived from:

- **Voltage conductor – earth**  
(the rated voltage of the network, taking into account all networks)
- **Surge category**

**Table 1: Rated impulse withstand voltages for electrical equipment**

Rated voltage of power supplies system *) in V		Rated impulse withstand voltage in kV			
Three-phase systems	Single-phase systems with neutral point	Electrical equipment at the supplies point of the installation  (Surge category IV)	Electrical equipment as part of the permanent installation  (Surge category III)	Electrical equipment to be connected to the permanent installation  (Surge category II)	Specially protected electrical equipment  (Surge category I)
	120 to 240	4.00	2.50	1.50	0.80
230/400					
277/480		6.00	4.00	2.50	1.50
400/690		8.00	6.00	4.00	2.50
1000		Values depend on the particular project of, if no values are available, the values of the preceding line apply.			

\*) to IEC 38

## Surge categories

are stipulated in accordance with the German standard DIN VDE 0110-1 (for electrical equipment fed directly from the low-voltage network).

### Surge category I

- Equipment that is intended to be connected to the permanent electrical installation of a building. Measures to limit transient surges to the specific level are taken outside the equipment, either in the permanent installation or between the permanent installation and the equipment.

### Surge category II

- Equipment to be connected to the permanent electrical installation of a building, e.g. household appliances, portable tools, etc.

### Surge category III

- Equipment that is part of the permanent electrical installation and other equipment where a higher degree of availability is expected, e.g. distribution boards, circuit-breakers, wiring systems (including cables, busbars, junction boxes, switches, power sockets) in the permanent installation, and equipment for industrial use and some other equipment, e.g. stationary motors with permanent connections to the permanent installation.

### Surge category IV

- Equipment for use at or near the power supplies in the electrical installations of buildings, between the principal distribution and the mains, e.g. electricity meters, circuit-breakers and centralised ripple controllers.

## Pollution severity categories

### Pollution severity category 1

- No pollution, or only dry, non-conductive pollution that has no influence.

### Pollution severity category 2

- Non-conductive pollution only; occasional condensation may cause temporary conductivity.

### Pollution severity category 3

- Conductive pollution, or dry, non-conductive pollution that is liable to be rendered conductive through condensation.

### Pollution severity category 4

- Contamination results in constant conductivity, e.g. caused by conductive dust, rain or snow.

Unless explicitly stated otherwise, the measurement of clearance and creepage distances and the resulting rating data for electromechanical components is based on pollution severity 2 and surge category III, taking account of all network types.



# Derating curve (current-carrying capacity curve)

The **derating curve** shows which currents may flow continuously and simultaneously via all possible connections when the component is subjected to various ambient temperatures below its upper limit temperature.

The **upper limit temperature** of a component is the rated value determined by the materials used. The total of the ambient temperature plus the temperature rise caused by the current load (power loss at volume resistance) may not exceed the upper limit temperature of the component, otherwise it will be damaged or even completely ruined.

The current-carrying capacity is hence not a constant value, but rather decreases as the component ambient temperature increases. Furthermore, the current-carrying capacity is influenced by the geometry of the component, the number of poles and the conductor(s) connected to it.

The current-carrying capacity is determined empirically according to DIN IEC 60512-3. To do this, the resulting component temperatures  $t_{b1}$ ,  $t_{b2}$  and the ambient temperatures  $t_{u1}$ ,  $t_{u2}$  are measured for three different currents  $I_1$ ,  $I_2$ .

The values are entered on a graph with a system of linear coordinates to illustrate the relationships between the currents, the ambient temperatures and the temperature rise in the component.

**Base curve**

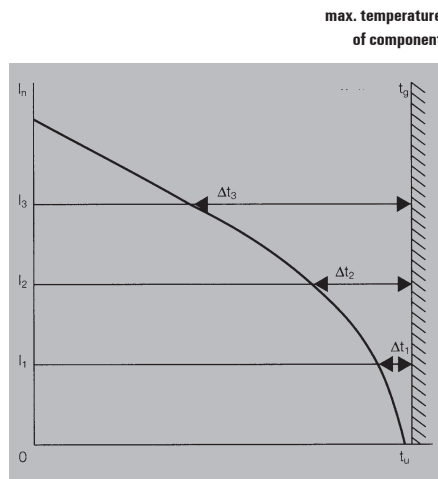

$t_g$  = maximum temperature of component  
 $t_u$  = ambient temperature  
 $I_n$  = current

The **loading currents** are plotted on the y-axis, the **component ambient temperatures** on the x-axis.

A line drawn perpendicular to the x-axis at the upper limit temperature  $t_g$  of the component completes the system of coordinates.

The associated average values of the temperature rise in the component,  $\Delta t_1 = t_{b1} - t_{u1}$ ,  $\Delta t_2 = t_{b2} - t_{u2}$ , are plotted for every current  $I_1$ ,  $I_2$  to the left of the perpendicular line.

The points generated in this way are joined to form a roughly parabolic curve.

As it is practically impossible to choose components with the maximum permissible volume resistances for the measurements, the base curve must be reduced.

**Derating curve**

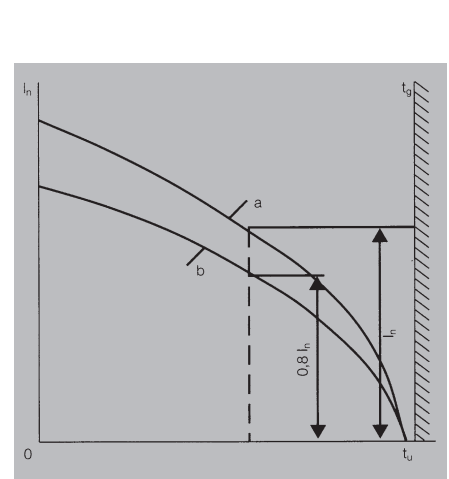

$t_g$  = maximum temperature of component  
 $t_u$  = ambient temperature  
 $I_n$  = current  
 a = base curve  
 b = reduced base curve (derating curve)

Reducing the currents to 80 % results in the **"derating curve"** in which the maximum permissible volume resistances and the measuring uncertainties in the temperature measurements are taken into account in such a way that they are suitable for practical applications, as experience has shown. If the derating curve exceeds the currents in the low ambient temperature zone, which is given by the current-carrying capacity of the conductor cross-sections to be connected, then the derating curve should be limited to the smaller current in this zone.

# IP class of protection to DIN EN 60529

The class of protection is indicated by a code consisting of the two letters IP and two digits representing the class of protection.

Example: **I P 6 5**  
 |        |  
       2nd digit: protection from liquids  
       1st digit: protection from solid bod

## Protection against intrusion of external particle matter (1st digit)

Digit		
0		No protection
1		Protection against ingress of large solid bodies with diameter > 50 mm. (Protection to prevent dangerous parts being touched with the back of the hand.)
2		Protection against ingress of large solid bodies with diameter > 12.5 mm. (Protection to prevent dangerous parts being touched with the fingers.)
3		Protection against ingress of large solid bodies with diameter > 2.5 mm. (Protection to prevent dangerous parts being touched with a tool.)
4		Protection against ingress of large solid bodies with diameter > 1 mm. (Protection to prevent dangerous parts being touched with a piece of wire.)
5		Protection against harmful deposits of dust, which cannot enter in an amount sufficient to interfere with satisfactory operation.
6		Complete protection against ingress of dust.

## Protection against penetration of liquids (2nd digit)

Digit		
0		No protection
1		Protection against drops of condensed water falling vertically.
2		Protection against drops of liquid falling at an angle of 15° with respect to the vertical.
3		Protection against drops of liquid falling at an angle of 60° with respect to the vertical.
4		Protection against liquids splashed from any direction.
5		Protection against water jets projected by a nozzle from any direction.
6		Protection against water from heavy sea on ships' decks.
7		Protection against immersion in water under defined conditions of pressure and time.
8		Protection against indefinite immersion in water under defined conditions of pressure (which must be agreed between manufacturer and user and must be more adverse than number 7).

# Glossary

## 1-9

<b>2-way isolation</b>	The input and output signals are separated electrically from each other and decoupled. Potential differences caused by long wire lengths and common reference points are eliminated.
<b>3-way isolation</b>	Also decouples the power supply to the input and output circuit and enables supply with only one operating voltage.

## A

<b>A/D converter</b>	Converts standardised analogue current and voltage signals into an 8-bit, 12-bit or 16-bit digital signal. It may be necessary to convert analogue signals into digital signals when you need the analogue signal from the surroundings to work with the typical digital processing requirements of process monitoring.
<b>AC</b>	Alternating current
<b>Accuracy</b>	Describes the ability of an analogue signal isolating converter to transmit a measured value as precisely as possible. It is specified in the percent deviation from the measuring range end value at room temperature.
<b>Active sensor</b>	In an active sensor, an electrical signal is generated from the measurement itself, for example dynamometric or piezo-electric. Thus no auxiliary power source is required. Because of their physical operating principals (since energy cannot be sent during the static and quasi-static states), only a change in the measured variable can be detected.
<b>Actuator</b>	The actuator is a sensor counterpart – it converts electrical current into another form of energy.
<b>Alarm contact</b>	A switching contact that activates when a disturbance occurs (for example, an overload or short circuit).
<b>Ambient temperature</b>	DIN EN 60204-1 uses this term to refer to the temperature of the surrounding air or medium at which the equipment can be properly and safely operated. This is a part of the surrounding physical and operational conditions. Failure to maintain this temperature level can invalidate the product warranty.
<b>Analogue signal</b>	A signal is designated as an analogue signal if it transmits parameter information that is infinitely variable between a minimum and maximum value (this includes instantaneous values such as current, voltage or temperature). This applies to practically all real-world processes or states. It is theoretically possible to register any small signal changes (there is a very large dynamic range).

<b>ATEX</b>	<p>The ATEX directive from 23.4.1994 is valid within the EU and the EFTA Western European nations. It applies to devices, machinery components, controllers and protective systems that are to be used in hazardous areas. This directive harmonises the different national regulations from the EU member nations concerning the proper and intended use of machines and facilities in hazardous areas.</p> <p><b>ATEX</b> is derived from the phrase “<b>AT</b>mosphere <b>EX</b>plosive”. It stipulates that operators should prevent explosions and ensure protection.</p> <p>Regarding explosion protection in a potentially explosive atmosphere, the ATEX directive 94/9/EC has precedence over machinery directives and must be followed. The directive describes the following steps:</p> <ul style="list-style-type: none"> <li>• Describe how often a potentially explosive atmosphere occurs and where it occurs.</li> <li>• These areas are then divided into zones according to the specifications.</li> <li>• Make sure that only properly categorised equipment is present within each different zone. As soon as an area is classified as being dangerous, steps must be taken to limit the potential ignition sources that are present there.</li> </ul>
-------------	--

## C

<b>Calibration device</b>	A special instrument used for the calibration and configuration of analogue signal conditioning devices. The calibration device produces highly precise standardised signals. It is equipped with a load indicator for quick loop diagnostics.
<b>CE</b>	Abbreviation for <b>C</b> ommunauté <b>E</b> uropéenne (the European Community). Manufacturers use the CE label to confirm that their products comply with the corresponding EC directives and the “essential requirements” therein.
<b>Cold-junction compensation</b>	Thermocouples require a temperature reference point to compensate for unwanted “cold junctions”. The usual method for achieving this is by measuring the temperature at the reference junction with a temperature sensor that can be read immediately. The interfering voltage can then be compensated for in the measurement results. This process is referred to as cold-junction compensation (CJC).
<b>Common-mode interference</b>	Interfering currents and voltages that can occur on the connecting cables between electrical devices and facility components. These can then spread with similar phase and current direction to the feed line and the return line.
<b>Counter</b>	A counter can be used for measuring flow or for counting events. Analogue or digital input signals (pulses) may also be processed. Integrated function such as linearisation, interference suppression, hysteresis configuration and reference values expand the range of use of a counter. Switching contacts are available on the output side for monitoring threshold.

## W

**Creepage and clearance distances**

The safety gaps between two current-carrying wires. The creepage distance is the shortest path along an insulating surface between two live components. The clearance distance is the shortest path in the air between two points of reference.

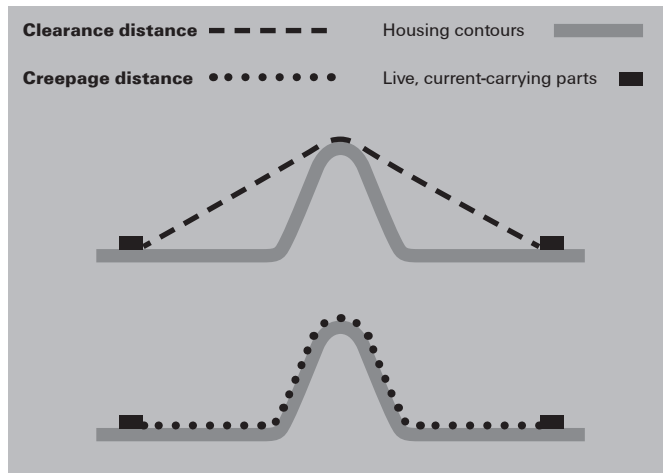

**D**

**D/A converter**

D/A converters convert standardised digital signals (for example, with an 8-bit structure) into analogue current and voltage signals. It may be necessary to convert digital signals into analogue signals when you need the analogue signal from the surroundings to work with the typical digital processing requirements of process monitoring.

**DC**

Direct current

**Derating**

The continuous current level reduction in relation to an ambient temperature increase, represented as a derating curve (a load reduction curve).

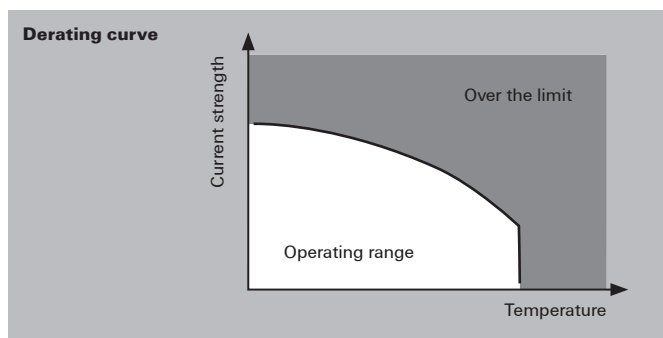

<b>Device categories</b>	The device category determines which equipment can be used in which zone. There are six device categories. The categories 1 G, 2 G and 3 G are classifications for gas explosion protection (G = Gas). Equipment with 1 G is suitable for zones 0, 1 and 2. Equipment with 2 G is suitable for zones 1 and 2. Equipment with 3 G is suitable for zone 2. The categories 1 D, 2 D and 3 D are classifications for dust explosion protection (D = Dust). Equipment with 1 D is suitable for zones 20, 21 and 22. Equipment with 2 D is suitable for zones 21 and 22. Equipment with 3 D is suitable for zone 22.
<b>Device groups</b>	Equipment is divided into groups I and II. Group I concerns underground mining while group II concerns explosion protection for gas and dust in all other applications.
<b>DTM</b>	DTMs ( <b>D</b> evice <b>T</b> ype <b>M</b> anager) are software drivers that are vendor- and device-neutral. DTMs define functions for access to device parameters, troubleshooting, configuration and operation of devices. The DTM specifies all device-specific information, functions and rules (such as the device structure, communication capabilities, internal dependencies and the human-machine interface (HMI)). Device manufacturers make available a Device Type Manager (DTM) software driver for each device or device group.

## E

<b>EIA-232/ RS232</b>	The term EIA-232 (originally RS232) refers to a serial interface standard developed by a U.S. standards committee (now known as the EIA – Electronic Industries Alliance) in the early 1960s. EIA-232 specifies the connection between the data terminal equipment (DTE) and the modem (data communication equipment or DCE). It defines timing, voltage level, plug and protocol details. EIA-232 defines a voltage interface. The information bits are encoded using electrical voltage. The data lines (TxD and RxD) use a negative logic whereby a voltage level between -3 V and -15 V (ANSI/EIA/TIA-232-F-1997) represents a logical one and a voltage level between +3 V and +15 V represents a logical zero. Signal levels between -3 V and +3 V are undefined.
<b>EIA-422/ RS422</b>	EIA-422 (also known as RS422) is an interface standard for cable-based differential, serial data transmission. In contrast to the asymmetric serial interface specified by the EIA-232 standard, the EIA-422 interface is designed for symmetric transmissions. This means that two sets of twisted pair wires are required to carry the positive and negative signals from the sender to the receiver. This minimises common-mode interferences and also increases the data rates in comparison to the asymmetric EIA-232 interface. EIA-422 can be used to establish a full-duplex, point-to-point connection. Multi-drop networks with one sender and up to ten receivers are also possible. The sender and receiver in multi-drop networks can only be operated in half-duplex (in one direction). Because of the high data rate (up to several MBit/s), a wire pair on the EIA-422 interface must be terminated with a terminating resistor (normally 120 ohm).

<b>EIA-485/ RS485</b>	EIA-485, also referred to as RS485, is an interface standard for digital, cable-based, differential, serial data transmissions. EIA-485 uses a wire pair for transmitting inverted and non-inverted levels for a single-bit data signal. The original data signal is reconstructed by the receiver as the difference between the two voltage levels. This has the advantage of increasing the resistance to interference, since common-mode interference then has no effect on the transmission. The EIA-485 interface operates with a voltage differential of +/-200 mV, so that the voltage interface has a differential related to half of the operational voltage. It normally uses a single wire pair and is operated in half-duplex. However full-duplex operations are possible with two wire pairs. This connection has multi-point capabilities; up to 32 nodes can be connected to an EIA-485 bus. Standard cable lengths run up to 1.2 km in length and support transmission speeds up to 10 MBit/s. The wire pairs must be terminated with resistors (typically 120 Ohm) because of the cable length and high data rates.
<b>Electrical equipment</b>	All of the electrical and electronic components and circuits within an enclosure.
<b>Explosion groups</b>	Depending on the ignition protection, explosion-protected equipment intended for gases, vapours and mists are divided into three explosion groups (IIA-IIB-IIC). The explosion group provides a measure of the explosive break-through capability of gases (in an explosive atmosphere). The requirements for the equipment increase in strictness from II A to II C.
<b>Explosion protection types</b>	<p>The ignition protection type is a term used in explosion protection that refers to the various types of protective construction designed into the product. Ignition protection types are formulated to minimise the risk that an ignition source will be present in an explosive atmosphere.</p> <p>The following ignition protection types are specified:</p> <ul style="list-style-type: none"> <li>• <b>For electrical equipment in a gas</b> <ul style="list-style-type: none"> <li>• Intrinsic safety Ex i</li> <li>• Pressure-resistant Ex d encapsulation</li> <li>• Increased safety Ex e</li> <li>• Pressurization encapsulation Ex p</li> <li>• Oil immersion Ex o</li> <li>• Moulded encapsulation Ex m</li> <li>• Sand encapsulation Ex q</li> <li>• Ignition protection type for zone 2 Ex n</li> <li>• Special ignition protection type Ex s</li> </ul> </li> <li>• <b>For electrical equipment in dust</b> <ul style="list-style-type: none"> <li>• Pressurization encapsulation Ex pD</li> <li>• Intrinsic safety Ex iD</li> <li>• Moulded encapsulation Ex mD</li> <li>• Protection provided by housing Ex tD</li> </ul> </li> </ul>

<b>Explosive atmospheres</b>	This is defined as a mixture of flammable materials and oxygen. An ignition leads to a explosive burning process throughout the entire mixture. Usually the oxygen is supplied by the surrounding air. Flammable materials may be gases, liquids, vapours, mists or dusts. Explosion protection considers this to be normal atmospheric conditions. The explosiveness of the mixture depends of the flammability of the materials and the concentration of air or oxygen.
------------------------------	---

**F**

<b>Flammability rating</b>	Flammability class specification according to the American UL 94 specification. Duration of burning, annealing time and the burning drop formation are all taken into account. The highest category is V-0.
<b>Frequency converter</b>	Converts frequencies into analogue signals (or vice versa). In-line control systems can then directly process pulse strings from speed or rotational measurements.

**G**

<b>Galvanic isolation</b>	Potential-free isolation between electrical components. Normally, the inputs circuit, output circuit and power supply are designed so that they are electrically isolated from each other. The isolation can be achieved using optical means (an optocoupler) or by using a transformer. The electrical isolation of measurement signals ensures that the differences in earth potentials and common-mode interference are suppressed
<b>GOST-R</b>	The Russian certification for products, materials and technical facilities.

**H**

<b>Hall sensor current measurement</b>	Hall sensors can measure the magnetic field of a conducting wire. They then generate a proportional voltage on the measurement output (the Hall voltage). This can be converted to a standardised signal by means of an amplifier circuit. Such a measurement is well suited for measuring high DC and AC currents with frequencies up to 1 kHz. Start-up currents and current peaks cannot damage a Hall sensor.
--	---

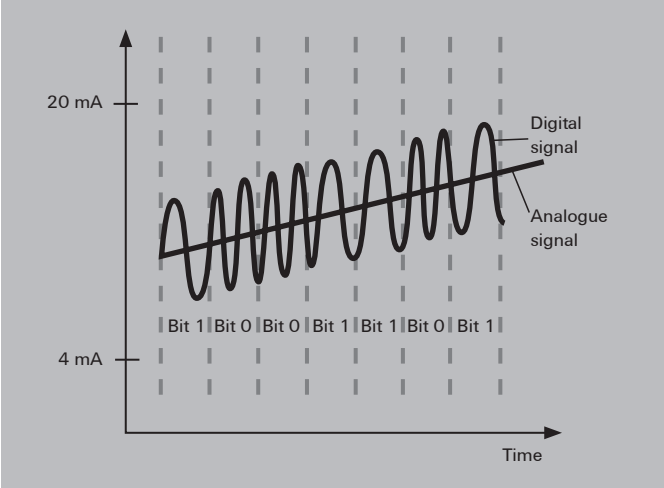

<b>HART®</b>	<p>HART® (Highway Addressable Remote Transducer) is a communications protocol for bus-addressed field devices used in process automation. In HART®-based communications, field devices and controllers are connected together over 4–20 mA current loops. This analogue signal is superimposed with a digital signal by using the FSK process (Frequency Shift Keying). The process allows additional measurements, configuration and device data to be transmitted without influencing the analogue signal. Ex isolators can also be used in hazardous areas.</p> 
<b>Hazardous area</b>	<p>According to the ATEX directive, an hazardous area is where the extent of the explosive atmosphere mandates that extra measures must be taken to safeguard health and protect surrounding machinery. Hazardous areas are classified according to the frequency and duration of the occurrence of the explosive atmosphere (refer to the sub-divided zones).</p>
<b>Hysteresis</b>	<p>Specifies the percent difference between the switch-on and switch-off points of a switching contact. The hysteresis must not fall below a minimal value. Otherwise it would no longer be possible to carry out specific switching during the monitoring of threshold.</p>
<b>I</b>	
<b>IECEX</b>	<p>An international directive regarding the creation of declarations of conformity by the manufacturers of facilities, devices and components that are intended for use in explosion risk zones. This directive is valid throughout the globe but is only currently used in some Asian nations.</p>
<b>Impulse withstand voltage</b>	<p>The high pulse voltage of a specified form and polarity that does not lead to an insulation breakthrough or flashover, under the specific conditions defined in EN 60664-1.</p>

<b>Initiator PNP/NPN switched</b>	Two wires in a three-wire sensor are responsible for keeping the supply activated. The third connecting wire is used for transferring commands (NO/NC contact). Initiators with NPN outputs switch the load in active mode towards the minus potential. Proximity switches with PNP outputs switch toward the plus potential.
<b>Insulation voltage</b>	For electronics components with electrical isolation, this is the maximum AC test voltage that can be applied for a specified time interval (5 s / 60 s) without causing a break-through.
<b>Intrinsic safety "i"</b>	Electrical equipment for hazardous areas with the ignition protection type "Intrinsic safety Ex i" Intrinsic safety is divided into ignition protection types "ia" or "ib" The ignition protection type "intrinsic safety" is a protective strategy that requires a complex analysis of electronic devices. So it is not only important to protect intrinsically safe current from the other unsafe circuits. It is also important to limit the open-circuit voltage, short-circuit current, power, stored energy and the surface temperature of components that will be exposed to the explosive atmosphere. Intrinsically safe circuits are circuits where a spark or thermal effect (as may occur under the testing conditions specified by EN 60079-1 1) is not capable of igniting an explosive atmosphere (of sub-groups IIA, IIB or IIC) or a dust-air mixture. The testing conditions cover normal operations and certain error conditions as specified in the standard.
<b>IP protection classes</b>	Equipment is assigned an IP protection class to indicate which environmental conditions it can be used in.
<b>Isolation amplifier (active isolator)</b>	An isolation amplifier is used to provide electrical isolation for analogue standard signals. They are designed with 2-way or 3-way isolation. The isolation of the potentials eliminates interference on the measurement signal that can be caused by earth loops or common-mode noise. The active isolator makes use of a separate voltage source for its power supply. It functions without feedback; a change on the output side load does not influence the input circuit.

## L

<b>Leakage current</b>	The current on the load side of an optocoupler that flows towards the output circuit while in a closed state.
<b>Limiting frequency</b>	The limiting frequency of an analogue signal isolating converter is that frequency where the output signal is reduced to $1/\sqrt{2}$ of the value of the input signal (approx. 70.7 % = -3 dB).
<b>Line break monitoring</b>	Analogue measuring transducer with wire-break detection capability that permanently monitors the input signal. In the event of a fault (a wire break), the output signal jumps up to a defined value over the nominal range so that a controller wired further down the circuit can evaluate the error.

## W

<b>Linearisation</b>	Temperature-dependent components normally do not have a linear characteristic curve. Their characteristic curves must be linearised so that they can be evaluated as precisely as possible. The measurement curves of thermocouples and temperature-dependent resistors (NTC/ PTC), in particular, exhibit significant deviation from an "ideal curve". In the linearisation process, the measurement signal is processed by a microprocessor and an ideal characteristic curve is generated which can then be analysed or processed further.
<b>Load cell</b>	A load cell is a special type of force sensor used in weighing systems (i.e., with scales). They are calibrated in grams (g), kilograms (kg) or tons (t). Load cells usually have a spring mechanism used as a force sensor. The spring is a specially shaped piece of metal whose shape changes slightly when under the influence of weight. This elastic deformation is recorded by strain gauges and converted into an electrical signal. Weights can be recorded ranging from a few hundred grams to several thousand tons.
<b>Load resistance (load)</b>	This is the load resistance on the output side of a measuring transducer or transmitter. For analogue current outputs, the load is 500–600 ohms maximum. Voltage outputs normally have a load of at least 10 kOhm.

## M

<b>Measurement isolating transformer</b>	Converts electric and non-electric input signals into standard analogue signals. At the same time it provides electrical isolation between the input and output (2-way isolation) or between the input, output and supply (3-way isolation). Measurement isolators are typically used to record temperatures (RTD, thermocouples) or for measuring current, voltage, power, frequency, resistance and conductivity.
<b>Measuring bridge</b>	Sensors based on Wheatstone bridge circuitry can capture force, pressure and torque. Relatively small length changes under 10 – 4 mm can be recorded using DMS strain gauges in the form of resistance changes. A typical application is for capturing measurements in load cells.

## N

<b>Namur sensor</b>	NAMUR-compliant sensors (The standardization commission for measuring and control technology in the German chemical industry) operate with a load-independent current. They have four modes so that an analogue evaluative unit can detect a sensor malfunction. 1) Current of 0 mA => wire break, circuit is open 2) Current of approx. 20 % of the max. value => Sensor ready, activated 3) Current of approx. 60 % of the max. value => Sensor ready, not activated 4) Current at max. value => short circuit, max. current NAMUR sensors are suited for use in hazardous areas.
<b>NEC 500 – 505</b>	The relevant directives for the classification of explosion protection in the USA. NEC 500 regulates the standard Ex classifications (class – division – model). The NEC 505 defines the zone model based on the European and IEC classifications.

<b>Nominal switching current – load side</b>	The permitted load current of a relay contact or semiconductor contact when in continuous operations.
<b>Nominal switching voltage – load side</b>	The switching voltage that a relay contact or semiconductor contact uses in relation to its application.

## O

<b>Output-current loop-powered</b>	Output loop powered 2-wire transmitters have a 4 – 20 mA output. The transmitter is supplied with power via the current loop on the output side. A typical loop consists of a regulated DC power supply, the 2-wire transmitter and a receiving device.
<b>Overvoltage category</b>	<p>The overvoltage categories are described in DIN EN 60664-1. The category dictates the insulation clearance gaps required. Category III is the default specification (EN 50178).</p> <ul style="list-style-type: none"> <li>• <b>Overvoltage category I</b> Devices that are intended to be connected to the permanent electrical building installation. The measures for limiting transient surge voltages to the proper level are taken outside of the device. The protective mechanisms can either be in the permanent installation or between the permanent installation and the device.</li> <li>• <b>Overvoltage category II</b> Devices that are intended to be connected to the permanent electrical building installation (such household appliances or portable tools).</li> <li>• <b>Overvoltage category III</b> Devices that are a part of the permanent installation and other devices where a higher degree of availability is required. This includes the distributor panels, power switches, distribution systems (including cable, busbars, distributor boxes, switches and outlets) that are part of the permanent installation, devices intended for industrial use, and devices that are continually connected to the permanent installation (such as stationary motors).</li> <li>• <b>Overvoltage category IV</b> Devices that are intended to be used on or near the power feed in a building's electrical installation – ranging from the main distribution to the mains power system. This includes electrical meters, surge protection switches and ripple control equipment.</li> </ul>

## W

## P

<b>Passive isolator/ input loop powered</b>	<p>Generates its power supply from the input signal (0/4–20 mA). The amount of current needed internally is so small that the measurement signal is not influenced. Transformers are used to provide the isolation between the input and the output.</p> <p>The advantages include: eliminates the influence of the mains power system, highly accurate, minimal signal delay, and minimal power used. Passive isolators do not function free from feedback; so a load change on the output circuit will automatically effect the input circuit as well.</p>
<b>Passive sensor</b>	<p>Contains passive components whose parameters can be changed by the measured variables. A primary electronic mechanism converts these parameters into electric signals. An auxiliary external power source is needed for the passive sensor. Passive sensors can be used to determine both static and semi-static measured variables. For this reason, the majority of sensors have a passive construction. Examples of this type include load cells and resistance thermometers.</p>
<b>Pollution severity level</b>	<p>The pollution severity level specifies the conditions of the immediate surroundings. It is defined in DIN EN 50 178, Section 5.2.15.2.</p> <p>The pollution (contamination) severity level should be used to determine the required creepage distance for the insulation. Pollution degree 2 is the default specification.</p> <ul style="list-style-type: none"> <li>• <b>Pollution severity level 1</b> There is no contamination or only dry occurrences of non-conductive pollution. This pollution has no influence.</li> <li>• <b>Pollution severity level 2</b> There is only non-conductive pollution. Temporary occurrences of conductivity caused by condensation may also occur.</li> <li>• <b>Pollution severity level 3</b> Conductive pollution or dry, non-conductive pollution that can become conductive due to condensation is likely to occur.</li> <li>• <b>Pollution severity level 4</b> The contamination leads to continual conductivity which can be caused by such contaminants as conductive dust, rain or snow.</li> </ul>

## R

<b>Rated voltage</b>	<p>Specified by the insulation coordination – the rated voltage is the voltage level at which the product can be safely operated, in relation to the corresponding pollution severity level and the surge voltage category.</p>
<b>Relative humidity</b>	<p>The relationship between the actual moisture and the maximum possible quantity of water in the air. Expressed as a percentage.</p>

<b>RoHS</b>	The EC directive 2002/95/EC – concerning the restriction of the use of certain hazardous substances in electrical and electronic equipment – regulates the use of hazardous materials within devices and components. This directive, and its various implementations into national laws, are referred to by the abbreviation RoHS (Restriction of Hazardous Substances).
<b>RTD/ PT100/ 1000</b>	<p>RTD sensors are temperature probes that operate based on the resistance changes which take in metal as the temperature changes. They are resistance thermometers based on PTC resistors. The electrical changes in resistance of a platinum wire or platinum film is often used for measuring temperatures ranging from -200 °C to 850 °C. The platinum temperature sensors are characterised by their nominal resistance R<sub>0</sub> at a temperature of 0 °C. The standard types include:</p> <ul style="list-style-type: none"> <li>• PT100 (R<sub>0</sub>= 100 Ohm)</li> <li>• PT1000 (R<sub>0</sub>= 1 kOhm)</li> </ul> <p>A two-wire, three-wire or four-wire electrical connection can be used to electrically connect the PT/RTD sensor to the evaluative electronics. A three-wire or four-wire method eliminates any errors caused by the inherent resistance of the sensor connecting wires.</p> <p>In the three-wire method, one end is equipped with two pigtail connectors. In the four-wire method, both ends are equipped with two pigtail connectors.</p>

## S

<b>Self-heating</b>	Self-heating refers to the temperature increase in an operating device caused by the internal power loss.
<b>Sensor</b>	A sensor is a physical component capable of capturing certain physical or chemical properties (such as thermal radiation, temperature, humidity, pressure, noise, brightness or acceleration) as a measurement. It may also be able to analyse the quality of the composition of the material surroundings. These values are captured using physical or chemical phenomena and then converted into another form (usually electrical signals) so they can be post-processed.
<b>Signal distributorsplitter</b>	A signal isolator that accepts an analogue input signal and delivers at least two signals on the output side. This permits the signal to be transmitted to a PLC/DCS system and to a separate display. A signal multiplier is designed either as an active isolator with an external power feed or as an output loop powered version.
<b>SIL</b>	<p><b>Safety Integrity Level.</b></p> <p>The components must meet the requirements of IEC 61508 in order to reduce risk. This standard provides general requirements for avoiding and minimising device and equipment outages. It stipulates organization and technical requirements concerning device development and operation. Four safety levels are defined (from SIL1 for minimal risk to SIL4 for very high risk) for classifying facilities and risk-reduction measures. Risk-reduction measures must be more reliable when the classified risk level is higher.</p>
<b>Status indicator</b>	An LED that displays the operational status, such as operational (yellow), switching (green), and alarm/malfunction (red).
<b>Step response time</b>	This is the time delay in the output signal change when there is a signal jump ranging from 10 to 90 % on the input side. The step response time is inversely proportional to the limiting frequency
<b>Storage temperature</b>	The permitted ambient temperature, related to a specific relative humidity level, for which the product should be stored while in a current-free state.

## W

<b>Switching threshold</b>	The switch-on or switch-off point.
----------------------------	------------------------------------

## T

<b>Temperature classes</b>	<p>Explosion-protected equipment that is to be installed into the Ex zone is subdivided into six temperature classes (T1 to T6).</p> <p>These temperature classes define the maximum surface temperature permitted for the equipment. The definition is based on an ambient temperature of +40 °C. This temperature may not be exceeded on any part of the equipment at any point in time. In all cases, the maximum surface temperature must be lower than the ignition temperature of the surrounding medium. The requirements placed on the equipment become stricter from class T1 to T6.</p>
----------------------------	---

<b>Temperature coefficient</b>	<p>The temperature coefficient describes the relative change of a physical variable based on the temperature change relative to a reference temperature (room temperature). It directly influences the precision of an analogue signal converter. The coefficient is specified in ppm/K of the corresponding measuring range end value.</p>
--------------------------------	---

<b>Thermocouple</b>	<p>A thermocouple is a component made of two different materials which are connected to each other at one end. An electrical voltage is created (based on the principle of the Seebeck effect) along a wire that connects the unattached ends when there is a temperature differential.</p> <p>The juncture point and the unattached ends must have different temperatures for a voltage to be generated.</p>
---------------------	---

The following thermocouples are used for industrial applications:

Thermal pair	Short name	Type	Temperature range in °C
Nickel/Chrome-Nickel/Al	NiCr-Ni/Al	K	-200 ... +1372
Iron-constantan	Fe-CuNi	J	-200 ... +1200
Copper-constantan	Cu-CuNi	T	-200 ... +400
Nickel/Chrome constantan	NiCr-CuNi	E	-200 ... +1000
Platinum/10 % Rhodium-Platinum	Pt10Rh-Pt	S	-50 ... +1760
Platinum/13 % Rhodium-Platinum	Pt13Rh-Pt	R	-50 ... +1760
Nickel/Chrome-Nickel/Magnesium	NiCr-NiMg	N	-200 ... +1300
Platinum/30 % Rhodium - Platinum/6 % Rhodium	Pt30Rh - Pt6Rh	B	0 ... +1820

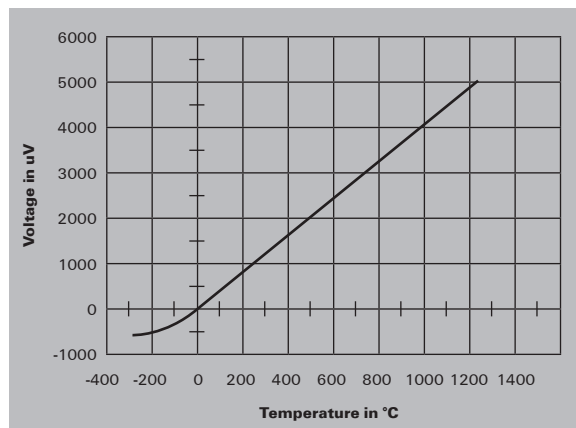

<b>Threshold monitoring</b>	The limiting values of physical variables must be continually monitored for industrial processes. This includes fill levels, temperatures, speed, positions, weights and frequencies. Specialised threshold monitoring components are used for this purpose. The sensor signals are captured on the input side, evaluated electronically and converted. The corresponding threshold (min/max) are then made available via the digital switching outputs (relays or transistors) to the external devices. Potentiometers can be used to customise each switching point and its minimum/maximum threshold as well as the switching hysteresis.
<b>Transformer-based current measurement</b>	Signal converters with transformer coupling are used for taking cost-effective measurements of sinusoidal currents (50/60 Hz). The current being measured flows directly through the primary coil of the measurement transformer. It is then stepped down and electronically processed in the converter.
<b>True RMS value</b>	True RMS is the measure of the active component of alternating current and voltages. The root mean square (RMS) is a measure of the magnitude of varying quantities (such as alternating current and voltage). It is a constant value that relates to the power consumed by a resistive load in a specified time period. The RMS is dependent on the amplitude and the curve slope. Non-sinusoidal signals can only be measured and processed with "true RMS"-compliant devices.
<b>TTY</b>	The TTY interface is a serial interface. This interface is often referred to as a 20-mA-current interface since a constant DC current of 20 mA flows through it during the idle state. In contrast to RS232, the data transmission for the asymmetric signal connection is not controlled by voltage changes but by a load-independent line current (typically 20 mA for High and 0 mA for Low). Thus there is no significant length-dependent voltage loss to take into consideration. Here the cable lengths can run up to several kilometres. TTY interfaces are currently used mostly where dedicated connections are required: for exchanging data between electronic scales, for large industrial displays, or for log printers.
<b>Type of contact</b>	A contact is called normally open (NO) or a make contact if it is open when the armature is dropped out (no current in coil) and closed when the armature is picked up (current flowing in coil). A contact is called a break contact or normally closed (NC) contact if it interrupts the circuit when the armature is picked up. A combination of NC and NO is called a changeover (CO) contact. A relay may have one or more of such contacts: NC – Normally Closed = break contact (1 1, 12: NC contact) NO – Normally Open = make contact ( 13, 14: NO contact) CO – Change Over contact (1 1, 12, 14: CO contact (1 1 is the shared (root) contact))



## Z

### Zone division

Hazardous areas are divided into zones. These divisions take into account the various risks from explosive atmospheres. The corresponding explosion protection can then be implemented economically and safely in accordance with the particular conditions of the zone. The zone definitions in the ATEX directive provide comprehensive regulations for the European Community.

IEC 60079-10 is valid for gases and vapours. A similar classification is used for facilities in the USA which are covered by the US standard NEC 505.

IEC 61241-3 covers the division into zones according to the dust level.

Explosion risk areas are classified into zones according to likelihood of explosive atmospheres occurring and their persistence:

**Zone 0:** this zone has an explosive atmosphere that is a mixture of air and flammable gases, vapours or mists. The mixture is present frequently or over long periods.

**Zone 1:** an explosive atmosphere may occasionally occur in this zone under normal operating conditions.

**Zone 2:** an explosive atmosphere is not likely to occur in this zone or may only occur briefly.

**Zone 20:** this zone has an explosive atmosphere that is a flammable mixture of air and dust. The mixture is present often or over long periods.

**Zone 21:** an explosive atmosphere, in the form of a flammable dust/air mixture, may occasionally occur in this zone under normal operating conditions.

**Zone 22:** an explosive atmosphere, in the form of a flammable dust/air mixture, is not likely to occur in this zone or may only occur briefly.

## Glossary

W



W

# Index

---

<b>Index</b>	Index Type	X.2
	Index Order No.	X.4
	Addresses worldwide	X.6

---

Type	Order No.	Page
<b>A</b>		
ACT20-FEED-IN-BASIC-S	1282490000	K.2
ACT20-FEED-IN-BASIC-S	1282490000	K.9
ACT20-FEED-IN-BASIC-S	1282490000	X
ACT20-FEED-IN-PRO-P	2456870000	K.2
ACT20-FEED-IN-PRO-P	2456870000	K.9
ACT20-FEED-IN-PRO-P	2456870000	X
ACT20-FEED-IN-PRO-S	8965500000	K.2
ACT20-FEED-IN-PRO-S	8965500000	K.9
ACT20-FEED-IN-PRO-S	8965500000	X
ACT20C-CML-10-AD-RCS	2044840000	B.4
ACT20C-CML-10-AD-RCS	2044840000	B.8
ACT20C-CML-10-AD-RCS	2044840000	IV
ACT20C-CMT-10-AD-RCS	1510240000	B.4
ACT20C-CMT-10-AD-RCS	1510240000	B.7
ACT20C-CMT-10-AD-RCS	1510240000	IV
ACT20C-CMT-60-AD-RCS	1510420000	B.4
ACT20C-CMT-60-AD-RCS	1510420000	B.7
ACT20C-CMT-60-AD-RCS	1510420000	IV
ACT20C-GTW-100-MTCP-S	1510370000	B.4
ACT20C-GTW-100-MTCP-S	1510370000	B.6
ACT20C-GTW-100-MTCP-S	1510370000	IV
ACT20C-LBT-10	1510340000	B.4
ACT20C-LBT-10	1510340000	B.9
ACT20C-LBT-10	1510340000	IV
ACT20M-2CI-2CD-ILP-S	1176080000	E.4
ACT20M-2CI-2CD-ILP-S	1176080000	E.10
ACT20M-2CI-2CD-ILP-S	1176080000	VIII
ACT20M-2CI-2CD-OLP-S	1176050000	E.8
ACT20M-2CI-2CD-OLP-S	1176050000	E.11
ACT20M-2CI-2CD-OLP-S	1176050000	VIII
ACT20M-AI-2AO-S	1176020000	E.4
ACT20M-AI-2AO-S	1176020000	E.13
ACT20M-AI-2AO-S	1176020000	VIII
ACT20M-AI-AD-E-S	1176010000	E.4
ACT20M-AI-AD-E-S	1176010000	E.8
ACT20M-AI-AD-E-S	1176010000	VIII
ACT20M-AI-AD-S	1176000000	E.4
ACT20M-AI-AD-S	1176000000	E.7
ACT20M-AI-AD-S	1176000000	VIII
ACT20M-AI-AD-S	1375470000	E.4
ACT20M-AI-AD-S	1375470000	E.14
ACT20M-AI-AD-S	1375470000	VIII
ACT20M-AI-AD-S	1375450000	E.9
ACT20M-AI-AD-S	1375450000	E.11
ACT20M-AI-AD-S	1375450000	VIII
ACT20M-AI-AD-S	1175990000	E.4
ACT20M-AI-AD-S	1175990000	E.12
ACT20M-AI-AD-S	1175990000	VIII
ACT20M-AI-AD-S	1176070000	E.4
ACT20M-AI-AD-S	1176070000	E.10
ACT20M-AI-AD-S	1176070000	VIII
ACT20M-AI-AD-S	1176040000	E.4
ACT20M-AI-AD-S	1176040000	E.11
ACT20M-AI-AD-S	1176040000	VIII
ACT20M-AI-AD-S	1175980000	E.4
ACT20M-AI-AD-S	1175980000	E.6
ACT20M-AI-AD-S	1175980000	VIII
ACT20M-AI-AD-S	1435590000	E.4
ACT20M-AI-AD-S	1435590000	E.15
ACT20M-AI-AD-S	1435590000	VIII
ACT20M-AI-AD-S	1375200000	E.4
ACT20M-AI-AD-S	1375200000	E.18
ACT20M-AI-AD-S	1375200000	VIII
ACT20M-AI-AD-S	1375510000	E.4
ACT20M-AI-AD-S	1375510000	E.17
ACT20M-AI-AD-S	1375510000	VIII
ACT20M-AI-AD-S	1435610000	E.4
ACT20M-AI-AD-S	1435610000	E.16
ACT20M-AI-AD-S	1435610000	VIII
ACT20M-AI-AD-S	1375500000	E.4
ACT20M-AI-AD-S	1375500000	E.20
ACT20M-AI-AD-S	1375500000	VIII
ACT20M-AI-AD-S	1375480000	E.4
ACT20M-AI-AD-S	1375480000	E.19
ACT20M-AI-AD-S	1375480000	VIII
ACT20M-AI-AD-S	1176030000	E.4
ACT20M-AI-AD-S	1176030000	E.21
ACT20M-AI-AD-S	1176030000	VIII
ACT20P-2CI-2CD-12-P	2489730000	D.4
ACT20P-2CI-2CD-12-P	2489730000	D.8
ACT20P-2CI-2CD-12-P	2489730000	VI
ACT20P-2CI-2CD-12-S	7760054112	D.4
ACT20P-2CI-2CD-12-S	7760054117	D.8
ACT20P-2CI-2CD-12-S	7760054117	VI
ACT20P-2CI-2CD-ILP-S	7760054124	D.4
ACT20P-2CI-2CD-ILP-S	7760054124	D.11
ACT20P-2CI-2CD-ILP-S	7760054124	VI
ACT20P-AI-AD-DC-P	2456860000	D.4
ACT20P-AI-AD-DC-P	2456860000	D.25
ACT20P-AI-AD-DC-P	2456860000	VI
ACT20P-AI-AD-DC-S	1474200000	D.25
ACT20P-AI-AD-DC-S	1474200000	D.25
ACT20P-BRIDGE-P	2456820000	D.4
ACT20P-BRIDGE-P	2456820000	D.22
ACT20P-BRIDGE-P	2456820000	VI
ACT20P-BRIDGE-S	1067250000	D.4

Type	Order No.	Page
ACT20P-BRIDGE-S	1067250000	D.22
ACT20P-BRIDGE-S	1067250000	VI
ACT20P-CI-2CD-OLP-S	7760054122	D.4
ACT20P-CI-2CD-OLP-S	7760054122	D.13
ACT20P-CI-2CD-OLP-S	7760054122	VI
ACT20P-CI-2CD-P	2489710000	D.4
ACT20P-CI-2CD-P	2489710000	D.14
ACT20P-CI-2CD-P	2489710000	VI
ACT20P-CI-2CD-S	7760054115	D.4
ACT20P-CI-2CD-S	7760054115	D.14
ACT20P-CI-2CD-S	7760054115	VI
ACT20P-CI-CD-ILP-S	7760054123	D.4
ACT20P-CI-CD-ILP-S	7760054123	D.11
ACT20P-CI-CD-ILP-S	7760054123	VI
ACT20P-CI-CD-P	2489680000	D.4
ACT20P-CI-CD-P	2489680000	D.7
ACT20P-CI-CD-P	2489680000	VI
ACT20P-CI-CD-S	7760054115	D.4
ACT20P-CI-CD-S	7760054115	D.14
ACT20P-CI-CD-S	7760054115	VI
ACT20P-CI-CD-OLP-S	7760054114	D.4
ACT20P-CI-CD-OLP-S	7760054114	D.7
ACT20P-CI-CD-OLP-S	7760054114	VI
ACT20P-CI-VO-P	2489740000	D.4
ACT20P-CI-VO-P	2489740000	D.9
ACT20P-CI-VO-P	2489740000	VI
ACT20P-CI-VO-S	1540010000	D.4
ACT20P-CI-VO-S	1540010000	D.9
ACT20P-CI-VO-S	1540010000	VI
ACT20P-CI-1-CD-OLP-S	7760054118	D.4
ACT20P-CI-1-CD-OLP-S	7760054118	D.12
ACT20P-CI-1-CD-OLP-S	7760054118	VI
ACT20P-CI-2-CD-OLP-S	7760054119	D.4
ACT20P-CI-2-CD-OLP-S	7760054119	D.12
ACT20P-CI-2-CD-OLP-S	7760054119	VI
ACT20P-CML-10-AD-RCP	2489910000	D.4
ACT20P-CML-10-AD-RCP	2489910000	D.20
ACT20P-CML-10-AD-RCP	2489910000	VI
ACT20P-CML-10-AD-RCS	2044850000	D.4
ACT20P-CML-10-AD-RCS	2044850000	D.20
ACT20P-CML-10-AD-RCS	2044850000	VI
ACT20P-CMT-10-AD-RCP	1510330000	D.4
ACT20P-CMT-10-AD-RCP	1510330000	D.21
ACT20P-CMT-10-AD-RCP	1510330000	VI
ACT20P-CMT-10-AD-RCS	1510470000	D.4
ACT20P-CMT-10-AD-RCS	1510470000	D.21
ACT20P-CMT-10-AD-RCS	1510470000	VI
ACT20P-CMT-30-AD-RCP	1510320000	D.4
ACT20P-CMT-30-AD-RCP	1510320000	D.21
ACT20P-CMT-30-AD-RCP	1510320000	VI
ACT20P-CMT-30-AD-RCS	1510540000	D.4
ACT20P-CMT-30-AD-RCS	1510540000	D.21
ACT20P-CMT-30-AD-RCS	1510540000	VI
ACT20P-CMT-60-AD-RCP	1510290000	D.4
ACT20P-CMT-60-AD-RCP	1510290000	D.21
ACT20P-CMT-60-AD-RCP	1510290000	VI
ACT20P-CMT-60-AD-RCS	1510290000	D.4
ACT20P-CMT-60-AD-RCS	1510440000	D.21
ACT20P-CMT-60-AD-RCS	1510440000	VI
ACT20P-CMT-60-RCP	1510280000	D.21
ACT20P-CMT-60-RCP	1510280000	VI
ACT20P-CMT-60-RCS	1510390000	D.4
ACT20P-CMT-60-RCS	1510390000	D.21
ACT20P-CMT-60-RCS	1510390000	VI
ACT20P-PRO DCDC II-P	1481960000	D.4
ACT20P-PRO DCDC II-P	1481960000	D.23
ACT20P-PRO DCDC II-P	1481960000	VI
ACT20P-PRO DCDC II-S	1481970000	D.4
ACT20P-PRO DCDC II-S	1481970000	D.23
ACT20P-PRO DCDC II-S	1481970000	VI
ACT20P-PRO RTCA-AD-DD-P	2448110000	D.4
ACT20P-PRO RTCA-AD-DD-P	2448110000	D.16
ACT20P-PRO RTCA-AD-DD-P	2448110000	VI
ACT20P-PRO RTCA-AD-DD-S	2448100000	D.4
ACT20P-PRO RTCA-AD-DD-S	2448100000	D.16
ACT20P-PRO RTCA-AD-DD-S	2448100000	VI
ACT20P-PRO RTCA-AD-DD-S	2448100000	D.18
ACT20P-PRO RTCA-AD-DD-S	2448100000	D.18
ACT20P-TMR-RTI-S	7760054305	D.4
ACT20P-TMR-RTI-S	7760054305	D.15
ACT20P-TMR-RTI-S	7760054305	VI
ACT20P-UI-2RCD-ACP	2495690000	D.4
ACT20P-UI-2RCD-ACP	2495690000	D.17
ACT20P-UI-2RCD-ACP	2495690000	VI
ACT20P-UI-2RCD-ACS	1238910000	D.4
ACT20P-UI-2RCD-ACS	1238910000	D.17
ACT20P-UI-2RCD-ACS	1238910000	VI
ACT20P-UI-2RCD-DC-P	2456840000	D.4
ACT20P-UI-2RCD-DC-P	2456840000	D.17
ACT20P-UI-2RCD-DC-P	2456840000	VI
ACT20P-UI-2RCD-DC-S	7940045760	D.4
ACT20P-UI-2RCD-DC-S	7940045760	D.17
ACT20P-UI-2RCD-DC-S	7940045760	VI
ACT20P-UI-AD-DOLPP	2456850000	D.4
ACT20P-UI-AD-DOLPP	2456850000	D.24
ACT20P-UI-AD-DOLPP	2456850000	VI
ACT20P-UI-AD-DOLP-P	1453210000	D.4
ACT20P-UI-AD-DOLP-P	1453210000	D.24
ACT20P-UI-AD-DOLP-P	1453210000	VI
ACT20P-UI-AD-DOLP-S	1453210000	D.4
ACT20P-UI-AD-DOLP-S	1453210000	D.24
ACT20P-UI-AD-DOLP-S	1453210000	VI
ACT20P-UI-CD-OLP-S	7760054121	D.4
ACT20P-UI-CD-OLP-S	7760054121	D.12
ACT20P-UI-CD-OLP-S	7760054121	VI
ACT20P-VI-CD-OLP-S	7760054120	D.4

Type	Order No.	Page
ACT20P-VI-CD-OLP-S	7760054120	D.12
ACT20P-VI-CD-OLP-S	7760054120	VI
ACT20P-VI-CD-OLP-S	7760054306	D.4
ACT20P-VI-AD-S	7760054306	D.10
ACT20P-VI-AD-S	7760054306	VI
ACT20P-VMR-1PH-H-S	7760054164	D.4
ACT20P-VMR-1PH-H-S	7760054164	D.18
ACT20P-VMR-1PH-H-S	7760054164	VI
ACT20P-VMR-3PH-ILP-H-S	7760054165	D.4
ACT20P-VMR-3PH-ILP-H-S	7760054165	D.19
ACT20P-VMR-3PH-ILP-H-S	7760054165	VI
ACT20X-2HAI-2SAO-P	2456150000	C.4
ACT20X-2HAI-2SAO-P	2456150000	C.7
ACT20X-2HAI-2SAO-P	2456150000	VI
ACT20X-2HAI-2SAO-S	8965440000	C.4
ACT20X-2HAI-2SAO-S	8965440000	C.7
ACT20X-2HAI-2SAO-S	8965440000	VI
ACT20X-2HAI-2SDO-P	2456100000	C.4
ACT20X-2HAI-2SDO-P	2456100000	C.15
ACT20X-2HAI-2SDO-P	2456100000	VI
ACT20X-2HAI-2SDO-RNC-P	2456090000	C.4
ACT20X-2HAI-2SDO-RNC-P	2456090000	VI
ACT20X-2HAI-2SDO-RNC-S	8965380000	C.4
ACT20X-2HAI-2SDO-RNC-S	8965380000	C.13
ACT20X-2HAI-2SDO-RNC-S	8965380000	VI
ACT20X-2HAI-2SDO-RNO-P	2456080000	C.4
ACT20X-2HAI-2SDO-RNO-P	2456080000	C.13
ACT20X-2HAI-2SDO-RNO-P	2456080000	VI
ACT20X-2HAI-2SDO-RNO-S	8965370000	C.4
ACT20X-2HAI-2SDO-RNO-S	8965370000	C.13
ACT20X-2HAI-2SDO-RNO-S	8965370000	VI
ACT20X-2HAI-2SDO-S	8965390000	C.4
ACT20X-2HAI-2SDO-S	8965390000	C.15
ACT20X-2HAI-2SDO-S	8965390000	VI
ACT20X-2HAI-2SDO-S	2456190000	C.4
ACT20X-2HAI-2SDO-S	2456190000	C.11
ACT20X-2HAI-2SDO-S	2456190000	VI
ACT20X-2HAI-2SAO-S	8965480000	C.4
ACT20X-2HAI-2SAO-S	8965480000	C.11
ACT20X-2HAI-2SAO-S	8965480000	VI
ACT20X-2SAI-2HAO-P	2456170000	C.4
ACT20X-2SAI-2HAO-P	2456170000	C.9
ACT20X-2SAI-2HAO-P	2456170000	VI
ACT20X-2SAI-2HAO-S	8965460000	C.4
ACT20X-2SAI-2HAO-S	8965460000	C.9
ACT20X-2SAI-2HAO-S	8965460000	VI
ACT20X-2SDI-2HDO-P	2456130000	C.17
ACT20X-2SDI-2HDO-S	89654200	

Type	Order No.	Page
------	-----------	------

## M

MCZ CCC 0-20MA/0-20MA	8411190000	F.4
MCZ CCC 0-20MA/0-20MA	8411190000	F.8
MCZ CCC 0-20MA/0-20MA	8411190000	VIII
MCZ CFC 0-20MA	8461480000	F.4
MCZ CFC 0-20MA	8461480000	F.6
MCZ CFC 0-20MA	8461480000	VIII
MCZ CFC 4-20MA	8461490000	F.4
MCZ CFC 4-20MA	8461490000	F.6
MCZ CFC 4-20MA	8461490000	VIII
MCZ PT100/3 CLP 40C...100C	8604430000	F.4
MCZ PT100/3 CLP 40C...100C	8604430000	F.9
MCZ PT100/3 CLP 40C...100C	8604430000	VIII
MCZ PT100/3 CLP 50C...+150C	8473000000	F.4
MCZ PT100/3 CLP 50C...+150C	8473000000	F.9
MCZ PT100/3 CLP 50C...+150C	8473000000	VIII
MCZ PT100/3 CLP 0...100C	8425720000	F.4
MCZ PT100/3 CLP 0...100C	8425720000	F.9
MCZ PT100/3 CLP 0...100C	8425720000	VIII
MCZ PT100/3 CLP 0...120C	8483680000	F.4
MCZ PT100/3 CLP 0...120C	8483680000	F.9
MCZ PT100/3 CLP 0...120C	8483680000	VIII
MCZ PT100/3 CLP 0...150C	8604420000	F.4
MCZ PT100/3 CLP 0...150C	8604420000	F.9
MCZ PT100/3 CLP 0...150C	8604420000	VIII
MCZ PT100/3 CLP 0...200C	8473010000	F.4
MCZ PT100/3 CLP 0...200C	8473010000	F.9
MCZ PT100/3 CLP 0...200C	8473010000	VIII
MCZ PT100/3 CLP 0...300C	8473020000	F.4
MCZ PT100/3 CLP 0...300C	8473020000	F.9
MCZ PT100/3 CLP 0...300C	8473020000	VIII
MCZ SC 0-10V	8260280000	F.4
MCZ SC 0-10V	8260280000	F.7
MCZ SC 0-10V	8260280000	VIII
MCZ SC 0-20MA	8227350000	F.4
MCZ SC 0-20MA	8227350000	F.7
MCZ SC 0-20MA	8227350000	VIII
MCZ VFC 0-10V	8461470000	F.4
MCZ VFC 0-10V	8461470000	F.6
MCZ VFC 0-10V	8461470000	VIII
MF 5/7.5 MC NE WS	1877680000	K.11

## P

P275	7940010202	K.17
PAS CMR 0.5...2.5 A DC	8742610000	H.4
PAS CMR 0.5...2.5 A DC	8742610000	H.12
PAS CMR 0.5...2.5 A DC	8742610000	X
PAS CMR 2.0...5.0 A DC	8742620000	H.4
PAS CMR 2.0...5.0 A DC	8742620000	H.12
PAS CMR 2.0...5.0 A DC	8742620000	X
PAS CMR 4.5...10 A DC	8742630000	H.4
PAS CMR 4.5...10 A DC	8742630000	H.13
PAS CMR 4.5...10 A DC	8742630000	X
PICOPAK-CI-CO-LP-P	2501110000	G.4
PICOPAK-CI-CO-LP-P	2501110000	G.6
PICOPAK-CI-CO-LP-P	2501110000	VIII
PICOPAK-CI-CO-LP-S	2517450000	G.4
PICOPAK-CI-CO-LP-S	2517450000	G.6
PICOPAK-CI-CO-LP-S	2517450000	VIII
PMX400HZX	7940015595	I.2
PMX400HZX	7940015595	I.8
PMX400HZX	7940015595	X
PMX400HZX RO/AO	7940011979	I.2
PMX400HZX RO/AO	7940011979	I.8
PMX400HZX RO/AO	7940011979	X
PMX420	7940018956	I.2
PMX420	7940018956	I.7
PMX420	7940018956	X
PMX420PLUS	7940018957	I.2
PMX420PLUS	7940018957	I.6
PMX420PLUS	7940018957	X
PORTACAL 1000EU	1439640000	K.15
PTX800A 4-20MA	7940010243	I.2
PTX800A 4-20MA	7940010243	I.5
PTX800A 4-20MA	7940010243	X
PTX800A 4-20MA/RO/AO	7940014374	I.2
PTX800A 4-20MA/RO/AO	7940014374	I.5
PTX800A 4-20MA/RO/AO	7940014374	X
PTX800D	7940011133	I.2
PTX800D	7940011133	I.4
PTX800D	7940011133	X
PTX800D RO/AO	7940012323	I.2
PTX800D RO/AO	7940012323	I.4
PTX800D RO/AO	7940012323	X

## S

SET CH20M BUS 250MM TS 35X15	1335150000	K.7
SET CH20M BUS 250MM TS 35X7.5	1335140000	K.7
SW Weidmüller DTM-Library Setup	1466380000	J.4

## T

TS 35X15/LL 1M/ST/ZN	0236510000	K.7
TS 35X7.5/LL 1M/ST/ZN	0514510000	K.7

Type	Order No.	Page
------	-----------	------

## W

WAS1 CMA LP 1/5/10A AC	8528650000	H.4
WAS1 CMA LP 1/5/10A AC	8528650000	H.8
WAS1 CMA LP 1/5/10A AC	8528650000	X
WAS1 CMA LP 1/5/10A EX	8975590000	H.4
WAS1 CMA LP 1/5/10A EX	8975590000	H.8
WAS1 CMA LP 1/5/10A EX	8975590000	X
WAS5 DC/ALARM	8543820000	H.4
WAS5 DC/ALARM	8543820000	H.11
WAS5 DC/ALARM	8543820000	X
WAS6 TTA	8939670000	H.4
WAS6 TTA	8939670000	H.6
WAS6 TTA	8939670000	X
WAS6 TTA EX	8964310000	H.4
WAS6 TTA EX	8964310000	H.7
WAS6 TTA EX	8964310000	X
WAZ1 CMA LP 1/5/10A AC	8528660000	H.4
WAZ1 CMA LP 1/5/10A AC	8528660000	H.8
WAZ1 CMA LP 1/5/10A AC	8528660000	X
WAZ5 DC/ALARM	8543880000	H.4
WAZ5 DC/ALARM	8543880000	H.11
WAZ5 DC/ALARM	8543880000	X
WAZ6 TTA	8939680000	H.4
WAZ6 TTA	8939680000	H.6
WAZ6 TTA	8939680000	X
WAZ6 TTA EX	8964320000	H.4
WAZ6 TTA EX	8964320000	H.7
WAZ6 TTA EX	8964320000	X
WDS2 RS232/RS485/422	8615700000	H.4
WDS2 RS232/RS485/422	8615700000	H.9
WDS2 RS232/RS485/422	8615700000	X
WDS2 RS232/TTY	8615690000	H.4
WDS2 RS232/TTY	8615690000	H.10
WDS2 RS232/TTY	8615690000	X
WS 10/5 MC NE WS	1635000000	K.12
WS 10/6 MC NE WS	1828450000	K.12
WS 15/5 MC NE WS	1609880000	K.12

## Z

Z0V 2.5N/2 BL	1717990000	K.12
Z0V 2.5N/2 GE	1693800000	K.12
Z0V 2.5N/2 RT	1717900000	K.12
Z0V 2.5N/2 SW	1718080000	K.12
Z0V 4N/10 GE	1758260000	K.12
Z0V 4N/2 GE	1758250000	K.12
Z0V 4N/3 GE	1762630000	K.12
Z0V 4N/4 GE	1762620000	K.12

Order No.	Type	Page
-----------	------	------

## 0230000000

0236510000	TS 35X15/LL 1M/ST/ZN	K.7
------------	----------------------	-----

## 0510000000

0514510000	TS 35X7.5/LL 1M/ST/ZN	K.7
------------	-----------------------	-----

## 1060000000

1067250000	ACT20P-BRIDGE-S	D.4
1067250000	ACT20P-BRIDGE-S	D.22
1067250000	ACT20P-BRIDGE-S	VI

## 1080000000

1082540000	ESG 6.6/20 BHZ 5.00/04	K.10
1086040000	BHZ 5.00/02/90LH BK/BK PRT 41	K.10
1086130000	BHZ 5.00/04/90LH BK/BK PRT 11	K.10
1086140000	BHZ 5.00/04/90LH BK/BK PRT 21	K.10
1086150000	BHZ 5.00/04/90LH BK/BK PRT 31	K.10
1086160000	BHZ 5.00/04/90LH BK/BK PRT 41	K.10
1086170000	BHZ 5.00/04/90LH BK/BK PRT 51	K.10
1086180000	BHZ 5.00/04/90LH BK/BK PRT 61	K.10
1086190000	BHZ 5.00/04/90LH BK/BK PRT 15	K.10
1086200000	BHZ 5.00/04/90LH BK/BK PRT 25	K.10
1086210000	BHZ 5.00/04/90LH BK/BK PRT 35	K.10
1086220000	BHZ 5.00/04/90LH BK/BK PRT 45	K.10
1086230000	BHZ 5.00/04/90LH BK/BK PRT 55	K.10
1086240000	BHZ 5.00/04/90LH BK/BK PRT 65	K.10
1086250000	BHZ 5.00/02/90LH BK/BL PRT 11	K.10
1086260000	BHZ 5.00/02/90LH BK/BL PRT 21	K.10
1086370000	BHZ 5.00/04/90LH BK/BL PRT 11	K.10
1086380000	BHZ 5.00/04/90LH BK/BL PRT 21	K.10
1086390000	BHZ 5.00/04/90LH BK/BL PRT 31	K.10
1086400000	BHZ 5.00/04/90LH BK/BL PRT 41	K.10
1086410000	BHZ 5.00/04/90LH BK/BL PRT 51	K.10
1086420000	BHZ 5.00/04/90LH BK/BL PRT 61	K.10
1086430000	BHZ 5.00/04/90LH BK/BL PRT 15	K.10
1086440000	BHZ 5.00/04/90LH BK/BL PRT 25	K.10
1086450000	BHZ 5.00/04/90LH BK/BL PRT 35	K.10
1086460000	BHZ 5.00/04/90LH BK/BL PRT 45	K.10
1086470000	BHZ 5.00/04/90LH BK/BL PRT 55	K.10
1086480000	BHZ 5.00/04/90LH BK/BL PRT 65	K.10

## 1160000000

1160640000	ACT20X-CJC-HTI-S PRT 11	K.10
1160650000	ACT20X-CJC-HTI-S PRT 21	K.10

## 1170000000

1175980000	ACT20M-CI-CD-S	E.4
1175980000	ACT20M-CI-CD-S	E.6
1175980000	ACT20M-CI-CD-S	VIII
1175990000	ACT20M-CI-2CD-S	E.4
1175990000	ACT20M-CI-2CD-S	E.12
1175990000	ACT20M-CI-2CD-S	VIII
1176000000	ACT20M-AI-AD-S	E.4
1176000000	ACT20M-AI-AD-S	E.7
1176000000	ACT20M-AI-AD-S	VIII
1176010000	ACT20M-AI-AD-E-S	E.4
1176010000	ACT20M-AI-AD-E-S	E.8
1176010000	ACT20M-AI-AD-E-S	VIII
1176020000	ACT20M-AI-2AO-S	E.4
1176020000	ACT20M-AI-2AO-S	E.13
1176020000	ACT20M-AI-2AO-S	VIII
1176030000	ACT20M-UI-AG-S	E.4
1176030000	ACT20M-UI-AG-S	E.21
1176030000	ACT20M-UI-AG-S	VIII
1176040000	ACT20M-CI-CD-OLP-S	E.4
1176040000	ACT20M-CI-CD-OLP-S	E.11
1176040000	ACT20M-CI-CD-OLP-S	VIII
1176050000	ACT20M-2CI-2CD-OLP-S	E.4
1176050000	ACT20M-2CI-2CD-OLP-S	E.11
1176050000	ACT20M-2CI-2CD-OLP-S	VIII
1176070000	ACT20M-CI-CD-ILP-S	E.4
1176070000	ACT20M-CI-CD-ILP-S	E.10
1176070000	ACT20M-CI-CD-ILP-S	VIII
1176080000	ACT20M-2CI-2CD-ILP-S	E.4
1176080000	ACT20M-2CI-2CD-ILP-S	E.10
1176080000	ACT20M-2CI-2CD-ILP-S	VIII

## 1190000000

1193160000	CH20M BUS-AP LI TS 35X7.5 & 15	K.7
1193170000	CH20M BUS-AP RE TS 35X7.5 & 15	K.7

## 1230000000

1238910000	ACT20P-UI-2RCD-AC-S	D.4
1238910000	ACT20P-UI-2RCD-AC-S	D.17
1238910000	ACT20P-UI-2RCD-AC-S	VI

## 1240000000

1248150000	CH20M BUS-PROFIL TS 35X7.5/250	K.7
1248160000	CH20M BUS-PROFIL TS 35X7.5/500	K.7
1248170000	CH20M BUS-PROFIL TS 35X7.5/750	K.7

Order No.	Type	Page
-----------	------	------

1248180000	CH20M BUS-PROFIL TS 35X15/250	K.7
1248190000	CH20M BUS-PROFIL TS 35X15/500	K.7
1248210000	CH20M BUS-PROFIL TS 35X15/750	K.7
1248220000	CH20M BUS 4.50/05 AU/250	K.7
1248230000	CH20M BUS 4.50/05 AU/500	K.7
1248240000	CH20M BUS 4.50/05 AU/750	K.7
1248250000	CH20M BUS-ADP TS 35/250	K.7
1248260000	CH20M BUS-ADP TS 35/500	K.7
1248270000	CH20M BUS-ADP TS 35/750	K.7

## 1280000000

1282490000	ACT20-FEED-IN-BASICS	K.2
1282490000	ACT20-FEED-IN-BASICS	K.9
1282490000	ACT20-FEED-IN-BASICS	X

## 1310000000

1318220000	ACT20X-HUI-5AO-LP-S	C.4
1318220000	ACT20X-HUI-5AO-LP-S	C.23
1318220000	ACT20X-HUI-5AO-LP-S	IV

## 1330000000

1335140000	SET CH20M BUS 250MM TS 35X7.5	K.7
1335150000	SET CH20M BUS 250MM TS 35X15	K.7

## 1370000000

1375450000	ACT20M-BAI-AD-S	E.4
1375450000	ACT20M-BAI-AD-S	E.9
1375450000	ACT20M-BAI-AD-S	E.4
1375470000	ACT20M-BAI-2AO-S	VIII
1375470000	ACT20M-BAI-2AO-S	E.14
1375470000	ACT20M-BAI-2AO-S	IV
1375480000	ACT20M-TCI-AD-S	E.4
1375480000	ACT20M-TCI-AD-S	E.19
1375480000	ACT20M-TCI-AD-S	VIII
1375500000	ACT20M-TCI-AD-E-S	E.4
1375500000	ACT20M-TCI-AD-E-S	E.20
1375500000	ACT20M-TCI-AD-E-S	VIII
1375510000	ACT20M-RTI-AD-S	E.4
1375510000	ACT20M-RTI-AD-S	E.17
1375510000	ACT20M-RTI-AD-S	VIII
1375520000	ACT20M-RTI-AD-E-S	E.4
1375520000	ACT20M-RTI-AD-E-S	E.18
1375520000	ACT20M-RTI-AD-E-S	VIII

## 1430000000

1435590000	ACT20M-RTCI-CO-OLP-S	E.4
1435590000	ACT20M-RTCI-CO-OLP-S	E.15
1435590000	ACT20M-RTCI-CO-OLP-S	VIII
1435610000	ACT20M-RTI-CO-OLP-S	E.4
1435610000	ACT20M-RTI-CO-OLP-S	E.16
1435610000	ACT20M-RTI-CO-OLP-S	VIII
1439640000	PORTACAL 1000EU	K.15

## 1450000000

1453210000	ACT20P-UI-AO-DO-LP-S	D.4
1453210000	ACT20P-UI-AO-DO-LP-S	D.24
1453210000	ACT20P-UI-AO-DO-LP-S	VI

## 1460000000

1466380000	SW Weidmüller DTW-Library Setup	J.4
------------	---------------------------------	-----

## 1470000000

1474720000	ACT20P-AI-AO-DC-S	D.4
1474720000	ACT20P-AI-AO-DC-S	D.25
1474720000	ACT20P-AI-AO-DC-S	VI

## 1480000000

1481960000	ACT20P-PRO DCDC II-P	D.4
1481960000	ACT20P-PRO DCDC II-P	D.23
1481960000	ACT20P-PRO DCDC II-P	VI
1481970000	ACT20P-PRO DCDC II-S	D.4
1481970000	ACT20P-PRO DCDC II-S	D.23
1481970000	ACT20P-PRO DCDC II-S	VI

## 1510000000

1510240000	ACT20C-CMT-10-AO-RC-S	B.4
1510240000	ACT20C-CMT-10-AO-RC-S	B.7
1510240000	ACT20C-CMT-10-AO-RC-S	IV
1510280000	ACT20P-CMT-60-RC-P	D.4
1510280000	ACT20P-CMT-60-RC-P	D.21
1510280000	ACT20P-CMT-60-RC-P	VI
1510290000	ACT20P-CMT-60-AO-RC-P	D.4
1510290000	ACT20P-CMT-60-AO-RC-P	D.21
1510290000	ACT20P-CMT-60-AO-RC-P	VI
1510320000	ACT20P-CMT-30-AO-RC-P	D.4
1510320000	ACT20P-CMT-30-AO-RC-P	D.21
1510320000	ACT20P-CMT-30-AO-RC-P	VI
1510330000	ACT20P-CMT-10-AO-RC-P	D.4
1510330000	ACT20P-CMT-10-AO-RC-P	D.21

Order No.	Type	Page
-----------	------	------

1510330000	ACT20P-CMT-10-AO-RC-P	VI
1510340000	ACT20C-LBT-10	B.4
1510340000	ACT20C-LBT-10	B.9
1510340000	ACT20C-LBT-10	IV
1510370000	ACT20C-GTW-100-MTCP-S	B.4
1510370000	ACT20C-GTW-100-MTCP-S	B.6
1510370000	ACT20C-GTW-100-MTCP-S	IV
1510390000	ACT20P-CMT-60-RC-S	D.4
1510390000	ACT20P-CMT-60-RC-S	D.21
1510390000	ACT20P-CMT-60-RC-S	VI
1510420000	ACT20C-CMT-60-AO-RC-S	B.4
1510420000	ACT20C-CMT-60-AO-RC-S	B.7
1510420000	ACT20C-CMT-60-AO-RC-S	IV
1510440000	ACT20P-CMT-60-AO-RC-S	D.4
1510440000	ACT20P-CMT-60-AO-RC-S	D.21
1510440000	ACT20P-CMT-60-AO-RC-S	VI
1510470000	ACT20P-CMT-10-AO-RC-S	D.4
1510470000	ACT20P-CMT-10-AO-RC-S	D.21
1510470000	ACT20P-CMT-10-AO-RC-S	VI
1510540000	ACT20P-CMT-30-AO-RC-S	D.4
1510540000	ACT20P-CMT-30-AO-RC-S	D.21
1510540000	ACT20P-CMT-30-AO-RC-S	VI

## 1520000000

1526460000	BLZ 5.08/02/180 SN OR BX	K.13
------------	--------------------------	------

## 1540000000

1540010000	ACT20P-CI-VO-S	D.4
1540010000	ACT20P-CI-VO-S	D.9
1540010000	ACT20P-CI-VO-S	VI

## 1600000000

1609880000	WS 15/5 MC NE WS	K.12
------------	------------------	------

## 1630000000

1635000000	WS 10/5 MC NE WS	K.12
------------	------------------	------

## 1690000000

1693800000	ZQV 2.5N/2 GE	K.12
------------	---------------	------

## 1710000000

1717900000	ZQV 2.5N/2 RT	K.12
1717990000	ZQV 2.5N/2 BL	K.12
1718080000	ZQV 2.5N/2 SW	K.12

## 1750000000

1758250000	ZQV 4N/2 GE	K.12
1758260000	ZQV 4N/10 GE	K.12

## 1760000000

1762620000	ZQV 4N/4 GE	K.12
1762630000	ZQV 4N/3 GE	K.12

## 1820000000

1828450000	WS 10/6 MC NE WS	K.12
------------	------------------	------

## 1870000000

1877680000	MF 5/7.5 MC NE WS	K.11
------------	-------------------	------



Order No.	Type	Page
2517450000	PICOPAK-CI-CO-LPS	G.6
2517450000	PICOPAK-CI-CO-LPS	VIII

## 2740000000

2740080000	IT20-ATDIORQ-NB-P	A.4
------------	-------------------	-----

## 7760000000

7760054114	ACT20P-CI-CO-S	D.4
7760054114	ACT20P-CI-CO-S	D.7
7760054114	ACT20P-CI-CO-S	VI
7760054115	ACT20P-CI-2CO-S	D.4
7760054115	ACT20P-CI-2CO-S	D.14
7760054115	ACT20P-CI-2CO-S	VI
7760054117	ACT20P-2CI-2CO-12-S	D.4
7760054117	ACT20P-2CI-2CO-12-S	D.8
7760054117	ACT20P-2CI-2CO-12-S	VI
7760054118	ACT20P-CI1-CO-OLP-S	D.4
7760054118	ACT20P-CI1-CO-OLP-S	D.12
7760054118	ACT20P-CI1-CO-OLP-S	VI
7760054119	ACT20P-CI2-CO-OLP-S	D.4
7760054119	ACT20P-CI2-CO-OLP-S	D.12
7760054119	ACT20P-CI2-CO-OLP-S	VI
7760054120	ACT20P-VI1-CO-OLP-S	D.4
7760054120	ACT20P-VI1-CO-OLP-S	D.12
7760054120	ACT20P-VI1-CO-OLP-S	VI
7760054121	ACT20P-VI-CO-OLP-S	D.4
7760054121	ACT20P-VI-CO-OLP-S	D.12
7760054121	ACT20P-VI-CO-OLP-S	VI
7760054122	ACT20P-CI-2CO-OLP-S	D.4
7760054122	ACT20P-CI-2CO-OLP-S	D.13
7760054122	ACT20P-CI-2CO-OLP-S	VI
7760054123	ACT20P-CI-CO-ILP-S	D.4
7760054123	ACT20P-CI-CO-ILP-S	D.11
7760054123	ACT20P-CI-CO-ILP-S	VI
7760054124	ACT20P-2CI-2CO-ILP-S	D.4
7760054124	ACT20P-2CI-2CO-ILP-S	D.11
7760054124	ACT20P-2CI-2CO-ILP-S	VI
7760054164	ACT20P-VMR-1PH-H-S	D.4
7760054164	ACT20P-VMR-1PH-H-S	D.18
7760054164	ACT20P-VMR-1PH-H-S	VI
7760054165	ACT20P-VMR-3PH-ILP-H-S	D.4
7760054165	ACT20P-VMR-3PH-ILP-H-S	D.19
7760054165	ACT20P-VMR-3PH-ILP-H-S	VI
7760054305	ACT20P-TMR-RTI-S	D.4
7760054305	ACT20P-TMR-RTI-S	D.15
7760054305	ACT20P-TMR-RTI-S	VI
7760054306	ACT20P-VM-AD-S	D.4
7760054306	ACT20P-VM-AD-S	D.10
7760054306	ACT20P-VM-AD-S	VI

## 7940000000

7940010163	LPD350 4-20MA/0-100.0	I.2
7940010163	LPD350 4-20MA/0-100.0	I.10
7940010163	LPD350 4-20MA/0-100.0	X
7940010185	DI350 4-20MA/0-100.0	I.2
7940010185	DI350 4-20MA/0-100.0	I.9
7940010185	DI350 4-20MA/0-100.0	X
7940010202	P275	K.17
7940010236	LPD450F 4-20MA	I.2
7940010236	LPD450F 4-20MA	I.11
7940010236	LPD450F 4-20MA	X
7940010243	PTX800A 4-20MA	I.2
7940010243	PTX800A 4-20MA	I.5
7940010243	PTX800A 4-20MA	X
7940011133	PTX800D	I.2
7940011133	PTX800D	I.4
7940011133	PTX800D	X
7940011570	DI350 0-10V/0-100.0	I.2
7940011570	DI350 0-10V/0-100.0	I.9
7940011570	DI350 0-10V/0-100.0	X
7940011979	PMX400HZX RO/AO	I.2
7940011979	PMX400HZX RO/AO	I.8
7940011979	PMX400HZX RO/AO	X
7940012323	PTX800D RO/AO	I.2
7940012323	PTX800D RO/AO	I.4
7940012323	PTX800D RO/AO	X
7940014374	PTX800A 4-20MA/RO/AO	I.2
7940014374	PTX800A 4-20MA/RO/AO	I.5
7940014374	PTX800A 4-20MA/RO/AO	X
7940015595	PMX400HZX	I.2
7940015595	PMX400HZX	I.8
7940015595	PMX400HZX	X
7940018956	PMX420	I.2
7940018956	PMX420	I.7
7940018956	PMX420	X
7940018957	PMX420PLUS	I.2
7940018957	PMX420PLUS	I.6
7940018957	PMX420PLUS	X
7940045760	ACT20P-UI-2RCD-DC-S	D.4
7940045760	ACT20P-UI-2RCD-DC-S	D.17
7940045760	ACT20P-UI-2RCD-DC-S	VI

## 8220000000

8227350000	MCZ SC 0-20MA	F.4
8227350000	MCZ SC 0-20MA	F.7

Order No.	Type	Page
8227350000	MCZ SC 0-20MA	VIII

## 8260000000

8260280000	MCZ SC 0-10V	F.4
8260280000	MCZ SC 0-10V	F.7
8260280000	MCZ SC 0-10V	VIII

## 8380000000

8389030000	AP MCZ1.5 1674	K.12
------------	----------------	------

## 8410000000

8411190000	MCZ CCC 0-20MA/0-20MA	F.4
8411190000	MCZ CCC 0-20MA/0-20MA	F.8
8411190000	MCZ CCC 0-20MA/0-20MA	VIII

## 8420000000

8425720000	MCZ PT100/3 CLP 0...100C	F.4
8425720000	MCZ PT100/3 CLP 0...100C	F.9
8425720000	MCZ PT100/3 CLP 0...100C	VIII

## 8460000000

8461470000	MCZ VFC 0-10V	F.4
8461470000	MCZ VFC 0-10V	F.6
8461470000	MCZ VFC 0-10V	VIII
8461480000	MCZ CFC 0-20MA	F.4
8461480000	MCZ CFC 0-20MA	F.6
8461480000	MCZ CFC 0-20MA	VIII
8461490000	MCZ CFC 4-20MA	F.4
8461490000	MCZ CFC 4-20MA	F.6
8461490000	MCZ CFC 4-20MA	VIII

## 8470000000

8473000000	MCZ PT100/3 CLP -50C...+150C	F.4
8473000000	MCZ PT100/3 CLP -50C...+150C	F.9
8473000000	MCZ PT100/3 CLP -50C...+150C	VIII
8473010000	MCZ PT100/3 CLP 0...200C	F.4
8473010000	MCZ PT100/3 CLP 0...200C	F.9
8473010000	MCZ PT100/3 CLP 0...200C	VIII
8473020000	MCZ PT100/3 CLP 0...300C	F.4
8473020000	MCZ PT100/3 CLP 0...300C	F.9
8473020000	MCZ PT100/3 CLP 0...300C	VIII

## 8480000000

8483680000	MCZ PT100/3 CLP 0...120C	F.4
8483680000	MCZ PT100/3 CLP 0...120C	F.9
8483680000	MCZ PT100/3 CLP 0...120C	VIII

## 8520000000

8528650000	WAS1 CMA LP 1/5/10A AC	H.4
8528650000	WAS1 CMA LP 1/5/10A AC	H.8
8528650000	WAS1 CMA LP 1/5/10A AC	X
8528660000	WAZ1 CMA LP 1/5/10A AC	H.4
8528660000	WAZ1 CMA LP 1/5/10A AC	H.8
8528660000	WAZ1 CMA LP 1/5/10A AC	X

## 8540000000

8543820000	WAS5 DC/ALARM	H.4
8543820000	WAS5 DC/ALARM	H.11
8543820000	WAS5 DC/ALARM	X
8543880000	WAZ5 DC/ALARM	H.4
8543880000	WAZ5 DC/ALARM	H.11
8543880000	WAZ5 DC/ALARM	X

## 8600000000

8604420000	MCZ PT100/3 CLP 0...150C	F.4
8604420000	MCZ PT100/3 CLP 0...150C	F.9
8604420000	MCZ PT100/3 CLP 0...150C	VIII
8604430000	MCZ PT100/3 CLP 40C...100C	F.4
8604430000	MCZ PT100/3 CLP 40C...100C	F.9
8604430000	MCZ PT100/3 CLP 40C...100C	VIII

## 8610000000

8615690000	WDS2 RS232/TTY	H.4
8615690000	WDS2 RS232/TTY	H.10
8615690000	WDS2 RS232/TTY	X
8615700000	WDS2 RS232/RS485/422	H.4
8615700000	WDS2 RS232/RS485/422	H.9
8615700000	WDS2 RS232/RS485/422	X

## 8740000000

8742610000	PAS CMR 0.5...2.5 A DC	H.4
8742610000	PAS CMR 0.5...2.5 A DC	H.12
8742610000	PAS CMR 0.5...2.5 A DC	X
8742620000	PAS CMR 2.0...5.0 A DC	H.4
8742620000	PAS CMR 2.0...5.0 A DC	H.12
8742620000	PAS CMR 2.0...5.0 A DC	X
8742630000	PAS CMR 4.5...10 A DC	H.4

Order No.	Type	Page
8742630000	PAS CMR 4.5...10 A DC	H.13
8742630000	PAS CMR 4.5...10 A DC	X

## 8930000000

8939670000	WAS6 TTA	H.4
8939670000	WAS6 TTA	H.6
8939670000	WAS6 TTA	X
8939680000	WAZ6 TTA	H.4
8939680000	WAZ6 TTA	H.6
8939680000	WAZ6 TTA	X

## 8960000000

8964310000	WAS6 TTA EX	H.4
8964310000	WAS6 TTA EX	H.7
8964310000	WAS6 TTA EX	X
8964320000	WAZ6 TTA EX	H.4
8964320000	WAZ6 TTA EX	H.7
8964320000	WAZ6 TTA EX	X
8965340000	ACT20X-HDI-SDD-RNO-S	C.4
8965340000	ACT20X-HDI-SDD-RNO-S	C.13
8965340000	ACT20X-HDI-SDD-RNO-S	IV
8965350000	ACT20X-HDI-SDD-RNC-S	C.4
8965350000	ACT20X-HDI-SDD-RNC-S	C.13
8965350000	ACT20X-HDI-SDD-RNC-S	IV
8965360000	ACT20X-HDI-SDD-S	C.4
8965360000	ACT20X-HDI-SDD-S	C.15
8965360000	ACT20X-HDI-SDD-S	IV
8965370000	ACT20X-2HDI-2SDD-RNO-S	C.4
8965370000	ACT20X-2HDI-2SDD-RNO-S	C.13
8965370000	ACT20X-2HDI-2SDD-RNO-S	IV
8965380000	ACT20X-2HDI-2SDD-RNC-S	C.4
8965380000	ACT20X-2HDI-2SDD-RNC-S	C.13
8965380000	ACT20X-2HDI-2SDD-RNC-S	IV
8965390000	ACT20X-2HDI-2SDD-S	C.4
8965390000	ACT20X-2HDI-2SDD-S	C.15
8965390000	ACT20X-2HDI-2SDD-S	IV
8965400000	ACT20X-SDI-HDD-L-S	C.4
8965400000	ACT20X-SDI-HDD-L-S	C.17
8965400000	ACT20X-SDI-HDD-L-S	IV
8965410000	ACT20X-SDI-HDD-H-S	C.4
8965410000	ACT20X-SDI-HDD-H-S	C.19
8965410000	ACT20X-SDI-HDD-H-S	IV
8965420000	ACT20X-2SDI-2HDD-S	C.4
8965420000	ACT20X-2SDI-2HDD-S	C.17
8965420000	ACT20X-2SDI-2HDD-S	IV
8965430000	ACT20X-HAI-SAO-S	C.4
8965430000	ACT20X-HAI-SAO-S	C.7
8965430000	ACT20X-HAI-SAO-S	IV
8965440000	ACT20X-2HAI-2SAO-S	C.4
8965440000	ACT20X-2HAI-2SAO-S	C.7
8965440000	ACT20X-2HAI-2SAO-S	IV
8965450000	ACT20X-SAI-HAO-S	C.4
8965450000	ACT20X-SAI-HAO-S	C.9
8965450000	ACT20X-SAI-HAO-S	IV
8965460000	ACT20X-2SAI-2HAI-S	C.4
8965460000	ACT20X-2SAI-2HAI-S	C.9
8965460000	ACT20X-2SAI-2HAI-S	IV
8965470000	ACT20X-HTI-SAO-S	C.4
8965470000	ACT20X-HTI-SAO-S	C.11
8965470000	ACT20X-HTI-SAO-S	IV
8965480000	ACT20X-2HTI-2SAO-S	C.4
8965480000	ACT20X-2HTI-2SAO-S	C.11
8965480000	ACT20X-2HTI-2SAO-S	IV
8965490000	ACT20X-HUI-SAO-S	C.4
8965490000	ACT20X-HUI-SAO-S	C.21
8965490000	ACT20X-HUI-SAO-S	IV
8965500000	ACT20-FEED-IN-PRO-S	K.2
89655000		

# Addresses worldwide

Let's connect.

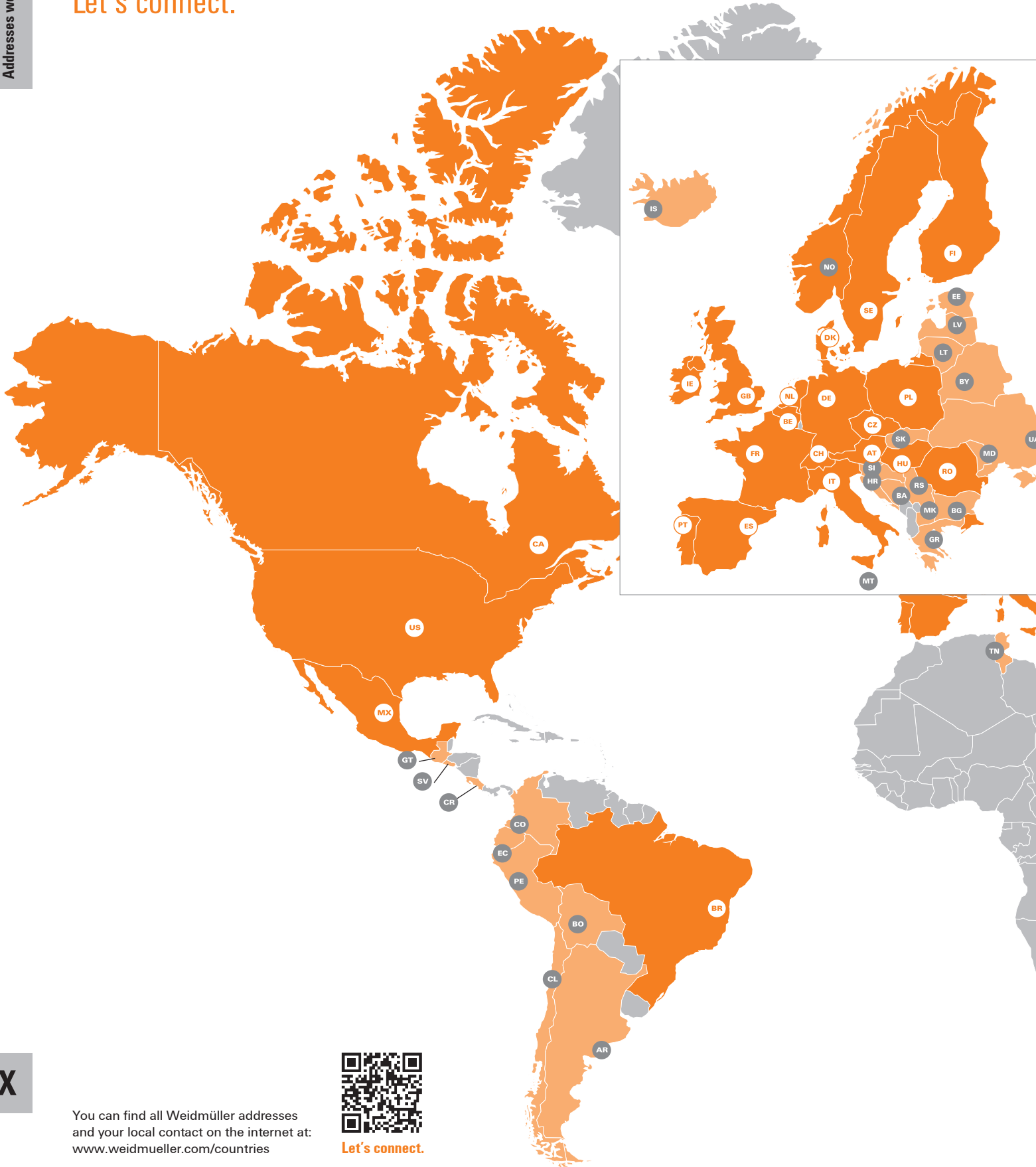

X

You can find all Weidmüller addresses and your local contact on the internet at: [www.weidmueller.com/countries](http://www.weidmueller.com/countries)



Let's connect.

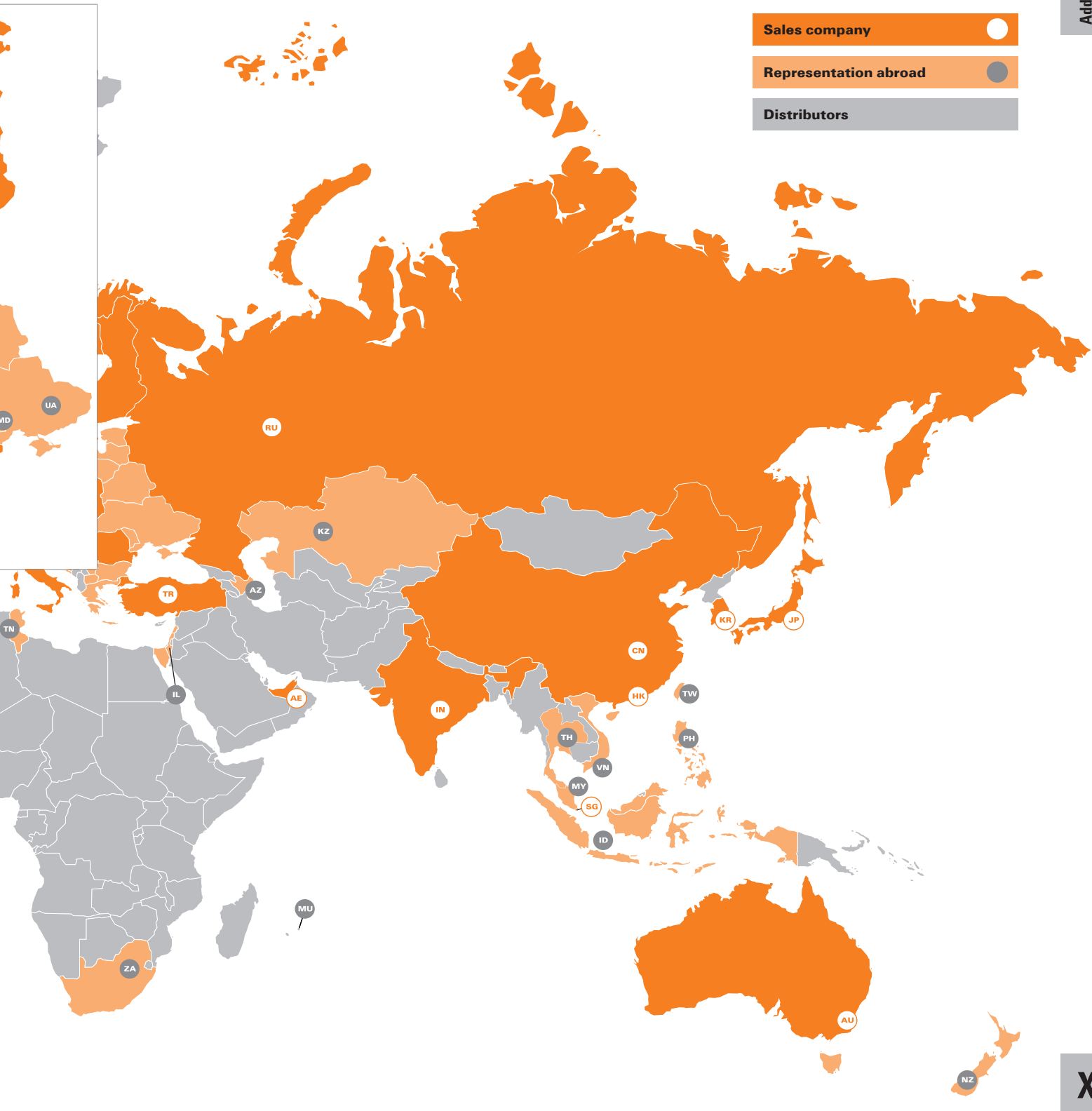

We cannot guarantee that there are no mistakes in the publications or software provided by us to the customer for the purpose of making orders. We try our best to quickly correct errors in our printed media.

**X**

All orders are based on our general terms of delivery, which can be reviewed on the websites of our group companies where you place your order. On demand we can also send the general terms of delivery to you.



## Weidmüller – Your partner in Industrial Connectivity

As experienced experts we support our customers and partners around the world with products, solutions and services in the industrial environment of power, signal and data. We are at home in their industries and markets and know the technological challenges of tomorrow. We are therefore continuously developing innovative, sustainable and useful solutions for their individual needs. Together we set standards in Industrial Connectivity.

Weidmüller Interface GmbH & Co. KG  
Klingenbergstraße 26  
32758 Detmold, Germany  
T +49 5231 14-0  
F +49 5231 14-292083  
[www.weidmueller.com](http://www.weidmueller.com)

Personal support can  
be found on our website:  
[www.weidmueller.com/contact](http://www.weidmueller.com/contact)

Made in Germany



Order number: 2729490000/06/2020/SMM