

# Command and signalling devices

Product information



# Introduction



Heinz and Philip Schmersal, managing directors of the Schmersal Group

## **Safety in system – Protection for man and machine**

Often, it is unavoidable that people have to intervene with the workings of a machine. When this is done the safety of the operator is imperative. This demands the responsibility of the machine operator, which is also required by the world's standards and guidelines for machine safety.

The Schmersal Group has concentrated for many years on safety at work with our products and solutions; today we can offer the industry the world's largest range of safety switchgear and systems for the protection of man and machine.

Under the guiding principle „Safety with system – protection for man and machine“ we develop and produce products that carry the system concept and can be optimally integrated into the work processes. Because we are convinced that safety does not contradict higher productivity.

In our fields of activity we have a leading position due to our expertise, our innovative power and our comprehensive range of products. With this we follow a central theme: Together with you, we want to make the world safer. Talk to us – we look forward to working with you.

# Content

■ Schmersal _____	Page 4
■ Command and signalling devices _____	Page 8
E program _____	Page 10
N program _____	Page 26
R program _____	Page 42
A program _____	Page 58
Contact and lighting elements _____	Page 72
Accessories _____	Page 86
Enclosures for surface mounting _____	Page 90
■ Control panels _____	Page 94
■ Two-hand control panels _____	Page 102
■ Maintained joystick switches and spring-return joystick switches _____	Page 110
■ Enabling switches _____	Page 118

# History

## Milestones 1945 – 2016



Schmersal Brazil 1974



Schmersal China 2013



Startup of the new central warehouse in 2013

1945

The brothers Kurt Andreas Schmersal and Ernst Schmersal **form the company** in Wuppertal.

1950s

The **product portfolio** is continuously expanded. Many switchgears are used in safety related applications such as in explosive areas.

1970s

Schmersal is one of the first companies to begin development and production of **electronic proximity switches**.

1974

**ACE Schmersal** is formed in Boituva, Brazil.

1982

**Generational change:** Heinz and Stefan Schmersal take over the company from their fathers.

1997

**ELAN Schaltelemente GmbH & Co. KG** based in Wettenberg is acquired.

1999

The production facility **Schmersal Industrial Switchgear Co. Ltd** (SISS) is formed in Shanghai, China.

2007

Philip Schmersal joins the **third generation of the** Schmersal Group.

2008

In October 2008 the Schmersal Group takes over **Safety Control GmbH** and its affiliate Protec GmbH in Mühldorf/Inn.

2013

**Böhnke + Partner Steuerungssysteme GmbH** is acquired.  
**Schmersal India** becomes a production facility.  
Startup of the new **European central warehouse** in Wuppertal.

2015

In 2015, the Schmersal Group celebrated its **70th anniversary**.  
Michael Mandel is appointed **Managing Director of K.A. Schmersal GmbH & Co. KG** in April (Wuppertal/Wettenberg).  
Schmersal Böhnke+Partner move into a **new production and office building** in Bergisch Gladbach.

2016

The Schmersal Group is establishing its own business area for services under the name **tec.nicum**.

## Schmersal worldwide

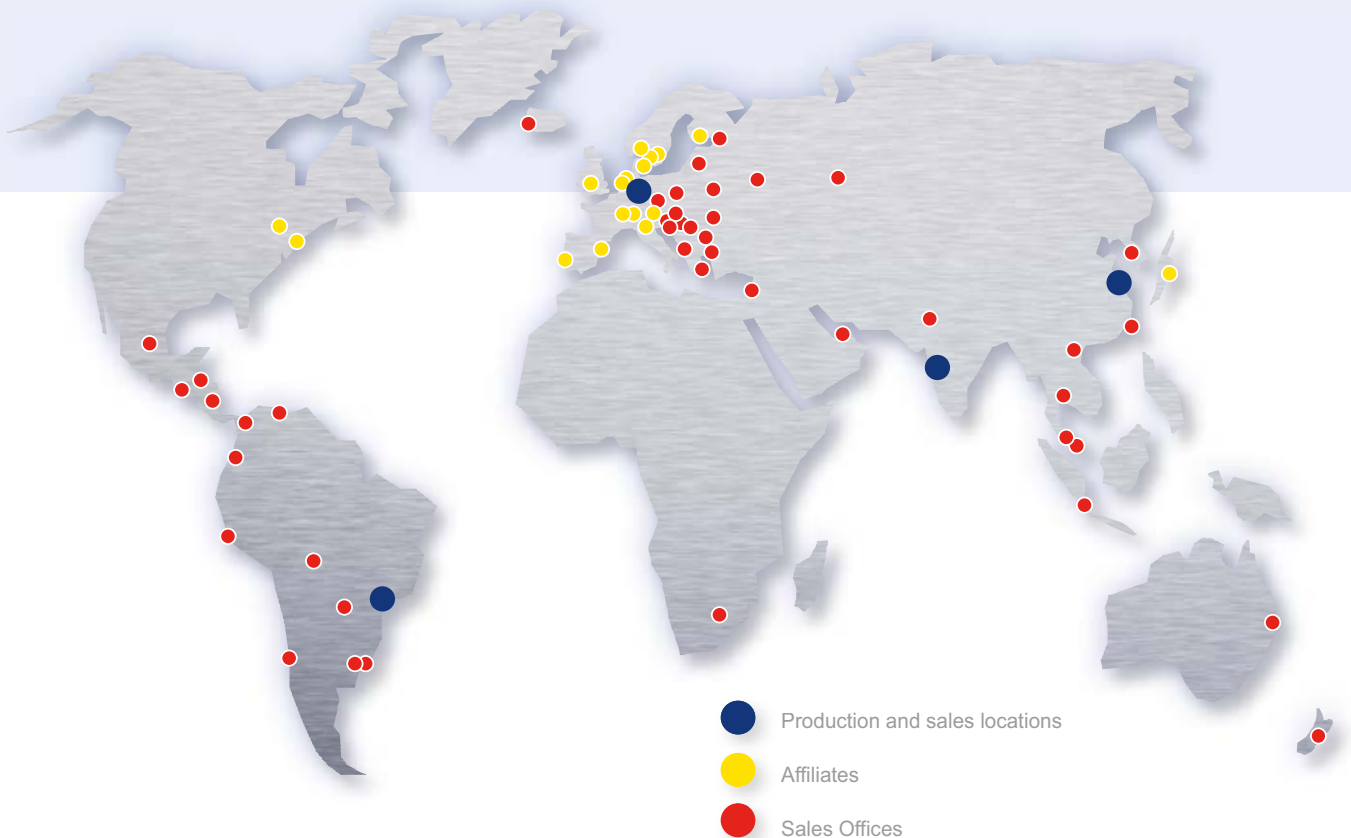

With its own affiliates in around 20 countries and capable sales and service partners in 30 more countries, the Schmersal Group has operations worldwide.

We started quite early with the internationalisation of sales, consultancy and production. This is also one of the reasons that we are a favoured global partner for machinery and plant construction and also an approved partner for many medium sized engineering companies with local presence. Wherever there are machines that work with Schmersal safety switches, the nearest branch or representative is not far away.

- |  |  |   |
|--|--|---|
| <ul style="list-style-type: none"> <li>■ Germany, Wuppertal</li> <li>■ Germany, Wetzlar</li> <li>■ Germany, Mühldorf</li> <li>■ Germany, Bergisch Gladbach</li> <li>■ Brazil, Boituva</li> <li>■ China, Shanghai</li> <li>■ India, Pune</li> </ul>   | <ul style="list-style-type: none"> <li>■ Argentina, Buenos Aires</li> <li>■ Australia, Brisbane</li> <li>■ Baltic States, Kaunas</li> <li>■ Bolivia, Santa Cruz de la Sierra</li> <li>■ Bulgaria, Ruse City</li> <li>■ Chile, Santiago</li> <li>■ Ecuador, Quito</li> <li>■ Greece, Athens</li> <li>■ Guatemala, Guatemala-City</li> <li>■ Indonesia, Jakarta</li> <li>■ Iceland, Reykjavik</li> <li>■ Israel, Petach Tikva</li> <li>■ Kazakhstan, Ayrar</li> <li>■ Colombia, Medellín</li> <li>■ South Korea, Seoul</li> <li>■ Croatia, Zagreb</li> <li>■ Malaysia, Rawang</li> <li>■ Macedonia, Skopje</li> <li>■ Mexico, Mexico City</li> <li>■ New Zealand, Christchurch</li> <li>■ Pakistan, Islamabad</li> </ul> | <ul style="list-style-type: none"> <li>■ Paraguay, Minga Guazú</li> <li>■ Peru, Lima</li> <li>■ Poland, Warsaw</li> <li>■ Romania, Sibiu</li> <li>■ Russia, Moscow</li> <li>■ Serbia, Belgrade</li> <li>■ Singapore, Singapore</li> <li>■ Slovenia, Ljubljana</li> <li>■ South Africa, Johannesburg</li> <li>■ Taiwan, Taichung</li> <li>■ Thailand, Bangkok</li> <li>■ Czech Republic, Prague</li> <li>■ Turkey, Istanbul</li> <li>■ Ukraine, Kiev</li> <li>■ Hungary, Győr</li> <li>■ Uruguay, Montevideo</li> <li>■ United Arab Emirates, Sharjah</li> <li>■ Venezuela, Caracas</li> <li>■ Vietnam, Hanoi</li> <li>■ Belarus, Minsk</li> </ul> |
| <ul style="list-style-type: none"> <li>■ Belgium, Aarschot</li> <li>■ Denmark, Ballerup</li> <li>■ Finland, Helsinki</li> <li>■ France, Seyssins</li> <li>■ United Kingdom, Malvern, Worcestershire</li> <li>■ Italy, Borgosatollo</li> <li>■ Japan, Tokyo</li> <li>■ Canada, Brampton</li> <li>■ Netherlands, Harderwijk</li> <li>■ Norway, Oslo</li> <li>■ Austria, Vienna</li> <li>■ Portugal, Póvoa de Sta. Iria</li> <li>■ Sweden, Mölnlycke</li> <li>■ Switzerland, Arni</li> <li>■ Spain, Barcelona</li> <li>■ USA, Tarrytown NY</li> </ul> |  |   |

# Schmersal Worldwide

## Offices in Germany

### Wuppertal



#### K.A. Schmersal GmbH & Co. KG

- Founded in 1945
- Around 700 employees

#### Focal points

- Headquarters of the Schmersal Group
- Development and manufacture of switchgears and switching systems for safety, automation and lift engineering
- Accredited test laboratory
- Central research and development
- Logistics centre for European markets

### Wettenberg



#### K.A. Schmersal GmbH & Co. KG

- Founded in 1952 (1997)
- Around 180 employees

#### Focal points

- Development and manufacture of switchgears for operation and monitoring, safety-related relay modules and controls as well as switchgears for explosion protection

### Mühdorf / Inn



#### Safety Control GmbH

- Founded in 1994 (2008)
- Around 30 employees

#### Focal points

- Development and manufacture of optical electronic components for safety and automation engineering

### Bergisch Gladbach



#### Böhnke + Partner GmbH Steuerungssysteme

- Founded in 1991 (2013)
- Around 70 employees

#### Focal points

- Development and manufacture of components, controls and remote diagnostic systems for the lift industry

( ) = inclusion in the Schmersal Group

# Schmersal Worldwide

## International Offices

### Boituva / Brazil



#### ACE Schmersal

- Founded in 1974
- Around 400 employees

#### Focal points

- Manufacture of electromechanical and electronic switchgears
- Customer-specific control systems for the North and South American market

---

### Shanghai / China



#### Schmersal Industrial Switchgear Co. Ltd

- Founded in 1999
- Around 165 employees

#### Focal points

- Development and manufacture of switchgears for safety, automation and lift engineering for the Asian market

---

### Pune / India



#### Schmersal India Private Limited

- Founded in 2013
- Around 60 employees

#### Focal points

- Development and manufacture of switchgears for safety, automation and lift engineering for the Indian market

# Command and signalling devices

## Description

### Command and signalling devices

Command and signalling devices makes communication possible between human beings and machines. People expect high levels of reliability from them. Intuitive operation is desirable not just from an ergonomic point of view, but also with regards to safety at work.

The type of machine and the environmental conditions mean that the demands made of command and signalling devices are very different. Consequently, there are a wide range of different construction forms. In addition to classic command devices and indicator lights for installation on operator panels, pull-wire switches, foot switches, cross-switches and buttons as well as two-hand controls and enabling devices, for example are in common use.

As an all-rounder in the field of HMI components and systems, the Schmersal Group offers a range of products for (virtually) all areas of application. These include command and signalling device series that have been developed for dedicated use in hygiene-sensitive areas (Series N) as well as for extremely harsh ambient conditions (Series R).

All our ranges are distinguished by their very high levels of quality and their long service lives. They are of modular structure, which means you can adapt them in an optimum way to meet the exact requirements of your own individual application.

With contact systems too, users have different choices (see Page 72: Contact and lighting elements). Apart from this, assembly housings are available for all four series. If desired, command and signalling devices are supplied pre-assembled or ready-to-connect to operating systems with housings (see Page 90: Enclosure for surface mounting).





	"E" program	"N" program	"R" program	"A" program
<b>Area of Application</b>	Applications under difficult operating conditions	Food, hygiene and outdoor applications	Heavy-duty applications	Industrial applications
<b>Emergency-Stop push buttons</b>	 Page 12	 Page 28	 Page 44	 Page 60
<b>Illuminated signal</b>	 Page 14	 Page 30	 Page 46	 Page 62
<b>Pushbutton</b>	 Page 16	 Page 32	 Page 48	 Page 64
<b>Illuminated pushbutton</b>	 Page 16	 Page 32	 Page 48	 Page 64
<b>Mushroom head impact button/ Emergency-stop pushbutton</b>	 Page 18	 Page 34	 Page 50	 Page 66
<b>Selector switch/ button</b>	 Page 20	 Page 36	 Page 52	 Page 68
<b>Key-operated selector switch/ button</b>	 Page 22	—	 Page 54	 Page 70
<b>Step selector switch</b>	 Page 24	 Page 40	 Page 56	—
<b>Potentiometer drive</b>	 Page 24	 Page 40	 Page 56	—
<b>Main switches</b>	—	 Page 38	—	—

# Command and signalling devices

## E program

### Area of application

The Series E command and signalling devices for 22.3 mm and 30 mm installation boreholes have been developed as universal operator input and display elements for all mechanical engineering, plant construction and automotive applications. They are generally integrated in the control panels or enclosures of machines and are in use all over the world.

The separate N and R product portfolios are available for applications that make particular demands of either hygiene or the toughness of the command and signalling devices.

### Design and way of functioning

The command and signalling devices of Series E are each designed with an operating button and an EF contact system. Both parts are simply joined by catch springs. This principle ensures fast assembly on the front panel of the control panel and a permanent connection between the head and the contact system. When doing this, the modular principle of this range makes it possible to increase flexibility and to adapt the Human Machine Interface to individual requirements in an optimum way.

The control heads of Series E are made from anodized aluminium, with the collars being glass. The seals on the front of the devices complies with protection class IP 67/65.

Users can choose between a vast range of different variants. The product portfolio includes amongst other things, push buttons, mushroom head impact buttons, illuminated control push buttons and indicator lights, selector switches and selection buttons as well as key selector switches and key selection buttons.

In the E range, the mushroom head impact buttons are particularly important. They are used all over the world in mechanical engineering and plant construction and stand out due to their extremely robust design. On vibrating machines or with frequent shock loading, these EMERGENCY STOP buttons function reliably and thus increases the machines' productivity and extend their service lives. If the EMERGENCY STOP button fails, the safety system shuts down the machine, this happens extremely rarely with E and N range switchgears with an external snap-action mechanism.

Program-Overview		Page
1	Emergency stop	12
2	EMERGENCY STOP with release by key	12
3	Pushbutton	16
4	Mushroom head impact button/ Emergency-stop pushbutton	18
5	Key-operated selector switch/ button	22
6	Selector switch/key button	20
7	Illuminated pushbutton	16
8	Illuminated signal	14
9	Step selector switch	24
10	Potentiometer drive	24
11	Mounting flange EFM	77
12	Mounting flange EFMH	-
13	Short-stroke key element	-
14	Mounting flange ELM	77
15	Contact element EF	77
16	Spring element EFR	77
17	Securing plate	-
18	Position switches	-
19	Contact element EFK...	-
20	Light terminal block ELDE...	77
21	Light terminal block EL...	77
22	Emergency stop label	86
23	Emergency stop protective collar	86
24	EMERGENCY STOP enclosure for surface mounting	90
25	Identification label	86
26	Plastic enclosure for surface mounting	90
27	Adapter ring	88
28	Blanking plug	88



# Command and signalling devices – E program

## Emergency stop control devices



■ EDRR40RT

■ EDRZ40RT

■ EDRRS40RT

### Key Features

<b>General description</b>	Emergency stop command device – with twist and pull-to-unlatch mechanism	Emergency stop command device – with pull-to-unlatch mechanism	Emergency stop command device – with key unlatching mechanism
<b>Area of Application</b>	Applications under difficult operating conditions	Applications under difficult operating conditions	Applications under difficult operating conditions
<b>Mounting-Ø</b>	22.3 mm	22.3 mm	22.3 mm
<b>Housing material</b>			
<b>Material of operating element</b>	Aluminium	Aluminium	Chrome-plated brass
<b>Material front ring</b>	Aluminium	Aluminium	Aluminium

### Other versions are available

<b>Mounting-Ø 30.5 mm</b>	■	■	■
---------------------------	---	---	---

### Technical features

<b>Mechanical data</b>			
<b>Colour</b>	■	■	■
<b>Design</b>	round	round	round
<b>Front panel thickness</b>	1...6 mm	1...6 mm	1...6 mm
<b>Unlocking type</b>	Twist and pull-to-unlatch mechanism	Pull-to-unlatch mechanism	Release by key
<b>Snap-action mechanism</b>			
<b>Integrated</b>	-	■	-
<b>Externally via additional module</b>	■	-	■
<b>Mounting</b>			
<b>Mounting flange included in delivery</b>	■	■	■
<b>Mounting position</b>	any	any	any
<b>Ambient conditions</b>			
<b>Ambient temperatures</b>	-25 °C ... +75 °C	-25 °C ... +75 °C	-25 °C ... +75 °C
<b>IP Protection class</b>	IP65	IP65	IP65

### Safety classification

<b>Standards</b>	EN ISO 13850; IEC 60947-5-1; IEC 60947-5-5; IEC 60947-1	EN ISO 13850; IEC 60947-5-1; IEC 60947-5-5; IEC 60947-1	EN ISO 13850; IEC 60947-5-1; IEC 60947-5-5; IEC 60947-1
<b>Mechanical life</b>	100,000 operations	100,000 operations	100,000 operations
<b>Certificates</b>	cULus	cULus	cULus
<b>Note</b>	cULus in conjunction with the corresponding contact elements only		

## Command and signalling devices – E program

### Emergency stop control devices

Type	Unlocking	Snap-action mechanism	A	B	C	Type designation	Material number
Emergency stop command devices	Pull-to-unlatch mechanism	Integrated	29	22.3	38.5	EDRZ40 RT	101177107
				30.5		EDRZ40VH RT	101182360
	Twist and pull-to-unlatch mechanism	External with spring element EFR *	29	22.3	38.5	EDRR40 RT	101021009
					49	EDRR50 RT	101021015
				30.5	38.5	EDRR40VH RT	101024290
					49	EDRR50VH RT	101024299
	Release by key (cover red)	External with spring element EFR.EDRRS*	29	22.3	37.5	EDRRS40 RT	101025432
				30.5		EDRRS40VH RT	101025435

\* Spring element EFR or EFR.EDRRS must be ordered separately!

All dimensions in mm.

#### Key

A	Height	Height of command device in front of the front panel
B	Mounting-Ø	Installation diameter for the command device head
C	Key Ø	Width of command device head

# Command and signalling devices – E program

## Illuminated signal



■ EML / EMLH



■ EME / EMEH

### Key Features

<b>General description</b>	Illuminated signal for BA9s	Illuminated signal with integrated LED
<b>Area of Application</b>	Applications under difficult operating conditions	Applications under difficult operating conditions
<b>Mounting-Ø</b>	22.3 mm	22.3 mm
<b>Housing material</b>		
<b>Material of operating element</b>	Glass	Glass
<b>Material front ring</b>	Aluminium	Aluminium

### Other versions are available

<b>Mounting-Ø 30.5 mm</b>	■	■
<b>Vandal-proof devices</b>	■	■

### Technical features

<b>Mechanical data</b>		
<b>Colour</b>		
<b>Design</b>	Round with flat or high glass	Round with flat or high glass
<b>Front panel thickness</b>	1...6 mm	1...6 mm
<b>Integrated LED 24 VAC/DC *</b>	-	■
<b>Mounting</b>		
<b>Mounting flange included in delivery</b>	■	■
<b>Mounting position</b>	any	any
<b>Ambient conditions</b>		
<b>Ambient temperatures</b>	-25 °C ... +75 °C	-25 °C ... +40 °C
<b>IP Protection class</b>	IP65	IP65

### Safety classification

<b>Standards</b>	IEC 60947-5-1; IEC 60947-1	IEC 60947-5-1; IEC 60947-1
<b>Mechanical life</b>	-	-
<b>Certificates</b>		
<b>Note</b>	cULus in conjunction with the corresponding contact elements only	

\* A voltage sensor, e. g. an ELE is also needed for driving. You can find the voltage sensors on page 72

# Command and signalling devices – E program

## Illuminated signal

Type	Illuminant	Collar	A	B	C	Type designation
Illuminated signal	Without integrated illuminant	Flat collar	14	22.3	29.5	<b>EML</b> ①
			2.5	30.5	34.5	<b>EML.V</b> ①
		High collar	20	22.3	29.5	<b>EMLH</b> ①
			2.5	30.5	34.5	<b>EMLH.V</b> ①
LED indicator light	With integrated illuminant	High collar	20	22.3	29.5	<b>EME</b> ①

① **Abbreviations of colours:** ■ BK ■ GB ■ RD ■ GN ■ WH ■ BL  
 You append the abbreviations of the colours to the type designation.  
 For details of possible colour combinations, refer to the technical data on the previous page.

All dimensions in mm.

**Key**  
 A Height Height of command device in front of the front panel  
 B Mounting-Ø Installation diameter for the command device head  
 C Key Ø Width of command device head



EML GN



EMLH RT



EME GB



EME.V BL

# Command and signalling devices – E program

## Pushbuttons and illuminated pushbuttons



■ EDT

■ EDL

### Key Features

<b>General description</b>	Pushbutton	Illuminated pushbutton
<b>Area of Application</b>	Applications under difficult operating conditions	Applications under difficult operating conditions
<b>Mounting-Ø</b>	22.3 mm	22.3 mm
<b>Housing material</b>		
<b>Material of operating element</b>	Aluminium	Glass
<b>Material front ring</b>	Aluminium	Aluminium

### Other versions are available

<b>Mounting-Ø 30.5 mm</b>	■	■
<b>Vandal-proof devices</b>	■	■

### Technical features

<b>Mechanical data</b>		
<b>Colour</b>		
<b>Design</b>	round	round
<b>Front panel thickness</b>	1...6 mm	1...6 mm
<b>Mounting</b>		
<b>Mounting flange included in delivery</b>	■	■
<b>Mounting position</b>	any	any
<b>Ambient conditions</b>		
<b>Ambient temperatures</b>	-25 °C ... +75 °C	-25 °C ... +75 °C
<b>IP Protection class</b>	IP65	IP65

### Safety classification

<b>Standards</b>	IEC 60947-5-1; IEC 60947-1	IEC 60947-5-1; IEC 60947-1
<b>Mechanical life</b>	10,000,000 operations	5,000,000 operations
<b>Certificates</b>		
<b>Note</b>	cULus in conjunction with the corresponding contact elements only	



# Command and signalling devices – E program

## Pushbuttons and illuminated pushbuttons

Type	Description	A	B	C	Type designation	
Pushbutton	Standard	Standard	14	22.3	29.5	<b>EDT</b> ①
		2 mm-high key	16	22.3	29.5	<b>EDT2</b> ①
		6 mm-high key	20	22.3	29.5	<b>EDT6</b> ①
		6 mm edge to prevent unwanted activation	20	22.3	29.5	<b>EDTH</b> ①
	With membrane	Standard	14	22.3	29.5	<b>EDM</b> ①
		6 mm edge to prevent unwanted activation	20	22.3	29.5	<b>EDMH</b> ①
	With latching	Standard	14	22.3	29.5	<b>EDTR</b> ①
Illuminated pushbutton	Standard	Standard	14	22.3	29.5	<b>EDL</b> ①
		6 mm edge to prevent unwanted activation	20	22.3	29.5	<b>EDLH</b> ①
	With membrane	Standard	14	22.3	29.5	<b>EDLM</b> ①
		6 mm edge to prevent unwanted activation	20	22.3	29.5	<b>EDLMH</b> ①
	With latching	Standard	14	22.3	29.5	<b>EDLR</b> ①

① **Abbreviations of colours:** ■ BK ■ GB ■ RD ■ GN ■ WH ■ BL  
 You append the abbreviations of the colours to the type designation.  
 For details of possible colour combinations, refer to the technical data on the previous page.

All dimensions in mm.

### Key

A Height Height of command device in front of the front panel  
 B Mounting-Ø Installation diameter for the command device head  
 C Key Ø Width of command device head



EDM RT



EDT2 GB



EDT6.V GB



EDLMH BL



EDL GN

# Command and signalling devices – E program

## Mushroom head impact button



### Key Features

<b>General description</b>	Mushroom button without latching function	Mushroom button with latching function	Mushroom button with latching function and release by key
<b>Area of Application</b>	Applications under difficult operating conditions	Applications under difficult operating conditions	Applications under difficult operating conditions
<b>Mounting-Ø</b>	22.3 mm	22.3 mm	22.3 mm
<b>Housing material</b>			
<b>Material of operating element</b>	Aluminium	Aluminium	Chrome-plated brass
<b>Material front ring</b>	Aluminium	Aluminium	Aluminium

### Other versions are available

<b>Mounting-Ø 30.5 mm</b>	EDP40 version only	-	■
---------------------------	--------------------	---	---

### Technical features

<b>Mechanical data</b>			
<b>Colour</b>			
<b>Design</b>	round	round	round
<b>Front panel thickness</b>	1...6 mm	1...6 mm	1...6 mm
<b>With latching</b>	-	■	■
<b>Mounting</b>			
<b>Mounting flange included in delivery</b>	■	■	■
<b>Mounting position</b>	any	any	any
<b>Ambient conditions</b>			
<b>Ambient temperatures</b>	-25 °C ... +75 °C	-25 °C ... +75 °C	-25 °C ... +75 °C
<b>IP Protection class</b>	IP65	IP65	IP65

### Safety classification

<b>Standards</b>	IEC 60947-5-1; IEC 60947-1	IEC 60947-5-1; IEC 60947-1	IEC 60947-5-1; IEC 60947-1
<b>Mechanical life</b>	10,000,000 operations	10,000,000 operations	10,000,000 operations
<b>Certificates</b>			
<b>Note</b>	cULus in conjunction with the corresponding contact elements only		

# Command and signalling devices – E program

## Mushroom head impact button

Type	Description	Key	A	B	C	Type designation	
Mushroom head impact button	Mushroom head impact button	Mushroom-shaped	27.5	22.3	32	EDP ①	
			27.5	22.3	37	EDP40 ①	
			27.5	22.3	55	EDP55 ①	
			27.5	22.3	70	EDP70 ①	
		Flat key		27.5	22.3	35	EDP35 ①
	Mushroom button with latching function	Mushroom-shaped		29	22.3	38.5	EDR40 ①
				27.5	22.3	70	EDR70 ①
		Flat key		27.5	22.3	35	EDR35 ①
Release by key			29	22.3	38	EDRS40 ①	

① Abbreviations of colours:  BK  GB  RD  GN  WH  BL  
 You append the abbreviations of the colours to the type designation.  
 For details of possible colour combinations, refer to the technical data on the previous page.

All dimensions in mm.

**Key**  
 A Height Height of command device in front of the front panel  
 B Mounting-Ø Installation diameter for the command device head  
 C Key Ø Width of command device head



EDP SW



EDP70 GN



EDR35 GN



EDR70 GB



EDRS40 RT

# Command and signalling devices – E program

## Maintained selector switches and spring return selector switches



■ EWS / EWT

■ EWS .1 / EWT .1

■ EWS DB / EWT DB

### Key Features

<b>General description</b>	Selector switch/button with short toggle	Selector switch/button with long toggle	Selector switch/key button with rectangular activator
<b>Area of Application</b>	Applications under difficult operating conditions	Applications under difficult operating conditions	Applications under difficult operating conditions
<b>Mounting-Ø</b>	22.3 mm	22.3 mm	30.5 mm
<b>Toggle length</b>	28 mm	45 mm	-
<b>Housing material</b>			
<b>Material of operating element</b>	Thermoplastic	Thermoplastic	Metal
<b>Material front ring</b>	Aluminium	Aluminium	Aluminium

### Other versions are available

<b>Mounting-Ø 30.5 mm</b>	■	■	-
---------------------------	---	---	---

### Technical features











<b>Mechanical data</b>			
<b>Colour</b>	■	■	Metal (silver)
<b>Design</b>	round	round	round
<b>Front panel thickness</b>	1...6 mm	1...6 mm	1.5...14 mm
<b>Maintained switching positions</b>	2...3 positions	2...3 positions	2...3 positions
<b>Mounting</b>			
<b>Mounting flange included in delivery</b>	■	■	-
<b>Mounting position</b>	any	any	any
<b>Ambient conditions</b>			
<b>Ambient temperatures</b>	0 °C ... +75 °C	0 °C ... +75 °C	-40 °C ... +80 °C
<b>IP Protection class</b>	IP65	IP65	IP65

### Safety classification

<b>Standards</b>	IEC 60947-5-1; IEC 60947-1	IEC 60947-5-1; IEC 60947-1	IEC 60947-5-1; IEC 60947-1
<b>Mechanical life</b>	300,000 operations	300,000 operations	300,000 operations
<b>Certificates</b>			
<b>Note</b>	cULus in conjunction with the corresponding contact elements only		

## Command and signalling devices – E program

### Maintained selector switches and spring return selector switches

Type	Maintained and momentary positions	Positions	Actuator	A	B	C	Type designation
Selector switch	2 maintained positions		Short toggle	28	22.3	29.5	EWS21
			Long toggle				EWS21.1
			Rectangular actuator	6	30.5	36	EWS21DB EWS21ÖBB
	3 maintained positions		Short toggle	28	22.3	29.5	EWS32
			Long toggle				EWS32,1
			Rectangular actuator	6	30.5	36	EWS32DB EWS32ÖBB
Selector switch	1 momentary position and automatic return to the zero position		Short toggle	28	22.3	29.5	EWT21
			Long toggle				EWT21.1
			Rectangular actuator	6	30.5	36	EWT21DB EWT21ÖBB
	1 momentary position each to the right and left of the zero position		Short toggle	28	22.3	29.5	EWT32
			Long toggle				EWT32.1
			Rectangular actuator	6	30.5	36	EWT32DB EWT32ÖBB
Maintained spring-return rotary selector switch	Maintained position to left and momentary position to right		Short toggle	28	22.3	29.5	EWTS32
			Long toggle				EWTS32.1
	Maintained position on right and momentary position on left		Short toggle	6	30.5	36	EWTS321
			Long toggle				EWTS321.1

① **Toggle length:**

If you want a long toggle, append a "1" to the type designation.

All dimensions in mm.

**Key**

- A Height                      Height of command device in front of the front panel
- B Mounting-Ø                Installation diameter for the command device head
- C Key Ø                        Width of command device head

## Command and signalling devices – E program

### Key selector switches, buttons and touch contact switches



■ ESS

■ EST

#### Key Features

<b>General description</b>	Key-operated selector switch	Key-operated spring-return selector switch
<b>Area of Application</b>	Applications under difficult operating conditions	Applications under difficult operating conditions
<b>Mounting-Ø</b>	22.3 mm	22.3 mm
<b>Housing material</b>		
<b>Material of operating element</b>	Aluminium	Aluminium
<b>Material front ring</b>	Aluminium	Aluminium



#### Other versions are available

<b>Mounting-Ø 30.5 mm</b>	on request	on request
---------------------------	------------	------------

#### Technical features



<b>Mechanical data</b>		
<b>Colour</b>	Metal (silver)	Metal (silver)
<b>Design</b>	round	round
<b>Front panel thickness</b>	1...6 mm	1...6 mm
<b>Maintained switching positions</b>	2 or 3 positions	2 or 3 positions
<b>Mounting</b>		
<b>Mounting flange included in delivery</b>	■	■
<b>Mounting position</b>	any	any
<b>Ambient conditions</b>		
<b>Ambient temperatures</b>	0 °C ... +75 °C	0 °C ... +75 °C
<b>IP Protection class</b>	IP65	IP65

#### Safety classification

<b>Standards</b>	IEC 60947-5-1; IEC 60947-1	IEC 60947-5-1; IEC 60947-1
<b>Mechanical life</b>	300,000 operations	300,000 operations
<b>Certificates</b>		
<b>Note</b>	cULus in conjunction with the corresponding contact elements only	

## Command and signalling devices – E program

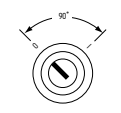
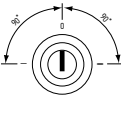
### Key selector switches, buttons and touch contact switches

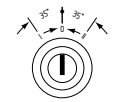
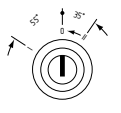
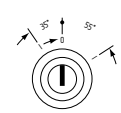
Type	Maintained and momentary positions	Key positions	Key-withdrawal position	A	B	C	Type designation
Key-operated selector switch	2 maintained positions		O	33	22.3	29.5	ESS21S1
			I				ESS21S2
			O + I				ESS21S12
	3 maintained positions		I	33	22.3	29.5	ESS32S1
			O				ESS32S2
			II				ESS32S3
			I + O + II				ESS32S123
	Key-selector switch	1 momentary position and automatic return to the zero position		O	33	22.3	29.5
2 momentary positions on the right and left with automatic return to the zero position			O	33	22.3	29.5	EST32S2
Key-operated selector switch pushbutton	3 positions: momentary position 35° actuating angle and maintained position 55° actuating angle (zero position in middle, key position at top)		I	33	30.5	34.5	ESTS32S1
			O				ESTS32S2
			O				ESTS321S2
			II				ESTS321S3

All dimensions in mm.

#### Key

A	Height	Height of command device in front of the front panel without key
B	Mounting-Ø	Installation diameter for the command device head
C	Key Ø	Width of command device head

# Command and signalling devices – E program

## Special devices



■ EWSE..K



■ EDAN6

### Key Features

<b>General description</b>	Step selector switch	Potentiometer drive
<b>Area of Application</b>	Applications under difficult operating conditions	Applications under difficult operating conditions
<b>Mounting-Ø</b>	22.3 mm	22.3 mm
<b>Housing material</b>		
<b>Material of operating element</b>	Thermoplastic	Thermoplastic
<b>Material front ring</b>	Aluminium	Aluminium

### Other versions are available

<b>Mounting-Ø 30.5 mm</b>	on request	■
---------------------------	------------	---

### Technical features

<b>Electrical data</b>		
<b>Cam-operated switch</b>	Kraus & Naimer Series CA10	-
<b>Contacts</b>	One NO contact per stage	-
<b>Insulation voltage U<sub>i</sub></b>	690V	-
<b>Utilisation category AC-15</b>	220 V...240 V / 5 A, 380 V...440 V / 4 A	-
<b>Rated impulse withstand voltage. U<sub>imp</sub></b>	6 kV	-
<b>Rated continuous current I<sub>the</sub></b>	20 A	-
<b>Fuse rating</b>	gG 25 A	-
<b>Cable section:</b>	max. 2 x 2.5 mm <sup>2</sup> *	-
<b>Mechanical data</b>		
<b>Colour</b>		
<b>Operating element</b>	■	■
<b>Front ring</b>	Silver	Silver
<b>Front panel thickness</b>	1 ... 6 mm	1 ... 6 mm
<b>Maintained switching positions</b>	3 ... 12 positions	Infinite
<b>Mounting</b>		
<b>Integrated mounting plate</b>	■	■
<b>Mounting position</b>	any	any
<b>Ambient conditions</b>		
<b>Ambient temperatures</b>	0 °C ... +60 °C	0 °C ... +75 °C
<b>IP protection class (device head)</b>	IP65	IP65

### Safety classification

<b>Standards</b>	IEC 60947-3 (VDE 0660 Part 107)	-
<b>Mechanical life</b>	Load-dependent	-
<b>Certificates</b>		-

\* Use copper conductors only



# Command and signalling devices – E program

## Special devices

Type	Circuit diagram and connecting terminals	Switching angle	L	LE	A	B	C	Type designation
Cam switching design step switches with latching mechanism, 1-pole no zero position		60°	40.7	60	28	22.3	29.5	EWSE3K
		60°	40.7	60	28	22.3	29.5	EWSE4K
		60°	50.2	69.5	28	22.3	29.5	EWSE5K
		60°	50.2	69.5	28	22.3	29.5	EWSE6K
		45°	59.7	78	28	22.3	29.5	EWSE7K
		45°	59.7	78	28	22.3	29.5	EWSE8K
		30°	69.2	87.5	28	22.3	29.5	EWSE9K
		30°	69.2	87.5	28	22.3	29.5	EWSE10K
		30°	78.7	97	28	22.3	29.5	EWSE11K
		30°	78.7	97	28	22.3	29.5	EWSE12K

Type	Description	LE	A	B	C	Type designation
Potentiometer drive	for 6 mm shaft Ø, shaft length 30 ... 40 mm	63	28	22.3	29.5	EDAN 6

All dimensions in mm.

### Key

A	Height	Height of command device in front of the front panel
B	Mounting-Ø	Installation diameter for the command device head
C	Key Ø	Width of command device head
L	Length	Length of step switch block
LE	Installation depth	Length between command device head and bottom edge of switch when mounted

# Command and signalling devices

## N program

### Area of application

Series N was originally developed for the specific requirements of food industry mechanical engineering. The command and signalling devices of the machines for this branch of industry must comply with strict hygiene requirements and be easy to clean.

Series N command and signalling devices meet the requirements of Protection class IP69K. This means that even when cleaned on a regular basis using high-pressure cleaners they have an outstanding long service life. They were designed on the basis of the general design concepts for hygienic construction of food processing machinery (EN 1762-2). This means, for example, that the geometry of the devices has no sharp edges. Type examination carried out by the Meat Trade Association confirmed that the design of the "N" program was hygiene-appropriate.

In addition, the devices are clean room-approved and also due to their resistance to spray water, they are deployed in outdoor-applications, e.g. on municipal vehicles and in car washes. Apart from this, they are tried and tested in extreme applications in food processing, e.g. fish filleting and packaging lines that are installed directly on trawlers.

### Design and way of functioning

The N series is of modular structure too which means that machine tool builders always have a wide selection of command and signalling devices available. The device heads each have one mounting flange that provides effective sealing in conjunction with a labyrinth seal. The EF contact system (see page 74) is used in exactly the same way as with the series E.

The N range is characterised by the short actuating stroke of the command devices and the high protection class even behind the front plate. This is a significant benefit in butchers' machines, for example, since condensation can form inside the machines.

The special features of the N range include main switches for up to 63 A. They allow design engineers to design the entire control unit of a (food) machine using just one range of products.

Program-Overview		Page
1	Emergency stop	28
2	Pushbutton	32
3	Mushroom head impact button/ Emergency-stop pushbutton	34
4	Selector switch/key button	36
5	Illuminated pushbutton	32
6	Illuminated signal	30
7	Step selector switch	40
8	Potentiometer drive	40
9	Mounting flange EFM	89
10	Mounting flange EFMH	89
11	Short-stroke key element	-
12	Mounting flange ELM	76
13	Contact element EF	77
14	Spring element EFR	77
15	Securing plate	-
16	Position switches	-
17	Contact element EFK...	77
18	Light terminal block ELDE...	77
19	Light terminal block EL...	77
20	Emergency stop label	86
21	Emergency stop protective collar	86
22	Identification label	86
23	Stainless steel enclosure for surface mounting	90
24	Adapter ring	88
25	Blanking plug	88



# Command and signalling devices – N program

## Emergency stop control devices



■ NDRZ50RT







■ NDRR50RT



### Key Features

<b>General description</b>	Emergency stop command device with pull-to-unlatch mechanism by integrated snap-action mechanism	Emergency stop command device with pull-to-unlatch mechanism by separate spring element
<b>Area of Application</b>	Food, hygiene and outdoor applications	Food, hygiene and outdoor applications
<b>Mounting-Ø</b>	22.3 mm	22.3 mm
<b>Housing material</b>		
<b>Material of operating element</b>	ABS	ABS
<b>Material front ring</b>	ABS, chrome-plated	ABS, chrome-plated

### Technical features

<b>Mechanical data</b>		
<b>Colour of the operating element</b>		
<b>Colour of sealing membranes</b>		
<b>Design</b>	round	round
<b>Front panel thickness</b>	1...6 mm	1...6 mm
<b>Unlocking type</b>	Pull-to-unlatch mechanism	Pull-to-unlatch mechanism
<b>Snap-action mechanism</b>		
<b>Integrated</b>	-	■
<b>Externally via additional module</b>	■	-
<b>Mounting</b>		
<b>Mounting flange included in delivery</b>	■	■
<b>Mounting position</b>	any	any
<b>Ambient conditions</b>		
<b>Ambient temperatures</b>	-25 °C ... +80 °C	-25 °C ... +80 °C
<b>IP Protection class</b>	IP69K	IP69K

### Safety classification

<b>Standards</b>	IEC 60947-5-1; IEC 60947-5-5; IEC 60947-1; EN ISO 13850	IEC 60947-5-1; IEC 60947-5-5; IEC 60947-1; EN ISO 13850
<b>Mechanical life</b>	100,000 operations	100,000 operations
<b>Certificates</b>		
<b>Note</b>	cULus in conjunction with the corresponding contact elements only	

# Command and signalling devices – N program

## Emergency stop control devices

Type	Unlocking	Snap-action mechanism	Bellows	Front ring	A	B	C	Type designation	Material number
Emergency stop command device	Pull-to-unlatch mechanism	Integrated	white	silver	45	22.3	50	<b>NDRZ50RT</b>	<b>101177168</b>
			black					<b>NDRZ50GR/RT</b>	<b>101177170</b>
			blue					<b>NDRZ50BL/RT</b>	<b>103009270</b>
			white	yellow				<b>NDRZ50RT-2905-1</b>	<b>103011890</b>
			black					<b>NDRZ50GR/RT-2905-1</b>	<b>103011811</b>
			blue					<b>NDRZ50BL/RT-2905-1</b>	<b>103011891</b>
		External with spring element EFR *	white	silver				<b>NDRR50RT</b>	<b>101163587</b>
			black					<b>NDRR50GR/RT</b>	<b>101163594</b>
			blue					<b>NDRR50BL/RT</b>	<b>103009269</b>
			white	yellow				<b>NDRR50RT-2905-1</b>	<b>103013775</b>
			black					<b>NDRR50GR/RT-2905-1</b>	<b>103013777</b>
			blue					<b>NDRR50BL/RT-2905-1</b>	<b>103013778</b>

\* Spring element EFR must be ordered separately.

Note: Front ring is yellow on devices with SPEZ 2905-1

All dimensions in mm.

### Key

A	Height	Height of command device in front of the front panel
B	Mounting-Ø	Installation diameter for the command device head
C	Key Ø	Width of command device head

# Command and signalling devices – N program

## Illuminated signal



■ NML / NMLH



■ NME / NMEH

### Key Features

<b>General description</b>	LED indicator light for LED illuminants	Illuminated signal with integrated LED
<b>Area of Application</b>	Food, hygiene and outdoor applications	Food, hygiene and outdoor applications
<b>Mounting-Ø</b>	22.3 mm	22.3 mm
<b>Housing material</b>		
<b>Material of operating element</b>	PA (12)	PA (12)
<b>Material front ring</b>	ABS, chrome-plated	ABS, chrome-plated

### Technical features

<b>Mechanical data</b>		
<b>Colour of the operating element</b>		
<b>Colour of seal</b>	–	–
<b>Design</b>	Round, flat or high collar	Round, flat or high collar
<b>Front panel thickness</b>	1...6 mm	1...6 mm
<b>Integrated LED 24 VAC/DC *</b>	–	■
<b>Mounting</b>		
<b>Mounting flange included in delivery</b>	■	■
<b>Mounting position</b>	any	any
<b>Ambient conditions</b>		
<b>Ambient temperatures</b>	–25 °C ... +80 °C	–25 °C ... +80 °C
<b>IP Protection class</b>	IP69K	IP69K

### Safety classification

<b>Standards</b>	IEC 60947-5-1; IEC 60947-1	IEC 60947-5-1; IEC 60947-1
<b>Mechanical life</b>	–	–
<b>Certificates</b>		
<b>Note</b>	cULus in conjunction with the corresponding contact elements only	

\* A voltage sensor, e.g. an ELE is also needed for driving. You can find the voltage sensors on page 72

# Command and signalling devices – N program

## Illuminated signal

Type	Description		A	B	C	Type designation
Illuminated signal	Without integrated illuminant	Flat collar	9	22.3	44.5	<b>NML</b> ①
		High collar	17.4	22.3	44.5	<b>NMLH</b> ①
LED indicator light	With integrated illuminant	Flat collar	9	22.3	44.5	<b>NMEF</b> ①
		High collar	17.4	22.3	44.5	<b>NME</b> ①

① **Abbreviations of colours:**  BK  GB  RD  GN  WH  BL  GR

You append the abbreviations of the colours to the type designation.

For details of possible colour combinations, refer to the technical data on the previous page.

All dimensions in mm.

### Key

A	Height	Height of command device in front of the front panel
B	Mounting-Ø	Installation diameter for the command device head
C	Key Ø	Width of command device head

# Command and signalling devices – N program

## Pushbuttons and illuminated pushbuttons



■ NDT

■ NDL

### Key Features

<b>General description</b>	Pushbutton	Illuminated pushbutton
<b>Area of Application</b>	Food, hygiene and outdoor applications	Food, hygiene and outdoor applications
<b>Mounting-Ø</b>	22.3 mm	22.3 mm
<b>Housing material</b>		
<b>Material of operating element</b>	ABS	PA (12)
<b>Material front ring</b>	ABS, chrome-plated	ABS, chrome-plated

### Technical features

<b>Mechanical data</b>		
<b>Colour of the operating element</b>		
<b>Colour of seal</b>		
<b>Design</b>	round	round
<b>Front panel thickness</b>	1...6 mm	1...6 mm
<b>Mounting</b>		
<b>Mounting flange included in delivery</b>	■	■
<b>Mounting position</b>	any	any
<b>Ambient conditions</b>		
<b>Ambient temperatures</b>	-25 °C ... +80 °C	-25 °C ... +80 °C
<b>IP Protection class</b>	IP69K	IP69K

### Safety classification

<b>Standards</b>	IEC 60947-5-1; IEC 60947-1	IEC 60947-5-1; IEC 60947-1
<b>Mechanical life</b>	1,000,000 operations	1,000,000 operations
<b>Certificates</b>		
<b>Note</b>	cULus in conjunction with the corresponding contact elements only	



# Command and signalling devices – N program

## Pushbuttons and illuminated pushbuttons

Type	Description		A	B	C	Type designation
<b>Pushbutton</b>	Hygiene application	"White" bellows	11	22.3	44.5	<b>NDT</b> ①
	Outdoor usage	"Black" bellows	11	22.3	44.5	<b>NDTGR</b> ①
	Hygiene application	"Blue" bellows	11	22.3	44.5	<b>NDTBL</b> ①
<b>Illuminated pushbutton</b>	Hygiene application	"White" bellows	11	22.3	44.5	<b>NDL</b> ①
	Outdoor usage	"Black" bellows	11	22.3	44.5	<b>NDLGR</b> ①
	Hygiene application	"Blue" bellows	11	22.3	44.5	<b>NDLBL</b> ①

① **Abbreviations of colours:**  BK  GB  RD  GN  WH  BL  GR

You append the abbreviations of the colours to the type designation.

For details of possible colour combinations, refer to the technical data on the previous page.

All dimensions in mm.

### Key

A	Height	Height of command device in front of the front panel
B	Mounting-Ø	Installation diameter for the command device head
C	Key Ø	Width of command device head

# Command and signalling devices – N program

## Mushroom head impact button



■ NDP

■ NDR

■ NDTP30

### Key Features

<b>General description</b>	Mushroom button without latching function	Mushroom button with latching function	Mushroom button without latching function
<b>Area of Application</b>	Food, hygiene and outdoor applications	Food, hygiene and outdoor applications	Food, hygiene and outdoor applications
<b>Mounting-Ø</b>	22.3 mm	22.3 mm	22.3 mm
<b>Housing material</b>			
<b>Material of operating element</b>	Thermoplastic	Thermoplastic	Thermoplastic
<b>Material front ring</b>	ABS, chrome-plated	ABS, chrome-plated	ABS, chrome-plated

### Technical features

<b>Mechanical data</b>			
<b>Colour of the operating element</b>			
<b>Colour of sealing membranes</b>			
<b>Design</b>	round	round	round
<b>Front panel thickness</b>	1...6 mm	1...6 mm	1...6 mm
<b>With latching</b>	-	■	-
<b>Mounting</b>			
<b>Mounting flange included in delivery</b>	■	■	■
<b>Mounting position</b>	any	any	any
<b>Ambient conditions</b>			
<b>Ambient temperatures</b>	-25 °C ... +80 °C	-25 °C ... +80 °C	-25 °C ... +80 °C
<b>IP Protection class</b>	IP69K	IP69K	IP69K

### Safety classification

<b>Standards</b>	IEC 60947-5-1; IEC 60947-1	IEC 60947-5-1; IEC 60947-1	IEC 60947-5-1; IEC 60947-1
<b>Mechanical life</b>	1,000,000 operations	1,000,000 operations	1,000,000 operations
<b>Certificates</b>			
<b>Note</b>	cULus in conjunction with the corresponding contact elements only		

# Command and signalling devices – N program

## Mushroom head impact button

Type	Description	A	B	C	Type designation	
Mushroom head impact button	Without latching	"White" bellows	45	22.3	50	<b>NDP50</b> ①
		Black "bellows"	45	22.3	50	<b>NDP50GR</b> ①
		"Blue" bellows	45	22.3	50	<b>NDP50BL</b> ①
		"White" bellows	20	22.3	30	<b>NDTP30</b> ①
		Black "bellows"	20	22.3	30	<b>NDTP30GR</b> ①
		"Blue" bellows	20	22.3	30	<b>NDTP30BL</b> ①
	Without latching, illuminated	"White" bellows	20	22.3	30	<b>NDLP30</b> ①
		Black "bellows"	20	22.3	30	<b>NDLP30GR</b> ①
		"Blue" bellows	20	22.3	30	<b>NDLP30BL</b> ①
	With integrated latching	"White" bellows	45	22.3	50	<b>NDRZ50</b> ①
		Black "bellows"	45	22.3	50	<b>NDRZ50GR</b> ①
		"Blue" bellows	45	22.3	50	<b>NDRZ50BL</b> ①
	With latching via spring element EFR*	"White" bellows	45	22.3	50	<b>NDRR50</b> ①
		Black "bellows"	45	22.3	50	<b>NDRR50GR</b> ①
		"Blue" bellows	45	22.3	50	<b>NDRR50BL</b> ①

\* Spring element EFR must be ordered separately.

① **Abbreviations of colours:**  BK  GB  RD  GN  WH  BL  GR

You append the abbreviations of the colours to the type designation.

For details of possible colour combinations, refer to the technical data on the previous page.

All dimensions in mm.

### Key

A	Height	Height of command device in front of the front panel
B	Mounting-Ø	Installation diameter for the command device head
C	Key Ø	Width of command device head

# Command and signalling devices – N program

## Maintained selector switches and spring return selector switches



■ NWS / NWT

■ NWS .1 / NWT .1

### Key Features

<b>General description</b>	Selector switches/spring-return selector switches with short toggle	Selector switches/spring-return selector switches with long toggle
<b>Area of Application</b>	Food, hygiene and outdoor applications	Food, hygiene and outdoor applications
<b>Mounting-Ø</b>	22.3 mm	22.3 mm
<b>Toggle length</b>	33 mm	46 mm
<b>Housing material</b>		
<b>Material of operating element</b>	Thermoplastic	Thermoplastic
<b>Material front ring</b>	ABS, chrome-plated	ABS, chrome-plated

### Technical features







<b>Mechanical data</b>		
<b>Colour of the operating element</b>	<input type="checkbox"/> <input checked="" type="checkbox"/>	<input type="checkbox"/> <input checked="" type="checkbox"/>
<b>Colour of seal</b>	<input type="checkbox"/> <input checked="" type="checkbox"/>	<input type="checkbox"/> <input checked="" type="checkbox"/>
<b>Design</b>	round	round
<b>Front panel thickness</b>	1...6 mm	1...6 mm
<b>Mounting</b>		
<b>Mounting flange included in delivery</b>	<input checked="" type="checkbox"/>	<input checked="" type="checkbox"/>
<b>Mounting position</b>	any	any
<b>Ambient conditions</b>		
<b>Ambient temperatures</b>	0 °C ... +80 °C	0 °C ... +80 °C
<b>IP Protection class</b>	IP69K	IP69K

### Safety classification

<b>Standards</b>	IEC 60947-5-1; IEC 60947-1	IEC 60947-5-1; IEC 60947-1
<b>Mechanical life</b>	300,000 operations	300,000 operations
<b>Certificates</b>		
<b>Note</b>	cULus in conjunction with the corresponding contact elements only	

## Command and signalling devices – N program

### Maintained selector switches and spring return selector switches

Type	Positions	Positions	Actuator	A	B	C	Type designation
Selector switch	2 maintained positions		Short toggle	26	22.3	44.5	NWS21 ①
			Long toggle	26	22.3	44.5	NWS21.1 ①
	3 maintained positions		Short toggle	26	22.3	44.5	NWS32 ①
			Long toggle	26	22.3	44.5	NWS32.1 ①
Selector switch	1 momentary position and automatic return to the zero position		Short toggle	26	22.3	44.5	NWT21 ①
			Long toggle	26	22.3	44.5	NWT21.1 ①
	1 momentary position each to the right and left of the zero position		Short toggle	26	22.3	44.5	NWT32 ①
			Long toggle	26	22.3	44.5	NWT32.1 ①
Maintained spring-return rotary selector switch	1 momentary position on the right and 2 maintained positions		Short toggle	26	22.3	44.5	NWTS32 ①
			Long toggle	26	22.3	44.5	NWTS32.1 ①
	1 momentary position on the left and 2 maintained positions		Short toggle	26	22.3	44.5	NWTS321 ①
			Long toggle	26	22.3	44.5	NWTS321.1 ①

① Abbreviation of colour:  WH  BK

If you want a white toggle, append "WH" to the type designation.

All dimensions in mm.

#### Key

A	Height	Height of command device in front of the front panel
B	Mounting-Ø	Installation diameter for the command device head
C	Key Ø	Width of command device head

# Command and signalling devices – N program

## Main switches



■ NHS16/2-pol



■ NHS40



■ NHS63

### Key Features

<b>General description</b>	Main switches 16A	Main switches 40A	Main switches 63A
<b>Area of Application</b>	Food, hygiene and outdoor applications	Food, hygiene and outdoor applications	Food, hygiene and outdoor applications
<b>Mounting</b>	Ø 22.3 mm	110 × 110 mm or Ø 22.3 mm	110 × 110 mm or Ø 22.3 mm
<b>Housing material</b>			
<b>Material of operating element</b>	Thermoplastic	Thermoplastic	Thermoplastic
<b>Material front ring</b>	ABS, chrome-plated	ABS, chrome-plated	ABS, chrome-plated

### Other versions are available

<b>Emergency stop design</b>	■	■	■
------------------------------	---	---	---

### Technical features

<b>Mechanical data</b>			
<b>Colour of the operating element</b>	■ ■	■ ■	■ ■
<b>Colour of seal</b>	■	■	■
<b>Design</b>	round	Square	Square
<b>Front panel thickness</b>	1...6 mm	1...6 mm	1...6 mm
<b>Maintained switching positions</b>	2 positions	2 positions	2 positions
<b>Mounting</b>			
<b>Mounting flange included in delivery</b>	-	-	-
<b>Integrated mounting plate</b>	■	■	■
<b>Mounting position</b>	any	any	any
<b>Ambient temperatures</b>			
<b>Open</b>	-25 °C ... +50 °C	-25 °C ... +50 °C	-25 °C ... +50 °C
<b>Enclosed</b>	-25 °C ... +40 °C	-25 °C ... +40 °C	-25 °C ... +40 °C
<b>IP Protection class</b>	IP69K	IP69K	IP69K

### Safety classification

<b>Standards</b>	IEC EN 60947, IEC EN 60204; UL 508; CSA22.2 No. 14	IEC EN 60947, IEC EN 60204; UL 508; CSA22.2 No. 14	IEC EN 60947, IEC EN 60204; UL 508; CSA22.2 No. 14
<b>Mechanical life</b>	1,000,000 operations	100,000 operations	100,000 operations
<b>Certificates</b>			

## Command and signalling devices – N program

### Main switches

Type	Series	Description		A	B	C	Type designation	Material number	
Main switches	NHS16	16 A, 2-pole	Standard	With black grip	29	22.3	70 x 80	<b>NHS16/2-POL</b>	<b>101204196</b>
			Emergency stop	With red grip + yellow background	29	22.3	Ø 100	<b>NHSNH16/2-POL</b>	<b>101209839</b>
		16 A, 4-pole	Standard	With black grip	29	22.3	70 x 80	<b>NHS16/4-POL</b>	<b>103002746</b>
			Emergency stop	With red grip + yellow background	29	22.3	Ø 100	<b>NHSNH16/4-POL</b>	<b>103002747</b>
	NHS40	40 A, 3-pole	Standard	With black grip	29	22.3	110 x 110	<b>NHS40</b>	<b>101185098</b>
			Emergency stop	With red grip + yellow background	29	22.3	110 x 110	<b>NHSNH40</b>	<b>101185097</b>
	NHS63	63 A, 3-pole	Standard	With black grip	29	22.3	110 x 110	<b>NHS63</b>	<b>101184920</b>
			Emergency stop	With red grip + yellow background	29	22.3	110 x 110	<b>NHSNH63</b>	<b>101184919</b>

All dimensions in mm.

#### Key

A	Height	Height of command device in front of the front panel
B	Mounting-Ø	Installation diameter for the command device head
C	Panel size	Dimensions of panel (if present)

# Command and signalling devices – N program

## Special devices



■ NWSE..K







■ NDAN6



### Key Features

<b>General description</b>	Step selector switch	Potentiometer drive
<b>Area of Application</b>	Food, hygiene and outdoor applications	Food, hygiene and outdoor applications
<b>Mounting-Ø</b>	22.3 mm	22.3 mm
<b>Housing material</b>		
<b>Material of operating element</b>	Thermoplastic	Thermoplastic
<b>Material front ring</b>	ABS, chrome-plated	ABS, chrome-plated

### Technical features

<b>Electrical data</b>		
<b>Cam-operated switch</b>	Kraus & Naimer Series CA10	–
<b>Contacts</b>	One NO contact per stage	–
<b>Insulation voltage <math>U_i</math></b>	690V	–
<b>Utilisation category AC-15</b>	220 V...240 V / 5 A, 380 V...440 V / 4 A	–
<b>Rated impulse withstand voltage. <math>U_{imp}</math></b>	6 kV	–
<b>Rated continuous current <math>I_{the}</math></b>	20 A	–
<b>Fuse rating</b>	gG 25 A	–
<b>Cable section:</b>	max. 2 x 2.5 mm <sup>2</sup> *	–
<b>Mechanical data</b>		
<b>Colour</b>		
<b>Operating element</b>		
<b>Front ring</b>	Silver	Silver
<b>Front panel thickness</b>	1 ... 6 mm	1 ... 6 mm
<b>Maintained switching positions</b>	3 ... 12 positions	Infinite
<b>Mounting</b>		
<b>Integrated mounting plate</b>		
<b>Mounting position</b>	any	any
<b>Ambient conditions</b>		
<b>Ambient temperatures</b>	0 °C ... +60 °C	0 °C ... +75 °C
<b>IP protection class (device head)</b>	IP69K	IP69K

### Safety classification

<b>Standards</b>	IEC 60947-3 (VDE 0660 Part 107)	–
<b>Mechanical life</b>	Load-dependent	–
<b>Certificates</b>		

\* Use copper conductors only



# Command and signalling devices – N program

## Special devices

Type	Circuit diagram and connecting terminals	Switching angle	L	LE	A	B	C	Type designation
Cam switching design step switches with latching mechanism, 1-pole no zero position		60°	40.7	60	26	22.3	44.5	NWSE3K
		60°	40.7	60	26	22.3	44.5	NWSE4K
		60°	50.2	69.5	26	22.3	44.5	NWSE5K
		60°	50.2	69.5	26	22.3	44.5	NWSE6K
		45°	59.7	78	26	22.3	44.5	NWSE7K
		45°	59.7	78	26	22.3	44.5	NWSE8K
		30°	69.2	87.5	26	22.3	44.5	NWSE9K
		30°	69.2	87.5	26	22.3	44.5	NWSE10K
		30°	78.7	97	26	22.3	44.5	NWSE11K
		30°	78.7	97	26	22.3	44.5	NWSE12K

Type	Description	LE	A	B	C	Type designation
Potentiometer drive	for 6 mm shaft Ø, shaft length 30 ... 40 mm	63	26	22.3	44.5	NDAN6

All dimensions in mm.

### Key

A	Height	Height of command device in front of the front panel
B	Mounting-Ø	Installation diameter for the command device head
C	Key Ø	Width of command device head
L	Length	Length of step switch block
LE	Installation depth	Length between command device head and bottom edge of switch when mounted

# Command and signalling devices

## R program

---

### Area of application

When designing control panels on machines that will be working under particularly harsh conditions, it is advisable to use the R product portfolio. The "R" stands for "robust", which represents the main feature of this switchgear.

---

### Design and way of functioning

Both the mechanical systems and the electrical components are of heavy-duty design. The R series is resistant to mechanical loading and you can also operate it easily when wearing gloves. The use of an adapter ring makes it possible to easily mount series R devices in a 30.5 mm installation diameter without needing additional sealing on the front panel of the machine to seal the installation hole.

The contact system (see page 78) that Schmersal developed has also been designed for a long service life under heavy loading. In the same way as with the E and N product portfolios, users can choose from a wide range of different command devices and indicator lights.

If desired, we can supply command devices pre-wired and pre-assembled in the enclosure. An ATEX-compliant version of the R series is also available.

Program-Overview		Page
1	Emergency stop	44
2	Pushbutton	48
3	Mushroom head impact button/ Emergency-stop pushbutton	50
4	Selector switch/key button	52
5	Key-operated selector switch/ button	54
6	Illuminated pushbutton	48
7	Illuminated signal	46
8	Step selector switch	56
9	Potentiometer drive	56
10	Mounting flange *	RLM *
11	Contact carrier *	
12	Plunger elements *	
13	Contact element RF...	78
14	Light terminal block RLDE...	78
15	Light terminal block RL...	78
16	Emergency stop label	86
17	Emergency stop protective collar	86
18	EMERGENCY STOP enclosure for surface mounting	90
19	Identification label	86
20	Stainless steel enclosure for surface mounting	90
21	Adapter ring	88
22	Blanking plug	88
23	Mounting tool	89

\* The RLM mounting flange consists of a mounting flange (10), a contact carrier (11) and 2 plunger elements (12).

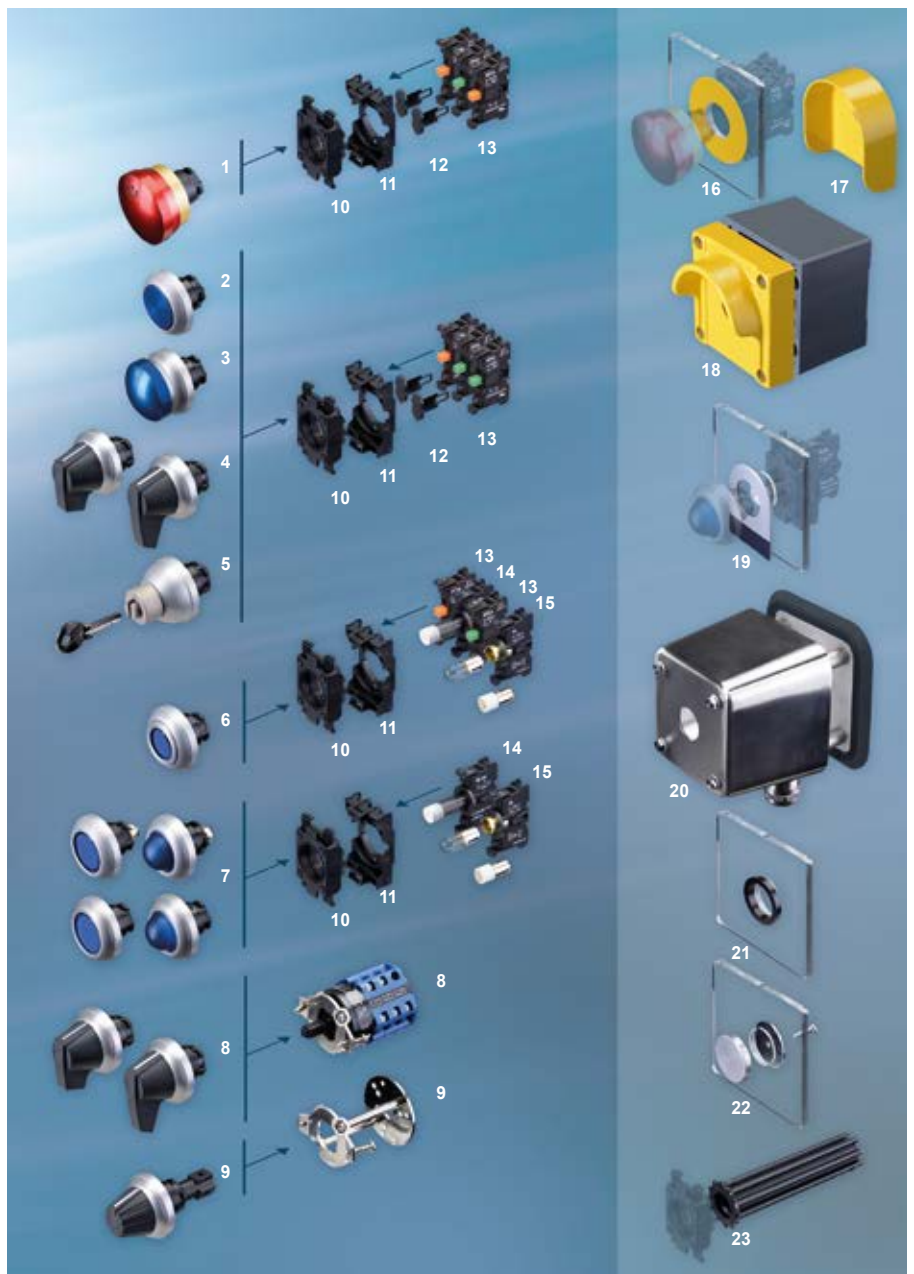

# Command and signalling devices – R program

## Emergency stop control devices



■ RDRZ45RT

### Key Features

<b>General description</b>	Emergency stop command device with pull-to-unlatch mechanism
<b>Area of Application</b>	Heavy-duty applications
<b>Mounting-Ø</b>	22.3 mm
<b>Housing material</b>	
<b>Material of operating element</b>	Aluminium
<b>Material front ring</b>	Aluminium

### Other versions are available

<b>ATEX design</b>	■
--------------------	---

### Technical features

<b>Mechanical data</b>	
<b>Colour of the operating element</b>	■
<b>Design</b>	round
<b>Front panel thickness</b>	1...6 mm
<b>Unlocking type</b>	Pull-to-unlatch mechanism
<b>Snap-action mechanism</b>	
<b>Integrated</b>	■
<b>Externally via additional module</b>	-
<b>Mounting</b>	
<b>Mounting flange included in delivery</b>	■
<b>Mounting position</b>	any
<b>Ambient conditions</b>	
<b>Ambient temperatures</b>	-25 °C ... +75 °C
<b>IP Protection class</b>	IP65

### Safety classification

<b>Standards</b>	IEC 60947-5-1; IEC 60947-5-5; IEC 60947-1; EN ISO 13850
<b>Mechanical life</b>	100,000 operations
<b>Certificates</b>	
<b>Note</b>	cULus in conjunction with the corresponding contact elements only

## Command and signalling devices – R program

### Emergency stop control devices

Type	Unlocking	Snap-action mechanism	A	B	C	Type designation	Material number
<b>Emergency stop command device</b>	Pull-to-unlatch mechanism	Integrated	27.5	22.3	45	<b>RDRZ45RT</b>	<b>101193576</b>

All dimensions in mm.

#### Key

A	Height	Height of command device in front of the front panel
B	Mounting-Ø	Installation diameter for the command device head
C	Key Ø	Width of command device head

# Command and signalling devices – R program

## Illuminated signal



■ RMLF/RMLH



■ RMEF/RMEH

### Key Features

<b>General description</b>	Illuminated signal for BA9s	Illuminated signal with integrated LED
<b>Area of Application</b>	Heavy-duty applications	Heavy-duty applications
<b>Mounting-Ø</b>	22.3 mm	22.3 mm
<b>Housing material</b>		
<b>Material of operating element</b>	Glass / PA (12)	Glass / PA (12)
<b>Material front ring</b>	Aluminium	Aluminium

### Other versions are available

<b>ATEX design</b>	■	-
--------------------	---	---

### Technical features

<b>Mechanical data</b>		
<b>Colour</b>		
<b>Design</b>	Round with flat or high glass	Round with flat or high glass
<b>Front panel thickness</b>	1...6 mm	1...6 mm
<b>Integrated LED 24 VAC/DC *</b>	-	■
<b>Mounting</b>		
<b>Mounting flange included in delivery</b>	■	■
<b>Mounting position</b>	any	any
<b>Ambient conditions</b>		
<b>Ambient temperatures</b>	-25 °C ... +75 °C	-25 °C ... +40 °C
<b>IP Protection class</b>	IP65	IP65

### Safety classification

<b>Standards</b>	IEC 60947-5-1; IEC 60947-1	IEC 60947-5-1; IEC 60947-1
<b>Mechanical life</b>	-	-
<b>Certificates</b>		
<b>Note</b>	cULus in conjunction with the corresponding contact elements only	

\* A voltage sensor, e.g. an RE is also needed for driving. You can find the voltage sensors on page 78

## Command and signalling devices – R program

### Illuminated signal

Type	Description		A	B	C	Type designation
Illuminated signal	Without integrated illuminant	Flat collar	11	22.3	39.5	RML ①
		High collar	21.5	22.3	39.5	RMLH ①
LED indicator light	With integrated illuminant	Flat collar	11	22.3	39.5	RMEF ①
		High collar	21.5	22.3	39.5	RMEH ①

① Abbreviations of colours:  BK  GB  RD  GN  WH  BL  GR

You append the abbreviations of the colours to the type designation.

For details of possible colour combinations, refer to the technical data on the previous page.

All dimensions in mm.

#### Key

A	Height	Height of command device in front of the front panel
B	Mounting-Ø	Installation diameter for the command device head
C	Key Ø	Width of command device head

# Command and signalling devices – R program

## Pushbuttons and illuminated pushbuttons



■ RDT

■ RDL

### Key Features

<b>General description</b>	Pushbutton	Illuminated pushbutton
<b>Area of Application</b>	Heavy-duty applications	Heavy-duty applications
<b>Mounting-Ø</b>	22.3 mm	22.3 mm
<b>Housing material</b>		
<b>Material of operating element</b>	Aluminium	Glass
<b>Material front ring</b>	Aluminium	Aluminium

### Other versions are available

<b>ATEX design</b>	■	■
--------------------	---	---

### Technical features

<b>Mechanical data</b>		
<b>Colour</b>		
<b>Design</b>	round	round
<b>Front panel thickness</b>	1...6 mm	1...6 mm
<b>Mounting</b>		
<b>Mounting flange included in delivery</b>	■	■
<b>Mounting position</b>	any	any
<b>Ambient conditions</b>		
<b>Ambient temperatures</b>	-25 °C ... +75 °C	-25 °C ... +75 °C
<b>IP Protection class</b>	IP65	IP65

### Safety classification

<b>Standards</b>	IEC 60947-5-1; IEC 60947-1	IEC 60947-5-1; IEC 60947-1
<b>Mechanical life</b>	10,000,000 operations	10,000,000 operations
<b>Certificates</b>		
<b>Note</b>	cULus in conjunction with the corresponding contact elements only	



## Command and signalling devices – R program

### Pushbuttons and illuminated pushbuttons

Type	Description	A	B	C	Type designation
Pushbutton	Standard	11	22.3	39.5	<b>RDT</b> ①
	With membrane	11	22.3	39.5	<b>RDM</b> ①
Illuminated pushbutton	Standard	11	22.3	39.5	<b>RDL</b> ①
	With membrane	11	22.3	39.5	<b>RDLM</b> ①

① **Abbreviations of colours:** ■ BK ■ GB ■ RD ■ GN □ WH ■ BL ■ GR

You append the abbreviations of the colours to the type designation.

For details of possible colour combinations, refer to the technical data on the previous page.

All dimensions in mm.

#### Key

A	Height	Height of command device in front of the front panel
B	Mounting-Ø	Installation diameter for the command device head
C	Key Ø	Width of command device head

# Command and signalling devices – R program

## Mushroom head impact button



■ RDP40



■ RDRZ45

### Key Features

<b>General description</b>	Mushroom button without latching function	Mushroom button with latching function
<b>Area of Application</b>	Heavy-duty applications	Heavy-duty applications
<b>Mounting-Ø</b>	22.3 mm	22.3 mm
<b>Housing material</b>		
<b>Material of operating element</b>	Aluminium	Aluminium
<b>Material front ring</b>	Aluminium	Aluminium

### Other versions are available

<b>ATEX design</b>	■	■
--------------------	---	---

### Technical features

<b>Mechanical data</b>		
<b>Colour</b>		
<b>Design</b>	round	round
<b>Front panel thickness</b>	1...6 mm	1...6 mm
<b>With latching</b>	-	■
<b>Mounting</b>		
<b>Mounting flange included in delivery</b>	■	■
<b>Mounting position</b>	any	any
<b>Ambient conditions</b>		
<b>Ambient temperatures</b>	-25 °C ... +75 °C	-25 °C ... +75 °C
<b>IP Protection class</b>	IP65	IP65

### Safety classification

<b>Standards</b>	IEC 60947-5-1; IEC 60947-1	IEC 60947-5-1; IEC 60947-1
<b>Mechanical life</b>	10,000,000 operations	10,000,000 operations
<b>Certificates</b>		
<b>Note</b>	cULus in conjunction with the corresponding contact elements only	

# Command and signalling devices – R program

## Mushroom head impact button

Type	Description		A	B	C	Type designation
Mushroom head impact button	without latching	Mushroom-shaped	27	22.3	39.5	RDP40 ①
	with latching	Mushroom-shaped	27	22.3	45	RDRZ45 ①

① Abbreviations of colours:  BK  GB  RD  GN  WH  BL

You append the abbreviations of the colours to the type designation.

For details of possible colour combinations, refer to the technical data on the previous page.

All dimensions in mm.

### Key

A	Height	Height of command device in front of the front panel
B	Mounting-Ø	Installation diameter for the command device head
C	Key Ø	Width of command device head

# Command and signalling devices – R program

## Maintained selector switches and spring return selector switches



■ RWS / RWT

■ RWS .1 / RWT .1

### Key Features

<b>General description</b>	Selector switches/spring-return selector switches with short toggle	Selector switches/spring-return selector switches with long toggle
<b>Area of Application</b>	Heavy-duty applications	Heavy-duty applications
<b>Mounting-Ø</b>	22.3 mm	22.3 mm
<b>Toggle length</b>	40 mm	49 mm
<b>Housing material</b>		
<b>Material of operating element</b>	Thermoplastic	Thermoplastic
<b>Material front ring</b>	Aluminium	Aluminium

### Other versions are available

<b>ATEX design</b>	■	■
--------------------	---	---

### Technical features







<b>Mechanical data</b>		
<b>Colour</b>	■	■
<b>Design</b>	round	round
<b>Front panel thickness</b>	1...6 mm	1...6 mm
<b>Maintained switching positions</b>	2...3 positions	2...3 positions
<b>Mounting</b>		
<b>Mounting flange included in delivery</b>	■	■
<b>Mounting position</b>	any	any
<b>Ambient conditions</b>		
<b>Ambient temperatures</b>	0 °C ... +75 °C	0 °C ... +75 °C
<b>IP Protection class</b>	IP65	IP65

### Safety classification

<b>Standards</b>	IEC 60947-5-1; IEC 60947-1	IEC 60947-5-1; IEC 60947-1
<b>Mechanical life</b>	300,000 operations	300,000 operations
<b>Certificates</b>	cULus	cULus
<b>Note</b>	cULus in conjunction with the corresponding contact elements only	

## Command and signalling devices – R program

### Maintained selector switches and spring return selector switches

Type	Maintained and momentary positions	Positions	Actuator	A	B	C	Type designation
Selector switch	2 maintained positions		Short toggle	32	22.3	39.5	<b>RWS21</b>
			Long toggle	32	22.3	39.5	<b>RWS21.1</b>
	3 maintained positions		Short toggle	32	22.3	39.5	<b>RWS32</b>
			Long toggle	32	22.3	39.5	<b>RWS32.1</b>
Selector switch	1 momentary position and automatic return to the zero position		Short toggle	32	22.3	39.5	<b>RWT21</b>
			Long toggle	32	22.3	39.5	<b>RWT21.1</b>
	1 momentary position each to the right and left of the zero position		Short toggle	32	22.3	39.5	<b>RWT32</b>
			Long toggle	32	22.3	39.5	<b>RWT32.1</b>
Maintained spring-return rotary selector switch	1 momentary position on the right and 2 maintained positions		Short toggle	32	22.3	39.5	<b>RWTS32</b>
			Long toggle	32	22.3	39.5	<b>RWTS32.1</b>
	1 momentary position on the left and 2 maintained positions		Short toggle	32	22.3	39.5	<b>RWTS321</b>
			Long toggle	32	22.3	39.5	<b>RWTS321.1</b>

① **Toggle length:**

If you want a long toggle, append a "1" to the type designation.

All dimensions in mm.

**Key**

A	Height	Height of command device in front of the front panel
B	Mounting-Ø	Installation diameter for the command device head
C	Key Ø	Width of command device head

## Command and signalling devices – R program

### Key selector switches, buttons and -touch contact switches



■ RSS

■ RST

#### Key Features

<b>General description</b>	Key-operated selector switch	Key-operated spring-return selector switch
<b>Area of Application</b>	Heavy-duty applications	Heavy-duty applications
<b>Mounting-Ø</b>	22.3 mm	22.3 mm
<b>Housing material</b>		
<b>Material of operating element</b>	Aluminium	Aluminium
<b>Material front ring</b>	Aluminium	Aluminium

#### Other versions are available

<b>ATEX design</b>	-	-
--------------------	---	---

#### Technical features

<b>Mechanical data</b>		
<b>Colour</b>	Metal (silver)	Metal (silver)
<b>Design</b>	round	round
<b>Front panel thickness</b>	1...6 mm	1...6 mm
<b>Maintained switching positions</b>	2 or 3 positions	2 or 3 positions
<b>Mounting</b>		
<b>Mounting flange included in delivery</b>	■	■
<b>Mounting position</b>	any	any
<b>Ambient conditions</b>		
<b>Ambient temperatures</b>	0 °C ... +75 °C	0 °C ... +75 °C
<b>IP Protection class</b>	IP65	IP65

#### Safety classification

<b>Standards</b>	IEC 60947-5-1; IEC 60947-1	IEC 60947-5-1; IEC 60947-1
<b>Mechanical life</b>	300,000 operations	300,000 operations
<b>Certificates</b>	cULus	cULus
<b>Note</b>	cULus in conjunction with the corresponding contact elements only	

## Command and signalling devices – R program

### Key selector switches, buttons and -touch contact switches

Type	Maintained and momentary positions	Positions	Key-withdrawal position	A	B	C	Type designation
Key-operated selector switch	2 maintained positions		O	31.5	22.3	39.5	RSS21S1
			I	31.5	22.3	39.5	RSS21S2
			O + I	31.5	22.3	39.5	RSS21S12
	3 maintained positions		I	31.5	22.3	39.5	RSS32S1
			O	31.5	22.3	39.5	RSS32S2
			II	31.5	22.3	39.5	RSS32S3
I + O + II	31.5	22.3	39.5	RSS32S123			
Key-selector switch	1 momentary position and automatic return to the zero position		O	31.5	22.3	39.5	RST21S1
	2 momentary positions on the right and left with automatic return to the zero position		O	31.5	22.3	39.5	RSTS32S2
Key-operated selector switch pushbutton	3 positions: momentary position 35° actuating angle and maintained position 55° actuating angle (zero position in middle, key position at top)		I	31.5	22.3	39.5	RSST32S1
			O	31.5	22.3	39.5	RSTS32S2
			O	31.5	22.3	39.5	RSTS321S2
			II	31.5	22.3	39.5	RSTS32S3

All dimensions in mm.

#### Key

A	Height	Height of command device in front of the front panel without key
B	Mounting-Ø	Installation diameter for the command device head
C	Key Ø	Width of command device head

# Command and signalling devices – R program

## Special devices



■ RWSE..K



■ RDAN6

### Key Features

<b>General description</b>	Step selector switch	Potentiometer drive
<b>Area of Application</b>	Heavy-duty applications	Heavy-duty applications
<b>Mounting-Ø</b>	22.3 mm	22.3 mm
<b>Housing material</b>		
<b>Material of operating element</b>	Thermoplastic	Thermoplastic
<b>Material front ring</b>	Aluminium	Aluminium

### Other versions are available

<b>ATEX design</b>	-	-
--------------------	---	---

### Technical features

<b>Electrical data</b>		
<b>Cam-operated switch</b>	Kraus & Naimer Series CA10	-
<b>Contacts</b>	One NO contact per stage	-
<b>Insulation voltage <math>U_i</math></b>	690 V	-
<b>Utilisation category AC-15</b>	220 V ... 240 V / 5 A, 380 V ... 440 V / 4 A	-
<b>Rated impulse withstand voltage. <math>U_{imp}</math></b>	6 kV	-
<b>Rated continuous current <math>I_{the}</math></b>	20 A	-
<b>Fuse rating</b>	gG 25 A	-
<b>Cable section:</b>	max. 2 x 2.5 mm <sup>2</sup> *	-
<b>Mechanical data</b>		
<b>Colour</b>		
<b>Operating element</b>	■	■
<b>Front ring</b>	Silver	Silver
<b>Front panel thickness</b>	1 ... 6 mm	1 ... 6 mm
<b>Maintained switching positions</b>	3 ... 12 positions	Infinite
<b>Mounting</b>		
<b>Integrated mounting plate</b>	■	■
<b>Mounting position</b>	any	any
<b>Ambient conditions</b>		
<b>Ambient temperatures</b>	0 °C ... +60 °C	0 °C ... +75 °C
<b>IP protection class (device head)</b>	IP65	IP65

### Safety classification

<b>Standards</b>	IEC 60947-3 (VDE 0660 Part 107)	-
<b>Mechanical life</b>	Load-dependent	-
<b>Certificates</b>		-



# Command and signalling devices – R program

## Special devices

Type	Circuit diagram and connecting terminals	Switching angle	L	LE	A	B	C	Type designation	Material number
Cam switching design step switches with latching mechanism, 1-pole no zero position		60°	40.7	60	32	22.3	54	<b>RWSE3K.1</b>	<b>101195857</b>
		60°	40.7	60	32	22.3	54	<b>RWSE4K.1</b>	<b>101195858</b>
		60°	50.2	69.5	32	22.3	54	<b>RWSE5K.1</b>	<b>101195859</b>
		60°	50.2	69.5	32	22.3	54	<b>RWSE6K.1</b>	<b>101195860</b>
		45°	59.7	78	32	22.3	54	<b>RWSE7K.1</b>	<b>101195861</b>
		45°	59.7	78	32	22.3	54	<b>RWSE8K.1</b>	<b>101195862</b>
		30°	69.2	87.5	32	22.3	54	<b>RWSE9K.1</b>	<b>101195863</b>
		30°	69.2	87.5	32	22.3	54	<b>RWSE102K.1</b>	<b>101195864</b>
		30°	78.7	97	32	22.3	54	<b>RWSE11K.1</b>	<b>101195865</b>
		30°	78.7	97	32	22.3	54	<b>RWSE12K.1</b>	<b>101195866</b>

Type	Description	LE	A	B	C	Type designation
Potentiometer drive	for 6 mm shaft Ø, shaft length 30 ... 40 mm	63	31	22.3	39.5	<b>RDAN6</b>

All dimensions in mm.

### Key

A	Height	Height of command device in front of the front panel
B	Mounting-Ø	Installation diameter for the command device head
C	Key Ø	Width of command device head
L	Length	Length of step switch block
LE	Installation depth	Length between command device head and bottom edge of switch when mounted

# Command and signalling devices

## A program

### Range AVANTGARDE

If you consider the exceptional design and follow the definition "direction (in art, science and politics), that stands aggressively for new ideas", this helps to understand the reason for the name, and you certainly realise that the name AVANTGARDE for this command and signalling device is certainly the right one.

Control panels and command panels receive a special outfit with these devices, they are highlighted and their frequent wallflower existence has been removed.

#### Technical advantages

The features of the AVANTGARDE is not only due to its design. Additionally there are a range of constructive and functional benefits, some ergonomic, some functional, which highlight and emphasize the exclusiveness of the design.

Included here for example is an installation depth of less than 40 mm behind the front plate, a push button stroke of only 3.5 mm, also a flexible and installation friendly element system.

With the AVANTGARDE program, all commercially available device types are offered with the design of a modern command and signalling device program, which includes illuminated selector switches and switches in different colours. The devices comply with all relevant norms and reach the protection class IP65.

---

### Design and way of functioning

#### Push button with patented shape (DE 197 30 680 C 1)

The special form of the button and in connection with an actuating stroke of only 3.5 mm and a lower actuating force in comparison to many other devices, allow an ergonomic and tireless actuation of the push buttons, illuminated push buttons and similar. Also long finger nails are not a problem or better still are protected (keyword: "fingernail safe").

#### Time saving device installation.

The installation of the device requires an installation height of only 22.3 mm using coupling nuts, snap-contact elements and minimal time.

#### Modular element system

Equipping: Up to a maximum of 5 contacts, with illuminated devices up to a maximum of 4 contact elements and with emergency stop devices up to a maximum of 3 contact elements using the safety plate to secure the contacts. Both NC and NO contact elements are available with screw clamps.

#### Low installation depth

Installation compatibility even with limited space behind the front plate. Installation depth with a maximum of three elements: < 40mm. Can be installed in many commercially available command boxes (recommended overall depth: minimum 57 mm).

\* See mounting instruction: Page: 84

Program-Overview		Page
1	Emergency stop	60
2	Pushbutton	64
3	Mushroom head impact button/ Emergency-stop pushbutton	66
4	Maintained selector switches / spring-return selector switches	68
5	Key-operated selector switch/ button	70
6	Illuminated pushbutton	64
7	Illuminated signal	62
8	Contact element AF...	82
9	Light element AL...	82
10	Emergency stop label	86
11	EMERGENCY STOP enclosure for surface mounting	90
12	Identification label	86
13	Blanking plug	88
14	Dust shield cap	88
15	Mounting tool	89
16	Spare key	88
17	Removal tool	89

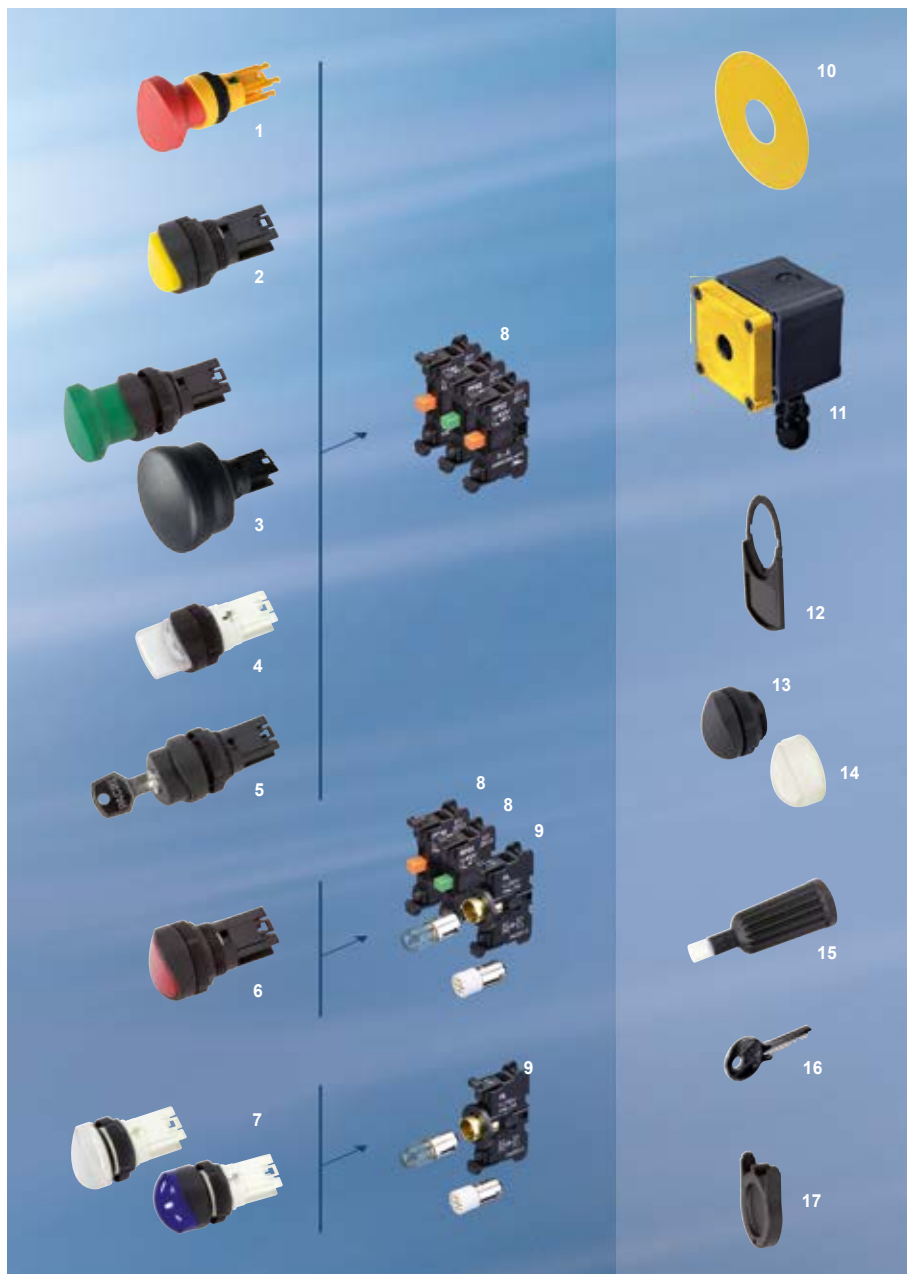

# Command and signalling devices – A program

## Emergency stop control devices



■ ADRR40

### Key Features

<b>General description</b>	Emergency stop command device
<b>Area of Application</b>	Industrial applications
<b>Mounting-Ø</b>	22.3 mm
<b>Housing material</b>	
<b>Material of operating element</b>	Thermoplastic
<b>Material front ring</b>	Thermoplastic

### Other versions are available

<b>Mounted in housing</b>	MBKAC311YE-ADRR40RT-2NC
---------------------------	-------------------------

### Technical features

<b>Mechanical data</b>	
<b>Colour</b>	
<b>Design</b>	round
<b>Front panel thickness</b>	1...6 mm
<b>Unlocking type</b>	Pull-to-unlatch mechanism
<b>Snap-action mechanism</b>	
<b>Integrated</b>	■
<b>Externally via additional module</b>	-
<b>Mounting</b>	
<b>Connection</b>	Knurled nut, central mounting
<b>Mounting position</b>	any
<b>Ambient conditions</b>	
<b>Ambient temperatures</b>	-25 °C ... +60 °C
<b>IP Protection class</b>	IP65

### Safety classification

<b>Standards</b>	EN ISO 13850
<b>B<sub>10d</sub> NC contact</b>	100,000 operations
<b>Certificates</b>	
<b>Note</b>	cULus in conjunction with the corresponding contact elements only

## Command and signalling devices – A program

### Emergency stop control devices

Type	Unlocking	Snap-action mechanism	A	B	C	Type designation	Material number
Emergency stop command devices	Pull-to-unlatch mechanism	Integrated	38	22.3	40	ADRR40RT	101030271
EMERGENCY STOP complete housing	Pull-to-unlatch mechanism	Integrated	93	–	40	MBKAC311YE-ADRR40RT-2NC	103009572
EMERGENCY STOP complete housing	Pull-to-unlatch mechanism	Integrated	93	–	40	MBKAC311YE-ADRR40RT-2NC-1NO	103011887

All dimensions in mm.

#### Key

A	Height	Height of command device in front of the front panel
B	Mounting-Ø	Installation diameter for the command device head
C	Key Ø	Width of command device head

#### EMERGENCY STOP complete housing



# Command and signalling devices – A program

## Illuminated signal



■ AML

■ AMLH

### Key Features

<b>General description</b>	Flatter indicator light	Higher indicator light
<b>Area of Application</b>	Industrial applications	Industrial applications
<b>Mounting-Ø</b>	22.3 mm	22.3 mm
<b>Housing material</b>		
<b>Material of operating element</b>	Thermoplastic	Thermoplastic
<b>Material front ring</b>	Thermoplastic	Thermoplastic

### Other versions are available

<b>With symbols</b>	-	-
---------------------	---	---

### Technical features

<b>Mechanical data</b>		
<b>Colour</b>		
<b>Design</b>	round	round
<b>Front panel thickness</b>	1...6 mm	1...6 mm
<b>Illumination *</b>	■	■
<b>Mounting</b>		
<b>Connection</b>	Knurled nut, central mounting	Knurled nut, central mounting
<b>Mounting position</b>	any	any
<b>Ambient conditions</b>		
<b>Ambient temperatures</b>	-25 °C ... +60 °C	-25 °C ... +60 °C
<b>IP Protection class</b>	IP65	IP65

### Safety classification

<b>Standards</b>	IEC 60947-5-1; IEC 60947-1	IEC 60947-5-1; IEC 60947-1
<b>Mechanical life</b>	-	-
<b>Certificates</b>		
<b>Note</b>	cULus in conjunction with the corresponding contact elements only	

\* A voltage sensor (AL) is also required and Ba9s LED.

# Command and signalling devices – A program

## Illuminated signal

Type	Illuminant	Collar	A	B	C	Type designation	Material number
Illuminated signal	Without integrated illuminant	Flat collar	10.3	22.3	29	AMLGB	101031181
			10.3	22.3	29	AMLRT	101031180
			10.3	22.3	29	AMLGN	101031182
			10.3	22.3	29	AMLWS	101031179
			10.3	22.3	29	AMLBL	101031183
		High collar	13.8	22.3	29	AMLHGB	101031573
			13.8	22.3	29	AMLHRT	101031572
			13.8	22.3	29	AMLHGN	101031574
			13.8	22.3	29	AMLHWS	101031571
			13.8	22.3	29	AMLHBL	101031575

**Abbreviations of colours:** ■ SW ■ GB ■ RT ■ GN □ WS ■ BL

You append the abbreviations of the colours to the type designation.

For details of possible colour combinations, refer to the technical data on the previous page.

All dimensions in mm.

### Key

A	Height	Height of command device in front of the front panel
B	Mounting-Ø	Installation diameter for the command device head
C	Key Ø	Width of command device head

# Command and signalling devices – A program

## Pushbuttons and illuminated pushbuttons



### Key Features

General description	Pushbutton	Double push button	Illuminated pushbutton
Area of Application	Industrial applications	Industrial applications	Industrial applications
Mounting-Ø	22.3 mm	22.3 mm	22.3 mm
Housing material			
Material of operating element	Thermoplastic	Thermoplastic	Thermoplastic
Material front ring	Thermoplastic	Thermoplastic	Thermoplastic

### Other versions are available

With high edge	on request	-	on request
----------------	------------	---	------------

### Technical features

Mechanical data			
Colour			
Design	round	round	round
Front panel thickness	1...6 mm	1...6 mm	1...6 mm
Illumination *	-	optionally in the middle	■
Mounting			
Connection	Knurled nut, central mounting	Knurled nut, central mounting	Knurled nut, central mounting
Mounting position	any	any	any
Ambient conditions			
Ambient temperatures	-25 °C ... +60 °C	-25 °C ... +60 °C	-25 °C ... +60 °C
IP Protection class	IP65	IP65	IP65

### Safety classification

Standards	IEC 60947-5-1; IEC 60947-1	IEC 60947-5-1; IEC 60947-1	IEC 60947-5-1; IEC 60947-1
Mechanical life	5,000,000 operations	5,000,000 operations	5,000,000 operations
Certificates			
Note	cULus in conjunction with the corresponding contact elements only		

\* A voltage sensor (AL) is also required and Ba9s LED.



# Command and signalling devices – A program

## Pushbuttons and illuminated pushbuttons

Type	Description		A	B	C	Type designation	Material number
Pushbutton	Standard	Standard	10.3	22.3	29	ADTSW	101031584
			10.3	22.3	29	ADTGB	101031593
			10.3	22.3	29	ADTRT	101031592
			10.3	22.3	29	ADTGN	101031594
			10.3	22.3	29	ADTWS	101031591
			10.3	22.3	29	ADTBL	101031595
		With high button	13.3	22.3	29	ADT3SW	101031585
			13.3	22.3	29	ADT3GB	101031588
			13.3	22.3	29	ADT3RT	101031587
			13.3	22.3	29	ADT3GN	101031589
			13.3	22.3	29	ADT3WS	101031586
Illuminated pushbutton	Standard	Standard	10.3	22.3	29	ADLGB	101031176
			10.3	22.3	29	ADLRT	101031175
			10.3	22.3	29	ADLGN	101031177
			10.3	22.3	29	ADLWS	101031174
			10.3	22.3	29	ADLBL	101031178
		With high button	13.3	22.3	29	ADL3GB	101031713
			13.3	22.3	29	ADL3RT	101031712
			13.3	22.3	29	ADL3GN	101031714
			13.3	22.3	29	ADL3WS	101031711
			13.3	22.3	29	ADL3BL	101031715
			Double push button	2 button surfaces	With illumination	10.3	22.3
Without illumination	10.3	22.3			29 x 57	ADDT-GN-RT	103010798
	10.3	22.3			29 x 57	ADDT-SW-SW	103010799

**Abbreviations of colours:** ■ SW ■ GB ■ RT ■ GN □ WS ■ BL

You append the abbreviations of the colours to the type designation.

For details of possible colour combinations, refer to the technical data on the previous page.

All dimensions in mm.

### Key

A	Height	Height of command device in front of the front panel
B	Mounting-Ø	Installation diameter for the command device head
C	Key Ø	Width of command device head

# Command and signalling devices – A program

## Mushroom head impact button



■ ADP

■ ADP 55.3

### Key Features

<b>General description</b>	Mushroom button without latching function	Mushroom button without latching function
<b>Special features</b>	-	<b>Actuating force 7 N</b>
<b>Area of Application</b>	Industrial applications	Industrial applications
<b>Mounting-Ø</b>	22.3 mm	22.3 mm
<b>Housing material</b>		
<b>Material of operating element</b>	Thermoplastic	Thermoplastic
<b>Material front ring</b>	Thermoplastic	Thermoplastic

### Other versions are available

<b>With symbols</b>	■	■
---------------------	---	---

### Technical features

<b>Mechanical data</b>		
<b>Colour</b>		
<b>Design</b>	round	round
<b>Front panel thickness</b>	1...6 mm	1...6 mm
<b>With latching</b>	-	-
<b>Mounting</b>		
<b>Connection</b>	Knurled nut, central mounting	Knurled nut, central mounting
<b>Mounting position</b>	any	any
<b>Ambient conditions</b>		
<b>Ambient temperatures</b>	-25 °C ... +60 °C	-25 °C ... +60 °C
<b>IP Protection class</b>	IP65	IP65

### Safety classification

<b>Standards</b>	IEC 60947-5-1; IEC 60947-1	IEC 60947-5-1; IEC 60947-1
<b>Mechanical life</b>	5,000,000 operations	5,000,000 operations
<b>Certificates</b>		
<b>Note</b>	cULus in conjunction with the corresponding contact elements only	

## Command and signalling devices – A program

### Mushroom head impact button

Type	Key	Actuating force	A	B	C	Type designation	Material number
Mushroom button without latching function	palm form	approx. 9 N	31.3	22.3	33	ADPSW	101031583
			31.3	22.3	33	ADPRT	101031596
			31.3	22.3	33	ADPGN	101031597
	flatter wider mushroom	approx. 7 N	36	22.3	55	ADP55.3SW/O.F	101054131
		approx. 10.5 N	36	22.3	55	ADP55.3SW	101054132

**Abbreviations of colours:** ■ SW ■ GB ■ RT ■ GN □ WS ■ BL

You append the abbreviations of the colours to the type designation.

For details of possible colour combinations, refer to the technical data on the previous page.

All dimensions in mm.

#### Key

A	Height	Height of command device in front of the front panel
B	Mounting-Ø	Installation diameter for the command device head
C	Key Ø	Width of command device head

# Command and signalling devices – A program

## Selector switch / button



■ AWS / AWT



■ AWSL / AWTL

### Key Features

<b>General description</b>	Selector switch/key button	Illuminated selector switch/button
<b>Area of Application</b>	Industrial applications	Industrial applications
<b>Mounting-Ø</b>	22.3 mm	22.3 mm
<b>Housing material</b>		
<b>Material of operating element</b>	Thermoplastic	Thermoplastic
<b>Material front ring</b>	Thermoplastic	Thermoplastic

### Other versions are available

<b>With long toggle</b>	■	-
-------------------------	---	---

### Technical features

<b>Mechanical data</b>		
<b>Colour</b>		
<b>Design</b>	round	round
<b>Front panel thickness</b>	1...6 mm	1...6 mm
<b>Illumination *</b>	-	■
<b>Maintained switching positions</b>	2...3 positions	2...3 positions
<b>Mounting</b>		
<b>Connection</b>	Knurled nut, central mounting	Knurled nut, central mounting
<b>Mounting position</b>	any	any
<b>Ambient conditions</b>		
<b>Ambient temperatures</b>	-25 °C ... +60 °C	-25 °C ... +60 °C
<b>IP Protection class</b>	IP65	IP65





### Safety classification

<b>Standards</b>	IEC 60947-5-1; IEC 60947-1	IEC 60947-5-1; IEC 60947-1
<b>Mechanical life</b>	100,000 operations	100,000 operations
<b>Certificates</b>		
<b>Note</b>	cULus in conjunction with the corresponding contact elements only	

\* A voltage sensor (AL) for actuation is also required and Ba9s LED.

# Command and signalling devices – A program

## Selector switch / button

Type	Maintained and momentary positions	Switching angle	Actuator	A	B	C	Type designation
Selector switch	2 maintained positions		Short toggle	25.8	22.3	29	<b>AWS21</b> ①
			Long toggle	25.8	22.3	40	<b>AWS21.1</b> ①
			Illuminated short toggle	25.8	22.3	29	<b>AWSL21</b> ①
	3 maintained positions		Short toggle	25.8	22.3	29	<b>AWS32</b> ①
			Long toggle	25.8	22.3	40	<b>AWS32.1</b> ①
			Illuminated short toggle	25.8	22.3	29	<b>AWSL32</b> ①
Selector switch	2 sensing positions		Short toggle	25.8	22.3	29	<b>AWT21</b> ①
			Long toggle	25.8	22.3	40	<b>AWT21.1</b> ①
			Illuminated short toggle	25.8	22.3	29	<b>AWTL21</b> ①
	3 sensing positions		Short toggle	25.8	22.3	29	<b>AWT32</b> ①
			Long toggle	25.8	22.3	40	<b>AWT32.1</b> ①
			Illuminated short toggle	25.8	22.3	29	<b>AWTL32</b> ①

① Abbreviations of colours:  BK  GB  RD  GN  WH  BL

You append the abbreviations of the colours to the type designation.

For details of possible colour combinations, refer to the technical data on the previous page.

All dimensions in mm.

### Key

A	Height	Height of command device in front of the front panel
B	Mounting-Ø	Installation diameter for the command device head
C	Key Ø	Width of command device head

# Command and signalling devices – A program

## Key-operated selector switch



■ ASS

### Key Features

<b>General description</b>	Key-operated selector switch
<b>Area of Application</b>	Industrial applications
<b>Mounting-Ø</b>	22.3 mm
<b>Housing material</b>	
<b>Material of operating element</b>	Thermoplastic
<b>Material front ring</b>	Thermoplastic

### Other versions are available

<b>Other closure possibilities</b>	on request
<b>Other removal positions</b>	on request

### Technical features



<b>Mechanical data</b>	
<b>Colour</b>	■
<b>Design</b>	round
<b>Front panel thickness</b>	1...6 mm
<b>Maintained switching positions</b>	2...3 positions
<b>Mounting</b>	
<b>Connection</b>	Knurled nut, central mounting
<b>Mounting position</b>	any
<b>Ambient conditions</b>	
<b>Ambient temperatures</b>	-25 °C ... +60 °C
<b>IP Protection class</b>	IP65

### Safety classification

<b>Standards</b>	IEC 60947-5-1; IEC 60947-1
<b>Mechanical life</b>	100,000 operations
<b>Certificates</b>	
<b>Note</b>	cULus in conjunction with the corresponding contact elements only

# Command and signalling devices – A program

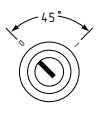
## Key-operated selector switch

Type	Maintained positions	Key positions	Key-withdrawal position	A	B	C	Type designation	Material number
Key-operated selector switch	2 maintained positions		O	50	22.3	29	ASS21S1	101192840
			O + I	50	22.3	29	ASS21S12	101031173
	3 maintained positions		O	50	22.3	29	ASS32S2	103001868
			I + O + II	50	22.3	29	ASS32S123	101031598

All dimensions in mm.

### Key

A	Height	Height of command device in front of the front panel with key
B	Mounting-Ø	Installation diameter for the command device head
C	Key Ø	Width of command device head

# Command and signalling devices

## Contact and lighting elements

### Area of application

The Schmersal Group has developed its own contact systems for series E, N and R command and signalling devices, which guarantee exceptional contacting even under the harshest ambient conditions.

The command and signalling devices from the Avantgarde range are specially designed for the needs of industrial applications. Quick efficient installation of the device with a knurled nut. A contact carrier has been integrated directly on the command device so that the contact elements can be pushed on and engaged on the command device easily without an additional mounting flange. Also the contact elements are easy to install with a screwdriver or to remove with the removing tool. This reduces expensive installation time to a minimum.

### Design and way of functioning

All the elements of the EF system have a special low-voltage-capable and self-cleaning four-way contact bridge system. This is a twin contact bridge that works in-parallel as well as crosswise. In this way, the fixed contact and the moveable contact bridge always achieve several contacts. This ensures high levels of contact security that is enhanced by the shape of the fixed contacts. Apart from this, the contacts have a self-cleaning function that removes oxide and dirt particles before they are deposited and are able to affect operation of the switchgear.

The EF contact system can be supplied in four terminations:

- Screw terminals
- Cage clamp
- Blade terminal
- Direct mounting on PCB

The RF contact system is used with series R command devices. Installation is particularly user-friendly as the RF contact system's mounting flange comprises of two parts and allows users to pre-mount the contact elements, while the other part is used for fastening the device head and subsequent attachment of the contact carrier. With this contact system, users have a free choice of contacts, since the contact elements can be mounted on two levels.

The contact element of the type AF is specially designed for a time-saving device installation. Thanks to the recessed guide rails, they are connected directly to the command device without a contact carrier or similar. Thanks to the omission of an attachment or mounting flange, a very low installation depth of under 40 mm is also achieved (emergency stop 47 mm).

Also the AF contact system is a modular contact system, that due to the doubling of the contacts can accept up to five contact elements (different with emergency stop). This offers the machine and plant manufacturer the possibility to decide how many NO or NC contacts are to be used and installed. This modular contact system also contributes to a reduction in costs. Emergency stop command devices can accept up to three contact elements. These are secured against popping off with an additional safety plate.



## EF contact elements

Principle design of EF contact elements

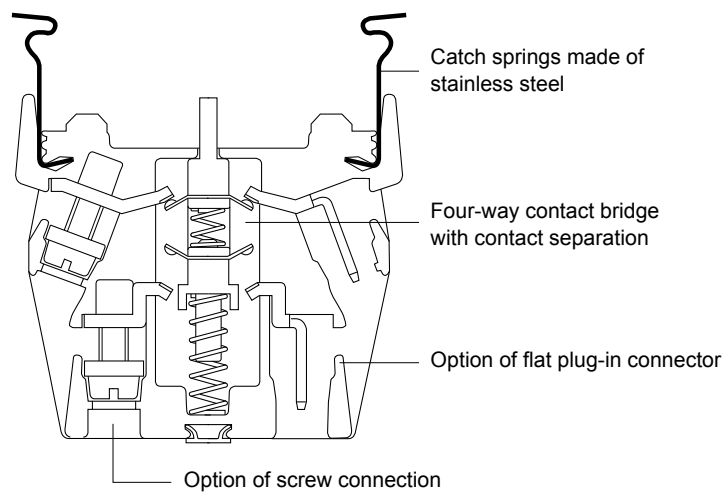

## Four-way contact bridge

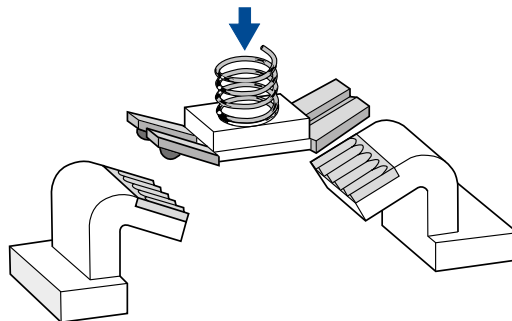

The electrical way of working of the contact elements is based on the Elan four-way contact. This is a twin contact bridge that works in-parallel as well as crosswise. The high contact security that is provided due to several contactings by the fixed contact and the moveable contact bridge is enhanced for industrial practice by the fixed contacts being angled and embossed several times. The self-cleaning feature of the contacts reliably removes any oxide or dirt particles that may be produced due to operation at extra-low voltages.

# Contact and lighting elements

## Technical data – Range EF



■ EF

### Key Features

General description	Contact elements
Can be used with	E and N product portfolios

### Other versions are available

ATEX design	-
-------------	---

### Technical features

Design	EF
Material	
Material of the enclosure	Plastic, glass-fibre-reinforced, self-extinguishing
Material of the contacts	Fine-silver, phosphor bronze or brass carrier
Utilisation category AC-15; DC-13	250 V / 8 A; 24 V / 5 A
Suitability for low voltages	> 5 VDC / 3.2 mA
Rated insulation voltage $U_i$	400 V
Rated impulse withstand voltage. $U_{imp}$	4 kV
Thermal test current $I_{the}$	10 A
Max. fuse rating	gG 10 A
Switching frequency	1200 s/h
Mechanical life	10,000,000 operations
Resistance to shock	110 g / 4 ms ... 30 g / 18 ms no bouncing
Resistance to vibration	> 20 g / 10 ... 200 Hz *
Ambient temperature	-25 °C ... +80 °C
Connection	
Screw terminals	Yes
Flat plug-in connector	Yes
Cage clamp connection	Yes
Cable section	
Solid wire	2 × (0.5 ... 2.5 mm <sup>2</sup> )
Stranded wire	2 × (0.5 ... 1.5 mm <sup>2</sup> )
Blade terminal	6.3 mm × 0.8 mm / 2 × 2.8 mm × 0.8 mm
Protection class terminals**/switch rooms	IP20 / IP40

### Safety classification

Standards	IEC 60947-5-1; IEC 60947-1
$B_{10d}$	100,000 operations
Certificates	 ***

\* For actuating heads with higher mass, appropriately lower

\*\* With plug-in connectors, depends on the connector plug used

\*\*\* Except for cage clamp connections



■ EL / ELE



■ ELDE

Light terminal block with Ba9S base  
E and N product portfolios

Light terminal block with LED  
E and N product portfolios

EL

EL

Plastic, glass-fibre-reinforced, self-extinguishing

Plastic, glass-fibre-reinforced, self-extinguishing

Appropriate to the respective version

Appropriate to the respective version

-25 °C ... +80 °C

-25 °C ... +80 °C

Yes  
depending on the version  
depending on the version

Yes  
No  
No

2 × (0.5 ... 2.5 mm<sup>2</sup>)  
2 × (0.5 ... 1.5 mm<sup>2</sup>)  
6.3 mm × 0.8 mm /  
2 × 2.8 mm × 0.8 mm  
IP20 / -

2 × (0.5 ... 2.5 mm<sup>2</sup>)  
2 × (0.5 ... 1.5 mm<sup>2</sup>)  
6.3 mm × 0.8 mm /  
2 × 2.8 mm × 0.8 mm  
IP20 / -

IEC 60947-5-1; IEC 60947-1

IEC 60947-5-1; IEC 60947-1



# Contact and lighting elements

## Type EF and EL

Pushbutton	Mounting flange EFM		
	Position 2	Position 3	Position 1
Emergency stop command device	Contact element EF...	Spring element EFR	Contact element EF...
Pushbutton	Contact element EF...	Contact element EF...	Contact element EF...
Mushroom head impact button			
Selector switch/key button			
Key-operated selector switch/button			

Pushbutton	Mounting flange ELM		
	Position 2	Position 3	Position 1
Illuminated pushbutton	Contact element EF	Light terminal block EL...	Contact element EF
Illuminated signal	–	Light terminal block EL...	–

### Design

A control and indicator device consists of an actuator, a mounting flange and a contact or light element (in the case of emergency stop devices, possibly plus a spring element).

### Assembly example

This example shows an illuminated push button with ELM mounting flange, 2 EF... contact elements and an EL... lighting element

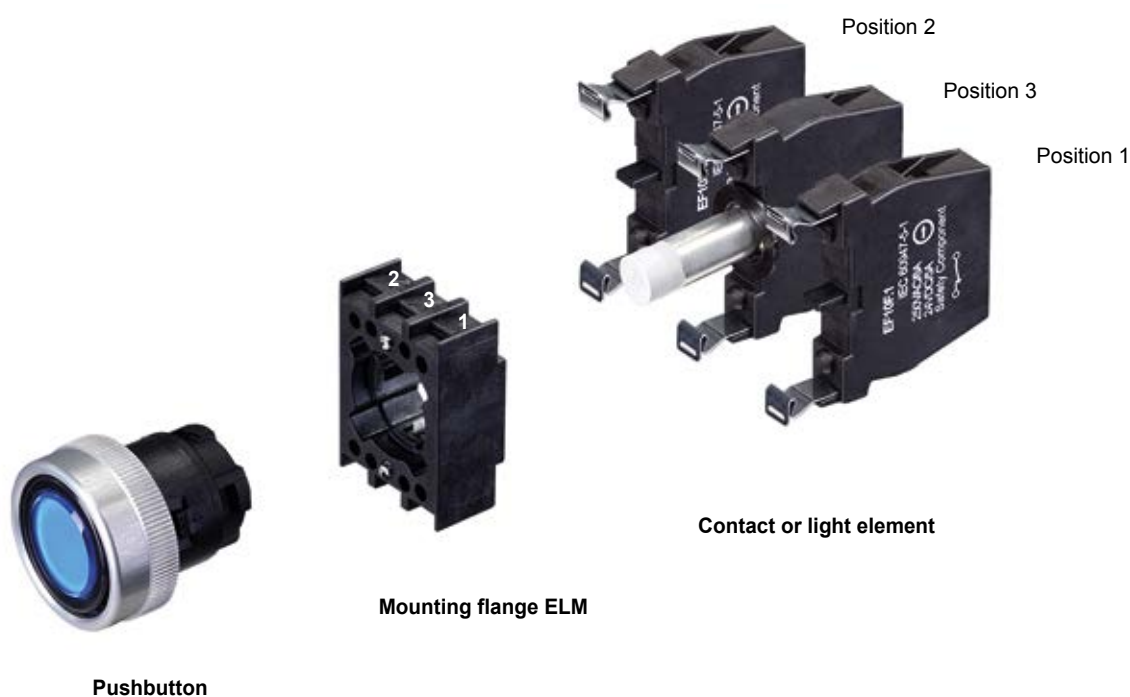

# Contact and lighting elements

## Type EF and EL

Type	Application	Function	Switch travel diagram	Position	Wiring configuration according to DIN 50005	Screw terminals	Flat plug-in connector	WAGO-Cage clamp
Contact element	Emergency stop	2 NC		1	11-12/21-22	EF220.1	EF220F.1	-
				2	31-32/41-42	EF220.2	EF220F.2	-
		1 NC contact / 1 NO contact		1	11-12/23-24	EF303.1	EF303F.1	-
				2	31-32/43-44	EF303.2	EF303F.2	-
	Standard	1 NC		1	11-12	EF10.1	EF10F.1	EFK10.1
				2	21-22	EF10.2	EF10F.2	EFK10.2
				3	31-32	EF10.3	EF10F.3	EFK10.3
		1 NO		1	13-14	EF03.1	EF03F.1	EFK03.1
				2	23-24	EF03.2	EF03F.2	EFK03.2
				3	33-34	EF03.3	EF03F.3	EFK03.3
		2 NO		1	13-14/23-24	EF033.1	EF033F.1	EFK033.1
				2	33-34/43-44	EF033.2	EF033F.2	EFK033.2
				3	53-54/63-64	EF033.3	EF033F.3	-
		1 NC contact / 1 NO contact		1	11-12/23-24	EF103.1	EF103F.1	EF103.1
				2	31-32/43-44	EF103.2	EF103F.2	EF103.2
				3	51-52/63-64	EF103.3	EF103F.3	-
		1 NC contact / 1 NO contact overlapping		1	11-12/23-24	EF301.1	EF301F.1	-
				2	31-32/43-44	EF301.2	EF301F.2	-
3	51-52/63-64			EF301.3	EF301F.3	-		

Type	Illuminant	Function	Diagram	Position	Description	Screw terminals	Flat plug-in connector	WAGO-Cage clamp
Light terminal block	Ba9S socket *	Lighting element / voltage sensor for lamps + acoustic signal		3	Standard	EL	ELF	-
				3	with transformer	ELT	ELTF	-
				3	with series resistor	ELV	ELVF	-
		Lighting element / voltage sensor for LED		3	24 VAC/DC	ELE	-	ELEK
				3	48 VAC/DC primary ... 24 V secondary	ELE 48	-	-
				3	115 ... 230 VAC primary 24 V secondary	ELE 230	-	-
	Integrated LED	Light element with integrated LED		3	Red LED	ELDE.N RT 24	-	ELDEK RT
				3	Yellow LED	ELDE.N GB 24	-	ELDEK GB
				3	green LED	ELDE.N GN 24	-	ELDEK GN
				3	LED blue	ELDE.N BL 24	-	ELDEK BL
				3	LED white	ELDE.N WS 24	-	ELDEK WS
Integrated LED	Light element with integrated LED		3	LED red, green, yellow	ELDE.N-RD-GN-YE-24VDC	-	-	

Type	Application	Function	Position	Description	Screw terminals	Flat plug-in connector	WAGO-Cage clamp
EFR, EDRRS or EFR	Emergency stop	Snap-action mechanism with latching	3	Spring element	-	-	-

\* Illuminant not included in delivery!

# Contact and lighting elements

## Technical data – Range RF



RF

### Key Features

General description	Contact elements
Can be used with	"R" program

### Other versions are available

ATEX design	■
-------------	---

### Technical features

Design	RF
Material	
Material of the enclosure	Plastic, glass-fibre-reinforced, self-extinguishing
Material of the contacts	Fine-silver, phosphor bronze or brass carrier
Utilisation category AC-15; DC-13	250 V / 6 A; 24 V / 3 A
Suitability for low voltages	>5VDC / 1 mA
Rated insulation voltage $U_i$	400 V
Rated impulse withstand voltage. $U_{imp}$	4 kV
Thermal test current $I_{the}$	6 A
Max. fuse rating	gG 6 A
Switching frequency	1200 s/h
Mechanical life	10,000,000 operations
Resistance to shock	110 g / 4 ms ... 30 g / 18 ms no bouncing
Resistance to vibration	> 20 g / 10 ... 200 Hz *
Ambient temperature	-25 °C ... +75 °C
Connection	
Screw terminals	Yes
Flat plug-in connector	No
Cage clamp connection	No
Cable section	
Solid wire	2 x (0.5 ... 2.5 mm <sup>2</sup> )
Stranded wire	2 x (0.5 ... 1.5 mm <sup>2</sup> )
Blade terminal	-
Protection class terminals**/switch rooms	IP20 / IP40

### Safety classification

Standards	IEC 60947-5-1; IEC 60947-1
$B_{10d}$	100,000 operations
Certificates	

\* For actuating heads with higher mass, appropriately lower

\*\* With plug-in connectors, depends on the connector plug used

\*\*\* Except for cage clamp connections



■ RL



■ RLDE

Light terminal block with Ba9S base  
"R" program

Light terminal block with LED  
"R" program

-

■

RL

RL

Plastic, glass-fibre-reinforced, self-extinguishing

Plastic, glass-fibre-reinforced, self-extinguishing

-

-

-

-

-

-

-

-

-

-

Appropriate to the respective version

Appropriate to the respective version

-

-

-

-

-

-

-25 °C ... +75 °C

-25 °C ... +75 °C

Yes

Yes

No

No

No

No

2 x (0.5 ... 2.5 mm<sup>2</sup>)

2 x (0.5 ... 2.5 mm<sup>2</sup>)

2 x (0.5 ... 1.5 mm<sup>2</sup>)

2 x (0.5 ... 1.5 mm<sup>2</sup>)

-

-

IP20 / -

IP20 / -

IEC 60947-5-1; IEC 60947-1

IEC 60947-5-1; IEC 60947-1

-

-



# Contact and lighting elements

## Type RF and RL

Pushbutton	Mounting flange RLM		
	Position 2	Position 1	Position 3
Emergency stop command device	Contact element RF...	Contact element RF...	Contact element RF...
Pushbutton			
Mushroom head impact button			
Selector switch/key button			
Key-operated selector switch/button			
Illuminated pushbutton	Contact element RF...	Light terminal block RL...	Contact element RF...
Illuminated signal	–	Light terminal block RL...	–

### Design

The contact bracket is for preassembling the RF contact elements or the RL or RLDE lighting elements.

The scope of supply of the fastening flange includes a mounting flange, a contact carrier and 2 plunger elements.

### Assembly example

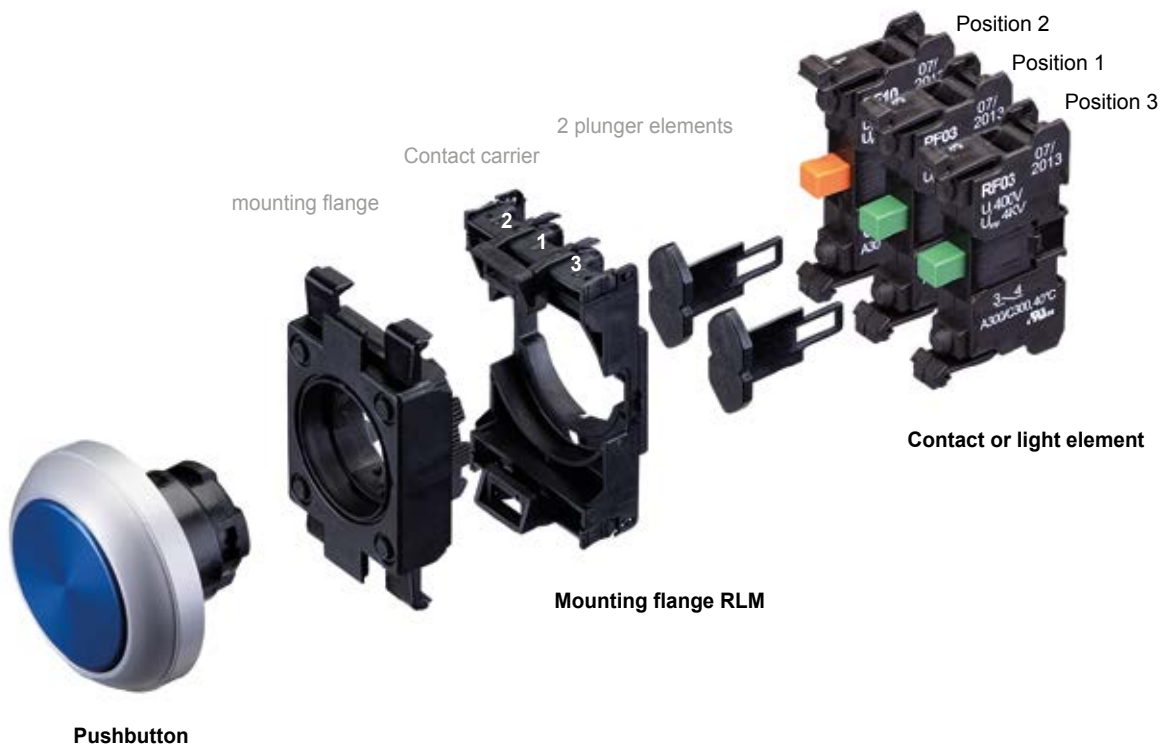

This example shows a mushroom button with an RLM mounting flange (comprising of a mounting flange, a contact carrier and two plunger elements) and 3 RF03 contact elements.





# Contact and lighting elements

## Type RF and RL

Type	Application	Function	Switch travel diagram	Position	Connection	Plunger colour	Contact labelling	Type designation
Contact element	Standard and emergency stop	1 NC		1, 2 and 3	Screw terminals	red	1, 2	<b>RF10</b>
		1 NO		1, 2 and 3	Screw terminals	green	11, 12	<b>RF10.1</b>
							3, 4	<b>RF03</b>
							13, 14	<b>RF03.1</b>

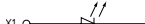
Type	Illuminant	Diagram	Position	Connection	Contact labelling	Type designation
Light terminal block	Ba9S socket *		1	Screw terminals	X1-X2	<b>RL</b>
	Integrated LED		1	Screw terminals	X1-X2	<b>RLDEWS24</b>

\* Illuminant not included in delivery!

# Contact and lighting elements

## Technical data – Range AF



■ AF

### Key Features

General description	Contact elements
<b>Technical features</b>	
Design	AF
Material	
Material of the enclosure	Plastic, self-extinguishing
Material of the contacts	Fine-silver, phosphor bronze or brass carrier
Utilisation category AC-15; DC-13	250 V / 6 A; 24 V / 3 A
Rated insulation voltage $U_i$	400 V
Rated impulse withstand voltage. $U_{imp}$	2.5 kV
Thermal test current $I_{the}$	6 A
Max. fuse rating	gG 6 A
Switching frequency	1200 s/h
Mechanical life	5,000,000 operations
Resistance to shock	30 g / 18 ms
Resistance to vibration	20 g / 10 ... 150 Hz
Ambient temperature	-25 °C ... +60 °C
Connection	
Screw terminals	Yes
Cable section	
Solid / stranded wire	2 x 1.5 mm <sup>2</sup>
Protection class terminals/switch rooms	IP20 / IP40

### Safety classification

Standards	IEC 60947-5-1; IEC 60947-1
$B_{10d}$	100,000 operations
Certificates	



■ AL

Light terminal block

AL

Plastic, self-extinguishing

-

-

-

-

-

Appropriate to the respective version

-

-

30 g / 18 ms  
(Note lamp value!)

-

-25 °C ... +40 °C

Yes

2 x 1.5 mm<sup>2</sup>  
IP20 / IP40

IEC 60947-5-1; IEC 60947-1

-



# Contact and lighting elements

## Type AF and AL

Pushbutton	Position 1	Position 3	Position 2
Emergency stop command device			
Pushbutton			
Mushroom head impact button	Contact element AF...	Contact element AF...	Contact element AF...
Selector switch/key button			
Key-operated selector switch/button			
Illuminated pushbutton	Contact element AF...	Light element AL...	Contact element AF...
Illuminated signal	-	Light element AL...	-

### Assembly example

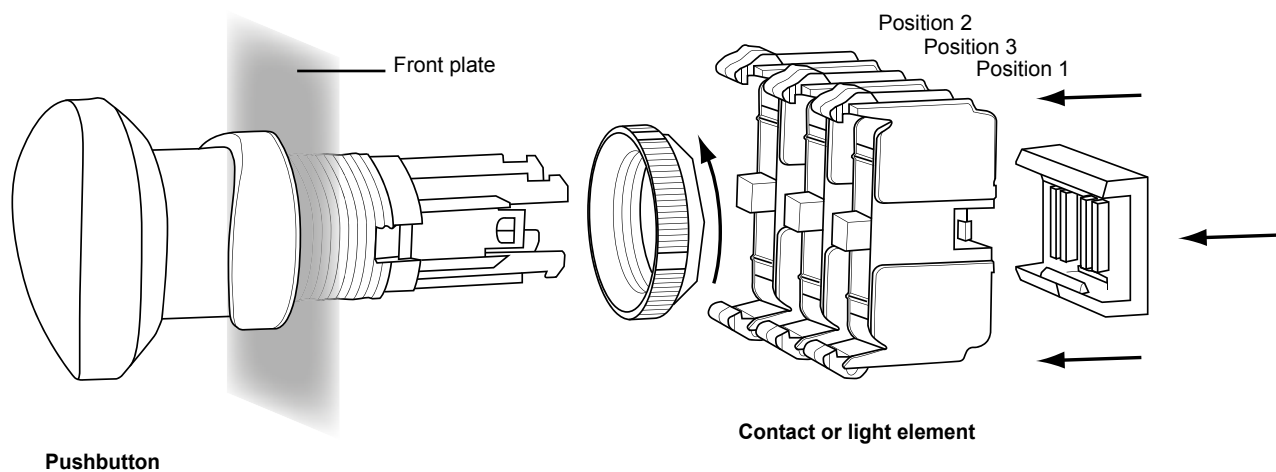

# Contact and lighting elements

## Type AF and AL

Type	Application	Function	Position	Connection	Plunger colour	Contact labelling	Type designation	Material number
Contact element	Standard and emergency stop	1 NC	1, 2 and 3	Screw terminals	red	1, 2	AF10	101030064
		1 NO	1, 2 and 3	Screw terminals	green	3, 4	AF02	101030065

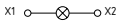
Type	Illuminant	Diagram	Position	Connection	Contact labelling	Type designation	Material number
Light terminal block	Without *		3	Screw terminals	X1 - X2	AL	101031578

\* The right lamp with the size Ba9S has to be ordered separately.

### Dismantling example

Using a screwdriver

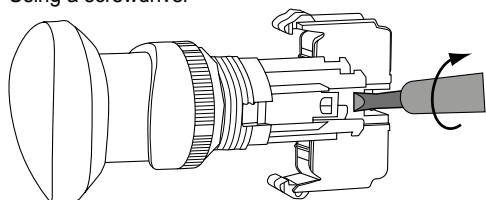

without any removal tools

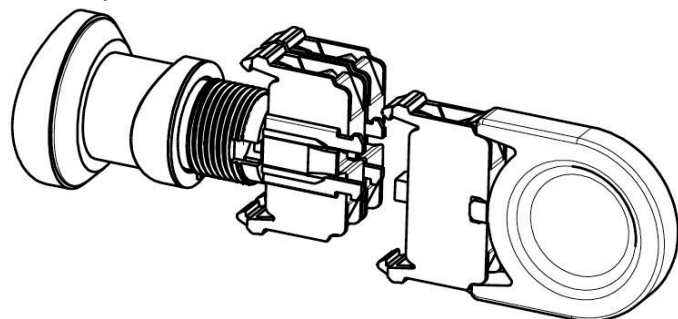

# Command and signalling devices



## Accessories

Type	Description	Type designation	Recommended for product portfolio			
			E	N	R	A
Emergency stop label	Installation Ø for 22.3 mm, 53 mm external Ø	MDP-8	■		■	
	Mounting-Ø for 22.3 mm, external Ø 53 mm, plastic	MDP-8.2				■
	Installation Ø for 22.3 mm, 100 mm external Ø	MDP-6	■		■	
	Installation Ø for 30.5 mm, 53 mm external Ø	DPF-9	■		■	
	Installation Ø for 30.5 mm, 100 mm external Ø	DPF-7	■		■	
	External Ø 70 mm, V4A version, colour yellow, self-adhesive, no labelling	NDP-70	■	■	■	
	External Ø 65 mm plastic – as adhesive foil	NDP-65	■	■	■	
Protective collar	Emergency stop protective collar, installation Ø for 22.3 mm operating element Ø 38,5 mm	EDRR-1 SET	■			
	Emergency stop protective collar, installation Ø for 22.3 mm operating element Ø 49 mm	EDRR-2 SET	■		■	
	Emergency stop protective collar, installation Ø for 30.5 mm operating element Ø 38.5 mm	EDRR-1.1 SET	■			
	Emergency stop protective collar, installation Ø for 30.5 mm operating element Ø 49 mm	EDRR-2.1 SET	■		■	
	Emergency stop protective collar, material 1.4550, incl. fastening screws	NSK/V4A/GB		■		
	Protective collar to prevent accidental touching for pushbuttons and illuminated pushbuttons	NSK-GR		■		
Selector switch lock	Selector switch lock for two-position selector switch	NWSP21GR		■		
	Selector switch lock for three-position selector switch	NWSP32GR		■		
Blanking plug	Blanking plug, metallized	NB		■		
	Blanking plug, stainless steel	NB/VA		■		
	Blanking plug, installation Ø 22.3 mm	MBN	■			
	Blanking plug, installation Ø 30.5 mm	BN	■		■	
	Blanking plug, installation Ø 22.3 mm	ABN				■
Dust shield cap	Dust shield cap for lamps and push buttons	AMT				■
Identification label	Identification label, small	NZSO/V4A		■		
	Identification label, large	NZSO2/V4A		■		
	Identification label, small	RZSO			■	
	Identification label, medium	RZSO1			■	
	Identification label, large	RZSO2			■	
	Identification label, aluminium	MZSO	■			
	Identification label, plastic	KZSO	■			
	Identification label, 30.5 mm, small	ZSO2	■			
	Identification label, 30.5 mm, large	ZSO	■			
	Identification label, 30.5 mm, large	ZSNO	■			
Identification label	AZSO				■	
Adapter ring	Adapter ring with gasket for using Ø 22 mm operating buttons to 30.5 mm drilled holes	NUE		■		
	Adapter ring with gasket for using Ø 22 mm operating buttons to 30.5 mm drilled holes	RUE			■	
	Adapter ring with gasket for using Ø 22 mm operating buttons to 30.5 mm drilled holes	MUE	■			
Spare key	Spare key for key selector switch	SDS1/SDS2	■		■	
	Spare key for key selector switch	A-S				■

# Command and signalling devices

## Accessories

Type	Description	Type designation	Recommended for product portfolio			
			E	N	R	A
mounting flange	Mounting flange	EFM	■	■	-	
	Mounting flange	ELM	■	■	-	
	Mounting flange for position switch	EFMH	■	■		
	Mounting flange	RLM			■	
	Driver for contact elements	R-F			■	
Mounting tool	Mounting tool for mounting flange	RMW			■	
	Installation tool for knurled nut	A-14				■
Removal tool	Removal tool for contact elements	A-DW				■
Multi LED	Multi LED white Ba9S, 24 VDC	LE24/9WS	■	■	■	■
	Multi LED white Ba9S, 230 VDC	LE230/9WS	■	■	■	
Lamp	Lamp 24V/1.9W	L24/9	■		■	

Emergency stop label	Emergency stop label	Emergency stop protective collar
 <ul style="list-style-type: none"> <li>■ NDP-70</li> <li>■ Material V4A</li> <li>■ Yellow powder-coated</li> </ul>	 <ul style="list-style-type: none"> <li>■ MDP-8.2</li> <li>■ EMERGENCY STOP Sign Plastic</li> </ul>	 <ul style="list-style-type: none"> <li>■ EDRR-1 SET</li> <li>■ Aluminium die-cast</li> <li>■ Yellow powder-coated</li> </ul>

Emergency stop protective collar	Protective collar	Selector switch lock
 <ul style="list-style-type: none"> <li>■ NSK/V4A/GB</li> <li>■ Bracket material 1.4550 plate V4A powder-coated</li> </ul>	 <ul style="list-style-type: none"> <li>■ NSK-GR</li> <li>■ Protective collar to prevent accidental touching</li> <li>■ For pushbuttons and illuminated N product portfolio pushbuttons and illuminated pushbuttons</li> <li>■ Command device not included in delivery</li> </ul>	 <ul style="list-style-type: none"> <li>■ NWSP21GR / NWSP32GR</li> <li>■ Replacement measure for key-operated selector switch</li> <li>■ For selector switches with long toggle</li> <li>■ Padlock not included in the delivery</li> </ul>

# Command and signalling devices

## Accessories

<p><b>Blanking plug</b></p>  <ul style="list-style-type: none"> <li>■ NB</li> <li>■ Plastic, metallized</li> <li>■ For installation diameter 22.3 mm</li> </ul>	<p><b>Blanking plug</b></p>  <ul style="list-style-type: none"> <li>■ ABN</li> <li>■ Plastic</li> <li>■ For installation diameter 22.3 mm</li> </ul>	<p><b>Dust shield cap</b></p>  <ul style="list-style-type: none"> <li>■ AMT</li> <li>■ Dust shield cap for lamps and push buttons</li> </ul>
<p><b>Identification label</b></p>  <ul style="list-style-type: none"> <li>■ RZSO2</li> <li>■ Aluminium plate with black anodised labelling area</li> <li>■ Depending on version, 1 to 3 lines can be written</li> </ul>	<p><b>Identification label</b></p>  <ul style="list-style-type: none"> <li>■ NZSO...</li> <li>■ Stainless-steel plate V4A</li> <li>■ Depending on version, 1 to 3 lines can be written</li> </ul>	<p><b>Identification label</b></p>  <ul style="list-style-type: none"> <li>■ MZSO</li> <li>■ Aluminium plate with black anodised labelling area</li> </ul>
<p><b>Identification label</b></p>  <ul style="list-style-type: none"> <li>■ AZSO</li> <li>■ Aluminium plate with black anodised labelling area</li> <li>■ Depending on version, 1 to 2 lines can be written</li> </ul>	<p><b>Adapter ring</b></p>  <ul style="list-style-type: none"> <li>■ RUE</li> <li>■ Plastic</li> <li>■ Adapter ring from installation diameter of 30.5 mm to 22.3 mm</li> </ul>	<p><b>Spare key</b></p>  <ul style="list-style-type: none"> <li>■ SDS1/SDS2 and A-S</li> <li>■ Spare key for key selector switch with EKM locking</li> <li>■ Note: You must state the locking number too</li> </ul>



# Command and signalling devices

## Accessories

<p><b>mounting flange</b></p>  <ul style="list-style-type: none"> <li>■ ELM</li> <li>■ Mounting flange for E and N product portfolio illuminated pushbuttons</li> </ul>	<p><b>mounting flange</b></p>  <ul style="list-style-type: none"> <li>■ EFM</li> <li>■ Mounting flange for E and N product portfolio pushbuttons</li> </ul>	<p><b>mounting flange</b></p>  <ul style="list-style-type: none"> <li>■ RLM</li> <li>■ Mounting flange for R product portfolio with contact carrier and driver</li> </ul>
<p><b>mounting flange</b></p>  <ul style="list-style-type: none"> <li>■ EFMH</li> <li>■ Mounting flange for E and N product portfolio position switches PS116</li> <li>■ Depending on the version, with position switch included in delivery too</li> </ul>	<p><b>Position switches</b></p>  <ul style="list-style-type: none"> <li>■ PS116-....-S200</li> <li>■ Thermoplastic enclosure</li> <li>■ Symmetrical casing</li> <li>■ Protection class IP66, IP67</li> <li>■ Connector plug M12 or cable</li> </ul>	<p><b>Mounting tool</b></p>  <ul style="list-style-type: none"> <li>■ RMW</li> <li>■ Mounting tool for R product portfolio mounting flange</li> </ul>
<p><b>Mounting tool</b></p>  <ul style="list-style-type: none"> <li>■ A-14</li> <li>■ Installation tool for knurled nut</li> </ul>	<p><b>Removal tool</b></p>  <ul style="list-style-type: none"> <li>■ A-DW</li> <li>■ Removal tool for contact elements</li> </ul>	<p><b>Multi LED</b></p>  <ul style="list-style-type: none"> <li>■ LE24/9WS</li> <li>■ LED white</li> <li>■ For Ba9S socket</li> <li>■ 24VAC/DC</li> <li>■ Also available as 230V version</li> </ul>

# Command and signalling devices

## Enclosure for surface mounting

### Enclosure MBGAC/ MBGHAC

The aluminium housings of the MBGAC series enjoy universal application owing to their simple and functional design. They offer the user a high level of sturdiness and a sealing concept that has proven its worth over many years. A special emergency stop enclosure with an integrated protective collar is available in this range that has been coordinated exactly with the emergency stop command devices of product portfolios E and R. This protects the emergency stop from being actuated accidentally and has the advantage for the plant owner of reducing undesirable downtimes.

### Enclosure MBK

MBK enclosures are manufactured from a very high-quality plastic. This makes it possible for the user to use the housings under extreme conditions, such as temperatures from  $-40\text{ }^{\circ}\text{C}$  to  $+100\text{ }^{\circ}\text{C}$ . Furthermore, very few chemicals are capable of causing damage to this plastic. These housings have the glass fibre reinforced plastic to thank for their extreme sturdiness. Users have two knock-out drilled holes available for M20 cable glands to route cables in.

### Enclosure KG

The KG-series features ABS plastic housings for simple applications that do not require the highest level of sturdiness. The cable outlets are already mounted on these enclosures, which means that plant manufacturers only need to mount the command devices.

### Enclosure NBG/ EBG/ EX-EBG

Series NBG / EBG / EX-EBG assembly housings are made of high-quality stainless steel using a special deep-drawing process; they have been specially developed for hygiene and heavy-duty applications. The special ribbed gasket that surrounds the base of the enclosure on which the enclosure cover is forged, makes it possible to implement the particularly high IP 69K protection class. The EX-EBG enclosures have an additional integrated reinforcement panel that exceeds even the extreme requirements for explosion protection.

**MBGHAC**



- Enclosure material, alloy
- For emergency stop with protective collar

**MBGAC**



- Enclosure material, alloy

**MBK**



- Housing material, plastic

**KG**



- Housing material, plastic

**NBG/EBG/EX-EBG**

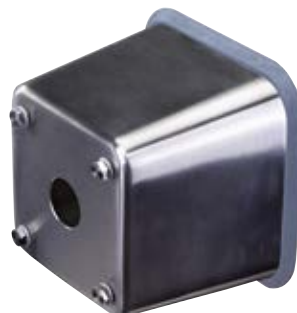

- Enclosure material, stainless steel

## Command and signalling devices

### Enclosure for surface mounting

Type	Description	Housing material	Number of drilled holes	Middle spacing of drilled holes (mm)	Length of enclosure (mm)
<b>MBGAC / MBGHAC</b>	Assembly housing for emergency stop	Alloy	1	–	100
			1	–	100
	Enclosure for surface mounting		1	–	100
			2	40	160
			3	40	200
			4	40	245
			5	40	305
			6	40	305
			2	50	160
			3	50	200
			4	50	245
			5	50	305
			0	–	100
			0	–	160
			0	–	200
			0	–	245
0	–	305			
<b>MBK</b>	Enclosure for surface mounting	Thermoplastic	1	40	85
	Assembly housing for emergency stop		1	40	85
<b>KG</b>	Enclosure for surface mounting	Thermoplastic	1	40	82
			2	40	120
			3	40	160
			2	40	120
			3	40	160
<b>NBG/EBG</b>	Enclosure for surface mounting	Stainless steel	1	–	110
			0	–	154
			0	–	324
			2	60	154
			3	60	154
			4	60	324
			5	60	324
			5	65 / 55 / 55 / 55	324
			Assembly housing for emergency stop	3	54 / 50
	3			54 / 50	154
	Enclosure for surface mounting		1	–	110
			3	60	154
			5	60	324
<b>EX-EBG</b>	Enclosure for surface mounting	Stainless steel	1	–	110
			3	60	154
			5	60	324

Width of enclosure (mm)	Height of enclosure (mm)	Drilled hole for cable gland	Type designation	Recommended command device range		
				"E" program	"N" program	"R" program
100	80	M20	MBGHAC311YE	■		■
100	80	M20	MBGAC311YE	■		■
100	80	M20	MBGAC311	■		■
100	80	M20	MBGAC422	■		■
100	80	M20	MBGAC433	■		■
100	80	M25	MBGAC444	■		■
100	80	M25	MBGAC455	■		■
100	80	M25	MBGAC466	■		■
100	80	M20	MBGAC532	■		■
100	80	M20	MBGAC543	■		■
100	80	M25	MBGAC554	■		■
100	80	M25	MBGAC565	■		■
100	80	-	MBGAC310	■		■
100	80	-	MBGAC420	■		■
100	80	-	MBGAC430	■		■
100	80	-	MBGAC440	■		■
100	80	-	MBGAC450	■		■
85	84	M20	MBK311	■		■
85	84	M20	MBK311GB	■		■
80	85	M20	KG411-A	■		Suitable only to a limited extent
80	85	M20	KG422-A	■		Suitable only to a limited extent
80	85	M20	KG433-B	■		Suitable only to a limited extent
80	85	M20	KG432-A	■		Suitable only to a limited extent
80	85	M20	KG443-A	■		Suitable only to a limited extent
110	88	M20	NBG311	■		Suitable only to a limited extent
110	88	M20	NBG630		■	
110	88	2x M20	NBG660		■	
110	88	M20	NBG632/NM		■	
110	88	M20	NBG633		■	
110	88	2x M20	NBG664/NM		■	
110	88	2x M20	NBG665		■	
110	88	2x M20	NBG665/65.55		■	
110	88	M20	NBG633/54.50/NSK		■	
110	88	M20	NBG633/54.50		■	
110	88	M20	EBG311.O	■	■	■
110	88	M20	EBG633.O	■	■	■
110	88	M20	EBG665.O	■	■	■
110	88	M20	EX-EBG311.O			■
110	88	M25	EX-EBG633.O			■
110	88	2x M25	EX-EBG665.O			■

# Control panels

## Description

### Area of application

Ergonomic operation of the main machine functions at the human-machine interface is a key factor in safety. The control units should be mounted as close as possible to the safety doors so that operators have an overview of the process. BDF Series control units meet this requirement. This series has been designed for mounting onto the commercially available aluminium profile systems of machine enclosures and you can quickly attach them and integrate them in the ambient structure.

### Design and way of functioning

The range is based on a high-quality design with slimline housing made from impact-resistant plastic. Two designs are available to accommodate one or four command devices or indicator lights.

Users can choose from a large product portfolio of illuminated control push buttons, selector switches and selector buttons, LED illuminated indicators, key-operated switches and standards-compliant Emergency-Stop command devices. Positioning of the pushbuttons on the control panel is also freely selectable. Labelling fields allow you to label the functions individually.

This makes it possible for machine builders to use the BDF range to represent the most common operator functions like Emergency Stop, ON / OFF, Forwards / Backwards, Operating Mode Selection, display of operating status conditions or error messages, etc. All the command devices and indicator lights have been developed for industrial applications and have been tried and tested in other series of the command device product portfolio.

The system also includes a mounting plate to combine the control panel with a solenoid interlock and an ergonomic door handle. The BDF 200 AS variant is available to integrate operating devices into the AS Interface Safety at Work (AS-i SaW) communications network.



## Sample application



The photo shows a combination with the BDF200 and an AZM200 solenoid interlock, including a B30 door-handle actuator with the mounting plate as an elegant safety door solution. This positive connection between the BDF200 control panel and the AZM200 solenoid interlock offers machine operators a whole new level of convenience.

# Control panels

## Technical data



■ BDF100...-NH



■ BDF100...

### Key Features

- |   |  |  |
|---|--|--|
| <ul style="list-style-type: none"> <li>• Slim, shock-resistant thermoplastic enclosure</li> <li>• For mounting on commercially available aluminium profile systems</li> </ul> | <ul style="list-style-type: none"> <li>• Emergency stop function with and without protective collar</li> </ul> | <ul style="list-style-type: none"> <li>• Large product portfolio of operating and lighting elements</li> </ul> |
|---|--|--|



### Other versions

ATEX / IECEx	-	-
AS-i SaW	-	-

### Technical features

General description	Control panel with emergency stop	Control panel with one control element
<b>Mechanical data</b>		
Housing material	glass-fibre reinforced thermoplastic, self-extinguishing	glass-fibre reinforced thermoplastic, self-extinguishing
Colour (of cover/enclosure box)	Yellow / Black	Black / Black
Dimensions L x W x H (with connector)		
with protective collar	99 × 40 × 69 mm	-
Without protective collar	99 × 40 × 49 mm	99 × 40 × 49 mm
Connection	Connector plug M12, 8-pole	Connector plug M12, 8-pole
<b>Electrical data</b>		
Rated operating voltage U <sub>e</sub>	24 V	24 V
Thermal test current I <sub>the</sub>	2.5 A	2.5 A
Utilisation category	AC-15: 24 VAC/2 A; DC-13: 24 VDC/1 A	AC-15: 24 VAC/2 A; DC-13: 24 VDC/1 A
Switching of low loads	5 V / 1 mA	5 V / 1 mA
Rated insulation voltage U <sub>i</sub>	60 V	60 V
<b>Circuit versions</b>		
Emergency stop	2 NC contact/1 NO contact	-
Command devices	-	1 NO /1 NC; 2 NO
Emergency stop with indicator lamp	2 NC contact/1 NO contact	-
Command devices with indicator lamp	-	1 NO /1 NC; 2 NO
<b>Ambient conditions</b>		
Ambient temperature	-25 °C ... +65 °C	-25 °C ... +65 °C
Protection class	IP65	IP65

### Safety classification

Standards	EN ISO 13849-1	EN ISO 13849-1
Mechanical life	100,000	1,000,000
B <sub>10d</sub> value	100,000	100,000
Certificates		





■ BDF200-NH-...





■ BDF200...

- Emergency stop function with and without protective collar
- Large product portfolio of operating and lighting elements

- Large product portfolio of operating and lighting elements



-	-
■	■

Control panel with emergency stop and 3 control elements	Control panel with 4 control elements
glass-fibre reinforced thermoplastic, self-extinguishing Yellow / Black	glass-fibre reinforced thermoplastic, self-extinguishing Black / Black
220 × 40 × 69 mm 220 × 40 × 49 mm	- 220 × 40 × 49 mm
M20 cable gland with plug-in terminals	M20 cable gland with plug-in terminals
24 V 2.5 A	24 V 2.5 A
AC-15: 24 VAC/2 A; DC-13: 24 VDC/1 A	AC-15: 24 VAC/2 A; DC-13: 24 VDC/1 A
5 V / 1 mA	5 V / 1 mA
60 V	60 V
2 NC / 1 NO 1 NC / 1 NO; 2 NO	- 1 NC / 1 NO; 2 NO
2 NC contact 1 NO	- 1 NO
-25 °C ... +65 °C	-25 °C ... +65 °C
IP65	IP65



EN ISO 13849-1 1,000,000 (Emergency stop 100,000)	EN ISO 13849-1 1,000,000
100,000	100,000
c  us	c  us

# Control panels

## Actuating elements

Emergency stop pushbutton NH	Emergency stop pushbutton NHK	Pushbutton DT..
 <ul style="list-style-type: none"> <li>■ Mushroom-shaped plastic button, Ø 30 mm</li> <li>■ without protective collar: ordering suffix NH</li> <li>■ Pull to reset</li> <li>■ 1 NO contact / 2 NC contacts</li> </ul>	 <ul style="list-style-type: none"> <li>■ Mushroom-shaped plastic button, Ø 30 mm</li> <li>■ with protective collar: ordering suffix NHK</li> <li>■ Pull to reset</li> <li>■ 1 NO contact / 2 NC contacts</li> </ul>	 <ul style="list-style-type: none"> <li>■ With concave button, button surface 19 × 19 mm</li> <li>■ 2 NO contacts or 1 NO contact / 1 NC contact</li> <li>■ Printing is possible on request</li> <li>■ Refer to the table below for the ordering suffix</li> </ul>

Indicator lights LM..	Emergency-stop pushbutton PT..	Illuminated pushbutton LT..
 <ul style="list-style-type: none"> <li>■ Illuminated surface 19 × 19 mm</li> <li>■ Lamp replacement at the front</li> <li>■ Printing is possible on request</li> <li>■ Refer to the table below for the ordering suffix</li> </ul>	 <ul style="list-style-type: none"> <li>■ Button surface 25 × 25 with rounded edges</li> <li>■ without latching</li> <li>■ 2 NO contacts or 1 NO contact / 1 NC contact</li> <li>■ Printing is possible on request</li> <li>■ Refer to the table below for the ordering suffix</li> </ul>	 <ul style="list-style-type: none"> <li>■ With concave button, button surface 19 × 19 mm</li> <li>■ 2 NO contacts or 1 NO contact / 1 NC contact</li> <li>■ Lamp replacement at the front</li> <li>■ Printing is possible on request</li> <li>■ Refer to the table below for the ordering suffix</li> </ul>

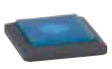
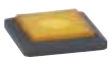
Ordering suffix	yellow	red	green	blue	black	white
 Emergency-stop pushbutton PT..	PTYE	PTRD	PTGN	PTBU	PTBK	PTWH
 Pushbutton DT..	DTYE	DTRD	DTGN	DTBU	DTBK	DTWH
 Illuminated pushbutton LT..	LYE	LTRD	LTGN	LTBU	/	LTWH
 Indicator lights LM..	LMYE	LMRD	LMGN	LMBU		LMWH

For detailed information on selection, visit [www.schmersal.net](http://www.schmersal.net)

# Control panels









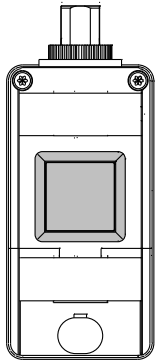

## Actuating elements

Maintained selector switches/ spring-return selector switches		Maintained selector switches/ spring-return selector switches		Key-operated selector switches/buttons	
 <ul style="list-style-type: none"> <li>Version with standard toggle, anthracite</li> <li>Refer to the table below for the ordering suffix</li> </ul>		 <ul style="list-style-type: none"> <li>Version with long toggle, anthracite</li> <li>Refer to the table below for the ordering suffix</li> </ul>		 <ul style="list-style-type: none"> <li>Version with high-quality cylinder lock; therefore, IP65 in this case too</li> <li>Key can be removed in all positions</li> <li>Refer to the table below for the ordering suffix</li> </ul>	
Ordering suffix	Selector switch	Selector switch	Selector switch	Selector switch	Selector switches
					
	1 latched position	2 latched positions to the left/right of the zero position	1 momentary position and automatic return to the zero position	2 touch positions to the left/right of the zero position and automatic return to the zero position	1 momentary position on the right and automatic return to the zero position and 1 maintained position to the left of the zero position
	2 NO or 1 NO / 1 NC	1 NO per position or 1 NC (position 1) / 1 NO (position 2)	2 NO or 1 NO / 1 NC	1 NO per position or 1 NC (position 1) / 1 NO (position 2)	1 NO per position or 1 NC (position 1) / 1 NO (position 2)
 Standard toggle	<b>WS20</b>	<b>WS30</b>	<b>WT20</b>	<b>WT30</b>	<b>WTS30</b>
 Long toggle	<b>WS21</b>	<b>WS31</b>	<b>WT21</b>	<b>WT31</b>	<b>WTS31</b>
 Key-operated switch	<b>SWS20</b>		<b>SWT20</b>		

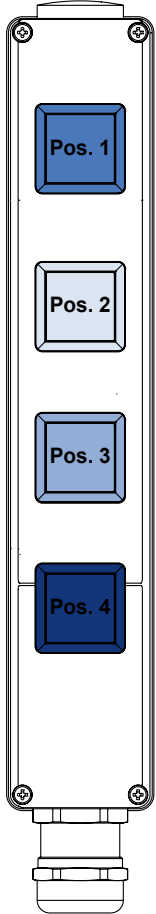
For detailed information on selection, visit [www.schmersal.net](http://www.schmersal.net)

# Control panels



## Combination options

Actuating elements		BDF100 with	BDF200				Control panels
			at pos. 1	at pos. 2	at pos. 3	at pos. 4	
	NH	•	•				<b>BDF100</b> 
	NHK	•	•				
	PT..		•	•	•	•	
	DT..	•	•	•	•	•	<b>BDF200</b> 
	LT..	•	•*	•	•	•	
	LM..		•*	•	•	•	
	SW.20	•		•	•		
	W..0	•		•	•		
	W..1	•		•	•		

\* Not possible in combination with contact version 10.

## Control panels

### Preferred types<sup>1)</sup> and accessories

Series	Fitting at pos. 1	at pos. 2	at pos. 3	at pos. 4	Indicator lamp	Type designation	Material number
<b>BDF100</b> 	NH	–	–	–	–	BDF100-NH-G-ST	101215862
	NHK	–	–	–		BDF100-NHK-G-ST	101211974
	LTBU	–	–	–		BDF100-11-LTBU-ST	101216402
	LTGN	–	–	–		BDF100-11-LTGN-ST	101216247
	SWS20	–	–	–	BDF100-11-SWS20-ST	101217193	
	WS20	–	–	–	green	BDF100-11-WS20-G/GN-ST	103001068
	LTBU	–	–	–	–	BDF100-20-LTBU-ST	101217770
	LTGN	–	–	–	–	BDF100-20-LTGN-ST	101217217
<b>BDF200</b> 	NH	LTGN	LTGN	LTYE	red	BDF200-NH-10-LTGN-LTGN-LMYE-G24	103000487
		LTYE	SWS20	LTBU		BDF200-NH-10-LTYE-SWS20-LTBU-G24	103000657
		LTBU	LTRD	LTGN	–	BDF200-NHK-20-LTGN-LTBU-LTRD	101212033
		SWS20	LTGN	LTRD		BDF200-NHK-20-LTGN-LTBU-LTRD	101212023
		LT	LT	LT		BDF200-NH-10-LT-LT-LT-G24-2875	103007781
		LT	LT	LT		BDF200-NH-11-LT-LT-LT-2875	103007782
		LT	LT	LT		BDF200-NH-20-LT-LT-LT-2875	103007783
		SWS20	LT	LT		BDF200-NH-11-SWS20-LT-LT-2875	103007789
	SWS20	LT	LT	BDF200-NH-20-SWS20-LT-LT-2875	103007790		
	NHK	WT30	DTRD	DTGN	–	BDF200-NHK-11-WT30-DTRD-DTGN	101212034
		LTGN	LTBU	LTRD		BDF200-NHK-20-LTGN-LTBU-LTRD	101211180
		LT	LT	LT		BDF200-NHK-10-LT-LT-LT-G24-2875	103007784
		LT	LT	LT		BDF200-NHK-11-LT-LT-LT-2875	103007785
		LT	LT	LT		BDF200-NHK-20-LT-LT-LT-2875	103007786
		SWS20	LT	LT		BDF200-NHK-11-SWS20-LT-LT-2875	103007791
	LT	SWS20	LT	LT	–	BDF200-NHK-20-SWS20-LT-LT-2875	103007792
		LT	LT	LT		BDF200-LT-11-LT-LT-LT-2875	103007787
		LT	LT	LT	–	BDF200-LT-20-LT-LT-LT-2875	103007788

AZM 200	MP BDF 200	101214126
 <ul style="list-style-type: none"> <li>Can be combined with the AZM200 solenoid interlock</li> <li>For more information, visit <a href="http://www.schmersal.net">www.schmersal.net</a></li> </ul>	 <ul style="list-style-type: none"> <li>Mounting plate for combination of AZM200 solenoid interlock with -B30 actuator and BDF200 control panel</li> </ul>	

<sup>1)</sup> The preferred types designate the choice of devices with faster delivery times.

Type designation **-2875**: the coloured button caps are included in the scope of delivery as an accessory pack for customers to mount themselves.

To see a wide range of other types, visit [www.schmersal.net](http://www.schmersal.net)

# Two-hand control panels

## Description

### Area of application

The job of two-hand controls or two-hand control panels is to ensure that the machine operators hands are located on the control panel when they issue the control signal for a hazardous movement. This prevents operators from reaching into the danger area after starting the machine or process.

The main areas of application for two-hand controls are presses and stamping units in the metal processing or powder metallurgy industries as well as similar machines and systems that involve manual insertion and removal operations. These include printing and paper processing machines, rubber and plastics processing machines, machines involved in the chemical industry and assembly plants.

### Design and way of functioning

Two-hand control panels are designed as such so the operators need both hands at the same time to start a hazardous movement. This forces operators to keep their hands in the same place which means that they cannot reach into the danger zone while the system is carrying out the hazardous movement.

All Schmersal Group two-hand control panels are fitted with an Emergency Stop button that complies with EN ISO 13850. Apart from this, there are guard hoods over the operating elements, which prevent people from circumventing the protection function using their hands, elbows, stomach, hips, thighs or knees, for example. It is also not possible to operate from the back of the control panels.



The devices comply with the requirements of EN 574, which, amongst other things, specifies the spacing of the controls. Users can choose between different versions that differ, amongst other things, by virtue of the material of the enclosure (plastic and die-cast aluminium). In the central part of the folding enclosure, it is possible to mount up to eight additional command and signalling devices.

Accessories include, amongst other things, various stand versions. Combined with the PROTECT SRB 201 ZH safety-monitoring module, it is possible to integrate two-hand control panels into the machine controller.

## Wide selection of mounting posts

You can find appropriate mounting posts and other accessories on page 108 and in our online catalogue at [www.schmersal.net](http://www.schmersal.net).



# Two-hand control panels

## Technical data



SEP-K02

SEP-G05

### Key Features

- Plastic enclosure
- Control panel with 8 additional drilled holes that you can knock out if required
- 2-piece enclosure for simple and favourable assembly

- Die-cast aluminium enclosure
- Control panel suitable for mounting a minimum of 8 additional command and signalling devices
- Easy assembly thanks to 2-piece folding enclosure
- Ergonomic operation due to wrist support
- Terminal strips and relay assembly possible in the interior

### Technical features

<b>General description</b>	Two-hand control panel	Two-hand control panel
<b>Mechanical data</b>		
<b>Housing material</b>	Thermoplastic	Die-cast aluminium
<b>Colour</b>	RAL 7035 (tinted)	RAL 7035 (powder-coated)
<b>Dimensions (L x W x H)</b>	469 × 137 × 185 mm	494 × 160 × 184 mm
<b>Possible fastening</b>		
<b>On mounting post</b>	Yes	Yes
<b>Directly on the machine or wall</b>	Yes	Yes
<b>Command positions</b>		
<b>Number of drilled holes</b>	3	3
<b>Optional possible command positions</b>	8	8
<b>Ø of drilled hole</b>	22.3 mm	22.3 mm
<b>Electrical data</b>	Depends on the pre-mounted command device	Depends on the pre-mounted command device
<b>Ambient conditions</b>		
<b>IP Protection class</b>	IP54	IP54

### Safety classification

<b>Standards</b>	IEC 60947-5-1; IEC 60947-1; IEC 60947-5-5; EN ISO 13850; EN 574	IEC 60947-5-1; IEC 60947-1; IEC 60947-5-5; EN ISO 13850; EN 574
<b>Certificates</b>	-	-

We recommend using our SRB safety-monitoring module to monitor two-hand control panels.

You can also find appropriate mounting posts, command devices and other accessories in our online catalogue at [www.schmersal.net](http://www.schmersal.net).





## SEP09

- Aluminium enclosure
- For separate assembly of the controls for two-hand control
- Specify on user side spacing according to EN 574

Two-hand control

Aluminium

RAL 7035 (powder-coated)

155 × 150 × 160 mm  
(per operating element)

No

Yes

1 per operating element

-

22.3 mm

Depends on the  
pre-mounted command device

IP54

IEC 60947-5-1; IEC 60947-1;  
IEC 60947-5-5;  
EN ISO 13850; EN 574







-

## Two-hand control panels

### Preferred types <sup>1)</sup>

Series	Enclosure	Description	Controls	Head Ø	Contacts	
SEPK02	Thermoplastic	2-piece enclosure with 8 additional drilled holes that you can knock out if required	ADP55.3SW		55 mm	1 NO / 1 NC
			ADP55.3SW/O.F			
			Empty enclosure			
SEPG05	Metal	2-part enclosure suitable for mounting a minimum of 8 additional command and signalling devices	EDP42SW		42 mm	1 NO / 1 NC
			EDP55SW		55 mm	1 NO / 1 NC
			ADP55.3SW		55 mm	1 NO / 1 NC
			Empty enclosure			
SEPO9	Metal	For separate assembly of the controls for two-hand control with detachable aluminium cover on the bottom	EDP55SW		55 mm	1 NO / 1 NC
			EDP42SW		42 mm	1 NO / 1 NC
			Empty enclosure			

<sup>1)</sup> The preferred types designate the choice of devices with faster delivery times.

Emergency stop		Head Ø	Contacts	Type designation	Material number
ADRR40RT		40 mm	1 NO / 1 NC	SEPK02.0.4.0.22/95	101027371
				SEPK02.0.4.0.22/95.E2	101211126
				SEPK02.0.L.22	101027369
EDRR40RT		40 mm	1 NO / 1 NC	SEPG05.3.3.0.22/95	101172764
EDRR50RT		50 mm	1 NO / 1 NC	SEPG05.3.2.0.22/95	101172762
EDRR40RT		40 mm	1 NO / 1 NC	SEPG05.3.4.0.22/95	101172765
EDRR50RT		50 mm	1 NO / 1 NC	SEPG05.3.1.0.22/95	101172760
EDRR40RT		40 mm	1 NO / 1 NC	SEPG05.3.4.0.22/95.E1	101210845
				SEPG05.3.L.22	101172767
-		-	-	SEP09.0.1.0.22/95	101022849
-		-	-	SEP09.0.3.0.22/95	101022851
				SEP09.0.L.22	101022856

## Two-hand control panels

### Mounting post

STPLC1	101024774	STP 02.1.1	101022865	STP 02.4.1	101022867
 <ul style="list-style-type: none"> <li>■ Welded structure with base-fastening tapped holes</li> <li>■ Without height adjustment, without distance ring</li> <li>■ Can be combined with SEP ... control panel for use as a two-hand foot operating station</li> </ul>		 <ul style="list-style-type: none"> <li>■ Welded structure with base-fastening tapped holes</li> <li>■ With height adjustment</li> <li>■ Without distance ring</li> </ul>		 <ul style="list-style-type: none"> <li>■ Welded structure with base-fastening tapped holes</li> <li>■ With height adjustment</li> <li>■ With distance ring</li> </ul>	

## Recommended evaluations

SRB-E-201ST	SRB-E-402ST			
 <ul style="list-style-type: none"> <li>■ Monitoring two-hand control panels to EN 574 IIIC</li> <li>■ Function STOP 0</li> <li>■ 1- or 2-channel control</li> <li>■ Start button / autostart</li> <li>■ 2 safety outputs 5.5 A</li> <li>■ 1 signalling output</li> <li>■ For more information, visit <a href="http://www.schmersal.net">www.schmersal.net</a></li> </ul>			 <ul style="list-style-type: none"> <li>■ Monitoring two-hand control panels to EN 574 IIIC</li> <li>■ 2x function STOP 0</li> <li>■ 2x 1- or 2-channel control</li> <li>■ 2x start button / autostart</li> <li>■ 2 safety contacts</li> <li>■ 2 safety outputs</li> <li>■ For more information, visit <a href="http://www.schmersal.net">www.schmersal.net</a></li> </ul>	

For detailed information on selection, visit [www.schmersal.net](http://www.schmersal.net)

**tec.nicum**

Your partner for machine safety and workplace protection

tec.nicum is the new service division of the Schmersal Group. It offers machine manufacturers, machine operators and distributors competent advice with product and manufacturer neutrality.

tec.nicum supports its clients in the reliable design of machines and workplaces.  
The tec.nicum team drafts and realises safety solutions across all lifecycle stages of the machine.

The new range of services:



**tec.nicum academy**  
Seminars and training



**tec.nicum consulting**  
Consultancy services



**tec.nicum engineering**  
Design, planning and  
PLC programming



**tec.nicum integration**  
Execution and installation



For detailed information, check out  
**[www.tecnicum.com](http://www.tecnicum.com)**

# Maintained joystick switches and spring-return joystick switches

## Description

### Area of application

Extremely robust, compact, versatile and functional: These properties make MK/WK series joystick buttons and switches highly suitable for use on machinery and plants in the food-processing and process technology industries.

Furthermore, they are suitable for especially harsh industrial applications, including outdoor usage. Compared with multifunctional command systems, such as those used on the control units for cranes and automated guided vehicles (AGV), they need considerably less installation space.

### Design and way of functioning

Users can choose between three designs:

- Maintained joystick switch, reset by touch and spring force
- Spring-return joystick switch, reset by spring force
- Maintained and spring-return joystick switch, reset by touch and spring force

All the designs are available with up to four switch positions/actuating directions.

This means that the joystick switches and buttons make the HMI easier: It is possible to actuate different machine functions with a single, compact piece of robust switchgear.

The joystick switches and buttons are available in a wide range of different contact variants with up to eight galvanically isolated contacts as well as in protection classes IP65, IP67 and IP69K. We can also supply versions for outdoor applications that are suitable for temperatures of  $-25\text{ °C}$  to  $+80\text{ °C}$ . If you want protection from accidental actuation from the zero position, it is possible to fit the operating devices with a mechanical lock.

The contact system in series MK and WK works on the tried and tested four-way contact ("H bridge") principle that is extremely shock- and jolt-resistant.



## Operating principle

**Spring-return joystick switch**  
Spring-return switching position (touch position)  
Reset by spring force

**Maintained joystick switch**  
Maintained switching positions (latched position)  
Reset by touch and spring force

**Maintained/spring-return joystick switch**  
Switching position spring-return and maintained  
Reset by touch and spring force



### Locking sleeve

All devices are available with an additional mechanical lock as a protection against accidental shifts out of the home position. The holding force of the lock is approx. 100 N for devices with an installation diameter of 22.3 mm and approx. 200 N for devices with an installation diameter of 30.5 mm.



# Maintained joystick switches and spring-return joystick switches

## Technical data



■ MKT



■ MKS

### Key Features

- Mounting hole Ø 22.3 mm
- Spring-return joystick switch

- Mounting hole Ø 22.3 mm
- Maintained joystick switch

### Technical features

<b>Mechanical data</b>		
Length of actuator	77 mm	77 mm
Material of the front ring	Al anodised	Al anodised
Fixing	Lock nut	Lock nut
Mounting hole	22.3 mm	22.3 mm
Installation depth	Depending on contact type	Depending on contact type
Front plate thickness	1.5 mm ... 6 mm	1.5 mm ... 6 mm
Spacing	80 × 80 mm	80 × 80 mm
Actuating force	approx. 11 N	approx. 11 N
Momentary position	To left and right of zero position	–
Latched position	–	To left and right of zero position
Resistance to shock	110 g/4 ms – 30 g/18 ms, no bouncing	110 g/4 ms – 30 g/18 ms, no bouncing
Resistance to vibrations	> 20 g/10 ... 200 Hz	> 20 g/10 ... 200 Hz
Switching frequency	1,200 s/h	1,200 s/h
Switching principle	Creep circuit element	Creep circuit element
Execution of the electrical connection	Screw terminals	Screw terminals
Cable section:	0.5 mm <sup>2</sup> ... 2.5 mm <sup>2</sup>	0.5 mm <sup>2</sup> ... 2.5 mm <sup>2</sup>
<b>Electrical data</b>		
Rated impulse withstand voltage $U_{imp}$	4 kV	4 kV
Rated insulation voltage $U_i$	400 V	400 V
Thermal test current $I_{the}$	10 A	10 A
Max. fuse rating	10 A gG D-fuse	10 A gG D-fuse
Utilisation category	AC-15: 250 VAC/8 A; DC-13: 24 VDC/5 A	AC-15: 250 VAC/8 A; DC-13: 24 VDC/5 A
<b>Ambient conditions</b>		
Ambient temperature	–25 °C ... +80 °C	–25 °C ... +80 °C
Protection class	IP65 / IP67 to IEC 60529	IP65 / IP67 to IEC 60529

### Safety classification

Standards	IEC 60947-5-1, IEC 60947-1	IEC 60947-5-1, IEC 60947-1
Mechanical life	1,000,000	1,000,000
$B_{10d}$ value	100,000	100,000





■ WKT



■ WKS

- Mounting hole Ø 30.5 mm
- Spring-return joystick switch

- Mounting hole Ø 30.5 mm
- Maintained joystick switch

90 mm	90 mm
Al anodised	Al anodised
mounting flange	mounting flange
30.5 mm	30.5 mm
Depending on contact type	Depending on contact type
1.5 mm ... 10 mm	1.5 mm ... 10 mm
80 × 80 mm	80 × 80 mm
approx. 11 N	approx. 11 N
To left and right of zero position	–
–	To left and right of zero position
110 g/4 ms – 30 g/18 ms, no bouncing	110 g/4 ms – 30 g/18 ms, no bouncing
> 20 g/10 ... 200 Hz	> 20 g/10 ... 200 Hz
1,200 s/h	1,200 s/h
Creep circuit element	Creep circuit element
Screw terminals	Screw terminals
0.5 mm <sup>2</sup> ... 2.5 mm <sup>2</sup>	0.5 mm <sup>2</sup> ... 2.5 mm <sup>2</sup>
4 kV	4 kV
400 V	400 V
10 A	10 A
10 A gG D-fuse	10 A gG D-fuse
AC-15: 250 VAC/8 A; DC-13: 24 VDC/5 A	AC-15: 250 VAC/8 A; DC-13: 24 VDC/5 A
–25 °C ... +80 °C	–25 °C ... +80 °C
IP65 / IP67 to IEC 60529	IP65 / IP67 to IEC 60529
IEC 60947-5-1, IEC 60947-1	IEC 60947-5-1, IEC 60947-1
1,000,000	1,000,000
100,000	100,000

# Maintained joystick switches and spring-return joystick switches

## Selection aid

### 1<sup>st</sup> step: Selection of the device design

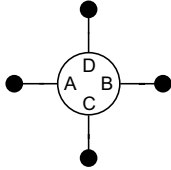
Choice of device	Contact variants				Spring-return joystick switch			
	Position	Position	Position	Position	Range MKT Mounting-Ø 22.3 mm		Range WKT Mounting-Ø 30.5 mm	
	A	B	C	D	without locking sleeve	with locking sleeve	without locking sleeve	with locking sleeve
	1 NO	1 NO			MKTA32	MKTA321	WKTA32	WKTA321
	1 NC	1 NC			MKTA32/401	MKTA321/401	WKTA32/401	WKTA321/401
	2 NO	2 NO			MKTB32	MKTB321	WKTB32	WKTB321
	1 NC/1 NO	1 NC/1 NO			MKTB32/1x401	MKTB321/1x401	WKTB32/1x401	WKTB321/1x401
	2 NO	2 NO			MKTC32	MKTC321	WKTC32	WKTC321
	1 NO	1 NO	1 NO		MKTC42	MKTC421	WKTC42	WKTC421
	1 NO	1 NO	1 NO	1 NO	MKTC52	MKTC521	WKTC52	WKTC521
	1 NC	1 NC	1 NC	1 NC	MKTC52/2x401	MKTC521/2x401	WKTC52/2x401	WKTC521/2x401
	4 NO	4 NO			MKTE32	MKTE321	WKTE32	WKTE321
	4 NC	4 NO			MKTE32/404	MKTE321/404	WKTE32/404	WKTE321/404
	4 NC	4 NC			MKTE32/800	MKTE321/800	WKTE32/800	WKTE321/800
	2 NO	2 NO	2 NO	2 NO	MKTE52	MKTE521	WKTE52	WKTE521
	1 NC/1 NO	1 NC/1 NO	2 NO	2 NO	MKTE52/206	MKTE521/206	WKTE52/206	WKTE521/206
	2 NC	2 NO	2 NO	2 NO	MKTE52/206.1	MKTE521/206.1	WKTE52/206.1	WKTE521/206.1
	1 NC/1 NO	1 NC/1 NO	1 NC/1 NO	1 NC/1 NO	MKTE52/2x401	MKTE521/2x401	WKTE52/2x401	WKTE521/2x401

### 2<sup>nd</sup> step: Selection of the bellows

Bellows	Standard	/WKT-19.4	/WKT-19.3	/WKT-26
<b>Description</b>	Bellows rubber	Bellows rubber, suitable for outdoor usage	Silicone bellows, UV-resistant up to -40°C	Silicone bellows, UV-resistant up to -40°C thick-walled / tear-proof IP69K
<b>Material thickness</b>	approx. 1 mm			approx. 2 mm
<b>Material features</b>	tear-proof		partly tear-proof	tear-proof
<b>Protection class (frontside)</b>	IP65 / IP67			IP67 / IP69K
<b>Ambient temperature</b>	-25 °C ... +80 °C		-40 °C ... +80 °C	
<b>Mechanical life</b>	1,000,000	500,000	300,000	500,000
<b>Notes</b>	–	–	–	Only usable in combination with spring-return joystick switches without locking sleeve
<b>Material resistance</b>	Rubber		Silicone	
– UV/ozone	not suitable	suitable	particularly suitable	
– Outdoor usage	not suitable	suitable	particularly suitable	
– Fuel, oil	partly suitable		not suitable	
– Solvents	partly suitable		partly suitable	
– Acids	partly suitable		not suitable	
– Chemicals	not suitable		partly suitable	
– Foodstuff	not suitable		physiologically harmless	

#### Optional bellows

To order, the order code of the bellows is added to the order code of the switch.

Maintained joystick switch				Maintained/spring-return	
Range MKS Mounting-Ø 22.3 mm		Range WKS Mounting-Ø 30.5 mm		Range WKTS Mounting-Ø 30.5 mm	
without locking sleeve	with locking sleeve	without locking sleeve	with locking sleeve	without locking sleeve	with locking sleeve

MKSA32	MKSA321	WKSA32	WKSA321	WKTSA32 <sup>1)</sup>	WKTSA321 <sup>1)</sup>
MKSA32/401	MKSA321/401	WKSA32/401	WKSA321/401		
MKSB32	MKSB321	WKSB32	WKSB321		
MKSB32/1x401	MKSB321/1x401	WKSB32/1x401	WKSB321/1x401		
MKSC32	MKSC321	WKSC32	WKSC321		
MKSC42	MKSC421	WKSC42	WKSC421		
MKSC52	MKSC521	WKSC52	WKSC521	WKTSC52 <sup>2)</sup>	WKTSC521 <sup>2)</sup>
MKSC52/2x401	MKSC521/2x401	WKSC52/2x401	WKSC521/2x401		
MKSE32	MKSE321	WKSE32	WKSE321		
MKSE32/404	MKSE321/404	WKSE32/404	WKSE321/404		
MKSE32/800	MKSE321/800	WKSE32/800	WKSE321/800		
MKSE52	MKSE521	WKSE52	WKSE521		
MKSE52/206	MKSE521/206	WKSE52/206	WKSE521/206		
MKSE52/206.1	MKSE521/206.1	WKSE52/206.1	WKSE521/206.1		
MKSE52/2x401	MKSE521/2x401	WKSE52/2x401	WKSE521/2x401		

<sup>1)</sup> Position A spring-return (touch position) and Position B maintained (latched position)

<sup>2)</sup> Position C/D spring-return (touch position) and Position A/B maintained (latched position)

### 3<sup>rd</sup> step: Your product

Type designation				
Mounting hole 22,3 mm	M			
Spring-return joystick switch		KT		
Contacts 4 NO contacts Position A 4 NO contacts Position B			E32	
With locking sleeve				1
Bellows suitable for outdoor usage				/WKT-19.4
	<b>MKTE321/WKT-19.4</b>			

# Maintained joystick switches and spring-return joystick switches

## Preferred types <sup>1)</sup>

Mounting-Ø	Type	With locking sleeve	Installation depth	Contact variants				Type designation	Material number	
				Position A	Position B	Position C	Position D			
22.3 mm	Maintained joystick switch	–	70 mm	1 NO	1 NO	–	–	MKSA32	101005813	
		■						MKSA321	101005816	
		–	104 mm	2 NO	2 NO	–	–	MKSB32	101203907	
		■						MKSB321/WKT-19.3	101191939	
		–	70 mm	1 NO	1 NO	1 NO	1 NO	MKSC32	101005817	
		■						MKSC321	101005818	
		–						MKSC52	101005821	
		■						MKSC521	101005822	
		–	112 mm	2 NO	2 NO	2 NO	2 NO	MKSE52/WKT-19.4	101190916	
	■	MKSE521						101005826		
	Spring-return joystick switch	70 mm	–	1 NO	1 NO	–	–	MKTA32	101005827	
			■					MKTA321	101005829	
			–	2 NO	2 NO	–	–	MKTB32	101005828	
			■					MKTB321	101194681	
			–	70 mm	1 NO	1 NO	1 NO	1 NO	MKTC32	101005832
			■						MKTC321	101005835
		–	MKTC52						101005837	
		■	MKTC521						101005844	
–		112 mm	4 NO	4 NO	–	–	MKTE321	101190067		
■							MKTE52	101005842		
30.5 mm		Maintained joystick switch	–	57 mm	1 NO	1 NO	–	–	WKSA32	101019540
			■						WKSA321	101019545
	–		2 NO		2 NO	–	–	WKSC32	101019465	
	■							WKSC321	101019493	
	–		70 mm		1 NO	1 NO	1 NO	1 NO	WKSC52	101019467
	■								WKSC521	101019473
	–	91 mm	2 NO	2 NO	2 NO	2 NO	WKSE52	101019489		
	■						WKSE521	101019492		
	Spring-return joystick switch	57 mm	–	1 NO	1 NO	–	–	WKTA32	101007593	
			■					WKTA321	101019509	
		–	91 mm	2 NO	2 NO	–	–	WKTB32	101019514	
		■						WKTB321	101019539	
		–						WKTC32	101007594	
		■						WKTC321	101007595	
		–	57 mm	1 NO	1 NO	1 NO	1 NO	WKTC52	101007597	
		■						WKTC521	101019447	
		–	91 mm	2 NO	2 NO	2 NO	2 NO	WKTE52	101019461	
		■						WKTE521	101019464	

Schematic representation of positions A-D

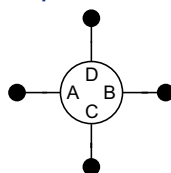

<sup>1)</sup> The preferred types designate the choice of devices with faster delivery times. To see a wide range of other types, visit [www.schmersal.net](http://www.schmersal.net)

# Maintained joystick switches and spring-return joystick switches

## Dimensions

Range MK...		2 contacts	4 contacts	4 contacts	8 contacts
Mounting- $\varnothing$ 22.3 mm					
without locking sleeve		MKTA32...	MKTB32...	MKTC32...	MKTE32...
		MKSA32...	MKSB32...	MKSC32...	MKSE32...
				MKTC42...	MKTE52...
				MKSC42...	MKSE52...
				MKTC52...	
		MKSC52...			
with locking sleeve		MKTA321...	MKTB321...	MKTC321...	MKTE321...
		MKSA321...	MKSB321...	MKSC321...	MKSE321...
				MKTC421...	MKTE521...
				MKSC421...	MKSE521...
				MKTC521...	
		MKSC521...			

MP = Mounting plate (Series MK... Max. thickness 6 mm)

Range WK...		2 contacts	4 contacts	4 contacts	8 contacts
Mounting- $\varnothing$ 30.5 mm					
without locking sleeve		WKTA32...	WKTB32...	WKTC32...	WKTE32...
		WKSA32...	WKS32...	WKSC32...	WKSE32...
		WKTA321...	WKTB321...	WKTC42...	WKTE52...
				WKSC42...	WKSE52...
				WKTC52...	
		WKSC52...			
		WKTC52...			
with locking sleeve		WKTA321...	WKTB321...	WKTC321...	WKTE321...
		WKSA321...	WKS321...	WKSC321...	WKSE321...
		WKTA321...	WKTB321...	WKTC421...	WKTE521...
				WKSC421...	WKSE521...
				WKTC521...	
		WKSC521...			
		WKTC521...			

MP = Mounting plate (Series WK... Max. thickness 10 mm)

# Enabling switches

## Description

### Area of application

When carrying out set-up, refitting or service work on plant or machinery, it can be beneficial to partially or completely deactivate guard systems. Typically, this includes setting up a machine (set-up mode) and monitoring machining procedures (process monitoring).

One example: The operator of a machine tool is able to check format settings better and program movements more exactly if the safety door is open. The better view of the process makes operation more convenient and reduces set-up and refitting times.

Special safety measures are needed for this case and similar ones; these measures are referred to as special operating modes and are specified in the machine directive and in some type C standards.

The measures that are required in this case include enabling devices that operators must actuate to start up the respective machine functions. In many cases, this is a slowed-down machine movement. The effect of the guard system is only partially or entirely suspended for the time in which the operator presses the enabling device.

---

### Design and way of functioning

Operators must put the enabling device into the centre position and hold it in this position. As soon as they release the button or press it all the way down, the system interrupts the control command on a safety-related basis.

Series ZSD5 and ZSD6 enabling devices are of ergonomic design; with series ZSD6, an additional pushbutton is integrated in the device head. Operators can select the optimum position to the machine or the process; the connection to the machine controller is guaranteed by a signal line.

Both series are suitable for robot applications in accordance with ANSI standards. There are of course suitable safety relay modules available for signal evaluation.



## Permissible speeds in enabling mode

It is controversial and standards deal differently with the question of what "reduced" speeds are justifiable in enabling mode to comply with the further condition of the machine directive (see Machine Directive Appendix I, Clause 1.2.5) that the operation of dangerous functions is only possible under minor risk conditions (= reduced speed, reduced power, step mode, etc.)

Consideration should be given to specific C-standard specifications for the individual application.

Otherwise, it is advisable to differentiate between crushing and shearing hazards on the one hand and "just" collision hazards on the other. In this connection, people frequently quote values of 33 mm/sec. (2 m/min.) max. in the case of crushing and shearing hazards and 250 mm/sec. (15 m/min.) max. in the case of collision hazards <sup>1)</sup>. MRL 2006/42/EG, however, "permits" higher values if absolutely technically necessary and execution is integrated into a considered and coherent safety concept <sup>2) 3)</sup>.

A reduction in speed (performance, movement etc.) can be controlled either via the operating controller or via a safety-related controller or monitoring system, e.g. Safety Limited Speed (SLS) or similar in accordance with EN/IEC 61800-5-2.

In this case too, we refer you to the "responsible standards": to some extent, it is adequate to use just enabling devices for minor risks with a safe controller or monitoring system only being required above and beyond this, to some extent there is, however, a general requirement for "enabling devices + SLS", for example).

Technology is developing in the direction of "+ e.g. "SLS" (i.e. "safe controllers or monitoring systems"). Drives and drive controllers with integrated safety functions of this kind are being found far more frequently on the market. Where these possibilities cannot be implemented owing to reasons of technology and/or costs, consideration should be given to whether pressing the enabling device from stage 2 to stage 3 leads to an acceptably safe operating condition for the user or not, while also taking account of the machine's reaction time (delay from signaling to stationary or uncritical speed) as well as an additional human response time, such as 1 second.

<sup>1)</sup> You can find an overview of the maximum speeds that there are for manual intervention on running machines in the IFA Manual (loose leaf collection – Lfg. 2/11 – XII/2011 – Clause 330 216).

<sup>2)</sup> See Machine Directive Appendix I, Clause 1.2.5: If it is not possible to comply with these requirements at the same time, the (mode selector switch) must trigger other protective measures ..., such as a safe working area is guaranteed.

<sup>3)</sup> See also specialist committee information sheet 002 of specialist committee MFS of DGUV Wood and Metal Professional Association, Mainz, Process Monitoring on the Shopfloor.

# Enabling switches

## Technical data



■ ZSD 5



■ ZSD 6

### Key Features

- 3-stage grip switch OFF-ON-OFF
- Contacts do not close on resetting from stage 3 → stage 1

- 3-stage grip switch OFF-ON-OFF
- Contacts do not close on resetting from stage 3 → stage 1
- With additional pushbutton

### Technical features

<b>Mechanical data</b>		
Housing material	Plastic, thermoplastic, self-extinguishing	Plastic, thermoplastic, self-extinguishing
Additional pushbutton in device head	No	Yes
Number of NO contacts	2	3
With positive break (stages 2-3)	2	2
Number of NC contacts	1	1
Switching frequency	max. 1200/h	max. 1200/h
Cable section:	0.14 mm <sup>2</sup> ... 1.5 mm <sup>2</sup>	0.14 mm <sup>2</sup> ... 1.5 mm <sup>2</sup>
Connection	Screw terminals	Screw terminals
<b>Electrical data</b>		
Rated operating voltage U <sub>e</sub>	250 V	250 V
Operating current I <sub>e</sub>	3 A	3 A
Utilisation category NO contacts	AC-15: 125 V / 1.5 A; 250 V / 0.75 A; DC-13: 30 V / 1.0 A; 125 V / 0.22 A; 250 V / 0.1 A	AC-15: 125 V / 1.5 A; 250 V / 0.75 A; DC-13: 30 V / 1.0 A; 125 V / 0.22 A; 250 V / 0.1 A
Auxiliary contacts	AC-15: 125 V / 1.5 A; 250 V / 0.75 A; DC-13: 30 V / 2.3 A; 125 V / 0.22 A; 250 V / 0.1 A	AC-15: 125 V / 1.5 A; 250 V / 0.75 A; DC-13: 30 V / 2.3 A; 125 V / 0.22 A; 250 V / 0.1 A
Additional pushbutton	–	AC-15: 125 V / 0.3 A; DC-13: 30 V / 0.7 A; 125 V / 0.1 A
<b>Ambient conditions</b>		
Ambient temperature	–10 °C ... +60 °C	–10 °C ... +60 °C
Protection class IP	IP65	IP65

### Safety classification

Standards	ISO 13849-1, IEC 61508	ISO 13849-1, IEC 61508
Mechanical life	Stage 1-2-1: min. 1,000,000; Stage 1-2-3-1: min. 100,000	Stage 1-2-1: min. 1,000,000; Stage 1-2-3-1: min. 100,000
B <sub>10d</sub> value	100,000	100,000
Certificates		



## Enabling switches

### Ordering details and recommended evaluations

Type	Description	Connecting cable	Type designation	Material number
Enabling switches	3-stage grip switch	Without	ZSD5/O.LTG	101199467
		5 m	ZSD5/5M	101199469
	3-stage grip switch with additional pushbutton in device head	Without	ZSD6/O.LTG	101199480
		5 m	ZSD6/5M	101210087
Accessories	Mounting angle made of metal		ZSD-H	101163725

### Recommended evaluations

PROTECT SELECT	SRB-E-301ST	SRB-E-201LC
 <ul style="list-style-type: none"> <li>■ Evaluation of enabling devices</li> <li>■ STOP 0 or STOP 1, depending on the setting values in the application program</li> <li>■ For more information, visit <a href="http://www.schmersal.net">www.schmersal.net</a></li> </ul>	 <ul style="list-style-type: none"> <li>■ Function STOP 0</li> <li>■ 1- or 2-channel control</li> <li>■ Start button / autostart</li> <li>■ 3 safe relay outputs 6 A</li> <li>■ 1 signalling output</li> <li>■ For more information, visit <a href="http://www.schmersal.net">www.schmersal.net</a></li> </ul>	 <ul style="list-style-type: none"> <li>■ Function STOP 0</li> <li>■ 1- or 2-channel control</li> <li>■ Start button / autostart</li> <li>■ 2 safety outputs 2 A</li> <li>■ 1 signalling output</li> <li>■ For more information, visit <a href="http://www.schmersal.net">www.schmersal.net</a></li> </ul>

■ **Hauptsitz – Headquarters**  
**K.A. Schmersal GmbH & Co. KG**  
 Postfach 24 02 63,  
 42232 Wuppertal  
 Möddinghofe 30  
 42279 Wuppertal  
 Phone: +49 202 6474-0  
 Fax: +49 202 6474-100  
 info@schmersal.com  
 www.schmersal.com

## Germany

■ **Leipzig**  
**K.A. Schmersal GmbH & Co. KG**  
**Vertriebsbüro Leipzig**  
 Servicepark  
 Druckereistraße 4  
 04159 Leipzig  
 Phone: +49 341 48734-50  
 Fax: +49 341 48734-51  
 vbleipzig@schmersal.com

■ **Berlin**  
**KSA Komponenten der Steuerungs-  
 und Automatisierungstechnik GmbH**  
 Pankstraße 8-10 / Aufg. L  
 13127 Berlin  
 Phone: +49 30 474824-00  
 Fax: +49 30 474824-05  
 info@ksa-gmbh.de  
 www.ksa-gmbh.de

■ **Hamburg / Münster**  
**K.A. Schmersal GmbH & Co. KG**  
**Vertriebsbüro Hamburg**  
 Innungsstraße 3  
 21244 Buchholz i.d.N.  
 Phone: +49 41 81 9220-0  
 Fax: +49 41 81 9220-20  
 vbhamburg@schmersal.com

■ **Hannover**  
**ELTOP GmbH**  
 Robert-Bosch-Straße 8  
 30989 Gehrden  
 Phone: +49 51 089273-20  
 Fax: +49 51 089273-21  
 eltop@eltop.de  
 www.eltop.de

■ **Wettenberg**  
**K.A. Schmersal GmbH & Co. KG**  
**Vertriebsbüro Wettenberg**  
 Im Ostpark 2  
 35435 Wettenberg  
 Phone: +49 641 9848-575  
 Fax: +49 641 9848-577  
 vbwettenberg@schmersal.com

■ **Köln**  
**Stollenwerk**  
**Technisches Büro GmbH**  
 Scheuermühlenstraße 40  
 51147 Köln  
 Phone: +49 2203 96620-0  
 Fax: +49 2203 96620-30  
 info@stollenwerk.de  
 www.stollenwerk.de

■ **Siegen**  
**Siegfried Klein**  
**Elektro-Industrie-Vertretungen**  
 In der Steinwiese 46  
 57074 Siegen  
 Phone: +49 271 6778  
 Fax: +49 271 6770  
 info@sk-elektrotechnik.de  
 www.sk-elektrotechnik.de

■ **Saarland**  
**Herbert Neundörfer Werks-  
 vertretungen GmbH & Co. KG**  
 Am Campus 5  
 66287 Göttelborn  
 Phone: +49 6825 9545-0  
 Fax: +49 6825 9545-99  
 info@herbert-neundoerfer.de  
 www.herbert-neundoerfer.de

■ **Bietigheim**  
**K.A. Schmersal GmbH & Co. KG**  
**Technologiezentrum**  
 Pleidelsheimer Straße 15  
 74321 Bietigheim-Bissingen  
 Phone: +49 7142 91028-0  
 Fax: +49 7142 91028-28  
 tzbw@schmersal.com

■ **Bayern Süd**  
**INGAM Ing. Adolf Müller GmbH**  
**Industrievertretungen**  
 Elly-Staegmeyr-Straße 15  
 80999 München  
 Phone: +49 89 8126044  
 Fax: +49 89 8126925  
 info@ingam.de  
 www.ingam.de

■ **Nürnberg**  
**K.A. Schmersal GmbH & Co. KG**  
**Vertriebsbüro Nürnberg**  
 Lechstraße 21  
 90451 Nürnberg  
 Phone: +49 911 6496053  
 Fax: +49 911 63290729  
 vbnuernberg@schmersal.com

## Europe

■ **Austria – Österreich**  
**AVS-Schmersal Vertriebs Ges.m.b.H.**  
 Biróstraße 17  
 1232 Wien  
 Phone: +43-1-6 10 28  
 Fax: +43-1-6 10 28-1 30  
 info@avs-schmersal.at  
 www.avs-schmersal.at

■ **Belgium – Belgien**  
**Schmersal Belgium NV/SA**  
 Nieuwlandlaan 73  
 Industriezone B413  
 3200 Aarschot  
 Phone: +32-16-57 16 18  
 Fax: +32-16-57 16 20  
 info@schmersal.be  
 www.schmersal.be

■ **Bosnia and Herzegovina**  
**Tipteh d.o.o. Sarajevo**  
 Ulica Ramiza Salčina 246  
 71000 Sarajevo  
 Phone: +387-61 92 36 23  
 nadir.durmic@tipteh.ba  
 www.tipteh.ba

■ **Bulgaria – Bulgarien**  
**CDL Sensorik Ltd.**  
 Chavdar Voivoda Str, No.12, Office 1  
 7002 Ruse City  
 Phone: +359 82 82 00 52  
 office@cdlsensorik.com  
 www.cdlsensorik.com

■ **Croatia – Kroatien**  
**Tipteh Zagreb d.o.o.**  
 Ratarska 35  
 10000 Zagreb  
 Phone: +385 1-3 81 65 74  
 Fax: +385 1-3 81 65 77  
 tipteh@tipteh.hr  
 www.tipteh.hr

■ **Czech Republic – Tschech. Republik**  
**MERCOM COMPONENTA s.r.o.**  
 Bechyňská 640  
 199 00 Praha 9 – Letňany  
 Phone: +4 20-267 31 46 40-2  
 mercom@mercom.cz  
 www.mercom.cz  
 www.schmersal.cz

■ **Denmark – Dänemark**  
**Schmersal Danmark A/S**  
 Lautruphøj 1-3  
 2750 Ballerup  
 Phone: +45-70 20 90 27  
 Fax: +45-70 20 90 37  
 info@schmersal.dk  
 www.schmersal.dk

■ **Finland – Finnland**  
**Advancetec Oy**  
 Äyritie 12 B  
 01510 Vantaa  
 Phone: +3 58-2 07 19 94 30  
 Fax: +3 58-9 35 05 26 60  
 advancetec@advancetec.fi  
 www.schmersal.fi

■ **France – Frankreich**  
**Schmersal France**  
 BP 18 – 38181 Seyssins Cedex  
 8, rue Raoul Follereau  
 38180 Seyssins  
 Phone: +33-4 76 84 23 20  
 technique@schmersal.com  
 info-fr@schmersal.com  
 www.schmersal.fr

■ **Greece – Griechenland**  
**Kalamarakis Sapounas S.A.**  
**Ionias & Neromilou**  
 PO Box 46566 Athens  
 13671 Chamomilos Acharnes  
 Athens  
 Phone: +30-210-2 40 60 00-6  
 Fax: +30-210-2 40 60 07  
 ksa@ksa.gr  
 www.ksa.gr

■ **Hungary – Ungarn**  
**NTK Ipari-Elektronikai és**  
**Kereskedelmi Kft**  
 Gesztenyefa u. 4.  
 9027 Győr  
 Phone: +36-96-52 32 68  
 Fax: +36-96-43 00 11  
 info@ntk-kft.hu  
 www.ntk-kft.hu

■ **Iceland – Island**  
**Reykjafell Ltd.**  
 Skipholt 35  
 125 Reykjavik  
 Phone: +354-5 88 60 10  
 Fax: +354-5 88 60 88  
 reykjafell@reykjafell.is

■ **Italy – Italien**  
**Schmersal Italia s.r.l.**  
 Via Molino Vecchio, 206  
 25010 Borgosatollo, Brescia  
 Phone: +39-0 30-2 50 74 11  
 Fax: +39-0 30-2 50 74 31  
 info@schmersal.it  
 www.schmersal.it

■ **Lithuania/Estonia/Latvia -  
 Litauen/Estland/Lettland**  
**BOPLALIT**  
 Mus galite rasti:  
 Baltų pr. 145, LT-47125, Kaunas  
 Phone: +370 37 298989  
 Phone: +370 37 406718  
 info@boplalit.lt  
 www.boplalit.lt

■ **Macedonia – Mazedonien**  
**Tipteh d.o.o. Skopje**  
 Bul Partizanski odredi br:80, Lok:5  
 1000 Skopje  
 Phone: +389-70-39 94 74  
 Fax: +389-23-17 41 97  
 info@tipteh.mk  
 www.tipteh.mk

■ **Netherlands – Niederlande**  
**Schmersal Nederland B.V.**  
 Lorentzstraat 31  
 3846 AV Harderwijk  
 Phone: +31-3 41-43 25 25  
 Fax: +31-3 41-42 52 57  
 info-nl@schmersal.com  
 www.schmersal.nl

■ **Norway – Norwegen**  
**Schmersal Norge**  
 Hoffsvæien 92  
 0377 Oslo  
 Phone: +47-22 06 00 70  
 Fax: +47-22 06 00 80  
 info-no@schmersal.com  
 www.schmersal.no

■ **Poland – Polen**  
**Schmersal - Polska Sp.j.**  
 ul. Baletowa 29  
 02-867 Warszawa  
 Phone: +48-22-8 16 85 78  
 Fax: +48-22-8 16 85 80  
 info@schmersal.pl  
 www.schmersal.pl

■ **Portugal – Portugal**  
**Schmersal Ibérica, S.L.**  
 Apartado 30  
 2626-909 Póvoa de Sta. Iria  
 Phone: +351-30 880 09 33  
 info-pt@schmersal.com  
 www.schmersal.pt

■ **Romania – Rumänien**  
**CD SENSORIC SRL**  
 Str. George Enescu 21  
 550248 Sibiu  
 Phone: +40-2 69-25 33 33  
 Fax: +40-2 69-25 33 44  
 proiecte@cdl.ro  
 www.cdl.ro

■ **Russia – Russland**  
**OOO AT electro Moskau**  
 ul. Avtosavodskaya 16-2  
 109280 Moskau  
 Phone: +7-49 5-9 21 44 25  
 Fax: +7-49 5-9 26 46 45  
 info@at-e.ru  
 www.at-e.ru

**OOO AT electro Petersburg**  
 Polytechniskaya str, d.9,B  
 194021 St. Petersburg  
 Phone: +7-81 2-7 03 08 17  
 Fax: +7-81 2-7 03 08 34  
 spb@at-e.ru

**AT-Electronics Ekaterinburg**  
 Bebelya str. 17, room 405  
 620034 Ekaterinburg  
 Phone: +7-34 3-2 45 22 24  
 Fax: +7-34 3-2 45 98 22  
 ural@at-e.ru

■ **Serbia – Serbien**  
**Tipteh d.o.o. Beograd**  
 Moše Pijade 17A  
 11070 Vrčin, Belgrade  
 Phone: +3 81 (0)11 – 8053 628  
 Fax: +3 81 (0)11 – 8053 045  
 office@tipteh.rs  
 www.tipteh.rs

■ **Slovakia – Slowakei**  
**MERCOM COMPONENTA s.r.o.**  
 Bechyňská 640  
 199 00 Praha 9 – Letňany  
 Phone: +4 20-267 31 46 40-2  
 mercom@mercom.cz  
 www.mercom.cz  
 www.schmersal.cz

■ **Slovenia – Slowenien**  
**Tipteh d.o.o.**  
 Ulica Ivana Roba 21  
 1000 Ljubljana  
 Phone: +386-1-2 00 51 50  
 Fax: +386-1-2 00 51 51  
 info@tipteh.si  
 www.tipteh.si

■ **Spain – Spanien**  
**Schmersal Ibérica, S.L.**  
 Rambla P. Catalanes, 12  
 08800 Vilanova i la Geltrú  
 Phone: +34-902 56 64 57  
 info-es@schmersal.com  
 www.schmersal.es

■ **Sweden – Schweden**  
**Schmersal Nordiska AB**  
 F O Petersons gata 28  
 421 31 Västra Frölunda  
 Phone: +46-31-3 38 35 00  
 Fax: +46-31-3 38 35 39  
 info-se@schmersal.com  
 www.schmersal.se

- **Switzerland – Schweiz**  
**Schmersal Schweiz AG**  
 Moosmattstraße 3  
 8905 Arni  
 Phone: +41-43-3 11 22 33  
 Fax: +41-43-3 11 22 44  
 info-ch@schmersal.com  
 www.schmersal.ch
- **Turkey – Türkei**  
**Entek Otomasyon Urunleri San. ve Tic. A.S.**  
 Mahmutbey Mah.  
 Tasocagi Yolu Cad. No: 9 Entek Plaza  
 34218 Bagcilar / Istanbul  
 Phone: +90 850 201 4141  
 Fax: +90 212 320 1188  
 info@entek.com.tr  
 www.entek.com.tr
- **Ukraine – Ukraine**  
**VBR Ltd.**  
 41, Demiyivska Str.  
 03040 Kyiv Ukraine  
 Phone: +38 (044) 259 09 55  
 Fax: +38 (044) 259 09 55  
 office@vbr.com.ua  
 www.vbr-electric.com.ua/schmersal
- **United Kingdom – Großbritannien**  
**Schmersal Ltd.**  
 Sparrowhawk Close  
 Enigma Business Park  
 Malvern Worcestershire WR14 1GL  
 Phone: +44-16 84-57 19 80  
 Fax: +44-16 84-56 02 73  
 support@schmersal.co.uk  
 www.schmersal.co.uk
- **Canada – Kanada**  
**Schmersal Canada LTD.**  
 15 Regan Road Unit #3  
 Brampton, Ontario L7A 1E3  
 Phone: +1 905 495-7540  
 Fax: +1 905 495-7543  
 Info-ca@schmersal.com  
 www.schmersal.ca
- **Chile – Chile**  
**Vitel S.A.**  
 francisco@vitel.cl  
 www.vitel.cl  
**SOLTEX**  
 central@soltext.cl  
 www.soltext.com.cl  
**INSTRUTEC**  
 gcaceres@instrutec.cl  
 www.instrutec.cl  
**OEG**  
 jmp@oegggroup.com  
 www.oegggroup.cl  
**ECOL INDUSTRIAL ELECTRIC**  
 ventas@eocol.cl  
 www.eocol.cl
- **PR China – VR China**  
**Schmersal Industrial Switchgear (Shanghai) Co. Ltd.**  
 Cao Ying Road 3336  
 201712 Shanghai / Qingpu  
 Phone: +86-21-63 75 82 87  
 Fax: +86-21-63 75 82 97  
 sales@schmersal.com.cn  
 www.schmersal.com.cn
- **Colombia – Kolumbien**  
**EQUIPELCO**  
 aospina@equipelco.com  
 www.equipelco.com  
**SAMCO**  
 jvargas@samcoingenieria.com  
 www.samcoingenieria.com
- **Ecuador – Ecuador**  
**SENORTEC S.A**  
 AV. Napo y Pinto Guzmán  
 Quito  
 Phone: +593 091 40 27 65  
 +593 095 04 86 11  
 infogy@sensortecsa.com  
 www.sensortecsa.com
- **Guatemala – Guatemala**  
**PRESTELECTRO**  
 AV Petapa 44-22,  
 Zona 12; Cent. Com Florencia 01012  
 Phone: +502 24 42-33 46  
 Anabella.Barrios@prestelectro.com  
 www.prestelectro.com
- **India – Indien**  
**Schmersal India Private Limited**  
 Plot No G 7/1,  
 Ranjangaon MIDC,  
 Taluka Shirur,  
 District Pune 412220, India  
 Phone: +91 21 38 61 47 00  
 Fax: +91 20 66 86 11 14  
 info-in@schmersal.com  
 www.schmersal.in
- **Indonesia – Indonesien**  
**PT. Wiguna Sarana Sejahtera**  
 Jl. Daan Mogot Raya No. 47  
 Jakarta Barat 11470  
 Phone: +62-21-5 63 77 70-2  
 Fax: +62-21-5 66 69 79  
 email@ptwiguna.com  
 www.ptwiguna.com
- **Iran – Iran**  
**Omid Electric**  
 No. 1-5, 1st Floor, Azizi passage,  
 Southern Lalehzar Str. Tehran  
 ZIP: 1144944181  
 Phone: +98 21 33924027  
 +98 21 33911022  
 Fax: +98 21 33936635  
 sales@omidelectric.com  
 www.omidelectric.com
- **Israel – Israel**  
**A.U. Shay Ltd.**  
 23 Imber St. Kiriat. Arieah.  
 P.O. Box 10049  
 Petach Tikva 49222 Israel  
 Phone: +9 72-3-9 23 36 01  
 Fax: +9 72-3-9 23 46 01  
 shay@uriel-shay.com  
 www.uriel-shay.com
- **Japan – Japan**  
**Schmersal Japan KK**  
 3-39-8 Shoaen, Suginami-ku  
 Tokyo 167-0054  
 Phone: +81-3-3247-0519  
 Fax: +81-3-3247-0537  
 safety@schmersaljp.com  
 www.schmersal.jp
- **Korea – Korea**  
**Mahani Electric Co. Ltd.**  
 20, Gungmal-ro, Gwacheon-si,  
 Gyeonggi-do 427-060, Korea  
 Phone: +82-2-21 94-33 00  
 Fax: +82-2-21 94-33 97  
 yskim@mec.co.kr  
 www.mec.co.kr
- **Malaysia – Malaysien**  
**Ingermark (M) SDN.BHD**  
 No. 29, Jalan KPK 1/8  
 Kawasan Perindustrian Kundang  
 48020 Rawang, Selangor Darul Ehsan  
 Phone: +6 03-60-34 27 88  
 Fax: +6 03-60-34 21 88  
 enquiry@ingermark.com
- **Mexico – Mexiko**  
**ISEL SA de CV**  
 mario.c@isel.mx  
 www.isel.com.mx  
**INNOVATIVE AUTOMOTION SOLUTIONS**  
 ias@iasmx.com  
 www.iasautomation.com.mx  
**EASA ENERGIA Y AUTOMATIZACIÓN**  
 ias@iasmx.com  
 www.iasautomation.com.mx  
**DINAMICA S.A de C.V**  
 ias@iasmx.com  
 www.iasautomation.com.mx  
**SIGRAMA S.A de C.V**  
 ias@iasmx.com  
 www.iasautomation.com.mx  
**VGR TECHNOLOGIES**  
 ias@iasmx.com  
 www.iasautomation.com.mx
- **New Zealand – Neuseeland**  
**Hamer Automation**  
 85A Falsgrave Street  
 Philipstown  
 Christchurch, New Zealand  
 Phone: +64-33 66 24 83  
 Fax: +64-33 79 13 79  
 sales@hamer.co.nz  
 www.hamer.co.nz
- **Pakistan – Pakistan**  
**Multitech fze**  
 Office No.3404  
 HDS Tower, Sheikh Zayed Road,  
 P.O. Box 643650,  
 Jumeirah Lakes Tower (JLT)  
 Dubai, UAE  
 Phone: +9 71-4-4 21 46 00  
 Fax: +9 71-4-4 21 46 01  
 sales@eurotech.ae  
 www.eurotech.ae
- **Paraguay – Paraguay**  
**Brasguay S.R.L.**  
 R. Internacional 07  
 KM 14 ; Minga Guazu  
 Phone: +595 (61) 583-418 218 577  
 brasguay@brasguay.com.py  
 www.brasguay.com.py
- **Peru – Peru**  
**Fametal S.A.**  
 fametal@fametal.com  
 www.fametal.com  
**AYD**  
 informes@ayd.com.pe  
 www.ayd.com.pe
- **Singapore – Singapur**  
**AZAREL International Pte Ltd.**  
 Empire Techno Centre  
 30 Kaki Bukit Road 3 #01-10  
 Singapore 417819  
 Phone: +65-67 42 29 88  
 Fax: +65-67 42 26 28  
 sales@azarel.com.sg  
 www.azarel.com.sg
- **South Africa – Südafrika**  
**A+A Dynamic Distributors (Pty) Ltd.**  
 20-24 Augusta Road  
 Regents Park  
 2197 Booyens  
 Phone: +27-11-6 81 59 00  
 Fax: +27-11-4 35 13 18  
 awkayser@iafrica.com
- **Taiwan – Taiwan**  
**Golden Leader Camel Ent. Co., Ltd.**  
 No. 453-7, Pei Tun Rd.  
 Taichung City 40648, Taiwan  
 Phone: +886-4-22 41 29 89  
 Fax: +886-4-22 41 29 23  
 camel88@ms46.hinet.net  
 www.leadercamel.com.tw
- **Thailand – Thailand**  
**Isensor Co. Ltd.**  
 57/65 Soi Song Sa-ard  
 Vibhavadirangsit Road  
 Chomphon, Chatuchak  
 Bangkok 10900  
 Phone: +66 - 2 - 276 8783  
 Fax: +66 - 2 - 275 5875  
 info@isensor.co.th  
 www.isensor.co.th
- **United Arab Emirates – Vereinigte Arabische Emirate**  
**Multitech fze**  
 Office No. 3404, 34<sup>th</sup> Floor,  
 HDS Tower, Sheikh Zayed Road,  
 Jumeirah Lakes Towers (JLT),  
 P.O. Box 643650, Dubai, UAE  
 Phone: +9 71-4-4 21 46 00  
 Fax: +9 71-4-4 21 46 01  
 sales@eurotech.ae  
 www.eurotech.ae
- **Uruguay – Uruguay**  
**Gliston S.A.**  
 Pedernal 1896 – Of. 203  
 Montevideo  
 Phone: +598 (2) 2 00 07 91  
 colmedo@gliston.com.uy  
 www.gliston.com.uy
- **USA – USA**  
**Schmersal Inc.**  
 15 Skyline Drive  
 Hawthorne, NY 10532  
 Phone: +1 8 88-4 96-51 43  
 Fax: +1 9 14-3 47-15 67  
 infousa@schmersal.com  
 www.schmersalusa.com
- **Venezuela – Venezuela**  
**EMI Equipos y Sistemas C.A.**  
 Calle 10, Edf. Centro Industrial  
 Martinisni, Piso 3, La Urbina, Caracas  
 Phone: +58 (212) 2 43 50 72  
 ventas@emi-ve.com  
 www.emi-ve.com
- **Vietnam – Vietnam**  
**Ingermark (M) Sdn Bhd, Rep Office**  
 Unit 208, C6 Bldg., Block 1  
 My Dinh 1, New Urban Area  
 Tu Liem District, Hanoi  
 Phone: +84-4 287 2638  
 Fax: +84-4 287 2639  
 ingvietn18@ymail.com



# The Schmersal Group

In the demanding field of machine safety, the owner-managed Schmersal Group is one of the international market leaders. The company, which was founded in 1945, has a workforce of about 2000 people and seven manufacturing sites on three continents along with its own companies and sales partners in more than 60 nations.

Customers of the Schmersal Group include global players from the area of mechanical engineering and plant manufacturing as well as operators of machinery. They profit from the company's extensive expertise as a provider of systems and solutions for machine safety. Furthermore, Schmersal specialises in various areas including foodstuff production, the packaging industry, machine tool industry, lift switchgear, heavy industry and the automotive industry.

A major contribution to the systems and solutions offered by the Schmersal Group is made by tec.nicum with its comprehensive range of services: certified Functional Safety Engineers advise machinery manufacturers and machinery operators in all aspects relating to machinery and occupational safety – and do so with product and manufacturer neutrality. Furthermore, they plan and realise complex solutions for safety around the world in close collaboration with the clients.

## Safety Products



- Safety switches and sensors, solenoid interlocks
- Safety controllers and safety relay modules, safety bus systems
- Optoelectronic and tactile safety devices
- Automation technology: position switches, proximity switches

## Safety Systems



- Complete solutions for safeguarding hazard areas
- Individual parametrisation and programming of safety controllers
- Tailor-made safety technology – be it for individual machines or a complex production line
- Industry-specific safety solutions

## Safety Services



- tec.nicum academy – Seminars and training
- tec.nicum consulting – Consultancy services
- tec.nicum engineering – Design and technical planning
- tec.nicum integration – Execution and installation

The details and data referred to have been carefully checked.  
Subject to technical amendments and errors.

[www.schmersal.com](http://www.schmersal.com)



x.000 / L+W / 03.2018 / Material-Nr. 103007854 / EN / Ausgabe 03



**SCHMERSAL**  
Safe solutions for your industry