

Your Global Automation Partner

TURCK

BLxx-PG-EN-V3

Programmable CODESYS 3 gateways

User manual

1	About this manual	5
1.1	Documentation concept	5
1.1.1	Additional documentation	5
1.2	Explanation of symbols used	5
1.2.1	Warnings	5
1.2.2	Further notes	6
1.3	General notes	7
1.3.1	Prescribed use	7
1.3.2	Notes concerning planning/installation of this product	7
2	General function description	9
2.1	Function description	9
3	Hardware description	11
3.1	Device structure	11
3.2	Device dimensions	11
3.3	Block diagrams	12
3.4	Technical data	13
3.4.1	BL20-PG-EN-V3	13
3.4.2	BL67-PG-EN-V3	15
3.5	Connectors	17
3.5.1	Fieldbus connection	17
3.5.2	Power supply	18
3.5.3	USB Device port	18
3.5.4	USB Host port	19
3.6	Device addressing and operation mode setting	19
3.6.1	Restore IP	20
3.6.2	Address setting via rotary coding switches (Static rotary)	20
3.6.3	Address setting via the mode DHCP	21
3.6.4	Address setting via the mode PGM	21
3.6.5	Address setting via the mode PGM-DHCP (universal mode)	22
3.6.6	F_Reset (Reset to factory setting)	23
3.6.7	Address setting with Turck IP Address Tool	24
3.6.8	Address setting via DTM	26
3.7	SET button	28
3.8	Reset to factory settings	29
3.8.1	IP Address Tool	29
3.8.2	Web server	30
3.9	LED displays	31

3.9.1	LED description BL20	31
3.9.2	LED description BL67	33
3.10	Real time clock (RTC)	35
3.11	SFTP access	36
3.12	Firmware update	37
3.12.1	Firmware update using USB storage device	37
3.12.2	Firmware update via DTM	37
4	Parameters and diagnostics	39
4.1	Parameters	39
4.2	Diagnostics	40
4.2.1	System diagnostics	40
4.2.2	I/O diagnostics	41
5	CODESYS-functions	43
5.1	Supported CODESYS libraries	43
5.2	General start-up	44
5.2.1	Installing the device package in CODESYS	44
5.2.2	Standard project with BLxx-PG-EN-V3 in CODESYS V3.5.8.10	45
5.3	Modbus TCP-Master	46
5.3.1	Configuring the Modbus TCP-Master	46
5.3.2	Configuring the external Modbus TCP slave	47
5.4	Modbus TCP-Slave-Device	49
5.4.1	Configuring Modbus TCP-Slave-Device	49
5.5	PROFINET-Device	51
5.5.1	Configuring the PROFINET-device in CODESYS	51
5.5.2	Configuring the PROFINET-device in the PROFINET-master	53
5.6	EtherNet/IP Slave (Device)	56
5.6.1	Configuring the EtherNet/IP-device in CODESYS	56
5.6.2	Configuring the EtherNet/IP-slave in EtherNet/IP PLC	58
6	USB Host port functions	61
6.1	Compatible storage devices	61
6.2	Functions of the USB Host port	61
6.2.1	General hints/prerequisites	62
6.2.2	Function overview	63
6.2.3	Executing the functions	65
6.2.4	Behavior of the RUN-LED in case of an error	66

7	The web server	67
7.1	Web server - remote access/configuration	67
7.2	Safety in the web server	67
7.3	IP address	67
7.4	Home	68
7.5	Gateway Diagnostics	69
7.6	Ethernet Statistics	70
7.7	Links	70
7.8	Login/password	71
7.9	Change Admin Password	71
7.10	Network Configuration	73
7.10.1	Change network parameters (port settings, IP address, etc.)	73
7.11	Gateway Configuration	74
7.11.1	Configuration of the field bus interface	74
7.11.2	Reboot	74
7.11.3	Reset to Factory Defaults	74
7.12	Slot Parameters	75
7.12.1	Parameterization of the in-/ outputs	75
7.13	Using mobile devices	76
7.14	Web server logout	76
7.15	Deactivating the web server	76



1 About this manual

1.1 Documentation concept

This manual describes the hardware and the functions of the CODESYS V3-programmable gateways for the Turck product families BL20 and BL67 (BL20-PG-EN-V3 and BL67-PG-EN-V3).

The following chapters contain:

- the hardware description of BLxx-PG-EN-V3,
- the description of the device functionalities (master/device),
- the description of the Modbus-master, **page 46**
- examples for the connection of the BLxx-PG-EN-V3 as device (slave)
 - Modbus TCP Slave Device, **page 49**
 - PROFINET IO-Device, **page 51**
 - EtherNet/IP-Device, **page 56**

1.1.1 Additional documentation

Please read the following product family manuals for any general product line specific issues e.g. system description, mounting, electrical installation, station configuration etc.

BL20:

- **D300717** „BL20 I/O modules - hardware and engineering“

BL67:

- **D300529** „BL67 I/O modules - hardware and engineering“

1.2 Explanation of symbols used

1.2.1 Warnings

Action-related warnings are placed next to potentially dangerous work steps and are marked by graphic symbols. Each warning is initiated by a warning sign and a signal word that expresses the gravity of the danger. The warnings have absolutely to be observed:



DANGER!

DANGER indicates an immediately dangerous situation, with high risk, the death or severe injury, if not avoided.



WARNING!

WARNING indicates a potentially dangerous situation with medium risk, the death or severe injury, if not avoided.



CAUTION!

CAUTION indicates a potentially dangerous situation with low risk, middle or low injury, if not avoided.



ATTENTION!

ATTENTION indicates a situation that may lead to property damage, if it is not avoided.

1.2.2 Further notes



NOTE

In NOTES you find tips, recommendations and important information. The notes facilitate work, provide more information on specific actions and help to avoid overtime by not following the correct procedure.



TECHNICAL BASICS

The TECHNICAL BASICS offer technical information, basics and background information. This information lead to a better understanding of the device functions for example. The experienced user can skip this information.

➤ CALL TO ACTION

This symbol identifies steps that the user has to perform.

↪ RESULTS OF ACTION

This symbol identifies relevant results of steps

1.3 General notes

Please read this section carefully. Safety aspects cannot be left to chance when dealing with electrical equipment.

This manual includes all information necessary for the prescribed use of the devices BL20-PG-EN-V3 and BL67-PG-EN-V3. It has been specially conceived for personnel with the necessary qualifications.

1.3.1 Prescribed use

The devices described in this manual must be used only in applications prescribed in this manual or in the respective technical descriptions, and only with certified components and devices from third party manufacturers.

Appropriate transport, storage, deployment and mounting as well as careful operating and thorough maintenance guarantee the trouble-free and safe operation of these devices.

1.3.2 Notes concerning planning/installation of this product

All respective safety measures and accident protection guidelines must be considered carefully and without exception.

2 General function description

2.1 Function description

The programmable BL20/BL67 gateways can be used as autonomous PLCs or as decentral PLCs in a network interconnection for a fast preprocessing of signals. The programmable gateways allow autonomous control of applications without higher-level control.

The Ethernet ports serve as interface for programming, configuration and field bus communication.

Thanks to the multiprotocol Ethernet technology, the device can be used as slave with PLCs or PC based systems with PROFINET, EtherNet/IP or Modbus TCP. In addition to that, the device can be operated as Modbus TCP-master.

Gateways are the head component of a BL20 station. The electronic modules communicate over the internal module bus with the gateway and can be configured independently of the fieldbus protocol.

Properties:

- Programmable according to IEC 61131-3 with ODESYS V3 in:
 - IL = Instruction List
 - LD = Ladder Logic
 - FBD = Function Block Diagram
 - SFC = Sequential Function Chart
 - ST = Structured Text
- Ethernet- and programming interface
- Integrated Gold CAP-buffered RTC (Real Time Clock)
- USB Device Port as programming and service interface
- USB Host Port for connecting USB memory sticks for firmware-update, program backup, program restore, data synchronization
- Protocol converter - for example from Ethernet to serial communication.
- LEDs for display of PLC status (LED APL, LED RUN), supply voltage (LED VI/VO, BL67 only), group (LED ERR) and bus errors (LED BUS)
- Integrated Ethernet switch allows line topology
- Integrated web server
- Field bus connection
 - BL67-PG-EN-V3: Ethernet, 2 x M12-female connector, 4-pol. D-codes
 - BL20-PG-EN-V3: Ethernet, 2 x RJ45-ports,
- Power supply
 - BL67-PG-EN-V3: 5-pole 7/8"-connector
 - BL20-PG-EN-V3: screw terminals
- Protection class:
 - BL67-PG-EN-V3: IP67
 - BL20-PG-EN-V3: IP20

3 Hardware description

3.1 Device structure

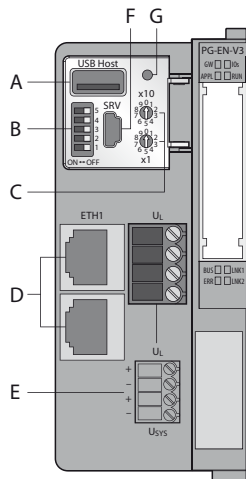

Fig. 1: Device structure BL20-PG-EN-V3

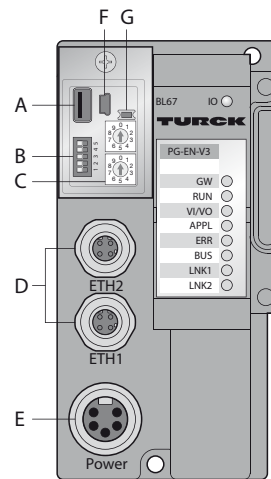

Fig. 2: Device structure BL67-PG-EN-V3

- A** USB Host port
- B** DIP-switch for setting the operation mode
- C** Rotary coding switch for address assignment
- D** Ethernet ports
- E** Power supply
- F** USB-Device port (Service)
- G** SET button

3.2 Device dimensions

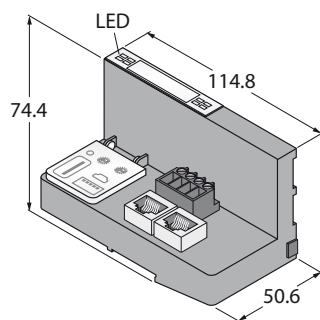

Fig. 3: Device dimensions BL20-PG-EN-V3

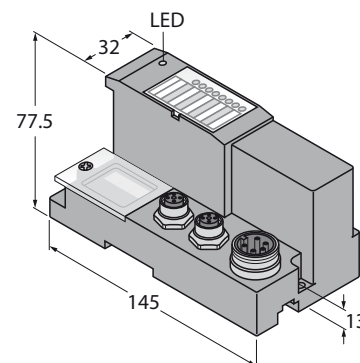

Fig. 4: Device dimensions BL67-PG-EN-V3

3.3 Block diagrams

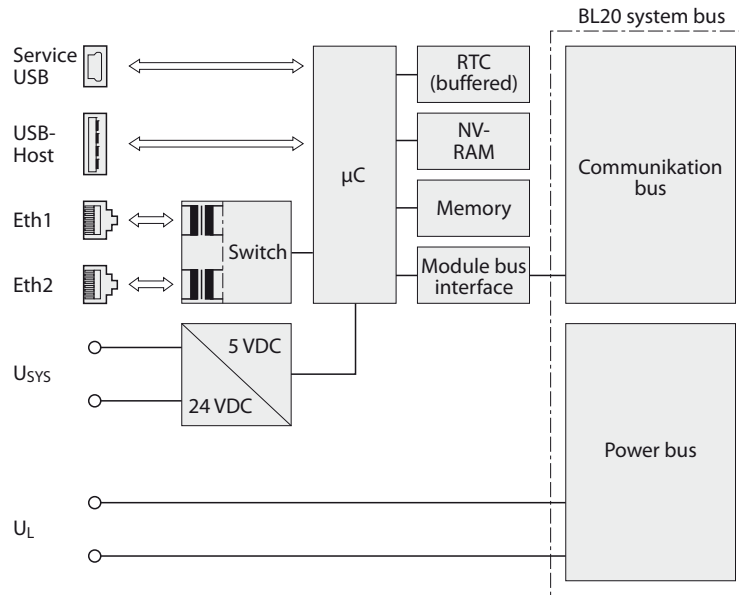

Fig. 5: Block diagram BL20-PG-EN-V3

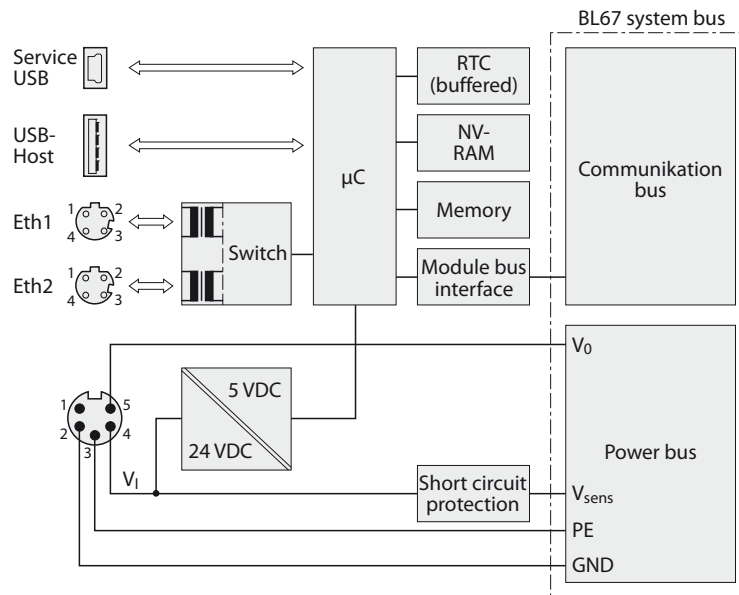

Fig. 6: Block diagram BL67-PG-EN-V3

3.4 Technical data

3.4.1 BL20-PG-EN-V3

Power supply	
Power supply	24 VDC
System supply	24 VDC/5 VDC
Field supply	24 VDC
Permissible range	18...30 VDC
Nominal voltage from module bus	≤ 200 mA
Nominal current from module bus	8 A
Max. system supply current	1.3 A
Connection technology	screw terminals
Field bus	
Transmission rate	10/100 Mbps, Full/Half Duplex, Auto Negotiation, Auto Crossing
Address assignment	Rotary coding switches, PGM, DHCP
Connection technology	RJ45-connector
PLC data	
Programming	CODESYS 3
Released for CODESYS version	from V 3.5.6.30
Programming	IEC 61131-3 (IL, LD, FBD, SFC, ST)
OPC	yes
OPC UA	no
Application tasks	5
Programming interface	Ethernet, USB
Processor	ARM, 32 Bit
Cycle time	< 1ms for 1000 IL- commands (without I/O cycle)
Real time clock (RTC)	yes
Program memory	1024 kByte
Data memory	512 kByte
Input data	4 kByte
Output data	4 kByte
Non-volatile memory	16 kByte
Web server	
Default IP address	192.168.1.254
Service interface	Mini USB

Modbus TCP	
Address assignment	Static IP, BOOTP, DHCP
Supported Function Codes	FC1, FC2, FC3, FC4, FC5, FC6, FC15, FC16, FC23
Input data size	max. 1024 registers
Input register start address	0 (0x0000 hex)
Out data size	max. 1024 registers
Output register start address	0 (0x0000 hex)
EtherNet/IP	
Address assignment	according to EtherNet/IP standard
Input data size	248 INT
Out data size	248 INT
PROFINET	
Address assignment	DCP
Conformance Class	B (RT)
MinCycleTime	1 ms
Diagnostics	according to PROFINET Alarm Handling
Topology detection	supported
Automatic address assignment	supported
Input data size	max. 512 byte
Out data size	max. 512 byte
Ambient conditions	
Operating temperature	-20...+ 60 °C
Storage temperature	-25...+70 °C
Relative humidity	15 to 95% (internal), Level RH-2, no condensation (at 45 °C storage)
Vibration test	according to EN 61131
Shock test	according to IEC 68-2-27
Drop and topple	according to EN 68-2-31 and free fall according to IEC 68-2-32
Electro-magnetic compatibility	according to IEC 61131-2
Protection class	IP20
General	
Dimensions (w × l × h)	50,6 × 114,8 × 74,4mm
Approvals	CE

3.4.2 BL67-PG-EN-V3

Power supply	
Power supply	24 VDC
System supply	24 VDC/5 VDC
Field supply	24 VDC
Permissible range	18...30 VDC
Nominal voltage from module bus	≤ 100 mA
max. sensor supply I_{sens}	4 A electronic short circuit fuse
max. load current I_o	10 A
Nominal current from module bus	10 A
Max. system supply current	1.2 A
Connection technology	5-pole 7/8"-connector
Field bus	
Transmission rate	10/100 Mbps, Full/Half Duplex, Auto Negotiation, Auto Crossing
Address assignment	Rotary coding switches, PGM, DHCP
Connection technology	2 x M12, 4-Pin, D coded
PLC data	
Programming	CODESYS 3
Released for CODESYS version	from V 3.5.6.30
Programming	IEC 61131-3 (IL, LD, FBD, SFC, ST)
OPC	yes
OPC UA	not supported
Application tasks	5
Programming interface	Ethernet, USB
Processor	ARM, 32 Bit
Cycle time	< 1ms for 1000 IL- commands (without I/O cycle)
Real time clock	yes
Program memory	1024 kByte
Data memory	512 kByte
Input data	4 kByte
Output data	4 kByte
Non-volatile memory	16 kByte
Web server	
Default IP address	192.168.1.254
Service interface	Mini USB

Modbus TCP	
Address assignment	Static IP, BOOTP, DHCP
Supported Function Codes	FC1, FC2, FC3, FC4, FC5, FC6, FC15, FC16, FC23
Input data size	max. 1024 registers
Input register start address	0 (0x0000 hex)
Out data size	max. 1024 registers
Output register start address	0 (0x0000 hex)
EtherNet/IP	
Address assignment	according to EtherNet/IP standard
Input data size	248 INT
Out data size	248 INT
PROFINET	
Address assignment	DCP
Conformance Class	B (RT)
MinCycleTime	1 ms
Diagnostics	according to PROFINET Alarm Handling
Topology detection	supported
Automatic address assignment	supported
Input data size	max. 512 byte
Out data size	max. 512 byte
Ambient conditions	
Operating temperature	-40...+70 °C
Temperature derating	
> 55 °C	Derating: max. field supply current = 5 A
Storage temperature	-40...+85 °C
Relative humidity	15 to 95% (internal), Level RH-2, no condensation (at 45 °C storage)
Vibration test	according to EN 61131
up to 5 g (at 10 to 150 Hz)	for mounting on DIN rail no drilling according to EN 60715, with end bracket
up to 20 g (at 10 to 150 Hz)	for mounting on base plate or machinery Therefore every second module has to be mounted with two screws each.
Shock test	according to IEC 68-2-27
Drop and topple	according to EN 68-2-31 and free fall according to IEC 68-2-32
Electro-magnetic compatibility	according to IEC 61131-2
Protection class	IP67
DIN rail mounting	yes, please observe offset
Direct mounting	two mounting holes, 6 mm Ø
General	
Dimensions (w × l × h)	74 × 145 × 77.5mm
Approvals	CE

3.5 Connectors

3.5.1 Fieldbus connection

BL20-PG-EN-V3

The field bus connection is realized via:
2 x RJ45-connector

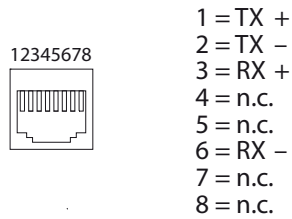

TX+	Transmission Data +
RX+	Receive Data +
TX-	Transmission Data -
RX-	Receive Data -

BL67-PG-EN-V3

The field bus connection is realized via:
2 x M12 (female connector), M12-Ethernet switch, 4-pole, D-coded, according to IAONA specification

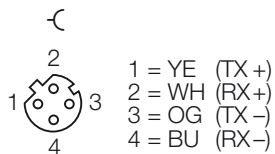

Signal	Data
TX+	Transmission Data +
RX+	Receive Data +
TX-	Transmission Data -
RX-	Receive Data -

3.5.2 Power supply BL20-PG-EN-V3

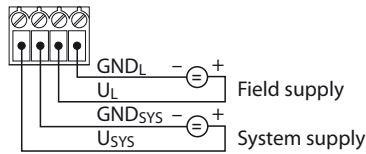

BL20-PG-EN-V3

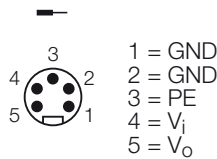

Pin- no.	Color	7/8"	Designation
1	black	GND	
2	blue	GND	
3	green/yellow	PE	Protective earth
4	Brown	$V_i (U_B)$	Feed-in of nominal voltage for input modules (sensor supply V_{sens}); also used for the generation of the system supply voltage
5	white	$V_o (U_L)$	Feed-in of nominal voltage for output modules (can be switched off separately).

3.5.3 USB Device port

The USB Device port is designed as mini USB socket and can be used as service interface for the device DTMs as well as as programming interface for CODESYS.

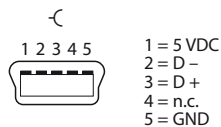

RNDIS driver

The corresponding RNDIS driver is installed during the DTM installation in PACTware. The USB device port is shown in the DTM as additional Ethernet port .



NOTE

Use the interface BL Service Ethernet in the DTM for the connection to the BLxx-PG-EN-V3.

3.5.4 USB Host port

The USB Host port is designed as USB2.0-A-socket and serves for connecting USB memory sticks for the restore and backup of CODESYS programs and for the actualization of the device firmware (see **Functions of the USB Host port (page 61)**).

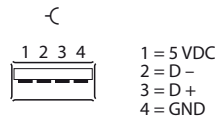

3.6 Device addressing and operation mode setting

The device address and the operation mode are set using a combination of the 2 rotary coding switches and the DIP switches at the device.

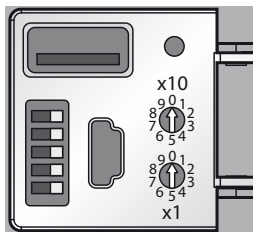

Fig. 7: Rotary coding and DIP switches at BL20-PG-EN-V3

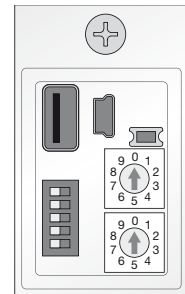

Fig. 8: Rotary coding and DIP switches at BL67-PG-EN-V3

Rotary coding switches	DIP switches A					Mode	Description
	5 (MODE)	4	3	2	1		
00	1	0	0	-	-	Restore IP	Reset the device to default settings (see page 20): IP address 192.168.1.254 Subnet mask 255.255.255.0 gateway 192.168.1.1 Auto-negotiation/ AutoMDIX active QuickConnect/FSU inactive
40	1	-	-	-	-	DHCP	Addressing via DHCP (see page 21)
50	1	-	-	-	-	PGM	Addressing via PGM (see page 21)
60	1	-	-	-	-	PGM-DHCP	Addressing via PGM-DHCP (see page 22) State of delivery
90	1	-	-	-	-	F_Reset	Reset to factory settings (see page 23)
1-99	0	-	-	-	-	Static rotary	Sets the last byte of the IP address (see page 20). The other 3 byte are taken from the IP address, which was stored in the device before.
00	0	0	0	-	-	Address	Sets the last byte of the IP address to 100. The other 3 byte are taken from the IP address, which was stored in the device before.

A „-“: Switch position is irrelevant

3.6.1 Restore IP

With this setting the DIP-switches to "000" followed by a voltage reset, the module is set to the address 192.168.1.254 for IP-based services (see **Device addressing and operation mode setting (page 19)**).

This setting allows for example the I/O-ASSISTANT 3 (FDT/DTM) to communicate with the station, the device's WEB-server can be accessed using the IP-address 192.168.1.254.



NOTE

This setting is no operation mode! Please set the device to another mode after having reset the IP address to the default values.

3.6.2 Address setting via rotary coding switches (Static rotary)

When using the rotary-mode, the last byte of the station's IP address can be set via the rotary coding switches.



NOTE

All other network settings are stored in the module's non-volatile EEPROM and can not be changed in rotary mode.

Addresses from 1 to 99 can be set. The addresses 0 is used for Broadcast-messages in the subnet.

The following example shows the setting of address **73**.

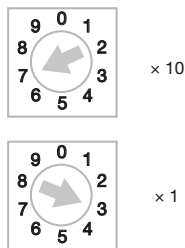

NOTE

The settings carried out in the rotary-mode are not stored in the module's EEPROM. Thus, they will get lost in case of a subsequent address-assignment via a BootP/DHCP or PGM.



NOTE

After changing the position of the rotary coding-switches, a voltage reset must be carried out to store the new address.

3.6.3 Address setting via the mode DHCP

In order to activate the DHCP-mode, the DIP-switch MODE is set to "ON", the rotary switches to address "40" (see **Device addressing and operation mode setting (page 19)**).

Address setting is carried out by a DHCP-server in the network after the start-up of the gateway.

The IP address, as well as the default subnet mask assigned to the gateway by the DHCP-server, are stored in the module's EEPROM. If the gateway is subsequently switched to another address-mode, the settings (IP address, subnet mask, etc) will be read from the module's EEPROM.



NOTE

After every change of the address-mode, a voltage reset must be done.

DHCP supports three mechanisms for IP address allocation:

- In "automatic allocation", the DHCP-server assigns a permanent IP address to a client.
- In "dynamic allocation", DHCP assigns an IP address to a client for a limited period of time. After this time, or until the client explicitly relinquishes the address, the address can be re-assigned.
- In "manual allocation", a client's IP address is assigned by the network administrator, and DHCP is used simply to convey the assigned address to the client.

DHCP in PROFINET

Please assure, that in PROFINET-applications, the address assigned via a BootP-server corresponds to the address, which is assigned in the configuration tool.

3.6.4 Address setting via the mode PGM

In order to activate the PGM-mode, the DIP-switch MODE is set to "ON", the rotary switches to address "50" (see **Device addressing and operation mode setting (page 19)**).



NOTE

After every change of the address-mode, a voltage reset must be done.

The PGM-mode enables access of the software I/O-ASSISTANT (FDT/DTM) to the module's network settings (see also „Address setting via DTM“).



NOTE

In the PGM-mode, all network settings (IP address, subnet mask, etc.) are read from the module's internal EEPROM.

3.6.5 Address setting via the mode PGM-DHCP (universal mode)

In order to activate the PGM-DHCP-mode, the DIP-switch MODE is set to "ON", the rotary switches to address "60" (see **Device addressing and operation mode setting (page 19)**).



NOTE

After every change of the address-mode, a voltage reset must be done.

The device sends DHCP-requests until an IP address is assigned (DHCP-server, PROFINET-controller, PACTware, web server, IP-Address Tool).

The assigned IP-address is stored to the device and the DHCP-client is stopped.

Even after a restart of the device, the device sends no further DHCP-requests.

PGM-DHCP in PROFINET

This mode assures a PROFINET-compliant operation of the modules.



NOTE

If a DHCP-server is used within the network, problems may occur during IP-assignment. In this case, both, the DHCP-server as well as the PROFINET-controller (via DCP), try an IP-address-assignment.

3.6.6 F_Reset (Reset to factory setting)

In order to reset the device to factory settings, the DIP-switch MODE is set to "ON", the rotary switches to address "90" (see **Device addressing and operation mode setting (page 19)**).

This mode sets all device-settings back to the default values and deletes all data in the device's internal flash.



NOTE

This setting is no operation mode! Please set the device to another mode after having reset the IP address to the default values.

The following properties are reset to default or deleted during F_Reset:

		Default value	Comment
IP address/ subnet mask	Reset	192.168.1.254/ 255.255.255.0	The device can be accessed by the web server/DTM using this IP address but the address is not permanently stored in the device.
PROFINET device name	Reset	-	
CODESYS program	deleted	-	
parameters (PG-V3)	Reset	see Parameters (page 39)	
Parameters of I/O-modules	no		



NOTE

Resetting the device to factory settings via DCP-based services (via Turck IP Address Tool or TIA-Portal/Step7) does not delete the CODESYS-program (see also **Reset to factory settings (page 29)**).

3.6.7 Address setting with Turck IP Address Tool

The Turck IP Address Tool enables direct access to the Ethernet-network via the Ethernet cable.

The IP configuration, as well as the PROFINET device name of the Ethernet device can be changed application specifically.

Search for devices

Scan the network using the "Search" button. All found Turck devices are shown.

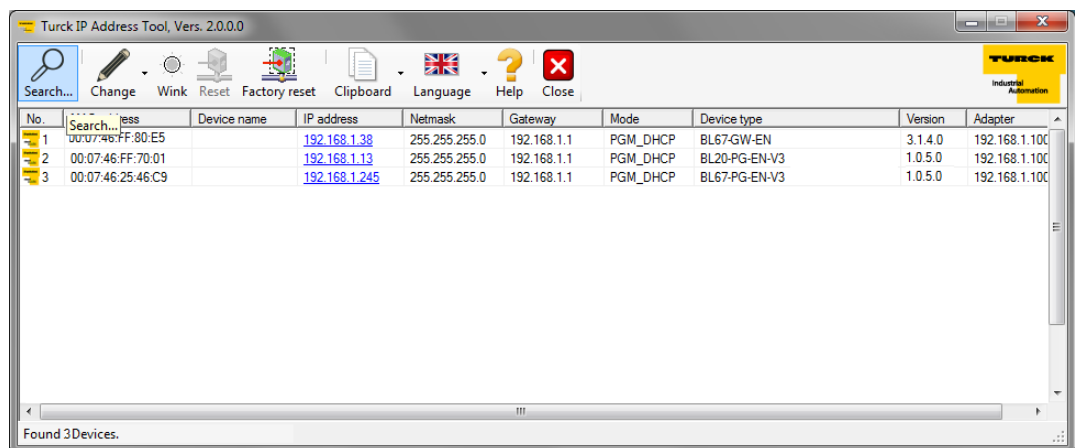

Fig. 9: Scan Ethernet network

Send WINK command

For clear device localization a Wink command can be send to the marked device using the "Wink" button. The device responds to this Wink command with a device specific blink code (see **LED displays (page 31)**).

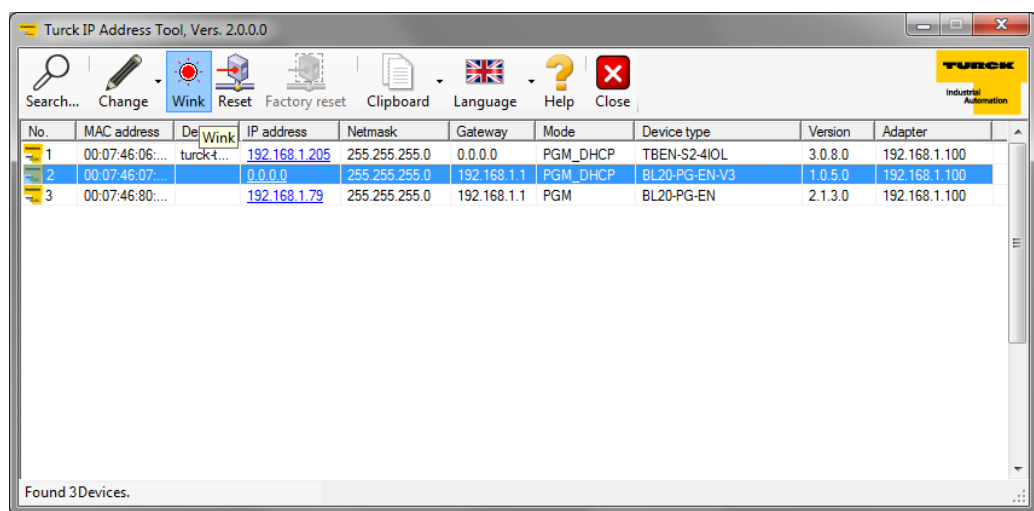

Fig. 10: Send WINK command

Changing the IP address

Use the function "Change → IP configuration" to change the device's IP settings.

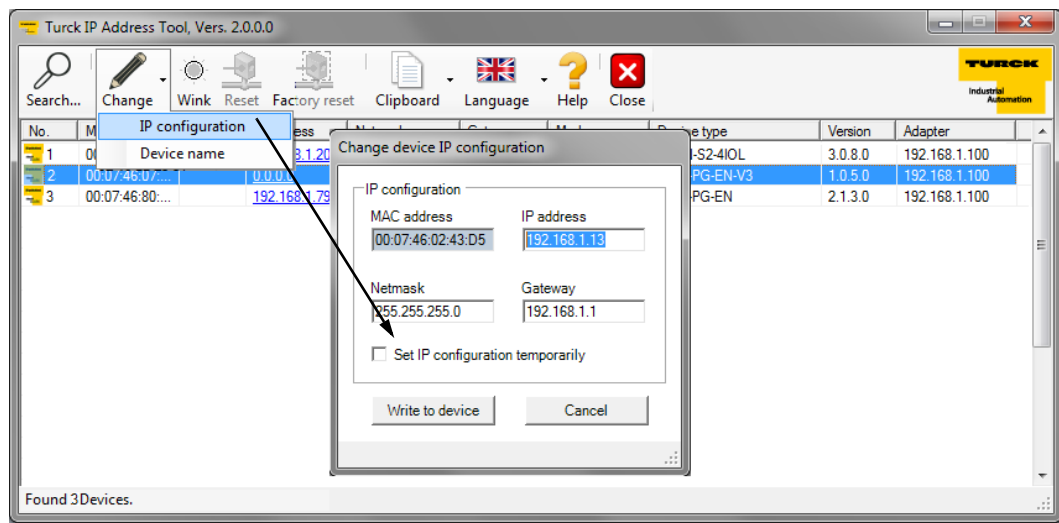

Fig. 11: Changing the IP configuration

Changing the PROFINET device name

Use the function "Change → device name" to change the device's IP settings.

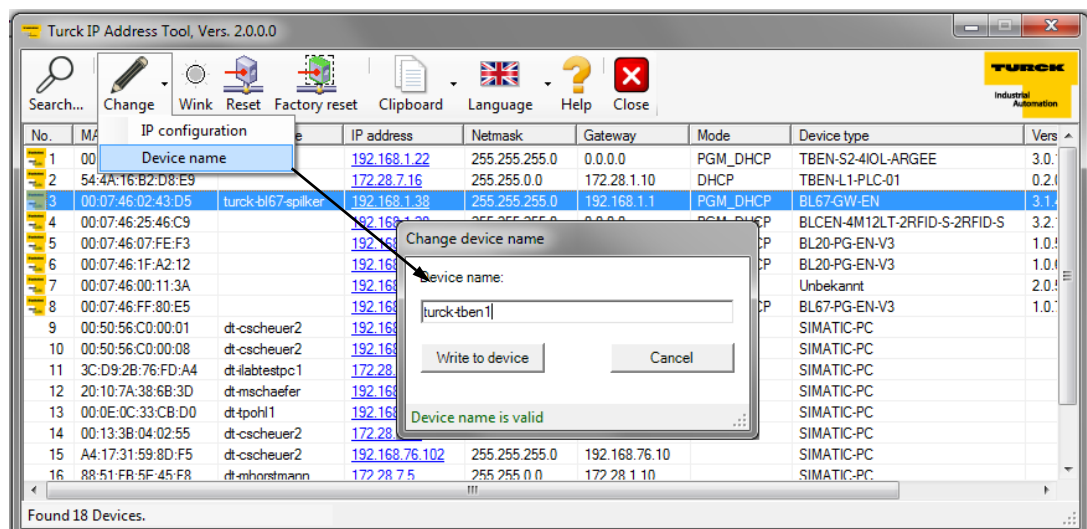

Fig. 12: Set PROFINET device name



NOTE

A PROFINET device name can only be assigned, if the device has already been configured as PROFINET device via CODESYS and if the respective CODESYS project has been loaded to the device (see [chapter 5, PROFINET-Device \(page 51\)](#)).

3.6.8 Address setting via DTM

The software-tool I/O-ASSISTANT 3 (FDT/DTM) enables direct access to the Ethernet-network via the Ethernet cable.

The IP address, as well as the subnet mask of the TURCK Ethernet stations, can be changed according to the application by using the Busaddress Management function of the BL Service Ethernet interface (TCP/IP) in the software I/O-ASSISTANT 3 (FDT/DTM).

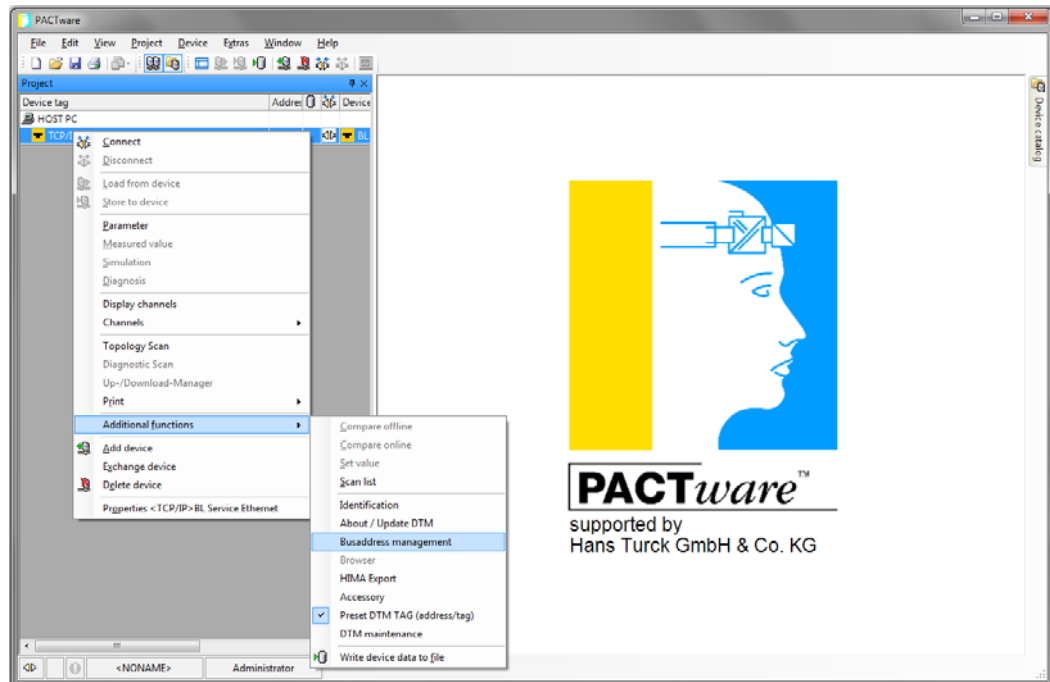

Fig. 13: Busaddress management

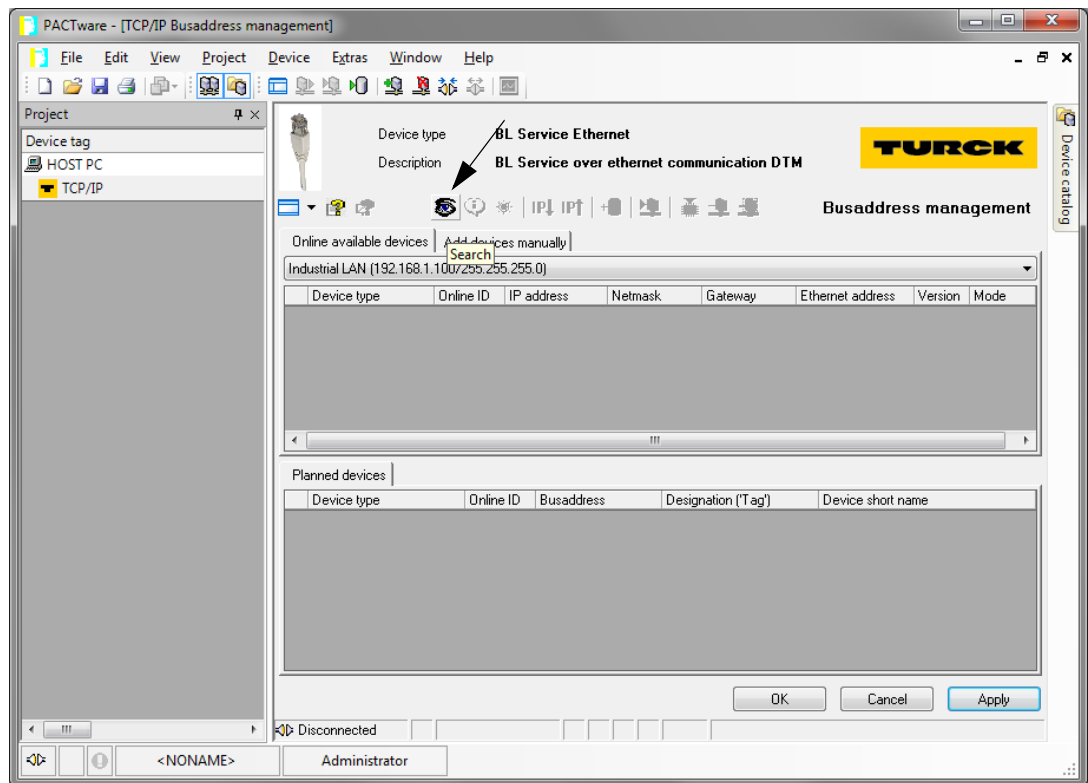

Fig. 14: Searching for network nodes in the Busaddress Management



NOTE

The access of the DTM to the station is only possible, if the station already has an IP-address (see **Device addressing and operation mode setting (page 19)**) and if it is operated in switch position PGM or PGM-DHCP-mode.



NOTE

When using Windows XP as operating system, difficulties may occur with system-integrated firewall. It may inhibit the access of PACTware (I/O-ASSISTANT V3) to the Ethernet-network. In this case, please adapt your firewall respectively or deactivate it.

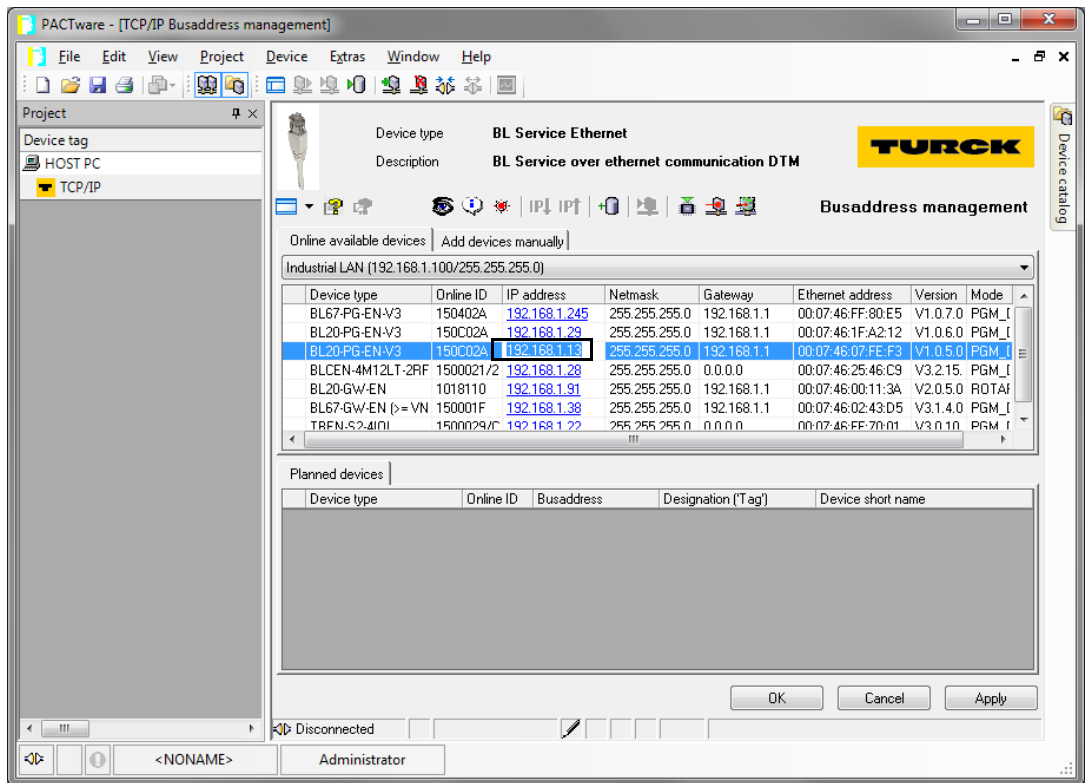

Fig. 15: Changing the IP address

3.7 SET button

Pressing the SET button activates the write access of the device's USB Host port functions, see also [chapter 6, USB Host port functions \(page 61\)](#).

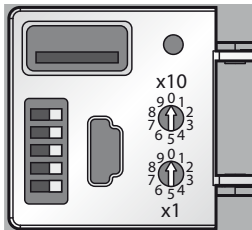

Fig. 16: SET button at BL20-PG-EN-V3

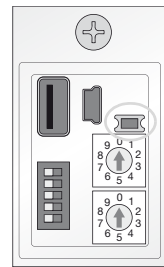

Fig. 17: SET button at BL20-PG-EN-V3

3.8 Reset to factory settings

Besides the hardware rest using the rotary coding switches (see **F_Reset (Reset to factory setting) (page 23)**), the TURCK IP Address Tool as well as the web server (see **Reset to Factory Defaults (page 74)**) offer the possibility to reset the devices to the factory settings.



NOTE

Resetting the device to factory settings **via rotary coding/DIP switches** deletes the CODE-SYS-program in the device, see also **F_Reset (Reset to factory setting) (page 23)**.
 Resetting the device to factory settings **via DCP-based services** (via Turck IP Address Tool or TIA-Portal/Step7) does not delete the CODESYS-program (see also **F_Reset (Reset to factory setting) (page 23)**).

3.8.1 IP Address Tool

No.	MAC address	Device name	IP address	Netmask	Gateway	Mode	Device type	Vers
1	00:07:46:FF:70:01		192.168.1.2	255.255.255.0	0.0.0.0	PGM_DHCP	TBEN-S2-4IOL-ARGEE	3.0.
2	54:4A:16:B2:D8:E9		172.28.7.16	255.255.0.0	172.28.1.10	DHCP	TBEN-L1-PLC-01	0.2.
3	00:07:46:02:43:D5	turck-bl67-spilker	192.168.1.38	255.255.255.0	192.168.1.1	PGM_DHCP	BL67-GW-EN	3.1.
4	00:07:46:25:46:C9		192.168.1.28	255.255.255.0	0.0.0.0	PGM_DHCP	BLCEN-4M12LT-2RFID-S-2RFID-S	3.2.
5	00:07:46:07:FE:F3		192.168.1.13	255.255.255.0	192.168.1.1	PGM_DHCP	BL20-PG-EN-V3	1.0.
6	00:07:46:1F:A2:12		192.168.1.29	255.255.255.0	192.168.1.1	PGM_DHCP	BL20-PG-EN-V3	1.0.
7	00:07:46:00:11:3A		192.168.1.91	255.255.255.0	192.168.1.1	ROTARY	Unbekannt	2.0.
8	00:07:46:FF:80:E5		192.168.1.245	255.255.255.0	192.168.1.1	PGM_DHCP	BL67-PG-EN-V3	1.0.
9	00:50:56:C0:00:01	dt-cscheuer2	192.168.203.1	255.255.255.0	0.0.0.0		SIMATIC-PC	
10	00:50:56:C0:00:08	dt-cscheuer2	192.168.113.1	255.255.255.0	0.0.0.0		SIMATIC-PC	
11	3C:D9:2B:76:FD:A4	dt-labtestpc1	172.28.7.23	255.255.0.0	172.28.1.10		SIMATIC-PC	
12	20:10:7A:38:6B:3D	dt-mschaefer	192.168.76.17	255.255.255.0	192.168.76.10		SIMATIC-PC	
13	00:0E:0C:33:CB:D0	dt-pohl1	192.168.1.71	255.255.255.0	0.0.0.0		SIMATIC-PC	
14	00:13:3B:04:02:55	dt-cscheuer2	172.28.7.29	255.255.0.0	172.28.1.10		SIMATIC-PC	
15	A4:17:31:59:8D:F5	dt-cscheuer2	192.168.76.102	255.255.255.0	192.168.76.10		SIMATIC-PC	
16	88:51:FB:5F:45:F8	dt-mhorstmann	172.28.7.5	255.255.0.0	172.28.1.10		SIMATIC-PC	

Found 18 Devices.

Fig. 18: IP Address Tool, reset to factory settings

3.8.2 Web server

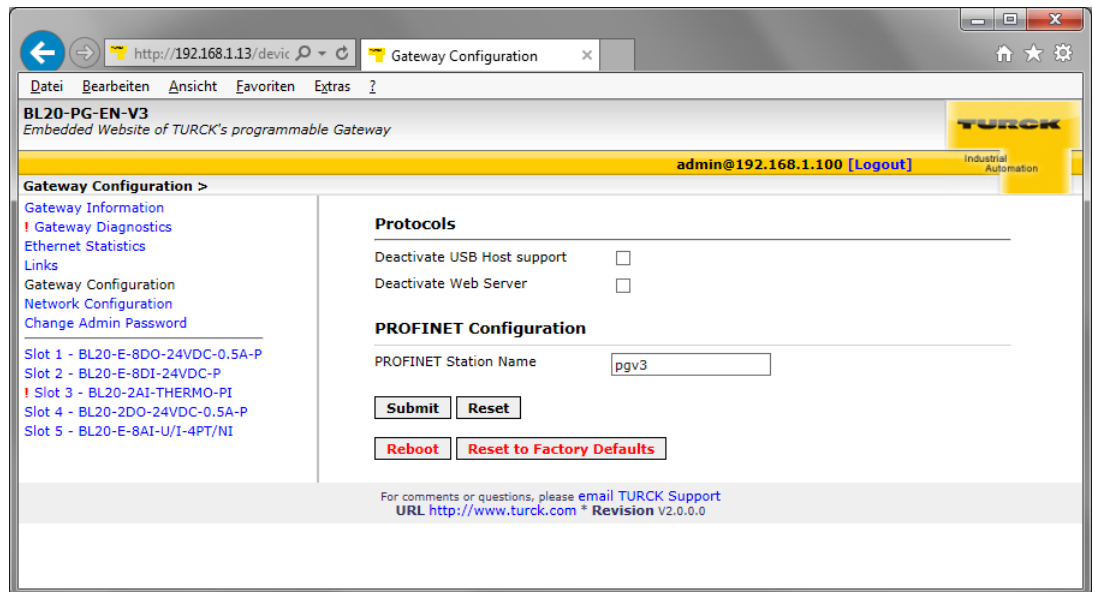

Fig. 19: Web server, reset to factory settings



NOTE

For further information concerning the web server please read **chapter 7 The web server**.

3.9 LED displays

Every BLxx-PF V3 displays the following statuses via LEDs:

- PLC status (LED RUN),
- application specific LED APPL (freely programmable via CODESYS)
- supply voltage (LED VI/VO, BL67 only),
- common errors (LED ERR) and
- Bus errors (LED BUS)
- 2 LEDs for the Ethernet-communication LNK1 and LNK2

3.9.1 LED description BL20

LED	GREEN	RED	Meaning	Remedy
GW	OFF	OFF	No power supply of the CPU.	– Check the system power supply at the gateway.
	ON	OFF	Firmware active, gateway ready	
	OFF	blinking	Wink-command received	– Wink-command received
IOs	off	OFF	No power supply of the CPU.	– Check the system power supply at the gateway.
	ON	OFF	Communication running. The modules configured correspond to the modules in the station.	
	blinking, 1 Hz	OFF	Station is in the Force Mode of the I/O-ASSISTANT.	– Deactivate the Force Mode of the I/O-ASSISTANT.
	OFF	ON	CPU not ready for operation, →possible causes: – too many modules at the gateway – short-circuit in connected module – gateway hardware error.	– Check the system power supply at the gateway and the cabling. – Unmount excessively mounted modules. – Replace the gateway, if necessary.
	OFF	blinking, 1 Hz	Non adaptable changes in the configuration of the module bus nodes.	– Compare the configured station and the current configuration. – Check the physical station for defective or incorrectly plugged electronic modules.
	OFF	blinking, 4 Hz	no communication via the module bus.	– At least one module has to be plugged and has to be able to communicate with the gateway.
	blinking, alternating		The current and configured module list do not match but the data exchange proceeds as normal.	– Check the physical station for pulled or new but not planned modules. – Check the system power supply at the gateway.
	OFF	blinking double 1 Hz	Device internal communication disturbed	
APPL	This LED is controlled by the CODESYS program and can be freely programmed by the user.			

LED	GREEN	RED	Meaning	Remedy
RUN	OFF	OFF	No power supply of the CPU.	– Check the system power supply at the gateway.
	ON	OFF	PLC program running	
	blinking	OFF	Firmware updated running	see Firmware update
	OFF	ON	PLC program stopped	
	OFF	blinking	No PLC program loaded	
	OFF	blinking, 1 Hz	F_Reset is in progress	see page 23

LED	GREEN	RED	Meaning	Remedy
BUS	OFF	OFF	No power supply of the CPU.	– Check the system power supply at the gateway.
	ON	OFF	Displays the logical connection to a master If more than one slave is configured at the PG, then the LED shows the state of the slave in CODESYS which was the first to be configured.	
	blinking	OFF	Device ready for operation	
	OFF	ON	Gateway error: – IP address conflict – gateway in RESTORE-mode – F_Reset activated	– Check the IP-addresses in the network – Check the DIP switch position.
	blinking, alternating		– Auto-negotiation and/or – Autonegotiation and / or waiting for DHCP- / BootP-address assignment.	– The gateway waits for IP-address assignment. Wait for the address assignment to be finished.

LED	GREEN	YELLOW	Meaning	Remedy
LNKx	OFF	OFF	no link	– Check the Ethernet connection.
	OFF	ON	Link established, 10 Mbps	
	off	blinking	Ethernet Traffic, 10 Mbps	
	ON	OFF	Link established, 100 Mbps	
	blinking	OFF	Ethernet Traffic, 100 Mbps	

LED	GREEN	RED	Meaning	Remedy
ERR	OFF	OFF	Station running, no diagnostics	
	OFF	ON	A diagnostic message from gateway or I/O-modules is pending.	– Check the diagnostic messages.

3.9.2 LED description BL67

LED	GREEN	RED	Meaning	Remedy
IO	OFF	OFF	No power supply of the CPU.	– Check the system power supply at the gateway.
	ON	OFF	Communication running. The modules configured correspond to the modules in the station.	
	blinking, 1 Hz	OFF	Station is in the Force Mode of the I/O-ASSISTANT.	– Deactivate the Force Mode of the I/O-ASSISTANT.
	OFF	ON	CPU not ready for operation, →possible causes: too many modules at the gateway short-circuit in connected module gateway hardware error.	– Check the system power supply at the gateway and the cabling. – Unmount excessively mounted modules. – Replace the gateway, if necessary.
	OFF	blinking, 1 Hz	Non adaptable changes in the configuration of the module bus nodes.	– Compare the configured station and the current configuration. – Check the physical BL67-station for defective or incorrectly plugged electronic modules.
	OFF	blinking, 4 Hz	no communication via the module bus.	– At least one module has to be plugged and has to be able to communicate with the gateway.
	blinking, alternating		The current and configured module list do not match but the data exchange proceeds as normal.	– Check the physical station for pulled or new but not planned modules. – Check the system power supply at the gateway.
	OFF	blinking double 1 Hz	Device internal communication disturbed	

LED	GREEN	RED	Meaning	Remedy
GW	OFF	OFF	No power supply of the CPU.	– Check the system power supply at the gateway.
	ON	OFF	Firmware active, gateway ready	
	OFF	blinking	Wink-command received	– Deactivate an active WINK-command

LED	GREEN	RED	Meaning	Remedy
RUN	OFF	OFF	No power supply of the CPU.	Check the system power supply at the gateway.
	ON	OFF	PLC program running	-
	blinking	OFF	Firmware updated running	see Firmware update
	OFF	ON	PLC program stopped	
	OFF	blinking	No PLC program loaded	
	OFF	blinking, 1 Hz	F_Reset is in progress	see page 23

LED	GREEN	RED	Meaning	Remedy
V_I/V_O	OFF	OFF	Supply voltage too low	– Check the system power supply at the gateway.
	ON	OFF	V _I and V _O within the nominal range	
	blinking, 1 Hz	OFF	Undervoltage V _I ; system running.	– Check the system power supply at the gateway.
	blinking, 4 Hz	OFF	Undervoltage V _O ; system running.	
	ON (orange)	ON	Sensor supply current (I _{SENS}) too high	

LED	GREEN	RED	Meaning
APPL	This LED is controlled by the CODESYS program and can be freely programmed by the user.		

LED	GREEN	RED	Meaning	Remedy
ERR	OFF	OFF	Station running, no diagnostics	
	OFF	ON	A diagnostic message from gateway or I/O-modules is pending.	– Check the diagnostic messages.
LED	GREEN	RED	Meaning	Remedy
BUS	OFF	OFF	No power supply of the CPU.	– Check the system power supply at the gateway.
	ON	OFF	Displays the logical connection to a master If more than one slaves are configured at the PG, then the LED shows the state of the slave in CODESYS which was the first to be configured.	
	blinking	OFF	Device ready for operation	
	OFF	ON	Gateway error: – IP address conflict – gateway in RESTORE-mode – F_Reset activated	– Check the IP-addresses in the network – Check the DIP switch position.
	blinking, alternating		– Auto-negotiation and/or – Autonegotiation and / or waiting for DHCP- / BootP-address assignment.	– The gateway waits for IP-address assignment. Wait for the address assignment to be finished.
LED	GREEN	YELLOW	Meaning	Remedy
LNKx	OFF	OFF	no link	– Check the Ethernet connection.
	OFF	ON	Link established, 10 Mbps	
	off	blinking	Ethernet traffic, 10 Mbps	
	ON	OFF	Link established, 100 Mbps	
	blinking	OFF	Ethernet traffic, 100 Mbps	

3.10 Real time clock (RTC)

Properties:

Buffering	via Gold CAP
Loading time for 95 % load	min. 10 minutes
Buffer time at	
23 °C	4 weeks
- 60 °C	168 hours
- 70 °C	36 hours

The RTC is set in the device for example using the CODESYS library „CAA Real time Clock Extern“.

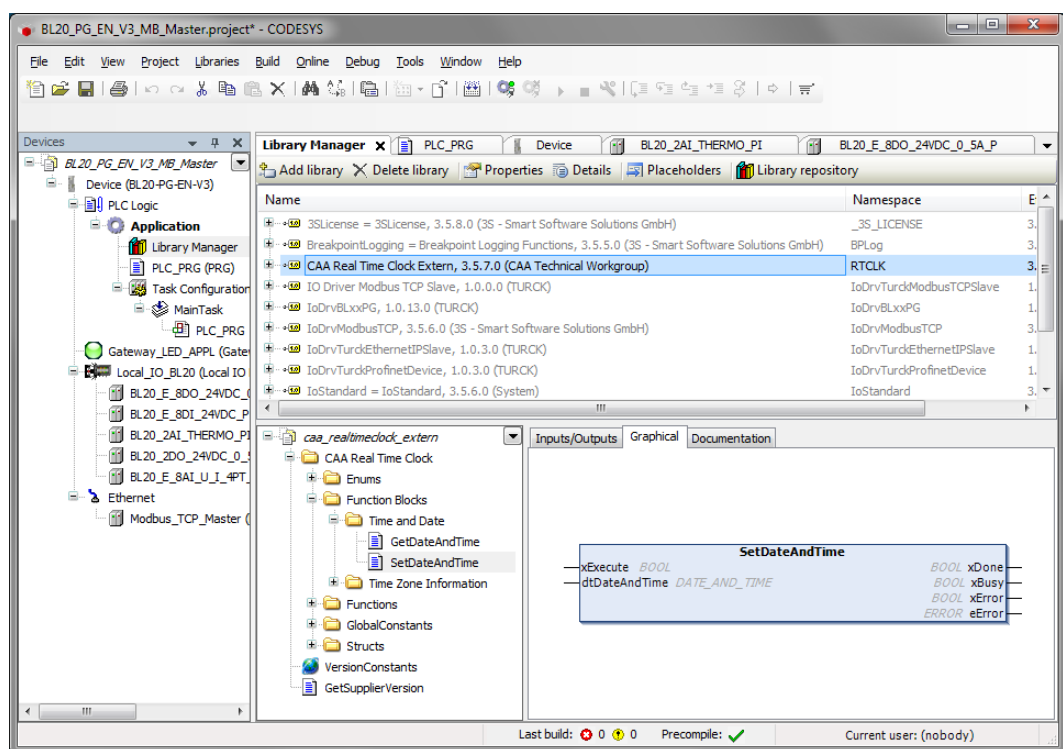

Fig. 20: CAA Real time Clock Extern in CODESYS

3.11 SFTP access

The SFTP access is done via a FTP client program e.g. FileZilla:

Server (SFTP protocol)	IP address of the device
User name	sftpuser
Password	password
Port	22



NOTE

The password for the SFTP access is synchronized to the password for the web server. Changing the password for the SFTP access also changes the web server password (see page 71).

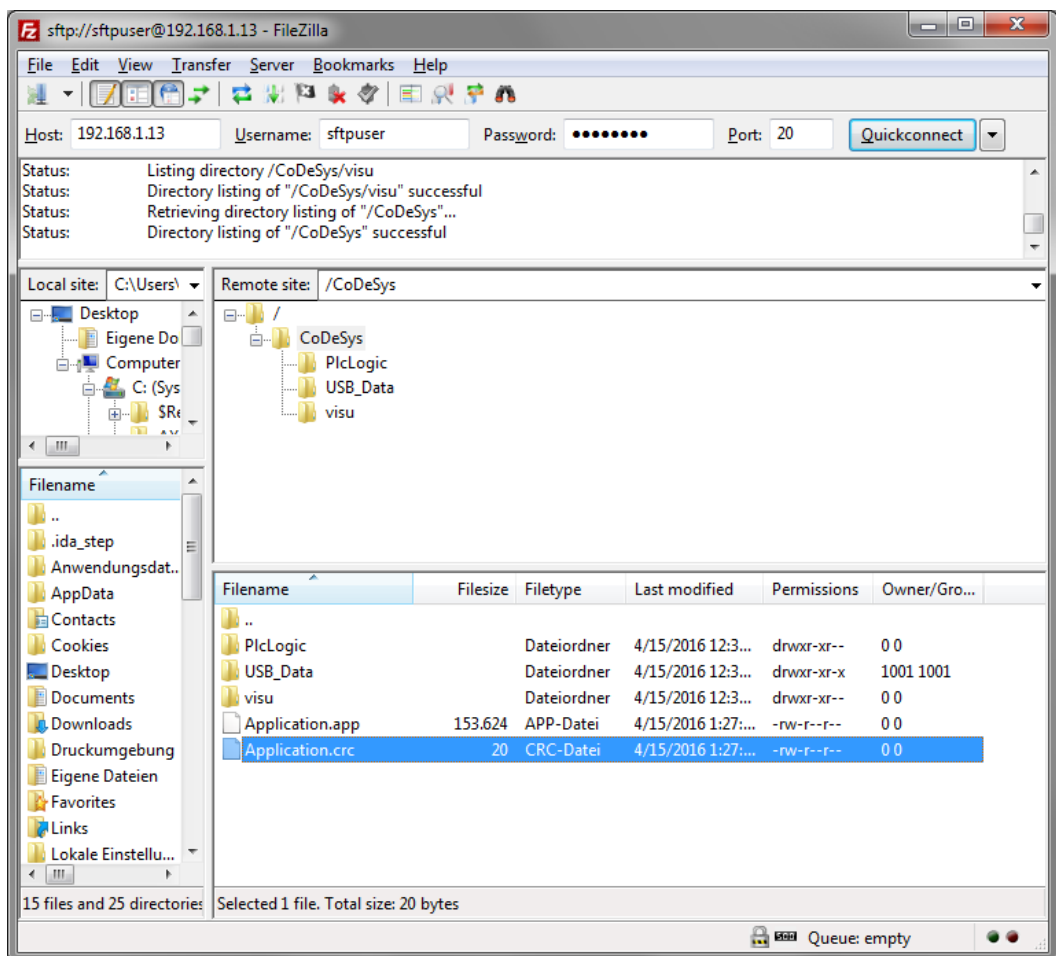

Fig. 21: SFTP access via FileZilla

3.12 Firmware update

The firmware update can be done using a USB storage device at the USB Host port or via the Turck DTM in PACTware.

3.12.1 Firmware update using USB storage device

For the firmware update via USB storage device, please read section **Functions of the USB Host port (page 61)**.

3.12.2 Firmware update via DTM

The firmware update via DTM is done in the DTM Busaddress Management in PACTware.

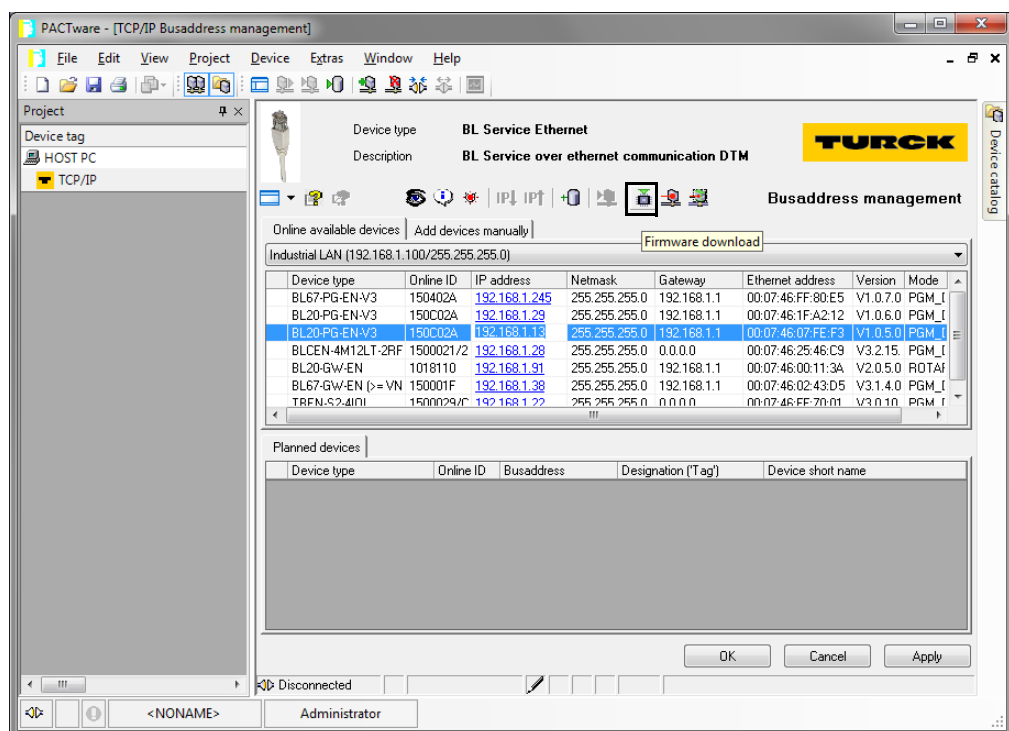

Fig. 22: Busaddress Management in PACTware

4 Parameters and diagnostics

4.1 Parameters

The BLxx-PG-EN-V3 provides the following parameters.



NOTE

Parameter changes are only applied after a device restart.

Parameter name	Value	Description
Deactivate WEB server	no A	
	yes	Deactivates the web server in the device.
Deactivate USB Host support	no A	
	yes	Deactivates the USB Host port support for the device. The USB Host port functions are deactivated.
Ethernet port 1/2	Auto-negotiation A	Sets the Ethernet port to Auto-negotiation or to a fixed value for transmission rate and transmission mode.
	10 Mbps, half duplex	
	10 Mbps, full duplex	
	100 Mbps, half duplex	
	100 Mbps, full duplex	

A Default setting

4.2 Diagnostics

4.2.1 System diagnostics

The system diagnostics can be called via the instance name of the "Local_IO_BLxx"-object. Function blocks or libraries are not required.

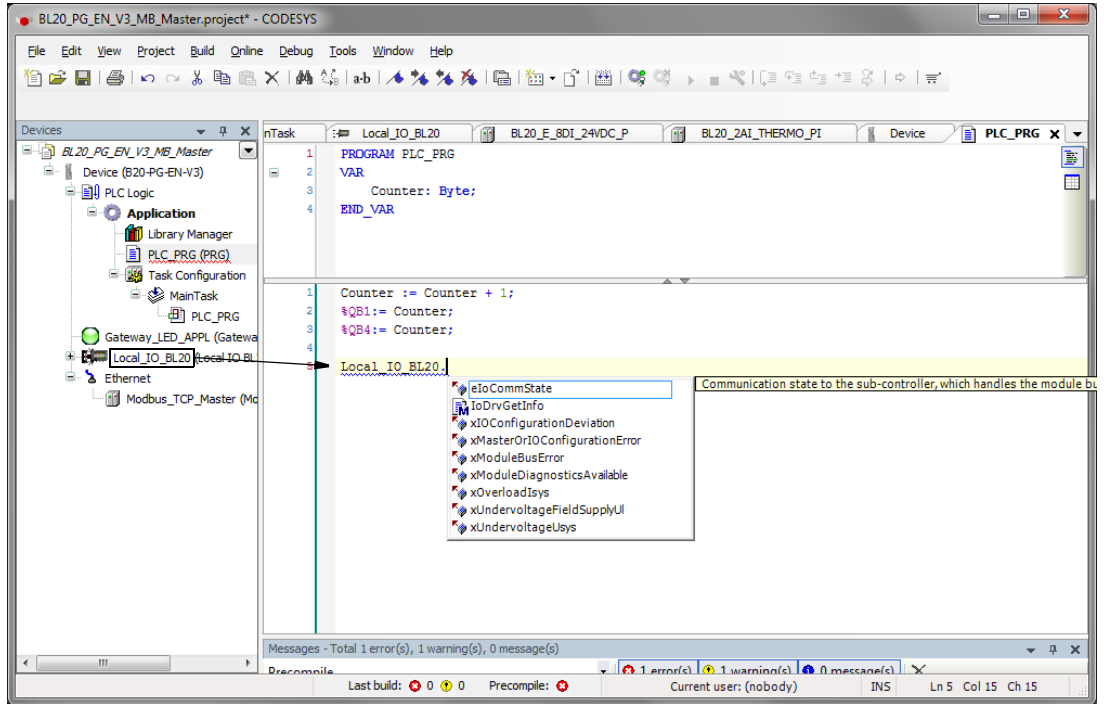

Fig. 23: Diagnostics via call of instance

Diagnostics	Meaning	
Module diagnostics available „xModuleDiagnosticsAvailable“	At least one module sends diagnostics.	Check the diagnostic messages.
I/O configuration deviation „xIOConfigurationDeviation“	I/O module list adaptable modified, e. g., module has been pulled.	The current and configured module list do not match but the data exchange proceeds as normal. – Check the physical station for pulled or new but not planned modules. – Check the system power supply at the gateway.
Module bus error „xModuleBusError“	The Communication with the module bus station on the module bus is not possible.	– At least one module has to be plugged and has to be able to communicate with the gateway.
I/O configuration error „xMasterOrIOConfigurationError“	The actual module list has been changed and is incompatible, a process data exchange with the module bus nodes is not possible.	– Compare the configured station and the current configuration. – Check the physical station for defective or incorrectly plugged electronic modules.

Diagnosics	Meaning
Undervoltage U_{sys} „xUndervoltageUsys“	The load or system voltage are out of the permissible range. Check the system power supply at the gateway.
Undervoltage at U_l „xUndervoltageFieldSupply_UI“	
Overload $_{sys}$ „xOverloadIsys“	Overload at the system supply.

4.2.2 I/O diagnostics

The diagnostics of the local I/O modules are available as process data in the modules' I/O mapping in CODESYS.

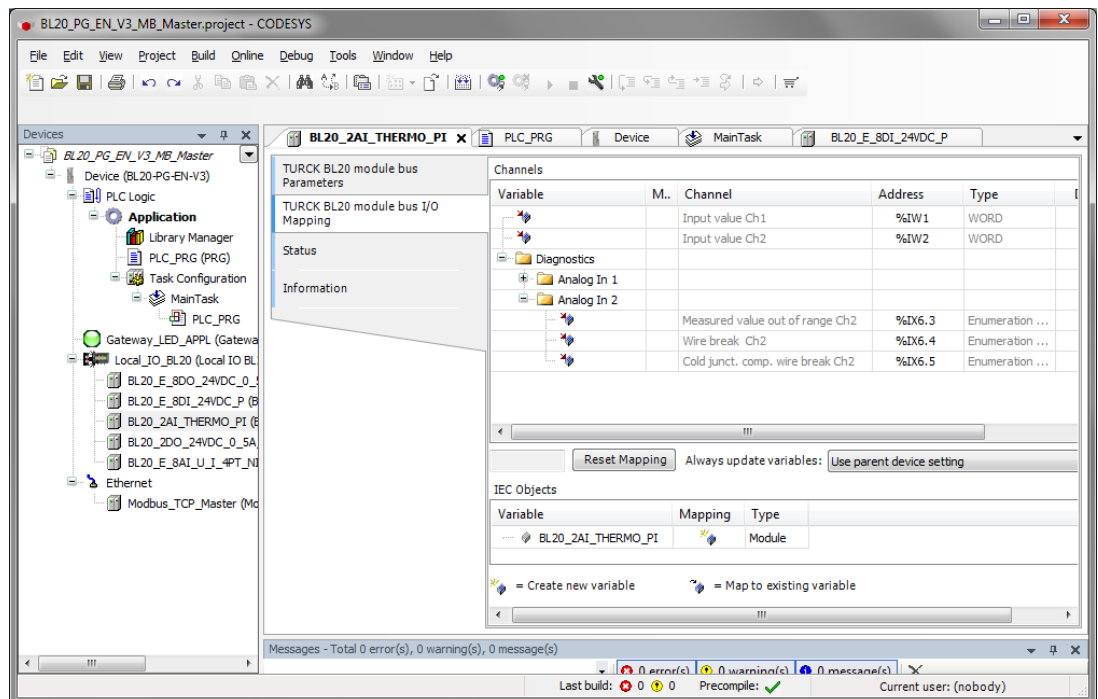

Fig. 24: I/O-module diagnostics in the process image.

5 CODESYS-functions

The CODESYS 3 programmable multiprotocol gateways BL20-PG-EN-V3 and BL67-PG-EN-V3 can be used as follows:

Protocol	Master		Slave	
Modbus TCP	✓	page 46	✓	page 49
PROFINET	-		✓	page 51
EtherNet/IP	-		✓	page 56

5.1 Supported CODESYS libraries

3S libraries	
Network	– SysSocket, 3.5.6.0 (System)
Data access	– SysFile, 3.5.6.0 (System) – SysFileAsync, 3.5.5.0 (System) – SysDir, 3.5.6.0 (System)
Time and date	– SysTime, 3.5.5.0 (System) – SysTimeCore, 3.5.5.0 (System) – SysTimer, 3.5.5.0 (System) – SysTimeRtc, 3.5.5.0 (System)
Miscellaneous	– SysEvent, 3.5.5.0 (System) – SysMem, 3.5.5.0 (System)
CAA libraries	
Network	– CAA Net Base Services, 3.5.6.0
Data access	– CAA File, 3.5.6.0
Time and date	– CAA DTUtil Extern, 3.5.5.0 – CAA Real Time Clock Extern, 3.5.5.40 – CAA Tick Extern, 3.5.5.0 – CAA TickUtil Extern, 3.5.5.0 – CAA Timer Extern, 3.5.5.0
Miscellaneous	– CAA Mathematics, 3.5.1.0 – CAA Memory, 3.5.5.0

5.2 General start-up

5.2.1 Installing the device package in CODESYS

- Download the package „BLxx-PG-EN-V3 CODESYS Package Vx.x.x.x“ from www.turck.com
- Install the package using the CODESYS Package Manager „Tools → Package Manager“.

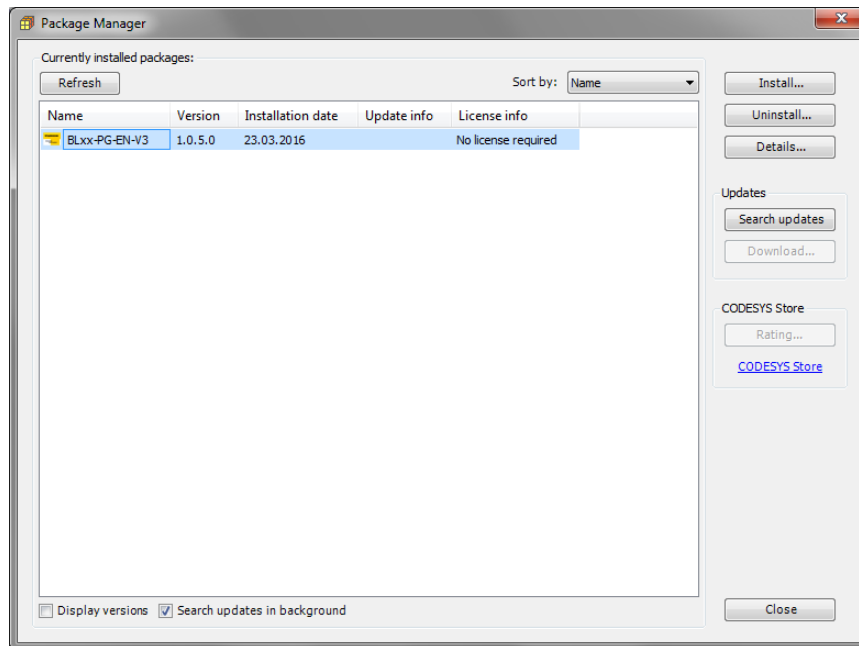

Fig. 25: Package Manager in CODESYS

The device package for CODESYS contains all necessary files

- CODESYS Device Description,
- CODESYS libraries,
- GSDML file,
- EDS file,
- etc.

5.2.2 Standard project with BLxx-PG-EN-V3 in CODESYS V3.5.8.10

- Create a standard project with the BLxx-PG-EN-V3 as CODESYS device.

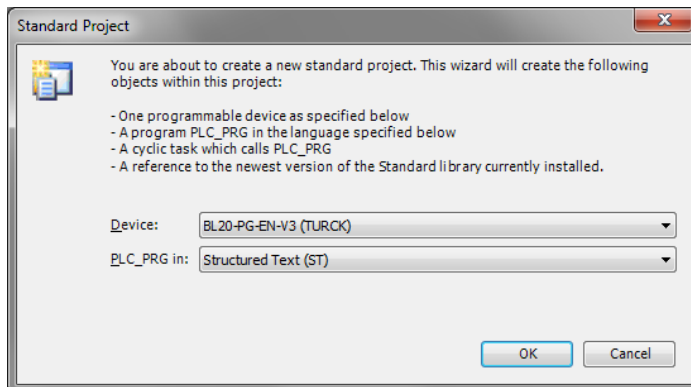

Fig. 26: Selecting the PG-V3 as CODESYS device

- ➔ The CODESYS project is created.

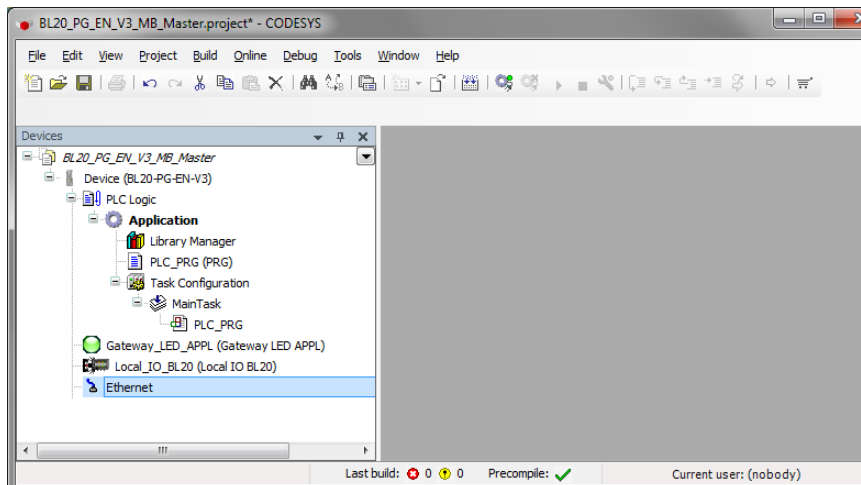

Fig. 27: CODESYS project

In addition to the PLC logic, the project contains:

- **Gateway LED APPL**
 - for free use in the program
 - uses 2 bit in the device's output process image, the output data therefore start with an offset of 1 byte in the default configuration.
- **Local_IO_BLxx**
 - Configuration of the I/O modules locally connected to the BLxx-PG-EN-V3
- **Ethernet interface**
 - Interface for the Modbus master or the Ethernet slaves



NOTE

The Ethernet interface needs no configuration.

5.3 Modbus TCP-Master

Properties	
max. number of TCP slaves	32
Min. Cycle Time	50 ms

5.3.1 Configuring the Modbus TCP-Master

The Modbus TCP master from 3S - Smart Software Solutions GmbH is used.

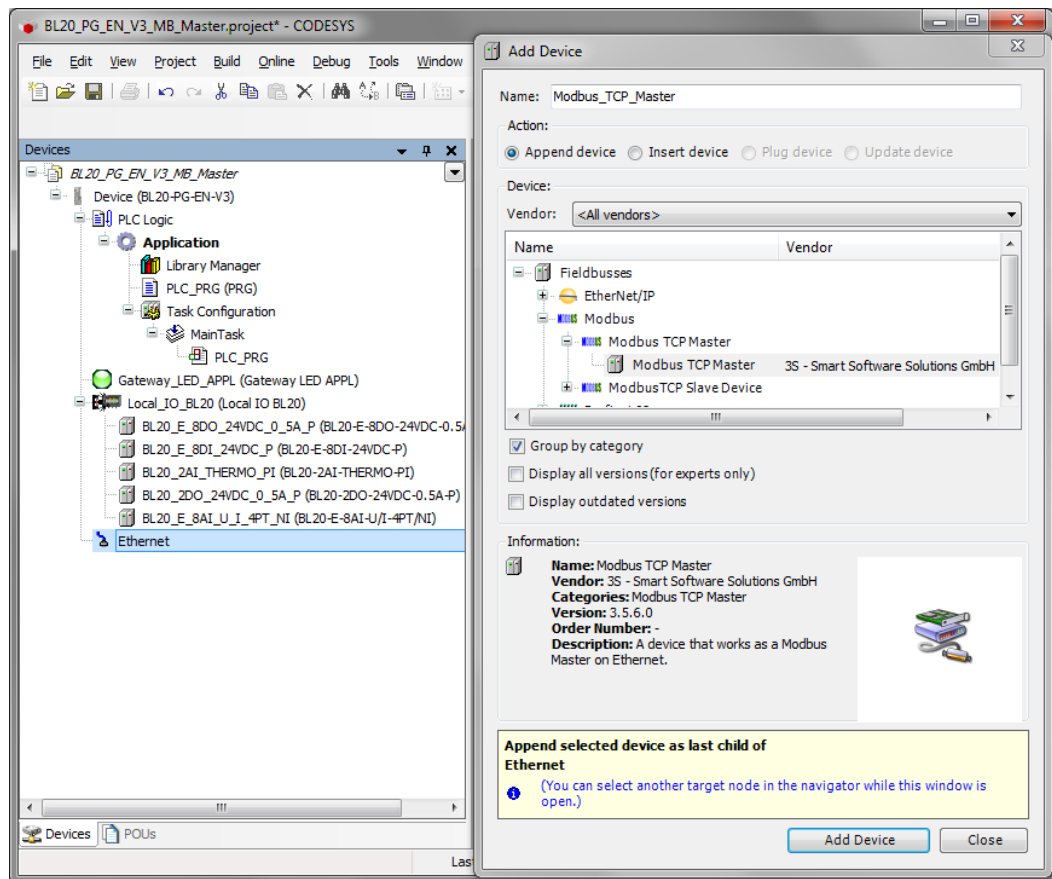

Fig. 28: Add Modbus TCP-Master

- Activate the function "auto-reconnect" at the master to assure that CODESYS automatically confirms communication errors and tries to continue with executing Modbus commands instead of interrupting the Modbus communication. Otherwise the error has to be reset using a slave function block.

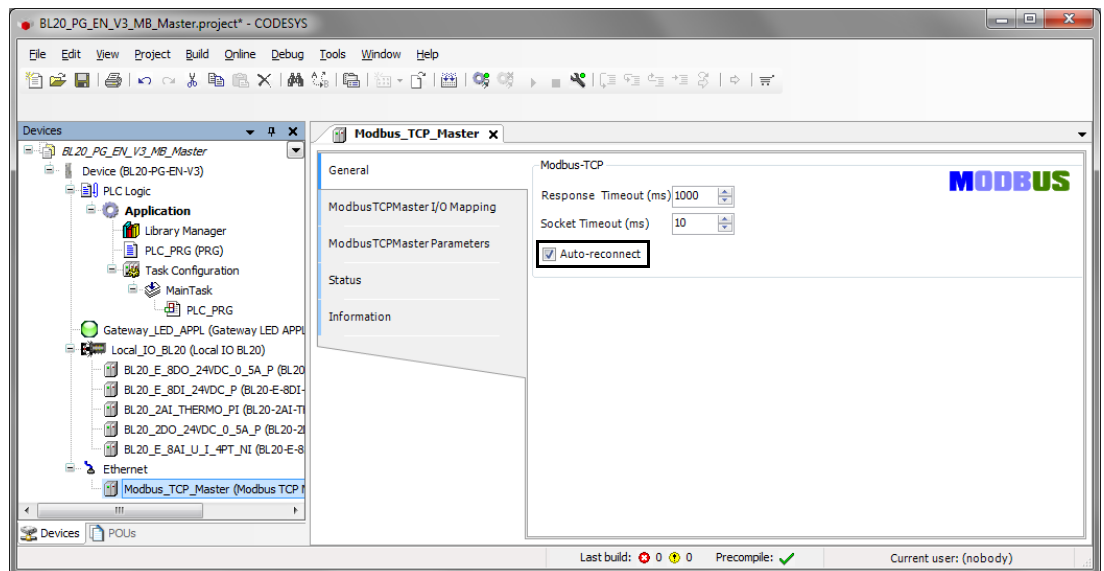

Fig. 29: Configuring the Modbus TCP-Master

5.3.2 Configuring the external Modbus TCP slave

- Add an external Modbus TCP slave using the "Add Device" function and configure the slave. In this example the Turck multiprotocol device TBEN-S1-4DIP-4DOP is used as Modbus slave.

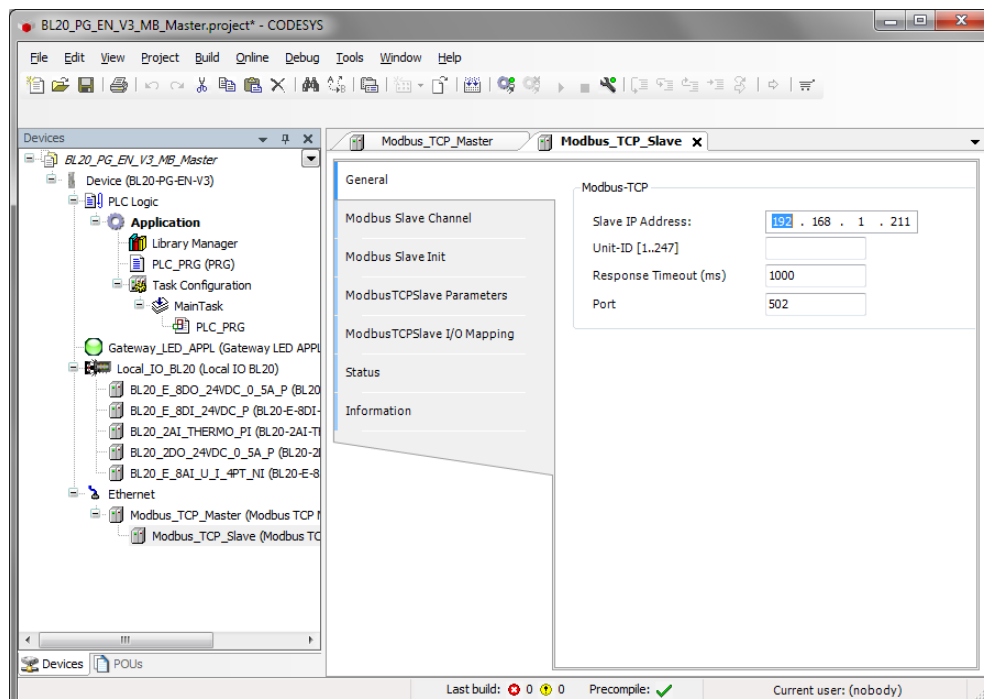

Fig. 30: Configuring the external Modbus TCP slave

- Add Modbus Slave channels for the communication with the slave.
- Observe the process data offsets of the slave. In the example (Fig. 31: Adding Modbus Slave channels) the slave's process output data start with register 0x0800.

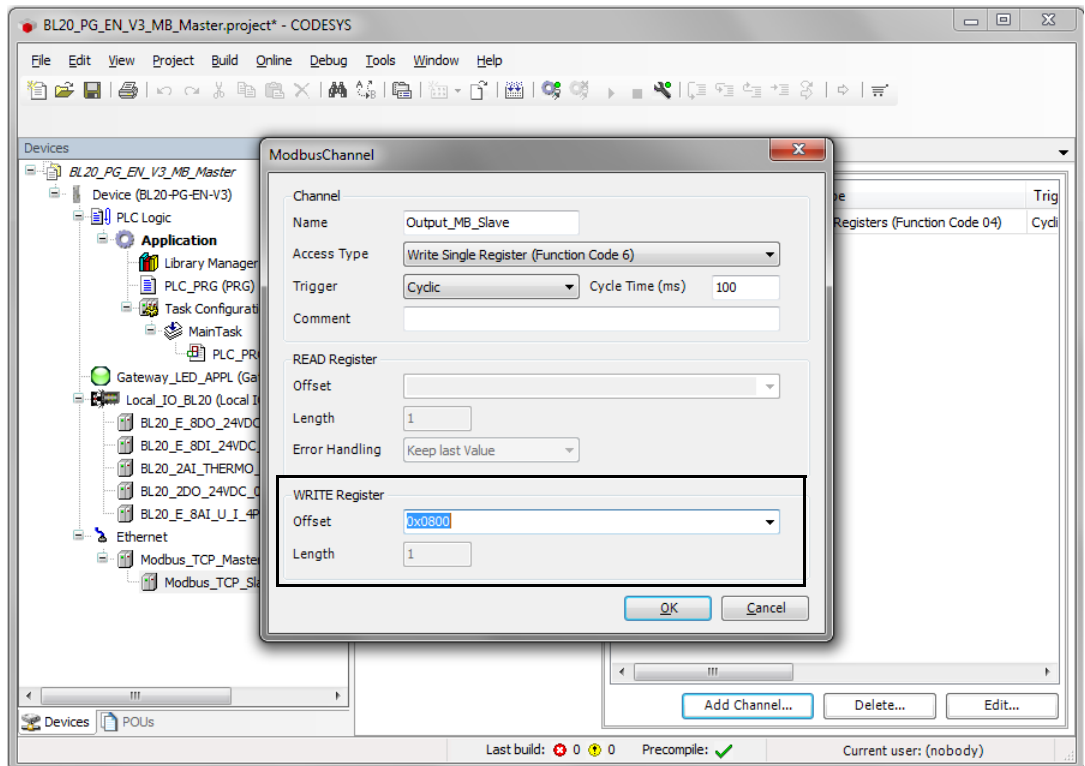

Fig. 31: Adding Modbus Slave channels

5.4 Modbus TCP-Slave-Device

Properties	
Max. number of input registers	1024
Max. number of holding registers	1024

5.4.1 Configuring Modbus TCP-Slave-Device

- Add the Modbus_TCP_Slave_Device to the Ethernet interface using the "Add Device"-function and configure it.
- Therefore define the number of in- and output registers (input and holding registers) which have to be exchanged with the higher-level Modbus TCP-master.

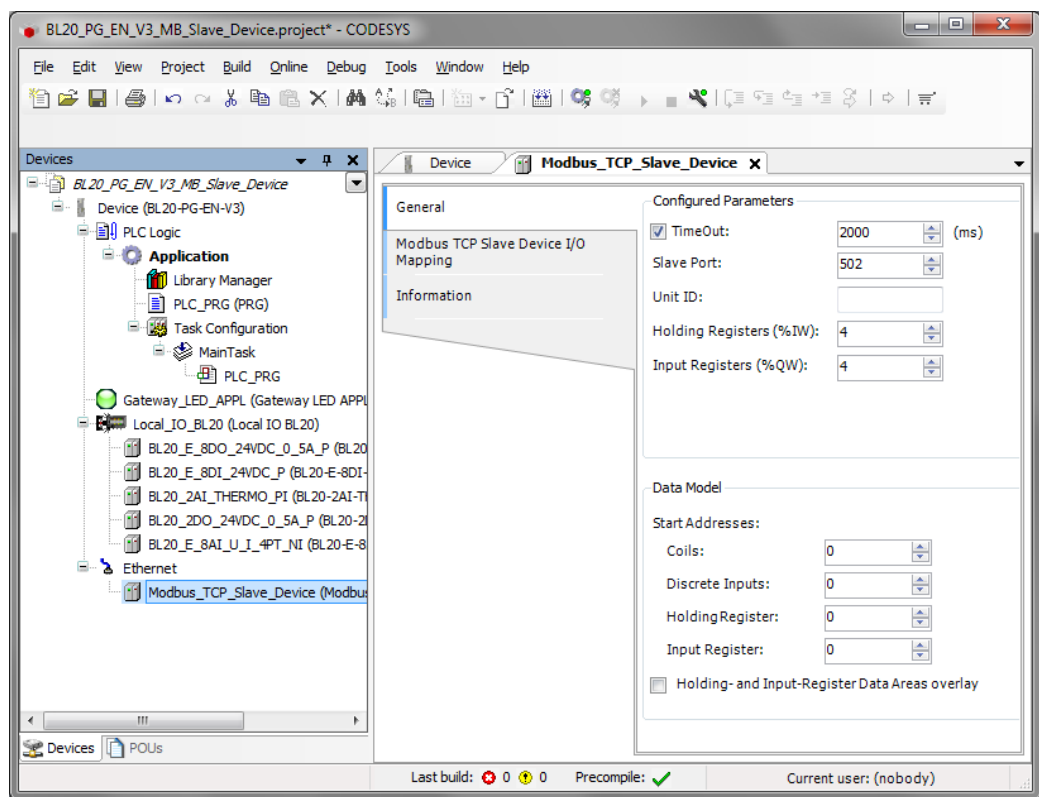

Fig. 32: Configuring Modbus TCP-Slave-Device

Which data will be mapped into the input and holding registers, depends on assignments in the PLC program or in the I/O mapping of the PG-V3 or of the local I/Os.

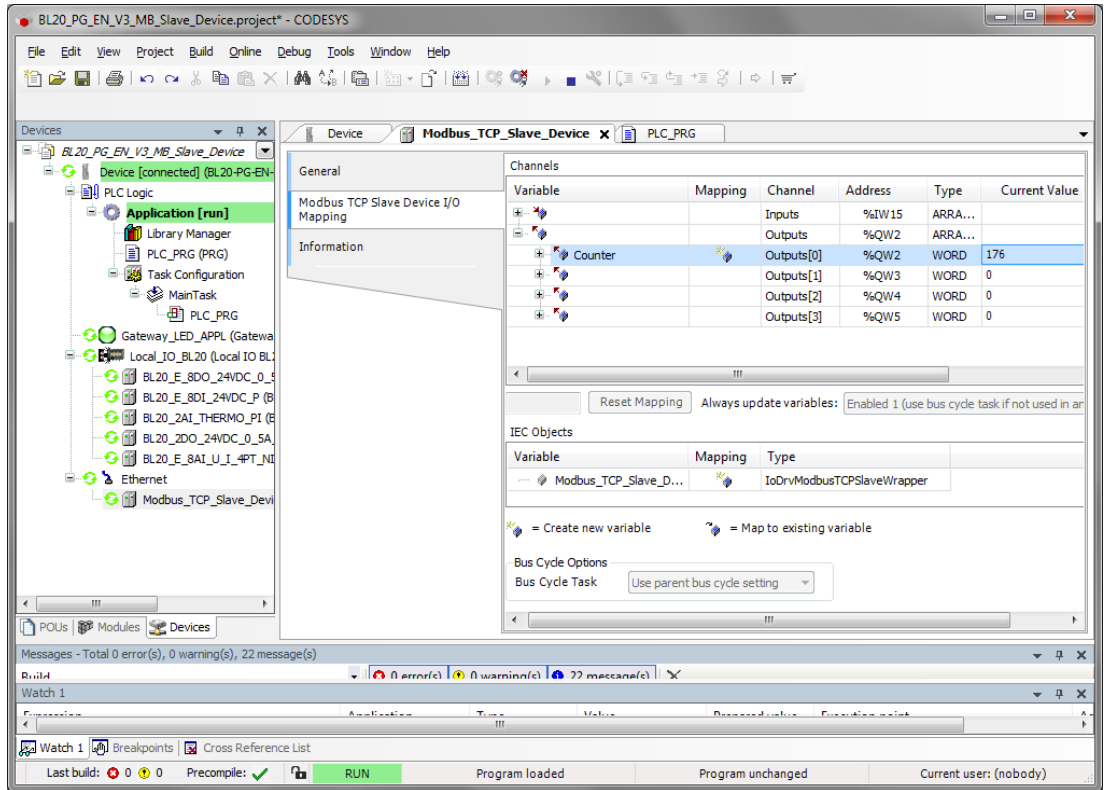

Fig. 33: Modbus TCP-Slave-Device data mapping

5.5 PROFINET-Device

Properties	
max. number of I/O data	1024 byte in total (512 IN + 512 OUT)



NOTE

It can be necessary to increase the PROFINET cycle time for larger BLxx-stations.

5.5.1 Configuring the PROFINET-device in CODESYS

- Add the PROFINET_Device to the Ethernet interface using the "Add Device"-function and configure the length of the in- and output data, which have to be exchanged with the higher-level PROFINET-master.

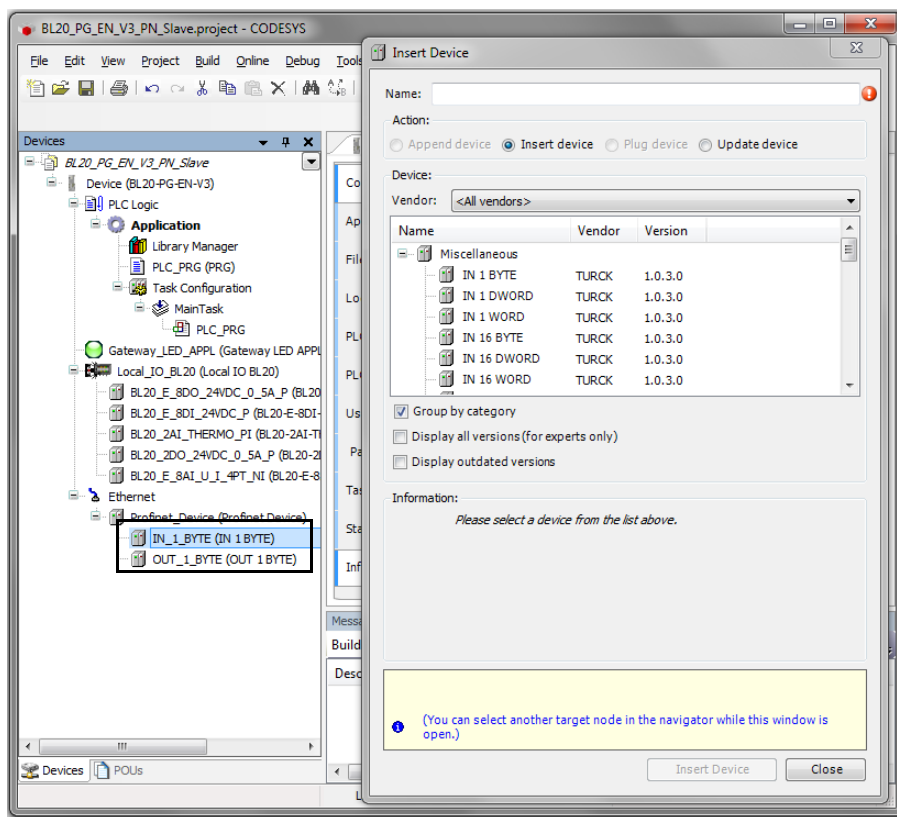

Fig. 34: Configuring the PROFINET-device in CODESYS



NOTE

When configuring the I/O-data the following has to be observed: The input data in CODESYS have to be configured as output data in the PROFINET-master configuration and the output data in CODESYS as input data. The data thus have to be configured in reverse order in the PROFINET-master configuration (see also **Configuring the in- and output data (page 55)**).

Which data will be mapped into the configured input and output data, depends on assignments in the PLC program or in the I/O mapping of the PG-V3 or of the local I/Os.

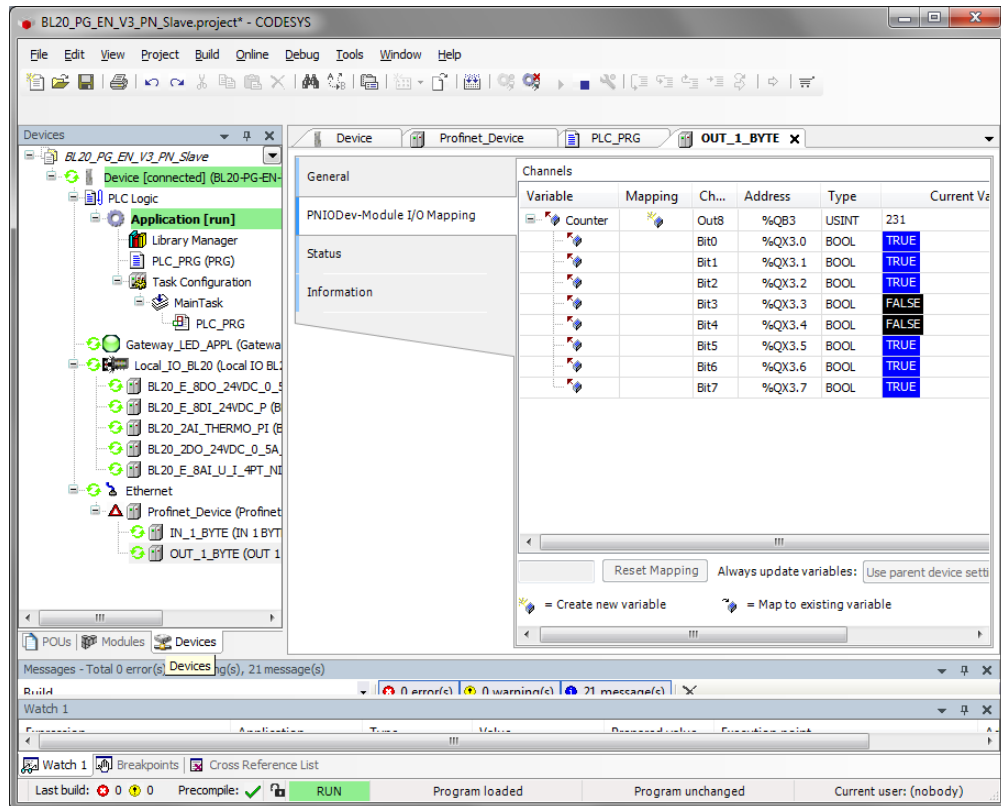

Fig. 35: PROFINET-device data mapping



NOTE

The PROFINET-device shows an error as long as a connection to the PROFINET-master is established.

5.5.2 Configuring the PROFINET-device in the PROFINET-master

The following example shows the PROFINET-device configuration in TIA-Portal V13 from Siemens. The PROFINET-CODESYS-device is configured as standard PROFINET-slave in TIA-Portal.

Hardware in the example:

- PLC: S7 CPU315-2 PN/DP, 315-2EH1 3-0AB0
- BL20-PG-EN-V3, FW 1.0.5.0

Installing the GSDML-file

- Install the device's GSDML-file (GSDML-V2.3-TURCK-CDS3_PN_Device-...-...xml) in the PROFINET configuration software. It can be downloaded from www.turck.com
- The device is added to the hardware catalog „CDS 3 PN Device“.

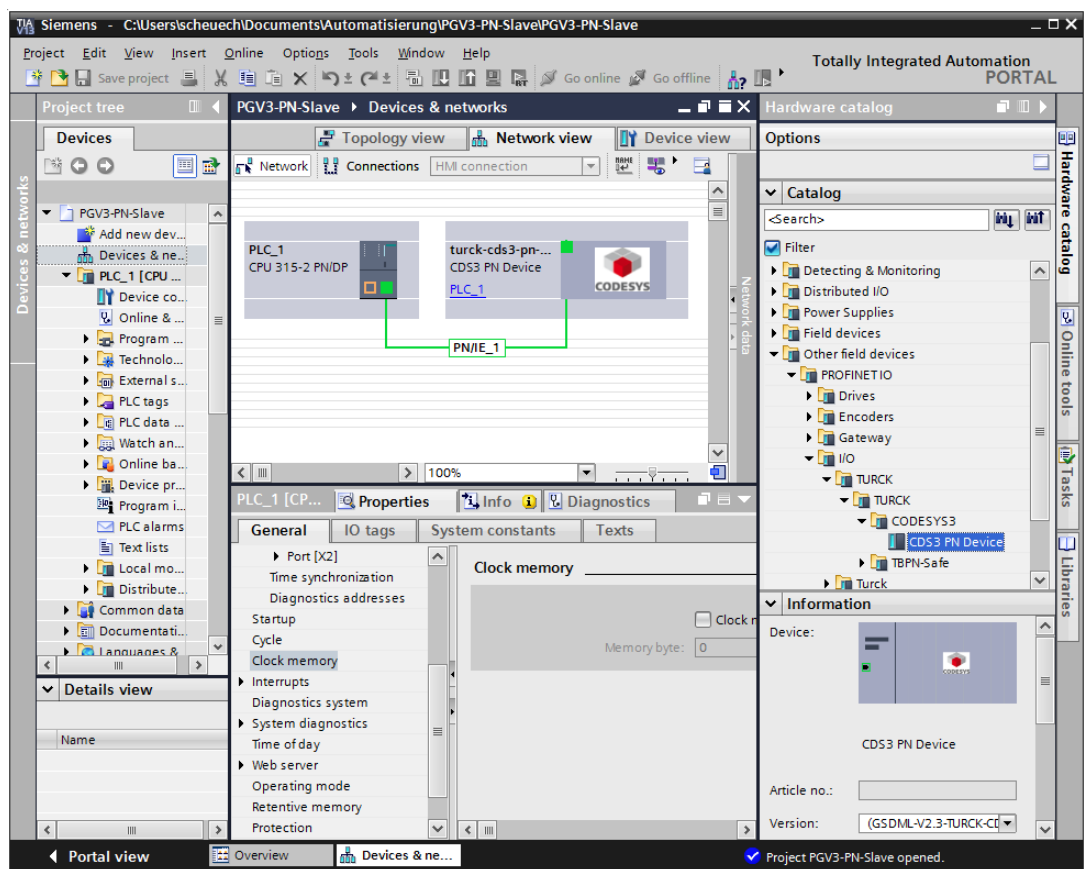

Fig. 36: Configuring the PROFINET-device in TIA-Portal

Configuring the PROFINET-parameters

Like for all other PROFINET-slave, the PROFINET-interface has to be configured for the CDS3 PN-Device" in the project.

- Set all necessary IP-settings and assign a PROFINET-device name or use the device name which has already been assigned to the device.

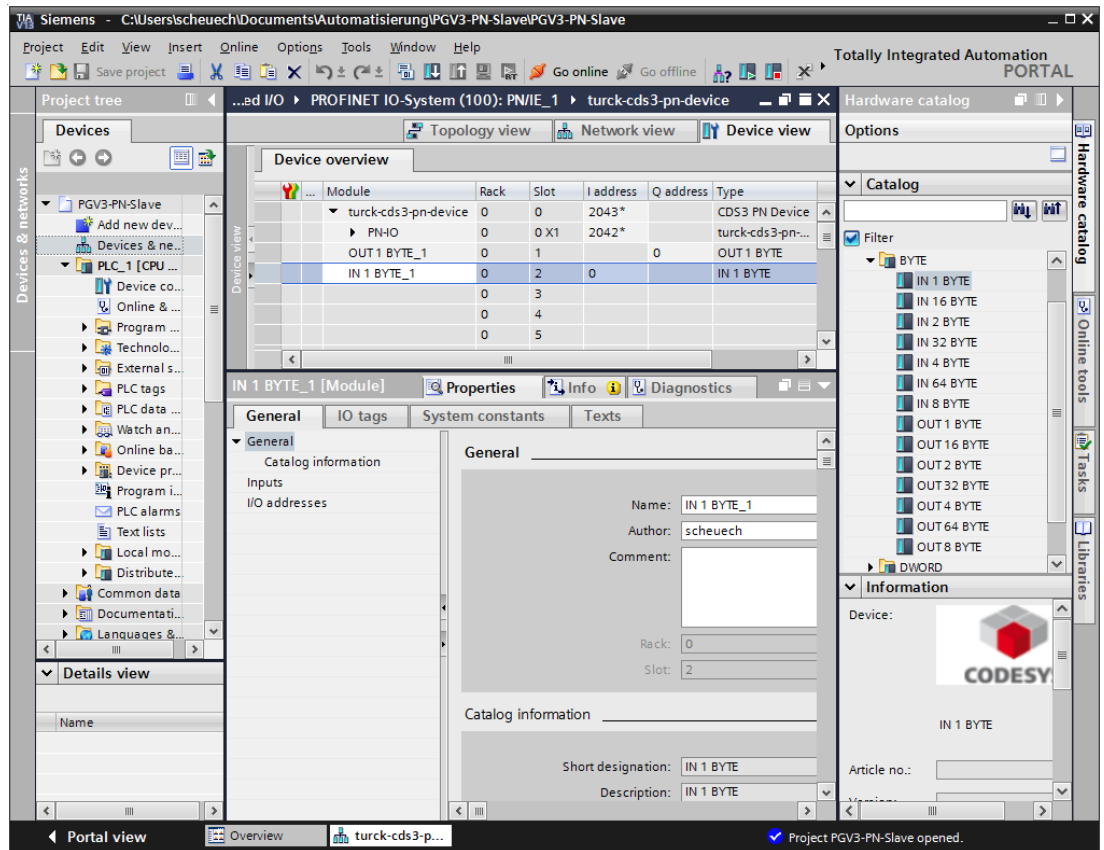

Fig. 37: Settings PROFINET-interface (CDS3 PN Device)

Configuring the in- and output data

- Configure the in- and output data, which have to be exchanged with the CODESYS-device.



NOTE

The configuration of the data in TIA-Portal has to be done in reverse order compared to the configuration in CODESYS. Input data in TIA-Portal are output-data in CODESYS, and vice versa.

The configured data lengths have to match.

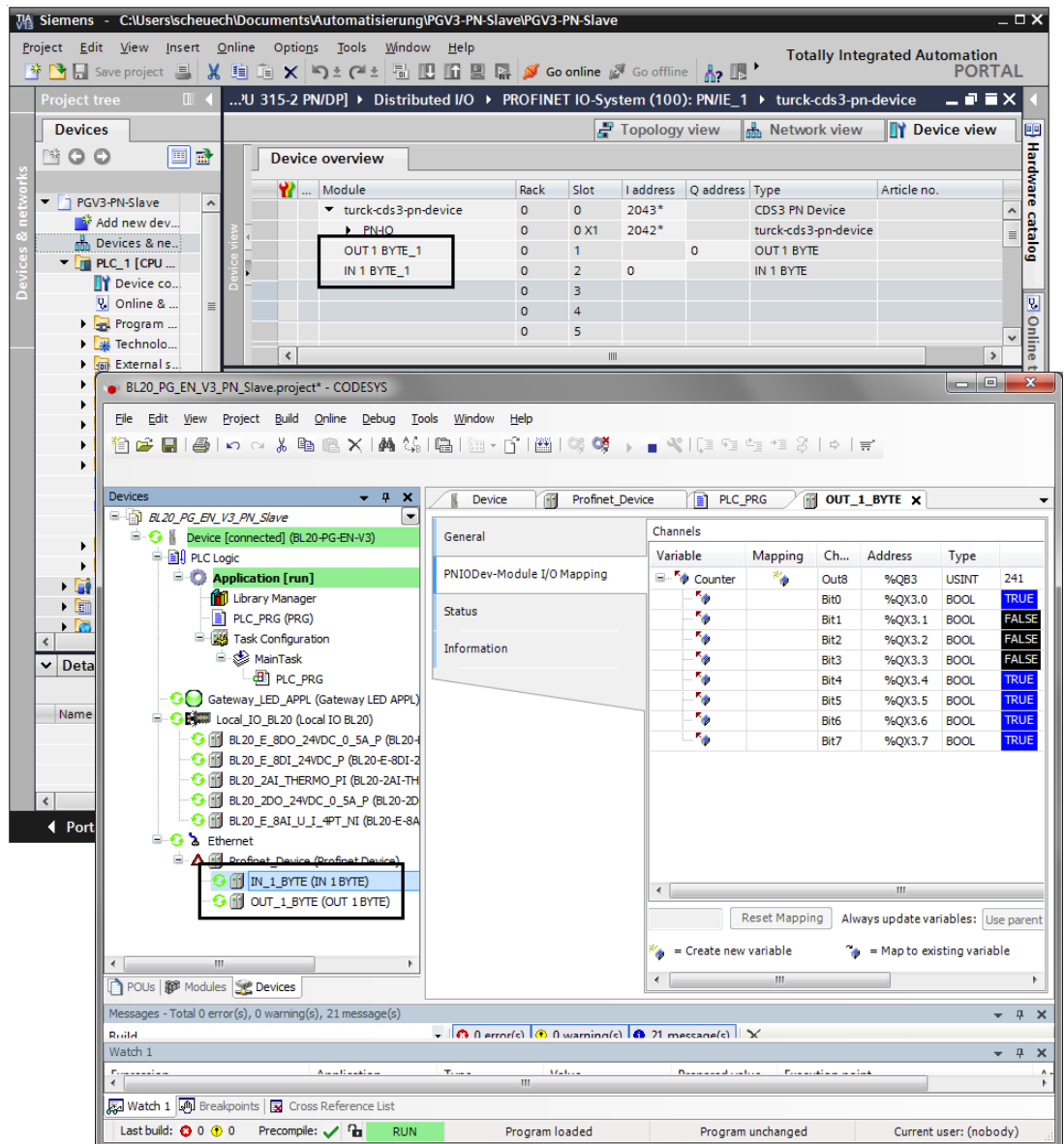

Fig. 38: Configuration of in- and output data in TIA-Portal/CODESYS

5.6 EtherNet/IP Slave (Device)

Properties

max. number of I/O data	496 Byte IN 492 Byte OUT
-------------------------	-----------------------------

5.6.1 Configuring the EtherNet/IP-device in CODESYS

- Add the Ethernet_IP_Slave to the Ethernet interface using the "Add Device"-function and configure the length of the in- and output data, which have to be exchanged with the higher-level EtherNet/IP-PLC.

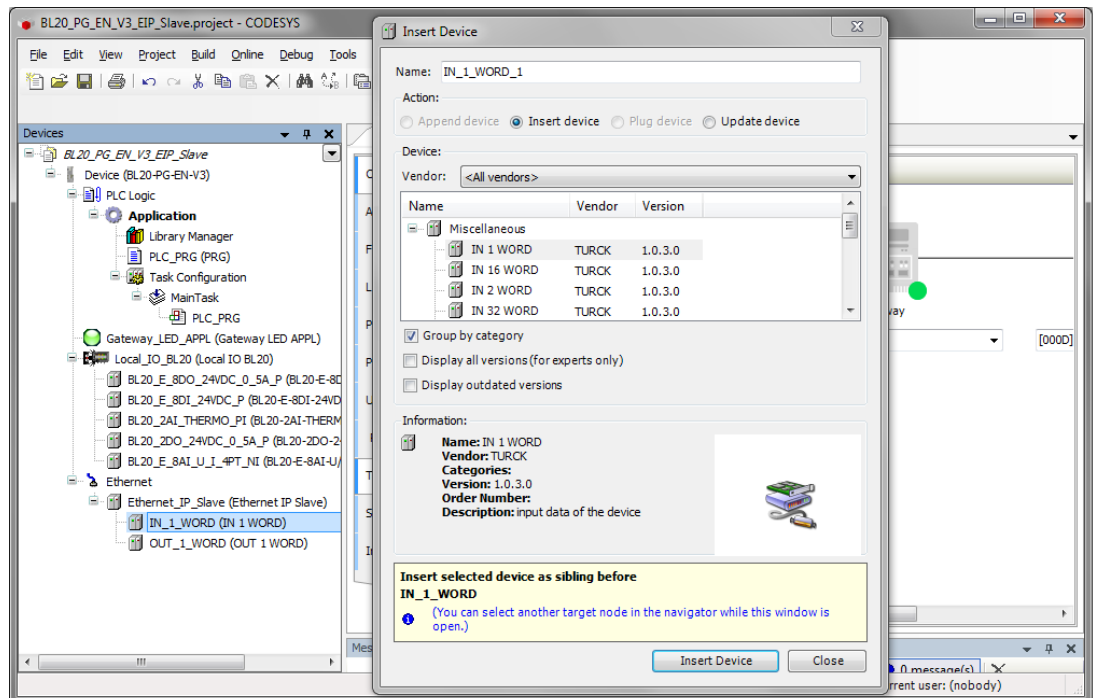

Fig. 39: Configuring the Ethernet/IP-slave

Which data will be mapped into the configured input and output data, depends on assignments in the PLC program or in the I/O mapping of the PG-V3 or of the local I/Os.

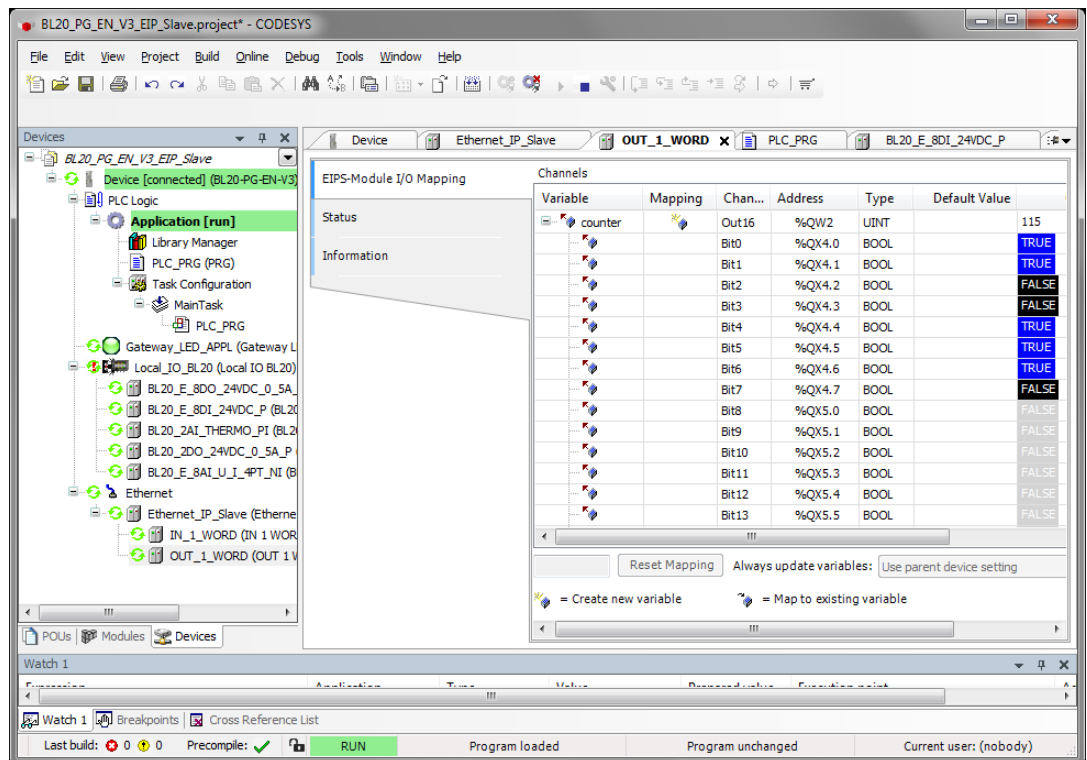

Fig. 40: EtherNet/IP-slave data mapping

5.6.2 Configuring the EtherNet/IP-slave in EtherNet/IP PLC

The following example describes the configuration of the EtherNet/IP-slave in "RSLogix5000" V20.1. from Rockwell Automation.

The EtherNet/IP-slave is configured as standard EtherNet/IP-slave (Communications Adapter) in RSLogix.

Hardware in the example:

- Controller. Logix 5572 (Allen Bradley)
- EtherNet/IP-Bridge 1756EN2TR (Allen Bradley)
- BL20-PG-EN-V3, FW 1.0.5.0

Installing the EDS-file

- Install the device's EDS-file (Turck CDS3.eds) in the configuration software. It can be downloaded from www.turck.com
- ➡ The device is added to the device catalog in RSLogix as „CDS 3 Ethernet/IP Slave“.

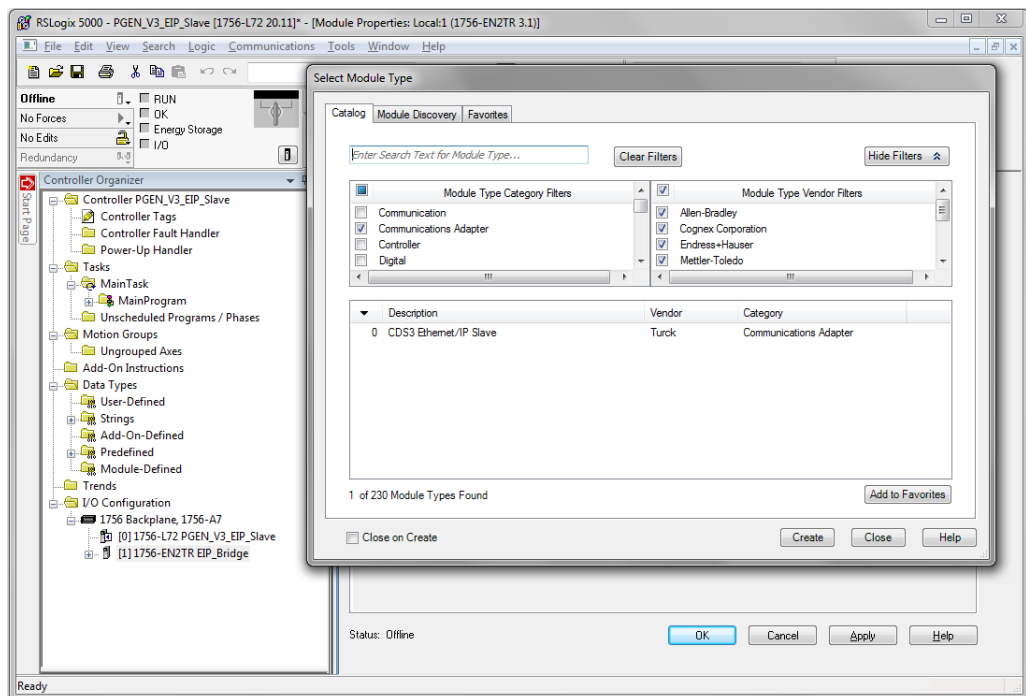

Fig. 41: "CDS 3 Ethernet/IP Slave" in the device catalog in RSLogix5000

Slave configuration

- Enter the device name and the device's IP address.

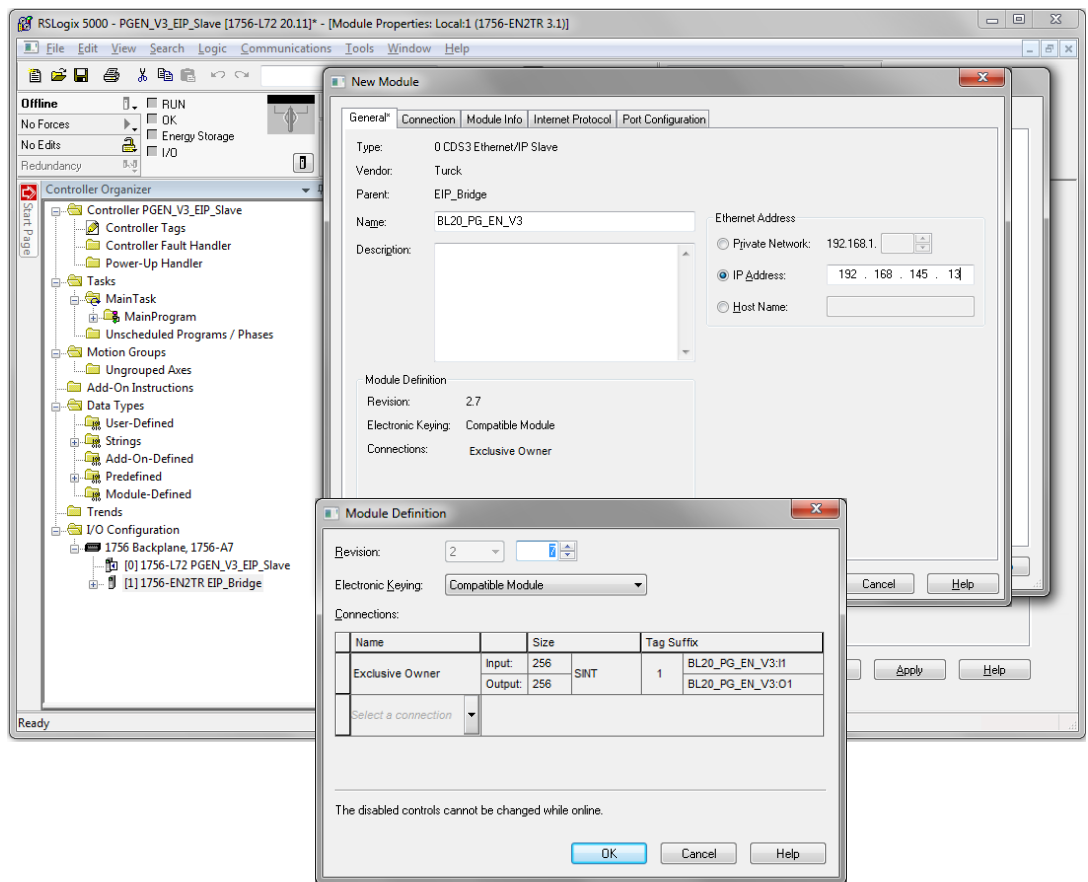

Fig. 42: Settings at the "CDS3 Ethernet/IP Slave"

Configuring the in- and output data

The device is automatically configured with a data width of 256 byte in- and 256 byte output data.

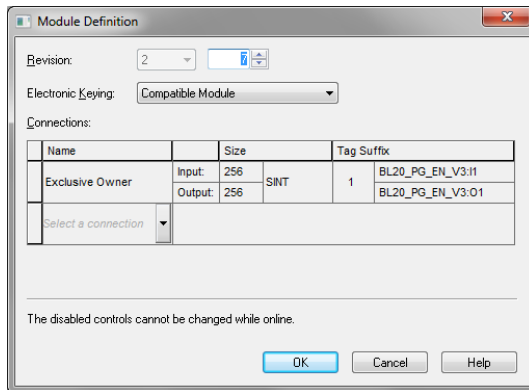

Fig. 43: EtherNet/IP-Connection "CDS3 Ethernet/IP Slave"

Configuring the in- and output data which have to be exchange with the CODESYS-device is thus not necessary. The Controller Tags are automatically generated.

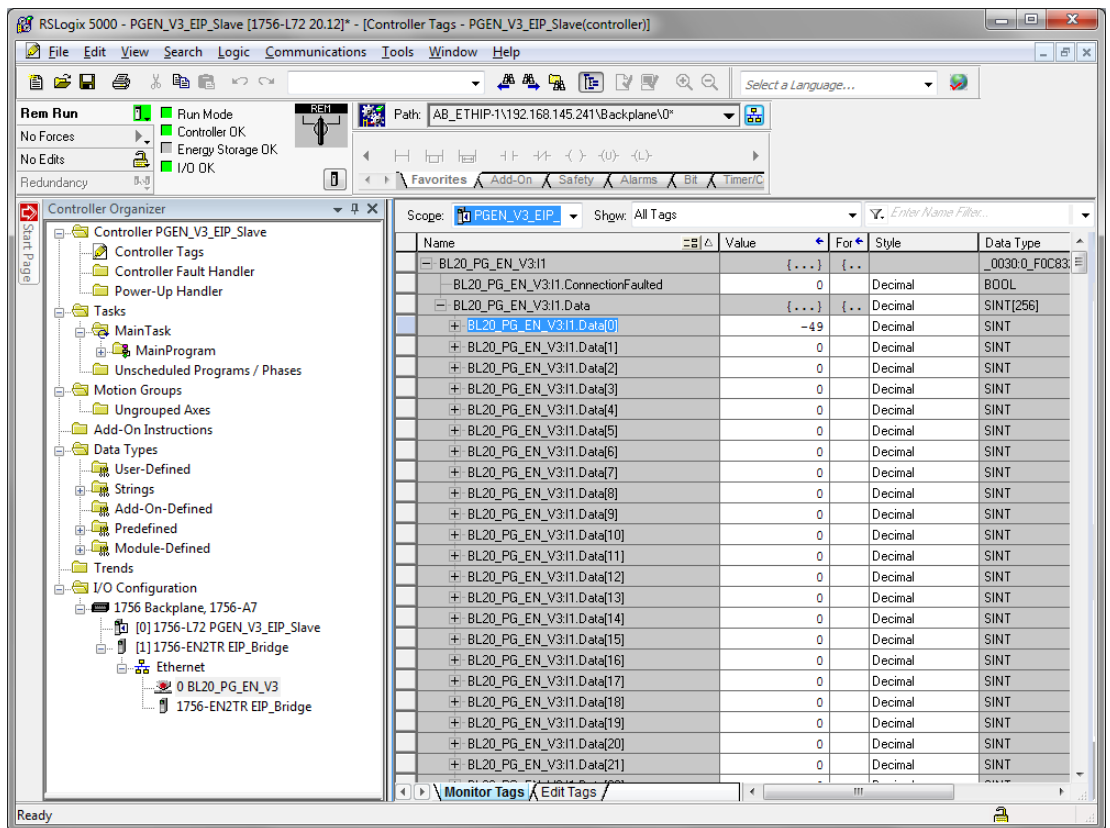

Fig. 44: Automatically generated Controller Tags of the "CDS3 Ethernet/IP Slave"

6 USB Host port functions

The USB Host port serves for connecting USB storage devices for the storage, restore and transfer of CODESYS applications as well as for updating the device firmware.



NOTE

The USB Host function can be deactivated using the web-server of the CODESYS program (bit 14 of the device parameter object).

6.1 Compatible storage devices

The USB Host port is generally suitable to connect commercially available USB storage devices.



NOTE

Only use USB memory sticks formatted to FAT or FAT32. The use of memory sticks formatted to NTFS is not possible.

Depending on the current consumption of the devices, compatibility problems may occur in isolated cases.

In order to guarantee error-free operation, we recommend to use industrially tested storage devices. Ident-Nr. 6827348 - USB 2.0 Industrial Memory Stick.



NOTE

Connecting other USB devices like for example hard disks, keyboards, computer mouses etc. is not possible.

6.2 Functions of the USB Host port

For further information, see **Function overview (page 63)**.

- Read access
 - The read access does not require a user intervention. The CODESYS program continues to run.
 - BACKUP_1: Storing the CODESYS application on the storage device
 - BACKUP_2: Storing the CODESYS application and further device data on the storage device
 - USB_DATA: Storing of CODESYS recipes and/or log-files on the storage device.
- Write access
 - The write requires user intervention (press the SET-button for at least 3 seconds). The CODESYS program is stopped.
 - RESTORE_1: Loading the CODESYS application from the storage device to the device.
 - RESTORE_2: Loading the CODESYS application and further device from the storage device to the device.
 - USB_DATA_WRITE: Loading of CODESYS recipes and/or log-files from the storage device to the device
 - FW_UPDATE

6.2.1 General hints/prerequisites

- The storage device is formatted in FAT (FAT or FAT32).
- The storage device does contain only **one** folder. If the storage device contains more than one folder, not function is executed. The RUN-LED displays errors, see **Behavior of the RUN-LED in case of an error (page 66)**.
- The folder name defines the function to be executed (for further information, see **Function overview (page 63)**).
- Folder names must not contain special characters.
- Boot application:
The names of the CODESYS-application and the file names of the boot application (*.app and *.crc) have to be identical and must not be renamed.
- Read access:
Press the SET-button within 30 seconds after having plugged the storage device. If not, the function is not executed an the storage device is unmounted.



NOTE

The storage device must not be plugged during normal operation. A restart or reset of the device with the storage device being plugged can destroy the running application.



NOTE

Unplug the storage device only if the RUN-LED flashes orange (read/write operation finished) or red/green (error).

6.2.2 Function overview



ATTENTION!

Using CODESYS recipes

Corrupt data due to manipulation of data in USB_Data file directory

► Only use 1:1-copies with Backup_2/Restore_2 when using recipes:

Function	Folder name	Description	CODESYS-program	autom. device restart
Read access				
Backup 1	BACKUP_1	Storing the CODESYS application on the storage device. The following files are stored to the storage device. – All *.app and *.crc files. – PlcLogic folder Existing files with the same name will be overwritten. All other data remain unchanged.	RUN	NO
Backup 2	BACKUP_2	Storing the CODESYS application and the device data on from the BLxx-PG-EN-V3 on the storage device. The following files are stored to the storage device. – All *.app and *.crc files. – PlcLogic folder – Folder USB_Data – IP address – PROFINET device name – Retain-data (retain.bin) Existing files with the same name will be overwritten. All other data remain unchanged.	RUN	NO
Read user data	USB_DATA	Storing the folder "USB_Data" from the BLxx-PG-EN-V3 to the storage device. The following files are stored to the storage device. – CODESYS recipes and/or Log files Existing files with the same name will be overwritten. All other data remain unchanged.	RUN	NO
Write access				
Restore 1	RESTORE_1	Loading the CODESYS application from the storage device into the device. The following files are loaded from the storage device to the device: – All *.app and *.crc files. – PlcLogic folder The folder must contain only one application file (*.app). All other applications on the device are deleted without further warnings. The device automatically executes a restart after unplugging the storage device.	STOP	YES

Function	Folder name	Description	CODESYS-program	autom. device restart
Restore 2	RESTORE_2	<p>Loading the CODESYS application and further device from the storage device into the BLxx-PG-EN-V3.</p> <p>The following files are loaded from the storage device:</p> <ul style="list-style-type: none"> - All *.app and *.crc files. - PlcLogic folder - Folder USB_Data - IP address - PROFINET device name - Retain-data (retain.bin) <p>The folder must contain only one application file (*.app). All other applications on the device except for the retain data are deleted without further warnings. The retain data will only be overwritten if the storage device contains a newer file. The device automatically executes a restart after unplugging the storage device.</p>	STOP	YES
Firmware update	FW_UPDATE	<p>Update of the device firmware. The IP address, the PROFINET device name and the CODESYS application will not be overwritten.</p> <p>File name: BLxx-PG-EN_1234567_Vx.y.z.0.bin</p> <p>The device automatically executes a restart after unplugging the storage device.</p>	STOP	YES
Write user data	USB_DATA_WRITE	<p>Loading the folder "USB_Data" from the storage device into the device.</p> <p>Existing files with the same name will be overwritten. All other data remain unchanged.</p>	STOP	YES

6.2.3 Executing the functions

BACKUP_1/BACKUP_2

- Plug the storage device into the USB Host port.
- ↳ The RUN-LED flashes with 4 Hz.
- ↳ The backup is executed.
- ↳ The RUN-LED flashes orange with 1 Hz.
- ↳ The backup is completed.
- Unplug the storage device.

USB_DATA

- Plug the storage device into the USB Host port.
- ↳ The RUN-LED flashes with 2 Hz.
- ↳ The data are stored to the storage device.
- ↳ The RUN-LED flashes orange with 1 Hz.
- ↳ The storing is completed.
- Unplug the storage device.

RESTORE_1/RESTORE_2

- Plug the storage device into the USB Host port.
- ↳ The RUN-LED flashes with 0.5 Hz.
- Press the SET-button within the next 30 seconds for at least 3 seconds.
- ↳ The RUN-LED flashes in the following order **2x green - pause (1 Hz) - 2 x green- pause (1 Hz) -**
- ↳ Loading of data is executed.
- ↳ The RUN-LED flashes orange with 1 Hz. The loading is completed.
- Unplug the storage device.
- ↳ The device is automatically restarted.

FW_UPDATE

- Plug the storage device into the USB Host port.
- ↳ The RUN-LED flashes with 0.5 Hz.
- Press the SET-button within the next 30 seconds for at least 3 seconds.
- ↳ The RUN-LED flashes in the following order **3x green - pause (1 Hz) - 3 x green- pause (1 Hz) -**
- ↳ Loading of data is executed.
- ↳ The RUN-LED flashes orange with 1 Hz. The firmware update is completed.
- Unplug the storage device.
- ↳ The device is automatically restarted.

USB_DATA_WRITE

- Plug the storage device into the USB Host port.
- ↳ The RUN-LED flashes with 0.5 Hz.
- Press the SET-button within the next 30 seconds for at least 3 seconds.
- ↳ The RUN-LED flashes with 2 Hz. The data are stored to the BLxx-PG-EN-V3.
- ↳ The RUN-LED flashes orange with 1 Hz. The storing is completed.
- Unplug the storage device.
- ↳ The device is automatically restarted.

6.2.4 Behavior of the RUN-LED in case of an error

Error	Description	LED behavior
Timeout	– The SET-button has not been pressed within the 30 seconds after the plugging of the storage device.	Red/green flashing (1 Hz)
Invalid folder	– The storage device contains one folder with an invalid folder name. – The storage device contains several folders with valid folder names.	
Empty folder	– The storage device contains one valid , but empty folder.	
USB deactivated	– The USB Host function has been deactivated using via web-server or CODESYS program.	Red/green flashing (0.5 Hz)

7 The web server

7.1 Web server - remote access/configuration

7.2 Safety in the web server

In the web server, a default-password is assigned to the Turck devices for the administrator access.

We strongly recommend to use an individual password, in order to avoid possible misuse by a third party!

This should be done in the context of the network security concept for the complete facility in which the modules are placed.

**NOTE**

Please change the password as described in **Change Admin Password (page 71)**.

**NOTE**

The password is transferred as plain text.

7.3 IP address

In the delivery status, neither an address nor a PROFINET name is stored in the devices.

In order to be able to access the device via web server, the web server can be opened using the IP address 192.168.1.254.

If the PC used for the configuration is situated in the same IP network, page

<http://192.168.1.254>

can be opened in order to initially change some settings.

7.4 Home

The web server's start page shows general device information, network settings, etc.

The „PLC Information“ part contains information concerning the CODESYS program status.

The menu items "Station Diagnostics", "Ethernet Statistics" and "Links" can also be accessed read-only without an administrator access.

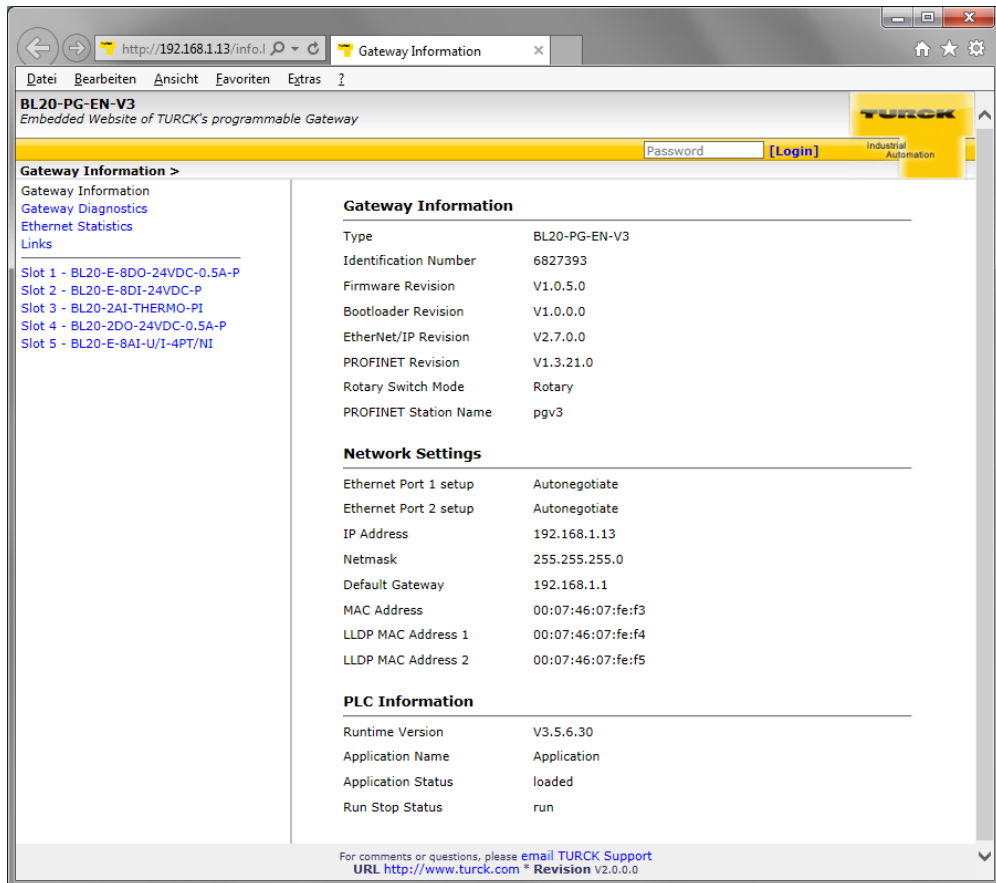

Fig. 45: Start page of the web server of BL20-PG-EN-V3

7.5 Gateway Diagnostics

Diagnostic messages of the device are displayed on the "Station Diagnostics"-page.

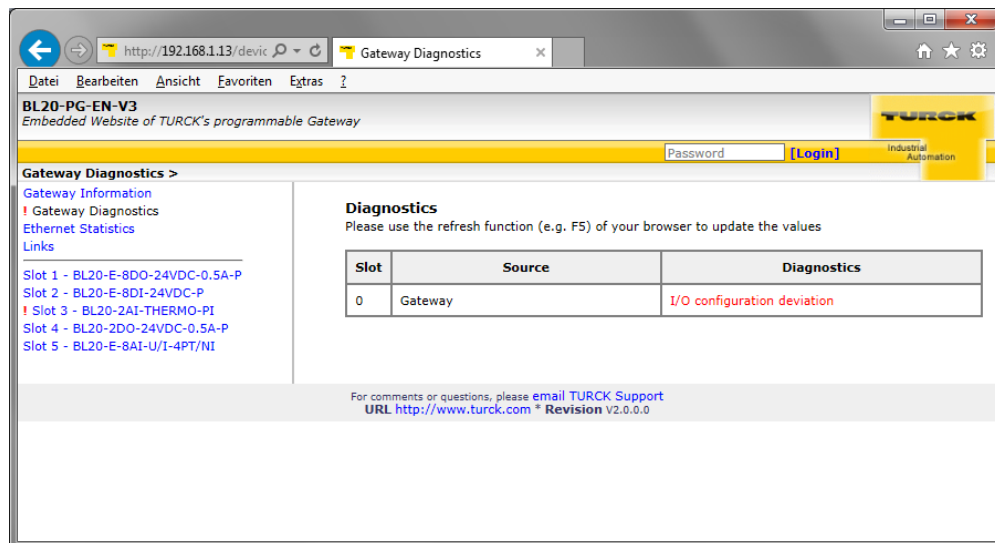

Fig. 46: Diagnostics in the web server

7.6 Ethernet Statistics

The page "Ethernet Statistics" shows information like the port-status, telegram and error counters etc. The page can above all be useful for analyzing network problems.

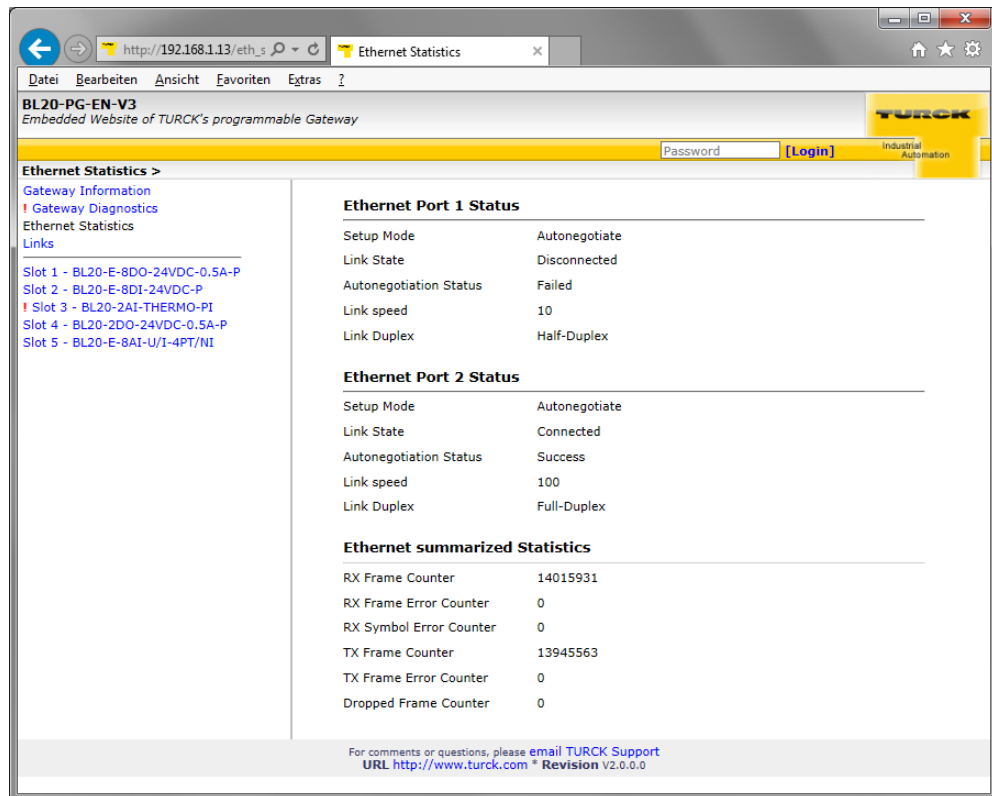

Fig. 47: Ethernet Statistics



NOTE

The "Ethernet summarized statistics" contain the statistics for both Ethernet ports.

7.7 Links

This page contains for example a link to the product page on the TURCK-homepage.

7.8 Login/password

In order to obtain administrator rights and thus full access to the extended functions of the web server (Network Configuration, Station Configuration, etc.), you have to log-on to the web server as administrator.

For the first login use the default password "password".

The default-password should be be changed by the administrator. To do so, please follow the instructions under **Change Admin Password (page 71)**.



NOTE

Executing the „Reset to Factory Defaults“ also resets the password to "password".

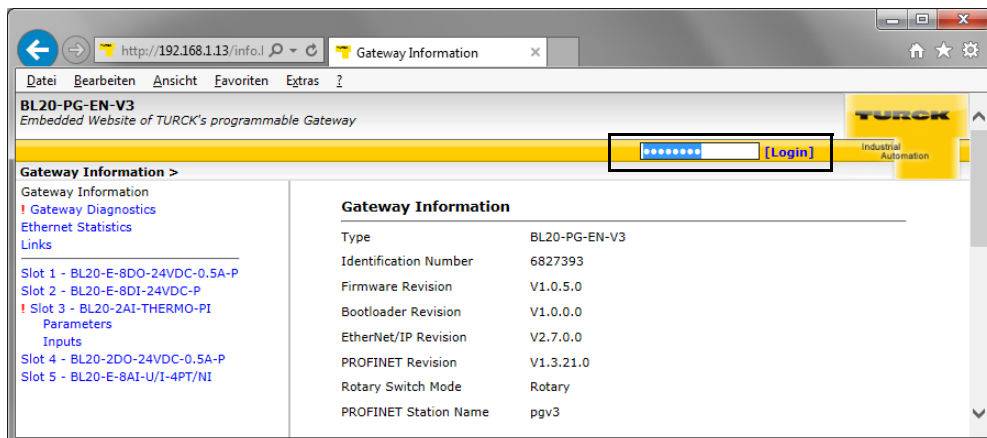

Fig. 48: Web server „password“

7.9 Change Admin Password



NOTE

For security aspects when working with the web server, please observe the notes under **Safety in the web server (page 67)**.



NOTE

The password for the web server is synchronized to the password for the SFTP access. Changing the web server password also changes the see password for the SFTP access (page **page 36**).

Please define an individual password for administrator rights.

Default password: „password“



NOTE

Executing the „Reset to Factory Defaults“ (see also **Reset to Factory Defaults (page 74)**) also resets the password to "password".

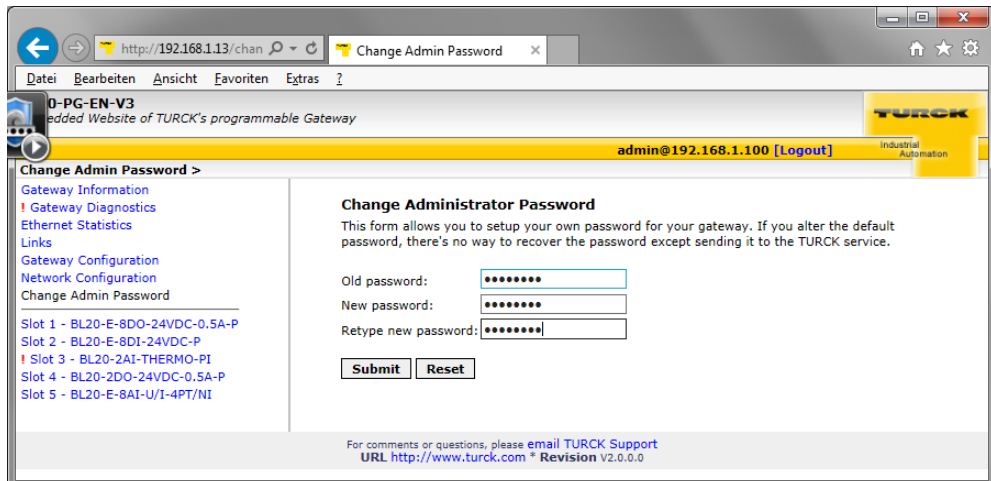

Fig. 49: Change Admin Password

Change password

- Change the password for the station in the web server.
- Write the changes into the device via "Submit".
- Restart the device (voltage reset or pressing the set-button).
- ➔ The device has accepted the new settings, the settings have become active.



NOTE

"Reset" only resets the changes done in the web server mask back to the original values. The function does not influence the device itself.

7.10 Network Configuration

On the "Network Configuration"-page, network-relevant settings can be changed.

7.10.1 Change network parameters (port settings, IP address, etc.)

The device's network settings can be changed under "Network Configuration" only by users having administrator rights.



NOTE

The access of the web server to the station is only possible, if the station already has an IP address, **Device addressing and operation mode setting (page 19)**.

After a reset to factory settings, the device can be accessed using the IP address 192.168.1.254. This IP address is not stored permanently in the device.

If the device is set to "ROTARY" mode (**Address setting via rotary coding switches (Static rotary) (page 20)**), than the last byte of the IP address can not be changed via the web server.

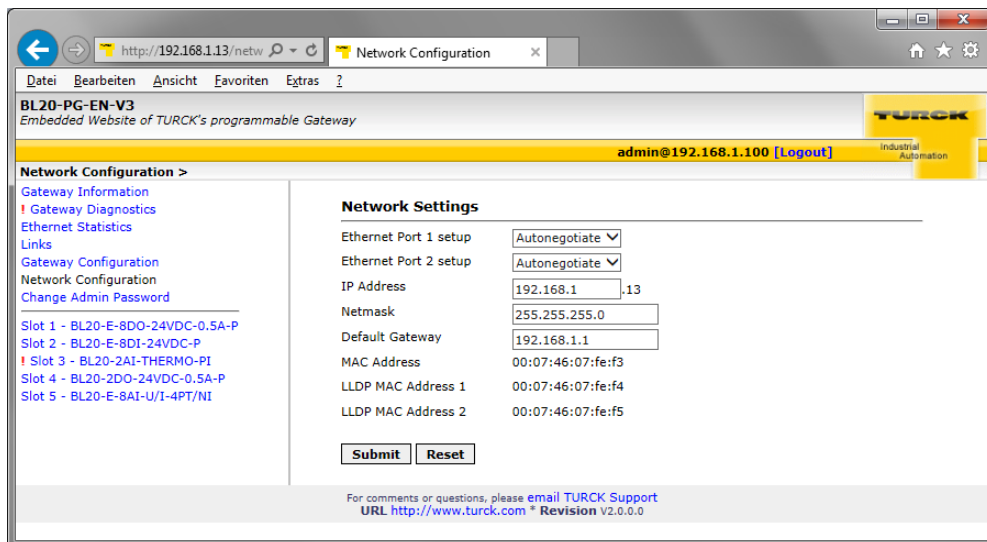

Fig. 50: Web server with Network Configuration

Change network parameters

- Change the network parameters in the web server.
- Write the changes into the device via "Submit".
- ➔ The device has accepted the new settings, the settings have become active.



NOTE

"Reset" only resets the changes done in the web server mask back to the original values. The function does not influence the device itself.

7.11 Gateway Configuration

7.11.1 Configuration of the field bus interface

The "Gateway Configuration"-page serves for parameterizing the device's fieldbus interface:

- Deactivating the USB Host port or the web server
- Assigning a PROFINET device name

7.11.2 Reboot

"Reboot" executes a power-cycle at the device.

7.11.3 Reset to Factory Defaults

Resets the device to the default settings (factory settings), see also **F_Reset (Reset to factory setting) (page 23)**.

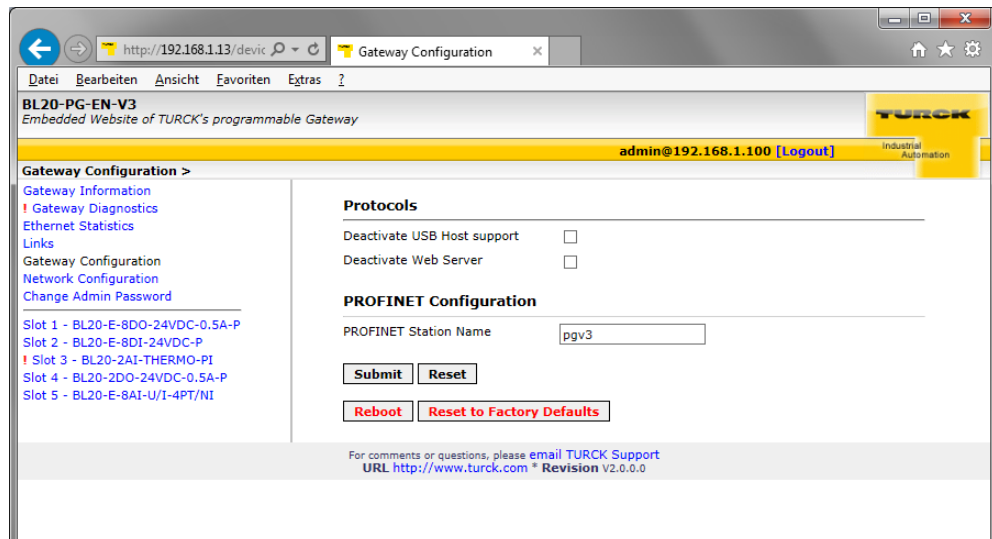

Fig. 51: Web server „Gateway Configuration“

Gateway Configuration

- Change the configuration in the web server.
- Write the changes into the device via "Submit".
- ➔ The device has accepted the new settings, the settings have become active.



NOTE

"Reset" only resets the changes done in the web server mask back to the original values. The function does not influence the device itself.

7.12 Slot Parameters

7.12.1 Parameterization of the in-/ outputs

The "Parameters"-page is used to parameterize the module's I/O-channels.



NOTE

Parameter changes by the web server are valid in the device until the CODESYS program is downloaded to the device again, the device is restarted or parameters are changed in CODESYS by online change.

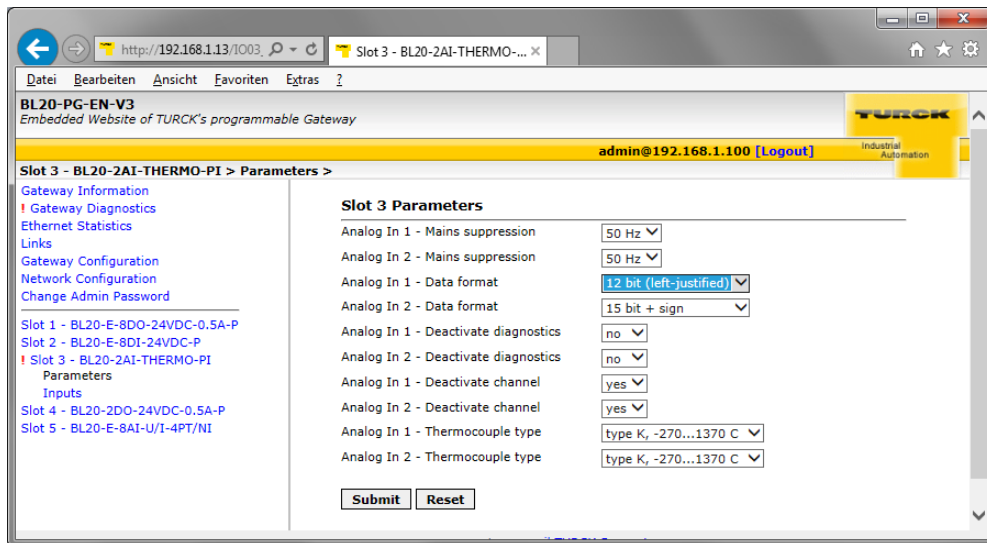

Fig. 52: Web server „Parameters“

Change parameters

- Change the module parameters in the web server.
- Write the changes into the device via "Submit".
- Restart the device (voltage reset or pressing the set-button).
- The device has accepted the new settings, the settings have become active.



NOTE

"Reset" only resets the changes done in the web server mask back to the original values. The function does not influence the device itself.

7.13 Using mobile devices

The internal web server has a responsive design. This means, the web functions can also be executed using a mobile device, e.g. a smartphone.

The web content is automatically adapted to the smaller display in order to assure an optimized web server representation.

The Turck device and the mobile device have to be nodes of the same network. Please assure therefore that the IP addresses of both devices are part of the same subnet (e.g. 255.255.255.0).

In addition to that, a WLAN access has to be available for the mobile device.

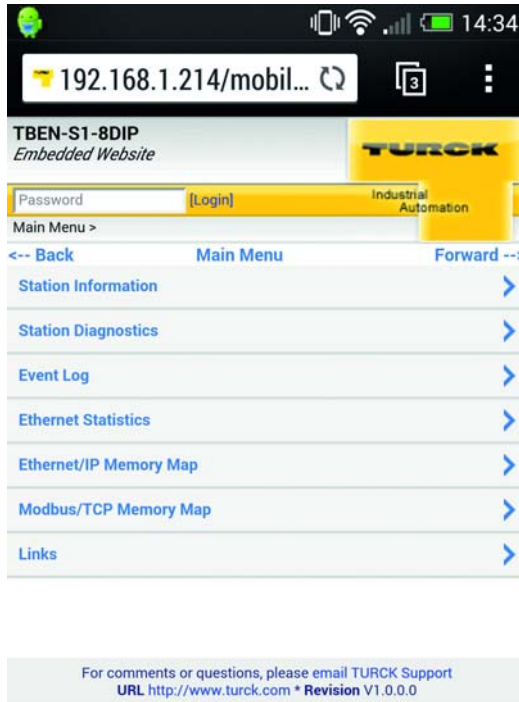

Fig. 53: Access to the web server via smartphone

7.14 Web server logout

In order to disconnect a logged in user/PC with administrator rights from the web server, a logout is necessary.

If only the web browser is closed, the last active access is reactivated when opening the web server again from the same PC, which means, possibly with all administrator rights.

7.15 Deactivating the web server



NOTE

If, for safety reasons, the web server has to be deactivated completely, this is possible via the device parameters in CODESYS or in the web server itself (see [page 74](#)).

If the web server is deactivated using the web server itself, further access to it is only possible following a device reset to the factory settings (see [page 74](#)).

TURCK

...with 28 subsidiaries
and over 60 representations worldwide!

D301373 | 2016/06



www.turck.com