

WLS27 LED Strip Light



Instruction Manual

Banner's WLS27 LED Strip Light has a sturdy aluminum housing and is encased in a shatterproof, UV-stabilized, copolyester shell, making it ideal for harsh indoor and outdoor applications.

- Low-profile, space-saving design
- Rugged, water-resistant IP69K option
- Available in eight lengths from 145 mm to 1130 mm
- Daisy chain power to multiple lights
- Optional snap clips for easy installation and repositioning
- Capability to dim lights using the wiring pinout (Hi/Lo/Off)
- Automatic temperature protection built into the unit. Above 50 °C, the light dims to manage heat and protect product lifetime



Stand-Alone Light or End Light in a Cascade—QD



First or Middle of a Cascade—QD

These Work Light Strips are available as either stand-alone models, or as cascade models that can be "daisy-chained" together for a continuous length of lighting, with a minimum of wiring.

Stand-alone models have a male quick disconnect (QD) at one end for power connection and no connections at opposite end. A stand-alone model may be used as the last in the cascade series.

Cascade models have a male quick disconnect (QD) at one end for power connection, and a female QD at the opposite end for connecting to other lights in the cascade. A double-ended accessory cordset must be used between each pair of lights in a cascade.

Use single-ended cordsets between the power source and the QD connection of a stand-alone light or the first light in a cascade. Use double-ended cordsets between lights in a cascade.



Important: Lea el siguiente instructivo antes de operar el luminario. Por favor descargue desde www.bannerengineering.com toda la documentación técnica de los WLS27 LED Strip Light, disponibles en múltiples idiomas, para detalles del uso adecuado, aplicaciones, advertencias, y las instrucciones de instalación de estos dispositivos.



Important: Lisez les instructions suivantes avant d'utiliser le luminaire. Veuillez télécharger la documentation technique complète des WLS27 LED Strip Light sur notre site www.bannerengineering.com pour les détails sur leur utilisation correcte, les applications, les notes de sécurité et les instructions de montage.

Models

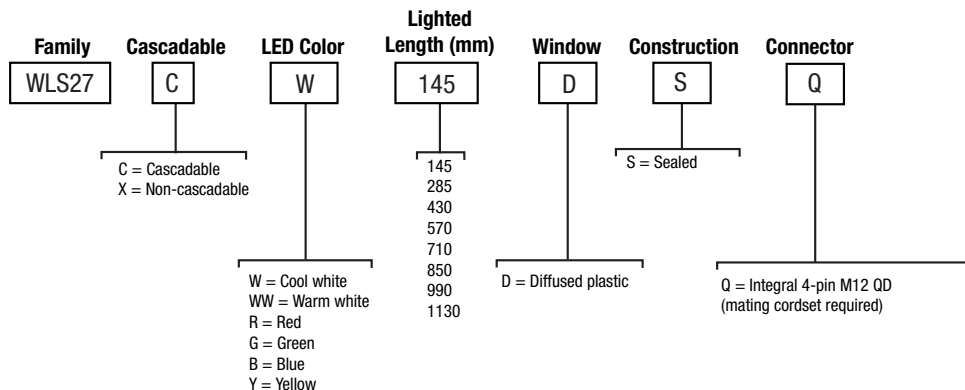

| Models | | Lighted Length | Power Connector |
|----------------|----------------|----------------|--|
| Stand-Alone | Cascade | | |
| WLS27XW145DSQ | WLS27CW145DSQ | 145 mm | Integral 4-pin M12/Euro-style quick disconnect |
| WLS27XW285DSQ | WLS27CW285DSQ | 285 mm | |
| WLS27XW430DSQ | WLS27CW430DSQ | 430 mm | |
| WLS27XW570DSQ | WLS27CW570DSQ | 570 mm | |
| WLS27XW710DSQ | WLS27CW710DSQ | 710 mm | |
| WLS27XW850DSQ | WLS27CW850DSQ | 850 mm | |
| WLS27XW990DSQ | WLS27CW990DSQ | 990 mm | |
| WLS27XW1130DSQ | WLS27CW1130DSQ | 1130 mm | |



Specifications

Supply Voltage

12 to 30 V dc

Use only with a suitable Class 2 power supply (UL) or SELV power supply (CE)

| Light Length | Typical Current | | | Max. Current | Lumens (Typical at 25 °C) | | | | | |
|--------------|-----------------|---------|---------|--------------|---------------------------|------------|-------|-----|--------|------|
| | 12 V dc | 24 V dc | 30 V dc | A | Cool White | Warm White | Green | Red | Yellow | Blue |
| 145 mm | 0.33 A | 0.15 A | 0.12 A | 0.4 | 400 | 400 | 180 | 55 | 50 | 40 |
| 285 mm | 0.66 A | 0.30 A | 0.24 A | 0.8 | 800 | 800 | 360 | 110 | 100 | 80 |
| 430 mm | 1.01 A | 0.46 A | 0.36 A | 1.2 | 1200 | 1200 | 540 | 165 | 150 | 120 |
| 570 mm | 1.36 A | 0.61 A | 0.48 A | 1.6 | 1600 | 1600 | 720 | 220 | 200 | 160 |
| 710 mm | 1.75 A | 0.77 A | 0.60 A | 2.0 | 2000 | 2000 | 900 | 275 | 250 | 200 |
| 850 mm | 2.13 A | 0.92 A | 0.73 A | 2.4 | 2400 | 2400 | 1080 | 330 | 300 | 240 |
| 990 mm | 2.59 A | 1.08 A | 0.85 A | 2.8 | 2800 | 2800 | 1260 | 385 | 350 | 280 |
| 1130 mm | 3.04 A | 1.24 A | 0.97 A | 3.2 | 3200 | 3200 | 1440 | 440 | 400 | 320 |

Supply Protection Circuitry

Protected against reverse polarity and transient voltages

Light Characteristics

Cool white

Color Temperature (CCT): 6500K (+500K, -400K)

Lumen output: 800 (± 5%) per foot, typical at 25 °C (77 °F)

Luminous efficacy: 110 lumens/Watt typical at 24 V dc at 25 °C (77 °F)

CRI: 85, typical

Warm white: 3000K (+200K, -100K)

Green: 525 nm

Red: 618 nm

Yellow: 590 nm

Blue: 460 nm

Application Note

When connecting cascaded lights in series at 100% intensity, it is important not to exceed maximum current limitations:

Maximum length of light at 12 V dc: 1.4 m (4.6 ft)

Maximum length of light at 24 V dc: 3.0 m (9.8 ft)

Maximum length of light at 30 V dc: 3.1 m (10.2 ft)

At 50% intensity, double the lengths.

Certifications



LED Lifetime

Lumen Maintenance - L₇₀

When operating within specifications, output will decrease less than 30% after 75,000 hours.

Construction

Clear anodized aluminum housing; FDA-grade copolyester outer housing

Mounting

Bracket LMBWLS27EC included (2 for lights up to 570 mm or 3 for lights 710 mm and longer)

Connections

Integral 4-pin M12/Euro-style quick disconnect (4-pin connecting cordset required)

Environmental Rating

Rated IEC IP66, IEC IP67, and IP69K per DIN 40050-9

Operating Temperature

-40 °C to +70 °C (-40 °F to +158 °F)

Light output begins to decrease above 50 °C (122 °F) and will be approximately 65% of max intensity at 60 °C (140 °F) and 30% of max intensity at 70 °C (158 °F)

Storage Temperature

-40 °C to +70 °C (-40 °F to +158 °F)

Vibration and Mechanical Shock

Vibration 10-55 Hz 1.0 mm p-p amplitude per IEC 60068-2-6

Shock 15G 11 ms duration, half sine wave per IEC 60068-2-27



Note: Do not spray cable with high-pressure sprayer, or cable damage will result.

Performance

Optical data shown below is for cool white only. To get lux and candela values for other colors, multiply the values shown on the charts by the following factors:

| | |
|--------------------|-------|
| Warm White: | 1.000 |
| Green: | 0.450 |
| Red: | 0.138 |
| Yellow: | 0.125 |
| Blue: | 0.100 |

145 mm Models

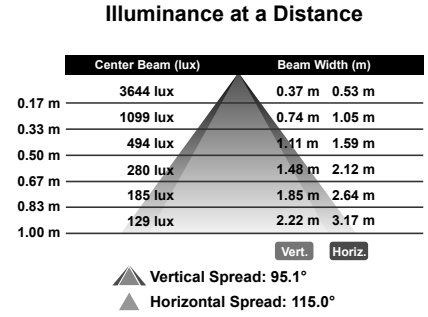
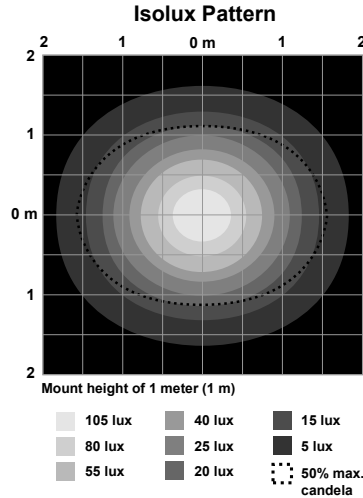
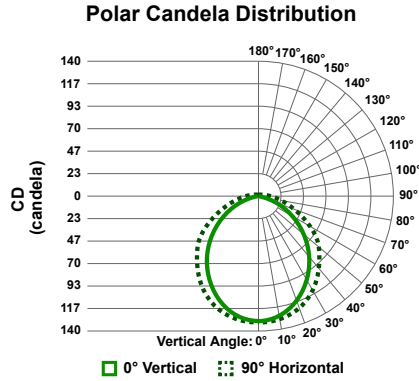

285 mm Models

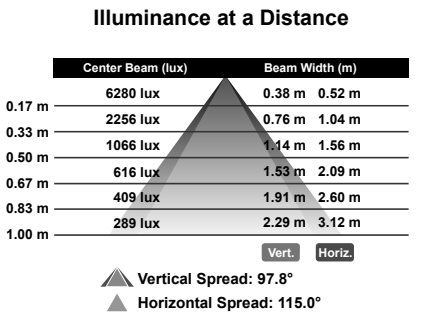
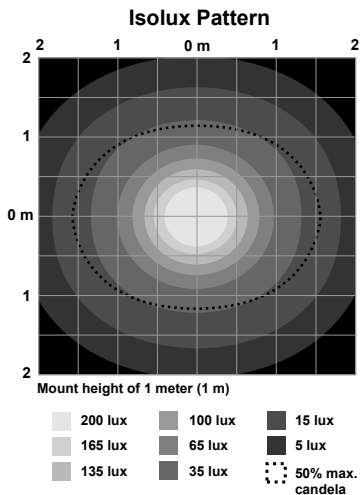
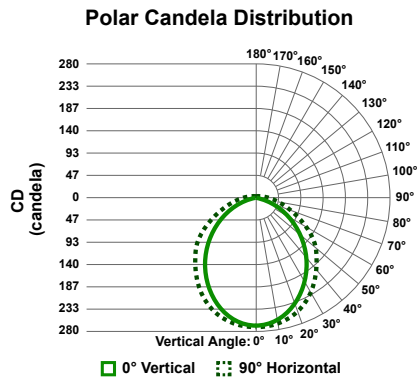

430 mm Models

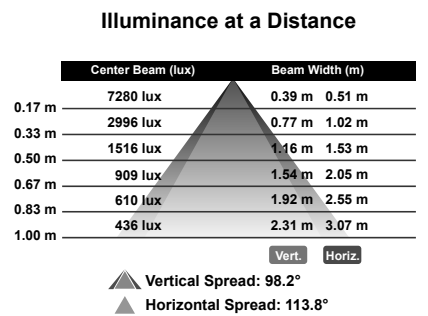
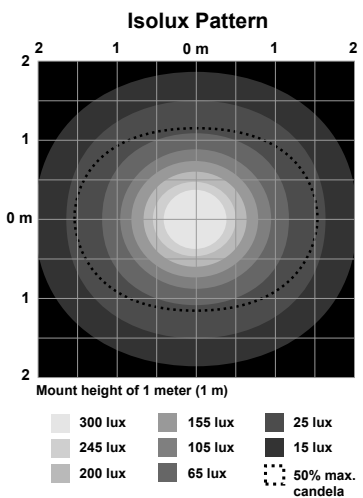
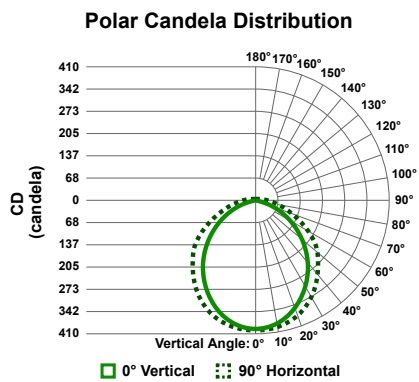

570 mm Models

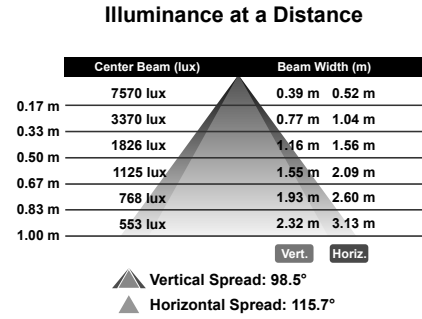
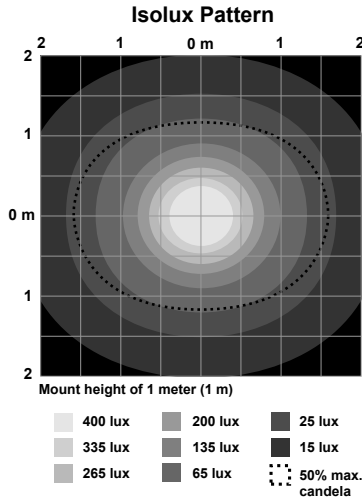
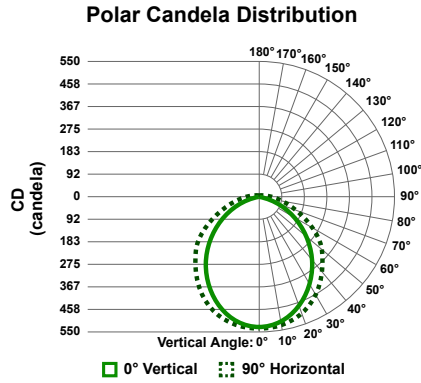

710 mm Models

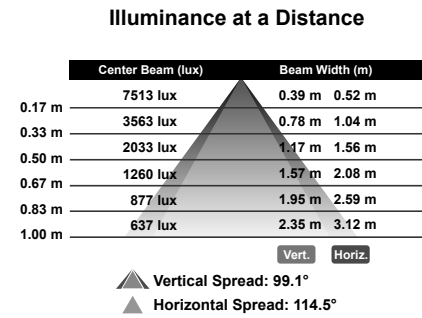
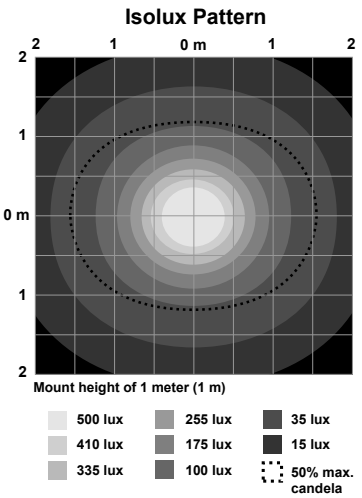
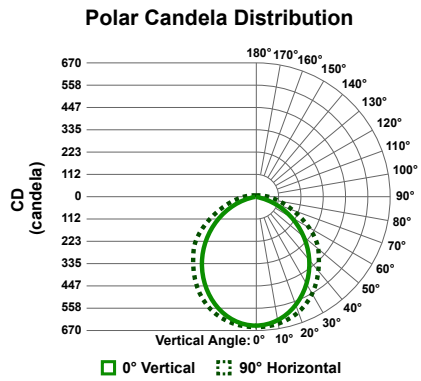

850 mm Models

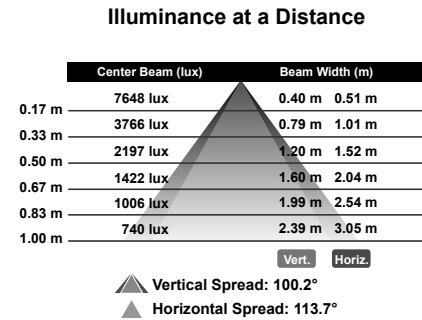
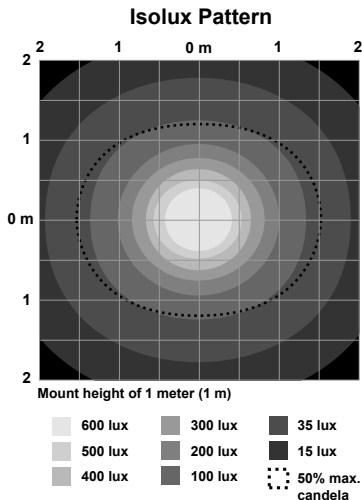
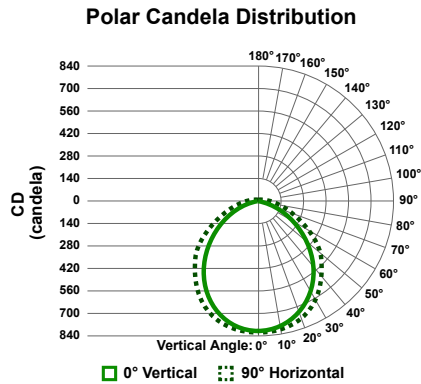

990 mm Models

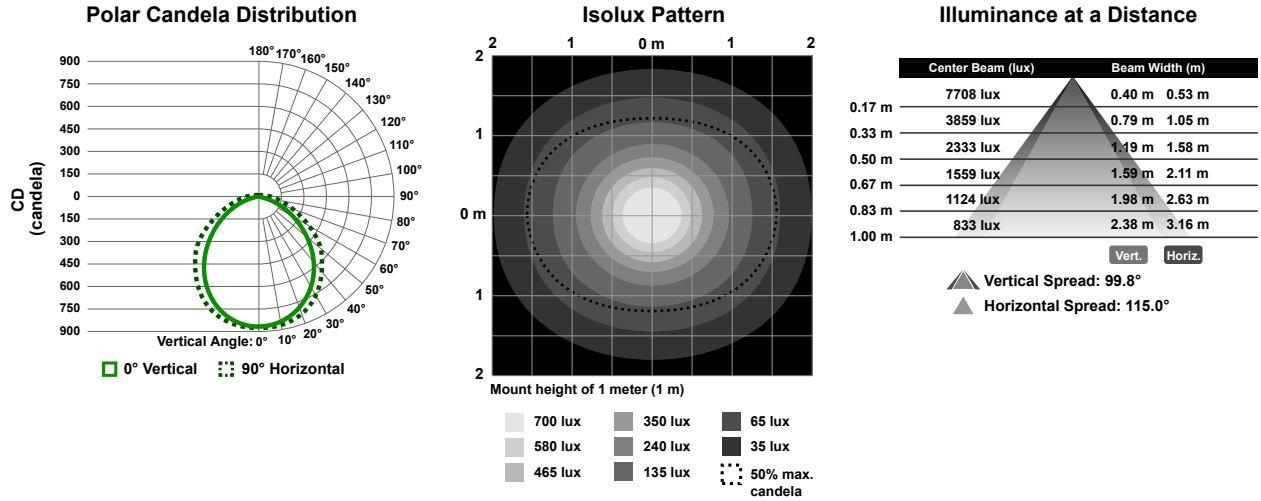

1130 mm Models

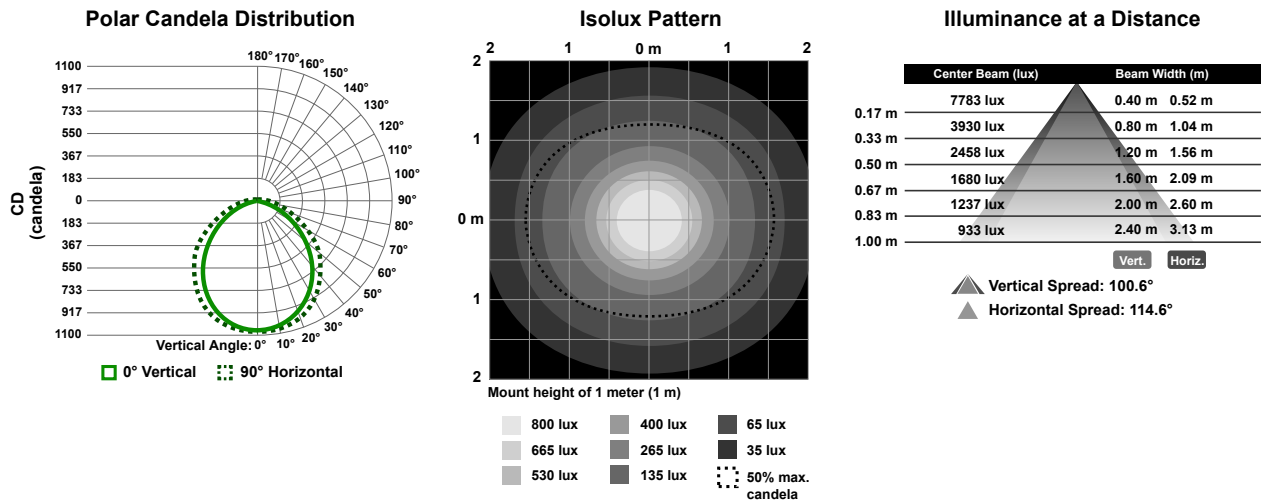

Dimensions

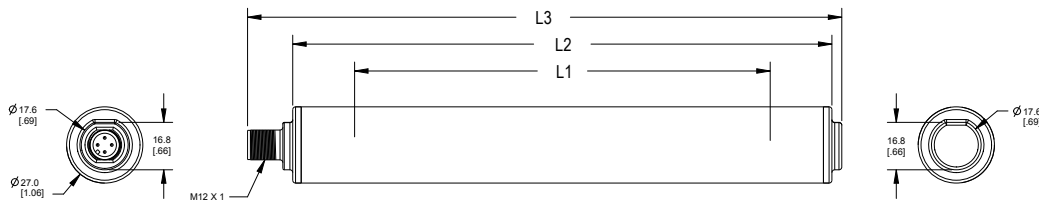

Figure 1. Quick Disconnect Models

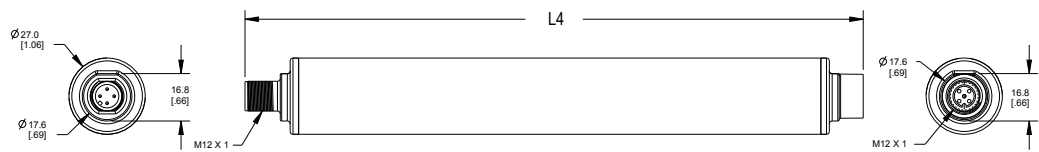
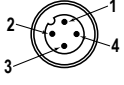

Figure 2. Cascade Models

| Models | L1 | L2 | L3 | L4 |
|--------------|------------------|-----------------|--------------------|------------------|
| WLS27..145.. | 145 mm (5.7 in) | 189 mm (7.4 in) | 208.5 mm (8.2 in) | 217 mm (8.5 in) |
| WLS27..285.. | 286 mm (11.3 in) | 330 (13 in) | 349.5 mm (13.8 in) | 358 mm (14.1 in) |

| Models | L1 | L2 | L3 | L4 |
|---------------|-------------------|-------------------|---------------------|-------------------|
| WLS27..430.. | 427 mm (16.8 in) | 471 mm (18.5 in) | 490.5 mm (13.3 in) | 499 mm (19.6 in) |
| WLS27..570.. | 569 mm (22.4 in) | 612 mm (24.1 in) | 631.5 mm (24.9 in) | 640 mm (25.2 in) |
| WLS27..710.. | 708 mm (27.9 in) | 752 mm (29.6 in) | 771.5 mm (30.4 in) | 780 mm (30.7 in) |
| WLS27..850.. | 849 mm (33.4 in) | 893 mm (35.2 in) | 912.5 mm (35.9 in) | 921 mm (36.2 in) |
| WLS27..990.. | 991 mm (39 in) | 1035 mm (40.8 in) | 1054.5 mm (41.5 in) | 1063 mm (41.8 in) |
| WLS27..1130.. | 1120 mm (44.1 in) | 1164 mm (45.8 in) | 1183.5 mm (46.4 in) | 1192 mm (46.9 in) |

Wiring Diagram

| 4-pin M12/Euro-style male QD | Pin | Wire Color | Connection |
|---|-----|------------|---|
|  | 1 | brown | 12 to 30 V dc |
| | 3 | blue | dc common |
| | 4 | black | Connect to 12 to 30 V dc for 50% maximum intensity. For maximum intensity, leave the black wire floating or connected to common . |
| | 2 | white | Not used |

Accessories

Cordsets

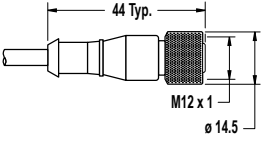
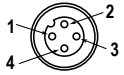
| 4-Pin Threaded M12/Euro-Style Cordsets—Single Ended | | | | |
|---|----------------|-------------|---|---|
| Model | Length | Style | Dimensions | Pinout (Female) |
| MQDC-406 | 1.83 m (6 ft) | Straight |  |  1 = Brown 2 = White 3 = Blue 4 = Black |
| MQDC-415 | 4.57 m (15 ft) | | | |
| MQDC-430 | 9.14 m (30 ft) | | | |
| MQDC-450 | 15.2 m (50 ft) | Right-Angle | | |
| MQDC-406RA | 1.83 m (6 ft) | | | |
| MQDC-415RA | 4.57 m (15 ft) | | | |
| MQDC-430RA | 9.14 m (30 ft) | | | |
| MQDC-450RA | 15.2 m (50 ft) | | | |

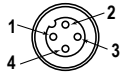
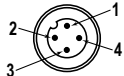
| 4-Pin Threaded M12/Euro-Style Cordsets—Double Ended | | | | |
|---|----------------|-------------------------------|------------|---|
| Model | Length | Style | Dimensions | Pinout |
| MQDEC-401SS | 0.31 m (1 ft) | Male Straight/Female Straight | | Female |
| MQDEC-403SS | 0.91 m (3 ft) | | |  |
| MQDEC-406SS | 1.83 m (6 ft) | | | Male |
| MQDEC-412SS | 3.66 m (12 ft) | | |  |
| MQDEC-420SS | 6.10 m (20 ft) | | | |
| MQDEC-430SS | 9.14 m (30 ft) | | | |
| MQDEC-450SS | 15.2 m (50 ft) | | | 1 = Brown 2 = White 3 = Blue 4 = Black |

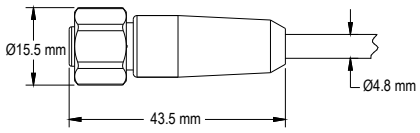
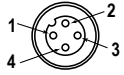
| 4-Pin Threaded M12/Euro-Style Cordsets—Washdown, Stainless Steel, Single Ended | | | | |
|--|----------------|----------|--|---|
| Model | Length | Style | Dimensions | Pinout (Female) |
| MQDC-WDSS-0406 | 1.83 m (6 ft) | Straight |  |  <p>1 = Brown 2 = White 3 = Blue 4 = Black</p> |
| MQDC-WDSS-0415 | 4.57 m (15 ft) | | | |
| MQDC-WDSS-0430 | 9.14 m (30 ft) | | | |

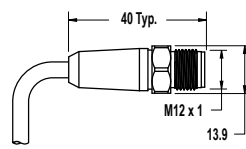
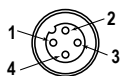
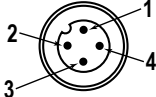
| 4-Pin Threaded M12/Euro-Style Cordsets—Double Ended, Washdown, Stainless Steel | | | | |
|--|----------------|-------------------------------|--|---|
| Model | Length | Style | Dimensions | Pinout |
| MQDEC-WDSS-401SS | 0.3 m (1 ft) | Male Straight/Female Straight |  | Female |
| MQDEC-WDSS-403SS | 0.91 m (3 ft) | | |  |
| MQDEC-WDSS-406SS | 1.83 m (6 ft) | | | Male |
| MQDEC-WDSS-412SS | 3.66 m (12 ft) | | |  <p>1 = Brown 2 = White 3 = Blue 4 = Black</p> |

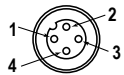
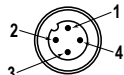
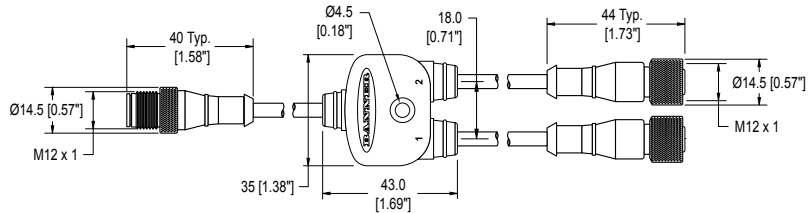
| 4-Pin Threaded M12/Euro-Style Splitter Cordsets—Flat Junction | | | | |
|--|-------------------|---------------------------|---|---|
| Model | Branches (Female) | Trunk (Male) | Pinout | |
| CSB-M1240M1240 | No branch | No trunk |  |  <p>1 = Brown 2 = White 3 = Blue 4 = Black</p> |
| CSB-M1240M1241 | 2 x 0.30 m (1 ft) | No trunk | | |
| CSB-M1241M1241 | | 0.30 m (1 ft) | | |
| CSB-M1248M1241 | | 2.50 m (8 ft) | | |
| CSB-M12415M1241 | | 4.57 m (15 ft) | | |
| CSB-M12425M1241 | | 7.60 m (25 ft) | | |
| CSB-UNT425M1241 | | 7.60 m (25 ft) Untermated | | |
|  | | | | |

Brackets

LMBWLS27EC

- Clear copolyester
- Clearance for M5 or #10 hardware

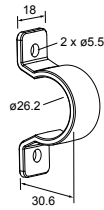

LMBWLS27H

- 300 series stainless steel mounting brackets
- M4 stainless steel hardware included

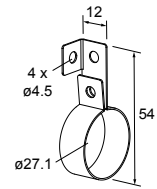

LMBWLS27SP

- Clear copolyester
- Clearance for M5 or #10 hardware
- Snap bracket for light duty applications

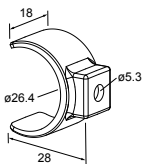

LMBWLS27T

- Stainless steel mounting brackets with rubber grips
- M5 stainless steel hardware included
- Clearance for M5 or #10 hardware

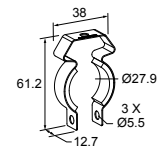

LMBWLS27U

- Clear copolyester
- Clearance for M5 or #10 hardware
- Clamps securely around the light body

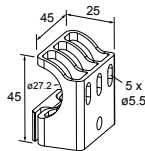

Banner Engineering Corp. Limited Warranty

Banner Engineering Corp. warrants its products to be free from defects in material and workmanship for one year following the date of shipment. Banner Engineering Corp. will repair or replace, free of charge, any product of its manufacture which, at the time it is returned to the factory, is found to have been defective during the warranty period. This warranty does not cover damage or liability for misuse, abuse, or the improper application or installation of the Banner product.

THIS LIMITED WARRANTY IS EXCLUSIVE AND IN LIEU OF ALL OTHER WARRANTIES WHETHER EXPRESS OR IMPLIED (INCLUDING, WITHOUT LIMITATION, ANY WARRANTY OF MERCHANTABILITY OR FITNESS FOR A PARTICULAR PURPOSE), AND WHETHER ARISING UNDER COURSE OF PERFORMANCE, COURSE OF DEALING OR TRADE USAGE.

This Warranty is exclusive and limited to repair or, at the discretion of Banner Engineering Corp., replacement. **IN NO EVENT SHALL BANNER ENGINEERING CORP. BE LIABLE TO BUYER OR ANY OTHER PERSON OR ENTITY FOR ANY EXTRA COSTS, EXPENSES, LOSSES, LOSS OF PROFITS, OR ANY INCIDENTAL, CONSEQUENTIAL OR SPECIAL DAMAGES RESULTING FROM ANY PRODUCT DEFECT OR FROM THE USE OR INABILITY TO USE THE PRODUCT, WHETHER ARISING IN CONTRACT OR WARRANTY, STATUTE, TORT, STRICT LIABILITY, NEGLIGENCE, OR OTHERWISE.**

Banner Engineering Corp. reserves the right to change, modify or improve the design of the product without assuming any obligations or liabilities relating to any product previously manufactured by Banner Engineering Corp. Any misuse, abuse, or improper application or installation of this product or use of the product for personal protection applications when the product is identified as not intended for such purposes will void the product warranty. Any modifications to this product without prior express approval by Banner Engineering Corp will void the product warranties. All specifications published in this document are subject to change; Banner reserves the right to modify product specifications or update documentation at any time. Specifications and product information in English supersede that which is provided in any other language. For the most recent version of any documentation, refer to: www.bannerengineering.com.

For patent information, see www.bannerengineering.com/patents.

FCC Part 15 and CAN ICES-3 (B)/NMB-3(B)

This device complies with part 15 of the FCC Rules and CAN ICES-3 (B)/NMB-3(B). Operation is subject to the following two conditions:

1. This device may not cause harmful interference, and
2. This device must accept any interference received, including interference that may cause undesired operation.

This equipment has been tested and found to comply with the limits for a Class B digital device, pursuant to part 15 of the FCC Rules and CAN ICES-3 (B)/NMB-3(B). These limits are designed to provide reasonable protection against harmful interference in a residential installation. This equipment generates, uses and can radiate radio frequency energy and, if not installed and used in accordance with the instructions, may cause harmful interference to radio communications. However, there is no guarantee that interference will not occur in a particular installation. If this equipment does cause harmful interference to radio or television reception, which can be determined by turning the equipment off and on, the user is encouraged to try to correct the interference by one or more of the following measures:

- Reorient or relocate the receiving antenna.
- Increase the separation between the equipment and receiver.
- Connect the equipment into an outlet on a circuit different from that to which the receiver is connected.
- Consult the manufacturer.

Mexican Importer

Banner Engineering de México, S. de R.L. de C.V.
David Alfaro Siqueiros 103 Piso 2 Valle oriente
San Pedro Garza García Nuevo León, C. P. 66269
81 8363.2714