

# Photoelectrics Through-beam, Transistor Output Type PA12BNT20..

CARLO GAVAZZI



- Elevators, Escalators and Entrance control
- Range 20 m
- ESPE-Type 2, PL C.
- Modulated, infrared light
- Supply voltage: 10 to 30 VDC
- Output: 100 mA, NPN or PNP type
- Make or break switching
- Protection: reverse polarity, short circuit, transients
- Cable versions with or without connector
- Emitter mute and power adjustment
- CE, UL325 and UL508 approved



## Product Description

The PA12BNT. is a through beam sensor set specially designed for elevators, escalators, entrance control to meet the requirements in the door market. The housing is very robust and is

known for its high long-term reliability. The emitter has a mute input to turn it off for evaluation of the sensor function. Available in 10-30 VDC version.

## Ordering Key

**PA12BNT20NO-C2**

Type	_____
Housing style	_____
Housing size	_____
Housing material	_____
Neutral	_____
Detection principle	_____
Sensing distance	_____
Output type	_____
Output configuration	_____
Connection type	_____
Cable connector	_____

## Type Selection

Housing diameter	Range S <sub>n</sub>	Connector	Ordering no. Receiver NPN, NO	Ordering no. Receiver NPN, NC	Ordering no. Receiver PNP, NO	Ordering no. Receiver PNP, NC	Ordering no. Emitter
M12	20 m	NO	PA12BNT20NO	PA12BNT20NC	PA12BNT20PO	PA12BNT20PC	PA12BNT20
M12	20 m	YES	PA12BNT20NO-C2	PA12BNT20NC-C2	PA12BNT20PO-C2	PA12BNT20PC-C2	PA12BNT20-C2

Note: Please order emitter and receiver separately

## Specifications Emitter

Rated operational volt. (U <sub>B</sub> )	10 to 30 VDC	Light source	LED, 860 nm
Ripple (U <sub>rrp</sub> )	≤ 10%	Light type	Infrared, modulated
Supply current	≤ 20 mA	Light spot	1580 mm @ 12 m
Protection	Reverse polarity, transients	Emitter angle	± 3.8° @ 12 m
Power ON delay (t <sub>v</sub> )	≤ 100 ms	Power adjustment	R <sub>x</sub> ~ 3 kΩ -10 kΩ
Control input			4...24 m in 19 steps
Normal oper.	> 1.5 VDC		
Mute	< 1.2 VDC		

## Specifications Receiver

<b>Rated operating dist. (S<sub>n</sub>)</b>	20 m
<b>Blind zone</b>	None
<b>Temperature drift</b>	≤ 0.4%/°C
<b>Hysteresis (H)</b>	3 - 20%
<b>Rated operational volt. (U<sub>B</sub>)</b>	10 to 30 VDC (ripple included)
<b>Ripple (U<sub>rrp</sub>)</b>	≤ 10%
<b>No load supply current (I<sub>o</sub>)</b>	≤ 16 mA
<b>Output current</b> Continuous (I <sub>a</sub> ) Short-time (I)	≤ 100 mA ≤ 100 mA, (max. load capacity 100 nF)
<b>Minimum operational current (I<sub>m</sub>)</b>	0.5 mA
<b>OFF-state current (I<sub>r</sub>)</b>	≤ 100 μA
<b>Voltage drop (U<sub>d</sub>)</b>	≤ 1.6 VDC @ 100 mA

<b>Protection</b>	Short-circuit, reverse polarity, transients
<b>Utility category</b>	DC12 DC13 Control of resistive loads and solid state loads with optical insulation Control of electromagnets
<b>Ambient light</b>	> 20.000 Lux (EN60947-5-2)
<b>Detection angle</b>	± 2.9° @ 12 m
<b>Operating frequency (f)</b>	100 Hz
<b>Response time</b>	OFF-ON (t <sub>ON</sub> ) ≈ 6.5 ms ON-OFF (t <sub>OFF</sub> ) ≈ 3.5 ms
<b>Power ON delay (t<sub>v</sub>)</b>	≤ 100 ms
<b>Output function</b> NPN or PNP	Make or break (NO or NC)

## General Specifications

<b>Environment</b>	
Overvoltage category	III (IEC 60664/60664A, 60947-1)
Pollution degree	3 (IEC 60664/60664A, 60947-1)
Degree of protection	IP67 (IEC 60529; EN60947-1) 1, 2, 3, 4, 6, 12, 13 (NEMA types)
<b>Temperature</b>	
Operating	-20° to +50°C (-4° to +122°F)
Storage	-25° to +80°C (-13° to +176°F)
<b>Rated insulation voltage</b>	75 VDC
<b>Dielectric test voltage</b>	500 Vac rms (EN60947-1)
<b>Rated impulse withstand test</b>	800 V (1.2 / 50 μs) (EN60947-1)
<b>ESPE</b>	Type 2
<b>PFH<sub>d</sub></b>	6 x 10 <sup>-8</sup> failure per hour (worst case SRP for CS)
<b>Diagnostic coverage</b>	99 % (EN13849-1: 2008)
<b>Performance level</b>	C (EN13849-1: 2008)
<b>MTTF<sub>d</sub></b> (worst case full sensor)	345 Years (worst case full receiver) EN ISO 13849-1, SN 29500 412 Years (worst case full emitter) EN ISO 13849-1, SN 29500
<b>Electrostatic discharge</b> (EN61000-4-2)	
Contact discharge	> 12 kV
Air discharge	> 8 kV
<b>Radiated RF electromagnetic fields</b> (EN 61000-4-3)	> 10 V/m

<b>Electrical fast transients/burst</b> (EN 61000-4-4)	± 4 kV
<b>Surge</b> (EN 61000-4-5)	
Power-supply	> 1 kV (with 500 Ω)
Sensor output	> 1 kV (with 500 Ω)
<b>Wire conducted disturbances</b> (EN 61000-4-6)	> 10 Vrms
<b>Power-frequency magnetic fields</b> (EN 61000-4-8)	
Continuous	> 30 A/m, 38 μ tesla
Short-time	> 300 A/m, 380 μ tesla
<b>Vibration</b> (IEC 60068-2-6)	10 to 150 Hz, 1 mm / 15 g
<b>Shock</b> (IEC 60068-2-27)	30 G / 11 ms, 6 pos, 6 neg per axis
<b>Free fall</b> (IEC 60068-2-31)	2 times from 1 m 100 times from 0.5 m
<b>Pig-tail connector (-C2)</b>	3-pol micro MATE-N-LOK Series, AMP/TE
<b>Housing material</b>	
Body	M12-Stainless Steel
Front	PC black
<b>Connection</b>	
Cable	PVC, Emitter: grey / Receiver: black, 5 m, 3 x 0.14 mm <sup>2</sup> , Ø 2.9 mm
<b>Weight</b>	
Emitter	80 g
Receiver	80 g
<b>CE-marking</b>	EN12445, EN12453, EN12978, EN 60947-5-2
<b>UL-Approval</b>	UL325 UL508, CSA-C22.2 No.247

## Operation Diagram

tv = Power ON delay

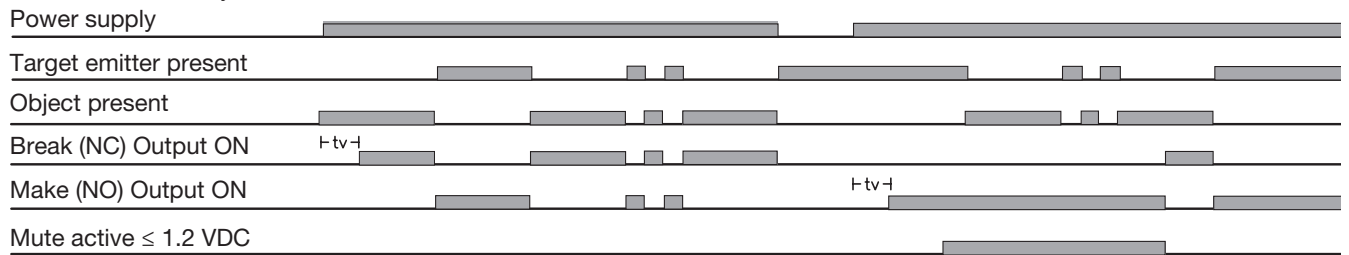

## Dimensions

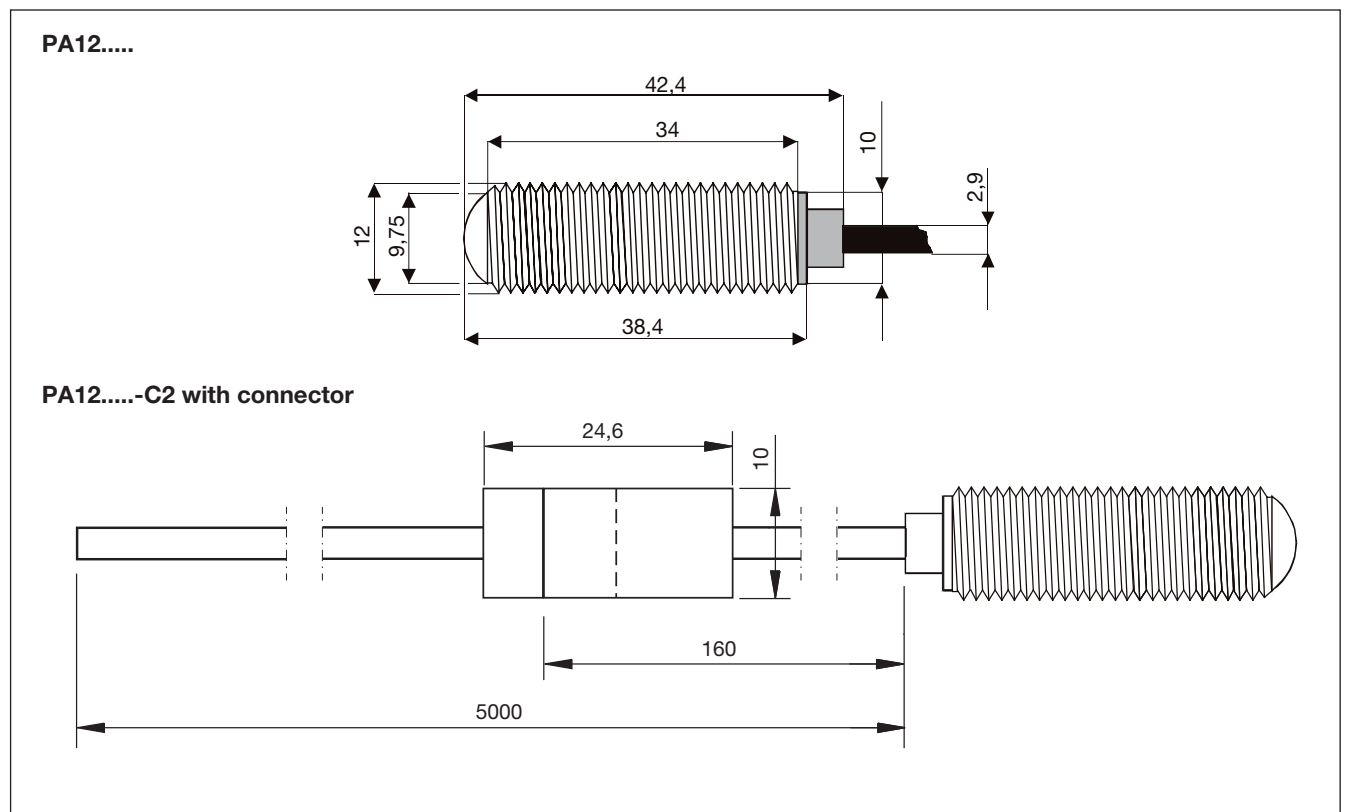

## Wiring Diagram

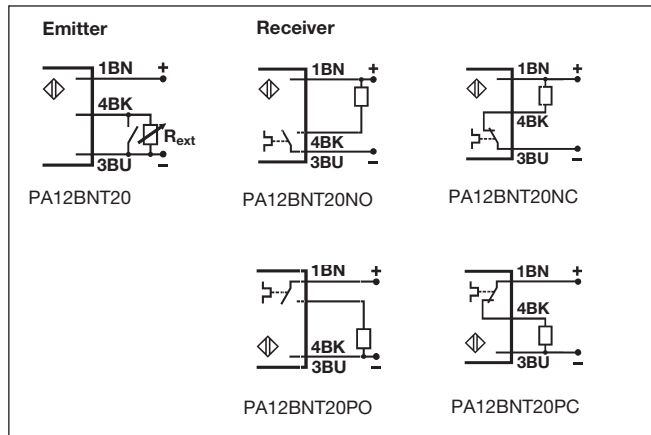

## Detection Diagram

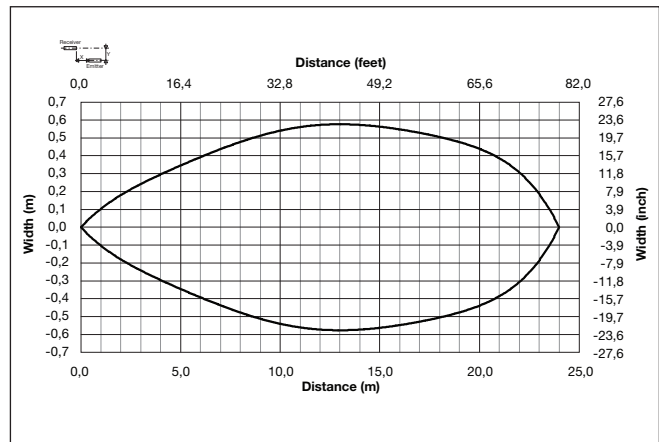

## Power adjustment curve

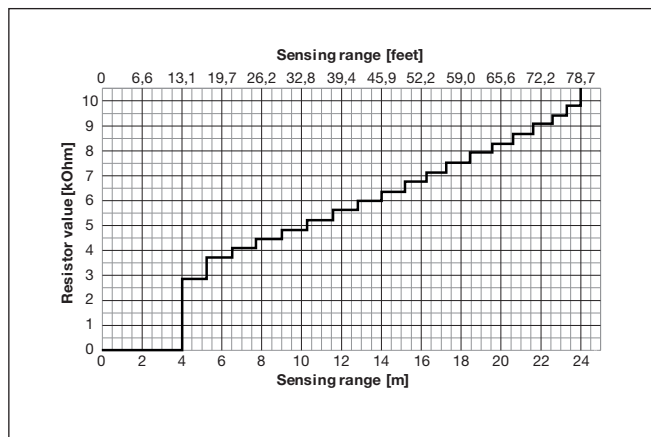

## Excess Gain

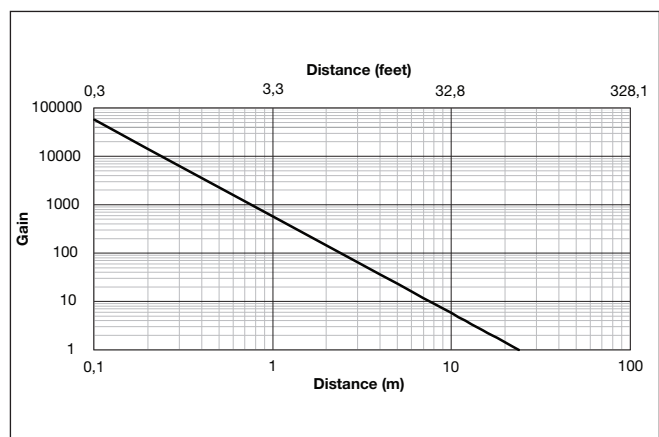

## Installation Hints

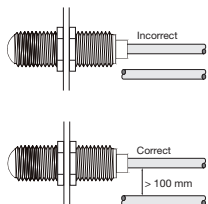
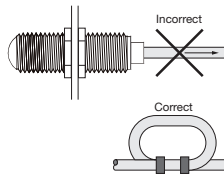
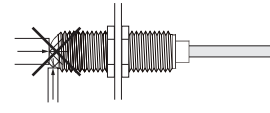
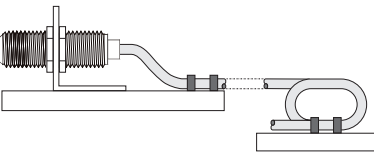
<p>To avoid interference from inductive voltage/current peaks, separate the prox. switch power cables from any other power cables, e.g. motor, contactor or solenoid cables</p> 	<p>Relief of cable strain</p>  <p>The cable should not be pulled</p>	<p>Protection of the sensing face</p>  <p>A proximity switch should not serve as mechanical stop</p>	<p>Switch mounted on mobile carrier</p>  <p>Any repetitive flexing of the cable should be avoided</p>
---	---	---	--

## Delivery Contents

- PA12
- Packaging: plastic bag