

Proximity Sensors Capacitive Thermoplastic Polyester Types CA30CLN12Mxxxx

CARLO GAVAZZI

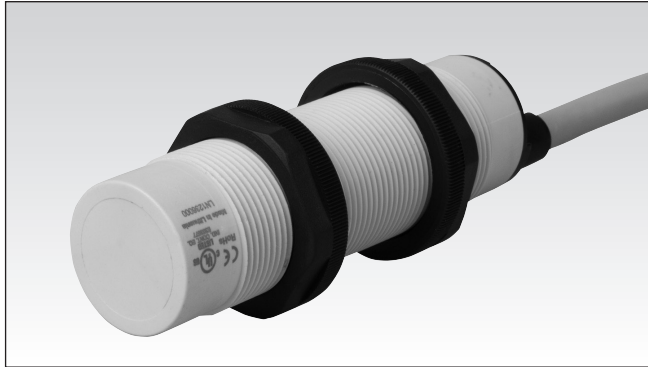

- Level sensor for solid, fluid or granulated substances
- Adjustable sensing distance: 4-12 mm
- Multi voltage supply: 20.4 to 255 VAC/DC
- SPDT relay output
- Time delay on operate or release
- Time delay options up to 10 minutes
- CA30..MU/CA30..MV: With adjustable time delay
- CA30CLN12MT: Without time delay
- Cable versions

Product Description

Capacitive sensor in M30 thermoplastic polyester housing for mounting with 2 nuts. Available with adjustable sensing distance and with/without built-in time

delay (ON or OFF delay). The relay output ensures that the load can be driven directly. Excellent for use in the agricultural sector (detection of grains, fluids etc.).

Ordering Key CA30CLN12MU10M

Type _____
 Time delay options _____
 Voltage _____
 Time delay _____

Type Selection

Supply voltage	Ordering no. With ON delay	Ordering no. With OFF delay	Ordering no. Without time delay
24- 230 V AC/DC	CA30CLN12MU10M	CA30CLN12MV10M	CA30CLN12MT

Specifications

Rated operating distance (S_n)	Up to 12 mm, reference target 30 x 30 mm ST37.1 mm thick, grounded	Response time	OFF-ON (t _{ON}) ON-OFF (t _{OFF})	≤ 500 ms ≤ 500 ms
Sensing distance	4-12 mm, adjustable Factory set at 7 mm	Power ON delay (t_v)		≤ 200 ms
Sensing distance adjustment	Multiturn, 15 turns adjustment steps	Output function		SPDT relay
Temperature drift	0.8 x Sr ≤ Su ≤ 1.2 x Sr	Output switching function		N.O. and N.C.
Hysteresis (H)	3 to 20%	Indication	Output ON Time Delay	Yellow LED LED flashing depend on time delay
Rated operational volt. (U_B)	20.4 to 255 VAC/DC (ripple included)	Output Time delay	Delay on operate, adjustment CA30CLN12MU10M Delay on release, adjustment CA30CLN12MV10M No time delay CA30CLN12MT	Factory settings 0 sec. 1 sec. - 10 min. 1 sec. - 10 min. no delay
Rated supply frequency	47 to 63 Hz	Time delay adjustment		Multiturn, 15 turns
Rated operational power	0.5 to 2.5 VA	Environment	Installation category Pollution degree Degree of protection	III (IEC 60664/60664A; 60947-1) 3 (IEC 60664/60664A; 60947-1) IP 67, (IEC 60529; 60947-1) NEMA 1, 2, 4, 4X, 5, 6, 6P, 12
Output	2 A Relay SPDT@240 VAC AC12 2 A AC140 2 A DC12 2 A DC13 2 A			
Mechanical life typically Electrical lifetime	15x10 ⁶ operations 1x10 ⁵ operations @ 2A/240VAC			
Minimum operational current (I_m)	10 mA@12 VDC (i.e. Minimum relay current)			
Protection	Reverse polarity and transients			
Operating frequency (f)	≤ 1 Hz			

Specifications (cont.)

Ambient temperature Operating temperature	-20° to +70°C (-4° to +158°F)	Housing material Body Backpart Trimmer	PBTP Arnite LCP Vectra
Storage temperature	-40° to +85°C (-40° to +185°F)	Connection Cable	PVC, grey, 2 m 5 x 0.75 mm ² , Ø = 7.5 mm
Vibration	10 to 150 Hz, 1.0 mm/15 G (IEC 60068-2-6)	Weight	≤ 320 g
Shock	30 g / 11ms, 3 pos, 3 neg per axis (IEC 60068-2-6, 60068-2-32)	Approvals UL (overvoltage category II)	cULus (UL508+CSA)
Rated insulation voltage	≥ 250 VAC (rms)	CE-marking	Yes

Dimensions

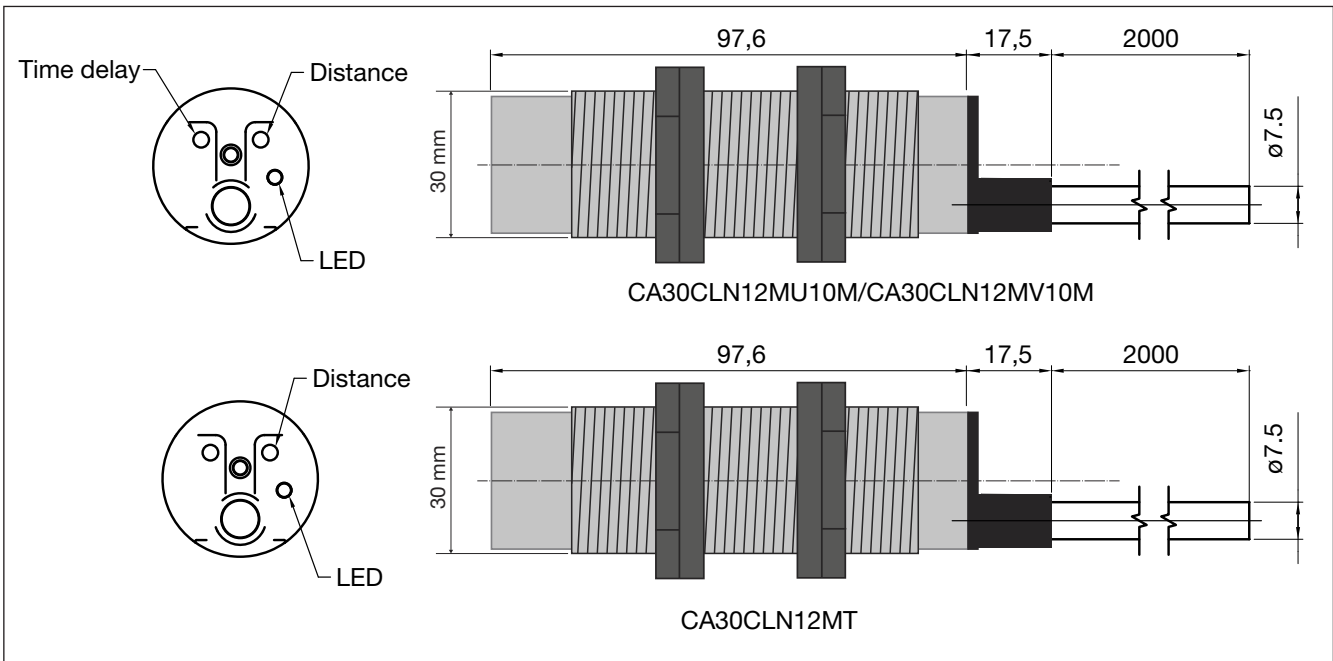

Trimmer VS Delaytime

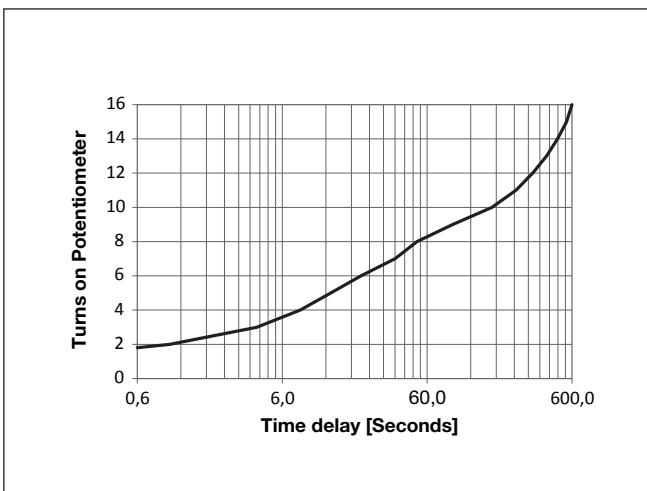

Trimmer VS Distance

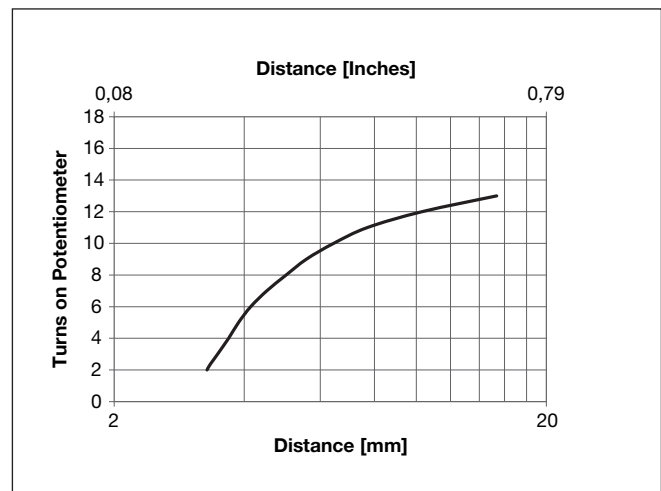

Detection Diagram

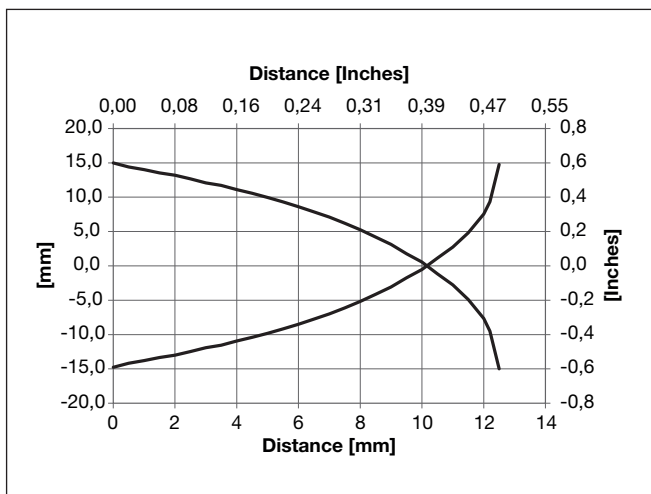

Wiring Diagram

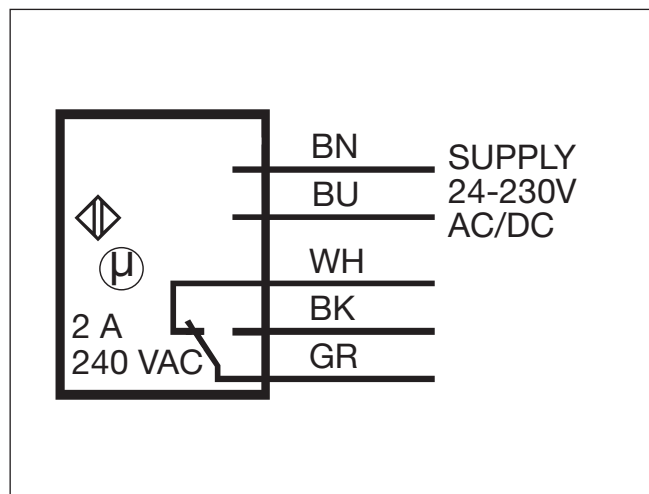

Mode of Operation

CA30CLN12MU10M (See operation diagram). Power supply is applied to the sensor (BN and BU wires). When the target is not present, the relay operates (connection between GR and BK wires) and LED lights. When the target is detect-

ed the time measurement starts and LED flashes. After expiration of the set time (0-10 min.), the relay releases (connection between GR and WH wires) and LED turns off. The relay remains released as long as the target is detected.

CA30CLN12MV10M (See operation diagram). Power supply is applied to the sensor BN and BU wires) and time measurement starts. When the set time has expired (0-10 min.) the relay operates (connection between GR and BK wires)

and remains connected until the target is detected. After activation of the sensor the relay releases (connection between GR and WH wires). As soon as the target is not present again the time measurements of the set time starts.

CA30CLN12MT (See operation diagram). Power supply is applied to the sensor (BN and BU wires). The relay operates (connection between GR and BK wires)

and remains ON until the target is detected. After activation of the sensor the relay releases (connection between GR and WH wires.)

Adjustment

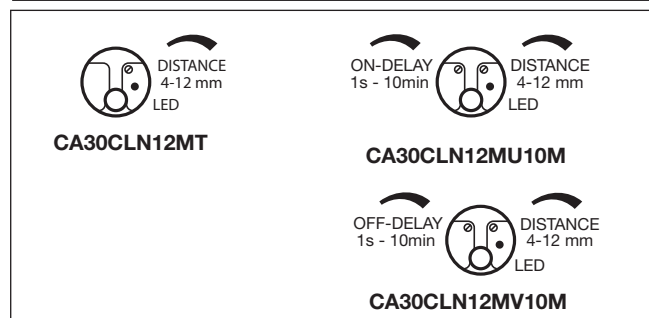

Operation Diagrams

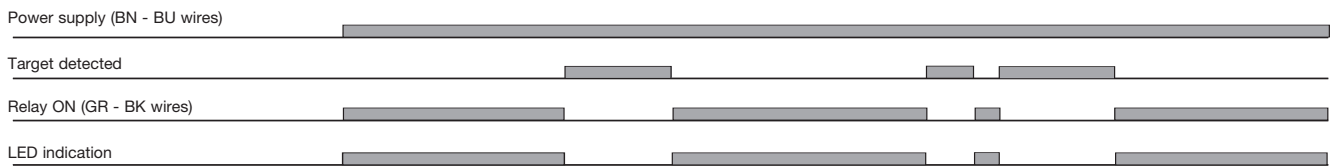

CA30CLN12MT

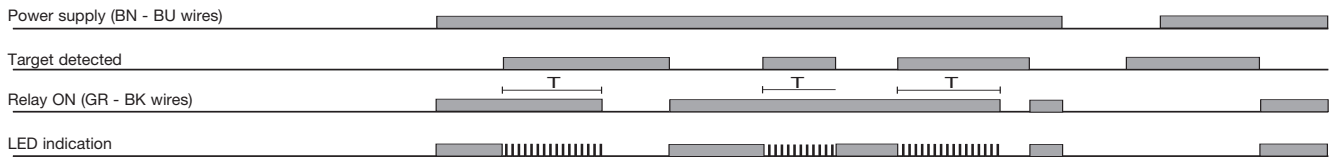

CA30CLN12MU10M

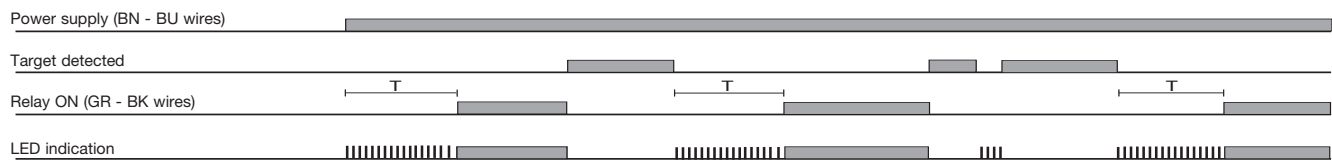

CA30CLN12MV10M

Installation Hint

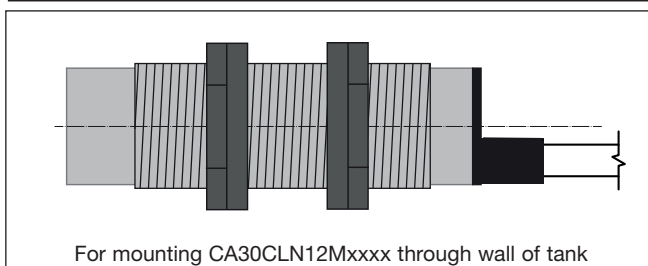

Delivery Contents

- Capacitive switch: CA30CLN12Mxxxx
- Installation instruction
- 2 x M30 Nuts
- Screwdriver
- Packaging: Plastic bag