

# Protistor<sup>®</sup> sizes 2x122 and 2x123 gR

750VDC (IEC)

## SEMICONDUCTOR PROTECTION FUSES

## SQUARE BODY HIGH-SPEED FUSE-LINKS DC PROTECTION



Mersen DC offers provide a very high performant protection for railway power and auxiliary circuits. Mersen DC Semiconductor fuse-links were developed to provide improved performance required by today's new DC equipment. These fuse-links are typically operated at more elevated temperature than other fuse type, have lower  $I^2t$  to minimize damage to protected components on short circuits, lower watts loss and longer life.

### TECHNICAL DATA OVERVIEW

Ampere Range (A)	500 ... 1600 A
Speed/Characteristic	gR
I.R. AC (IEC)	100 kA
Rated Voltage DC (IEC)	750 VDC

### FEATURES & BENEFITS

- Multiple body sizes and terminals or blades combination
- Very low  $I^2t$
- Extremely fast acting
- Eliminate all overloads
- Excellent cycling capability

### APPLICATIONS

- Protection of inverters
- Protection of motor drives
- Protection of UPS systems
- Railway power and auxiliary circuits
- Similar 750VDC or less equipments



MERSEN reserves the right to change, update or correct, without notice, any information contained in this datasheet.

# Protistor® sizes 2x122 and 2x123 gR 750VDC (IEC)

## PRODUCT RANGE



D2122GC75V500TF

### Size 2x122 gR 750VDC

Catalog number	Item number	Rated voltage DC (IEC)	Rated current I <sub>n</sub>	Rated breaking capacity DC	Power dissipation at I <sub>n</sub>	Weight
D2122GC75V500TF	Q090473	750 V	500 A	100 kA	94 W	2.8 kg
D2122GC75V630TF	R090474	750 V	630 A	100 kA	116 W	2.8 kg
D2122GC75V800TF	S090475	750 V	800 A	100 kA	149 W	2.8 kg
D2122GD75V900TF	T220955	750 V	900 A	100 kA	180 W	2.8 kg
D2122GD75V10CTB	V220956	750 V	1000 A	100 kA	190 W	2.8 kg

### Size 2x123 gR 600 to 750VDC

Catalog number	Item number	Rated voltage DC (IEC)	Rated current I <sub>n</sub>	Rated breaking capacity DC	Power dissipation at I <sub>n</sub>	Weight
D2123GC75V10CTF	Z090481	750 V	1000 A	100 kA	187 W	4.26 kg
D2123GB75V12CTF	D098558	750 V	1250 A	100 kA	-	4.26 kg
D2123GB75V14CTF	B090483	750 V	1400 A	100 kA	-	4.26 kg
D2123GD75V15CTF	K220947	750 V	1500 A	100 kA	-	4.26 kg
D2123GB66V16CTF	L220948	660 V	1600 A	100 kA	-	4.26 kg

MERSEN reserves the right to change, update or correct, without notice, any information contained in this datasheet.

# Protistor® sizes 2x122 and 2x123 gR

750VDC (IEC)

## TIME CURRENT CHARACTERISTIC CURVES

### Size 2x122 gR 500A-800A

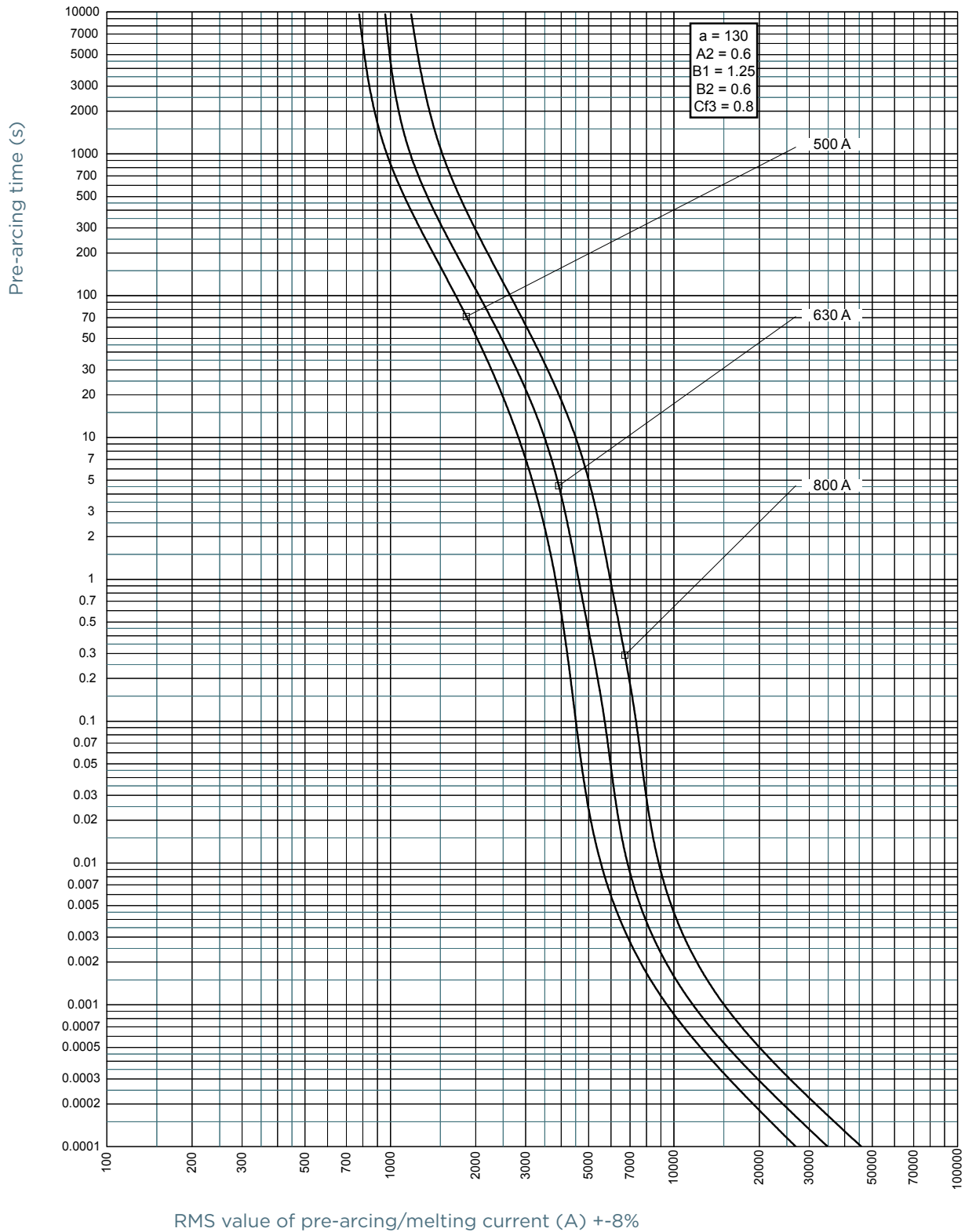

MERSEN reserves the right to change, update or correct, without notice, any information contained in this datasheet.

# Protistor® sizes 2x122 and 2x123 gR

750VDC (IEC)

## TIME CURRENT CHARACTERISTIC CURVES

### Size 2x122 gR 900A-1000A

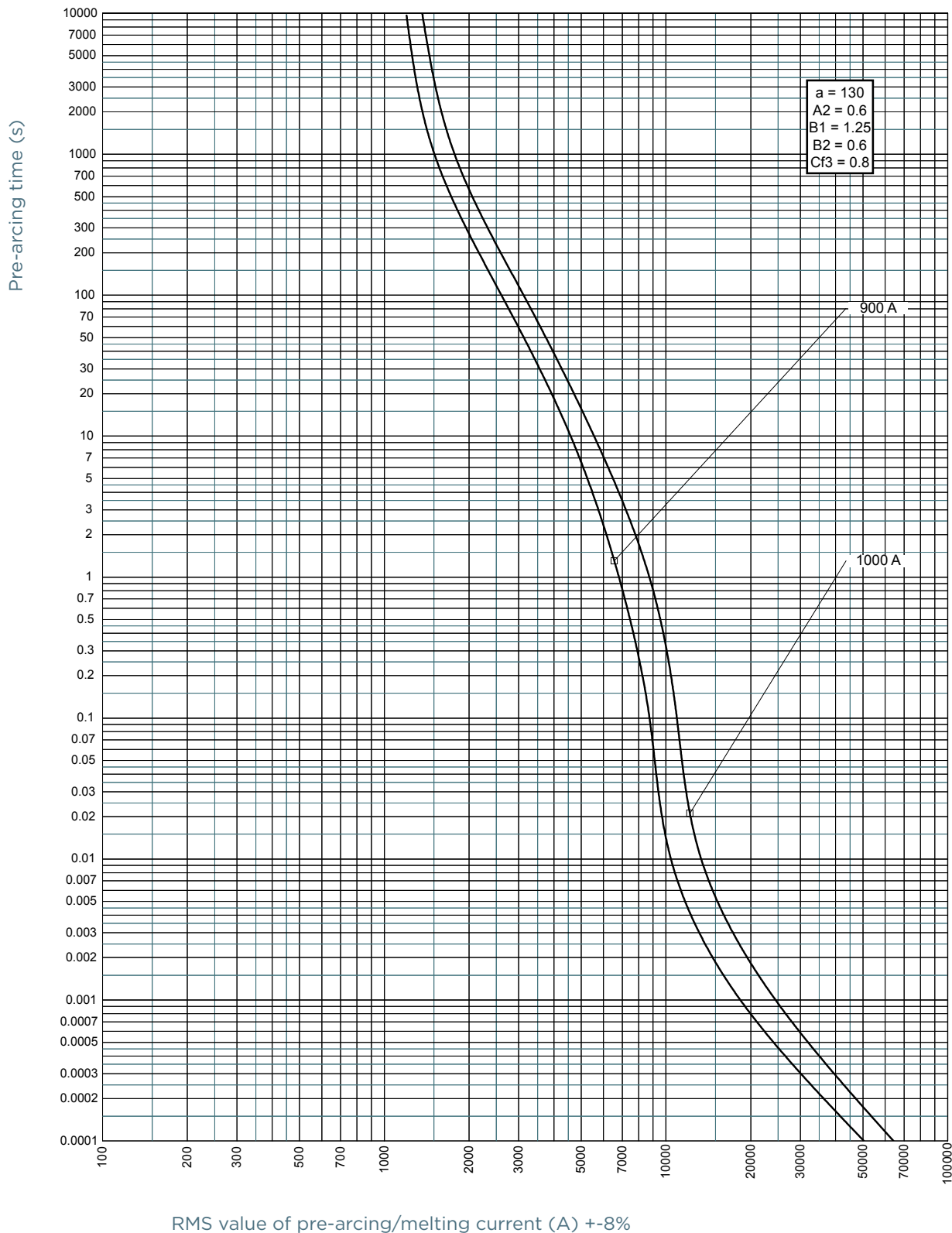

MERSEN reserves the right to change, update or correct, without notice, any information contained in this datasheet.

## TIME CURRENT CHARACTERISTIC CURVES

### Size 2x123 gR 1000A

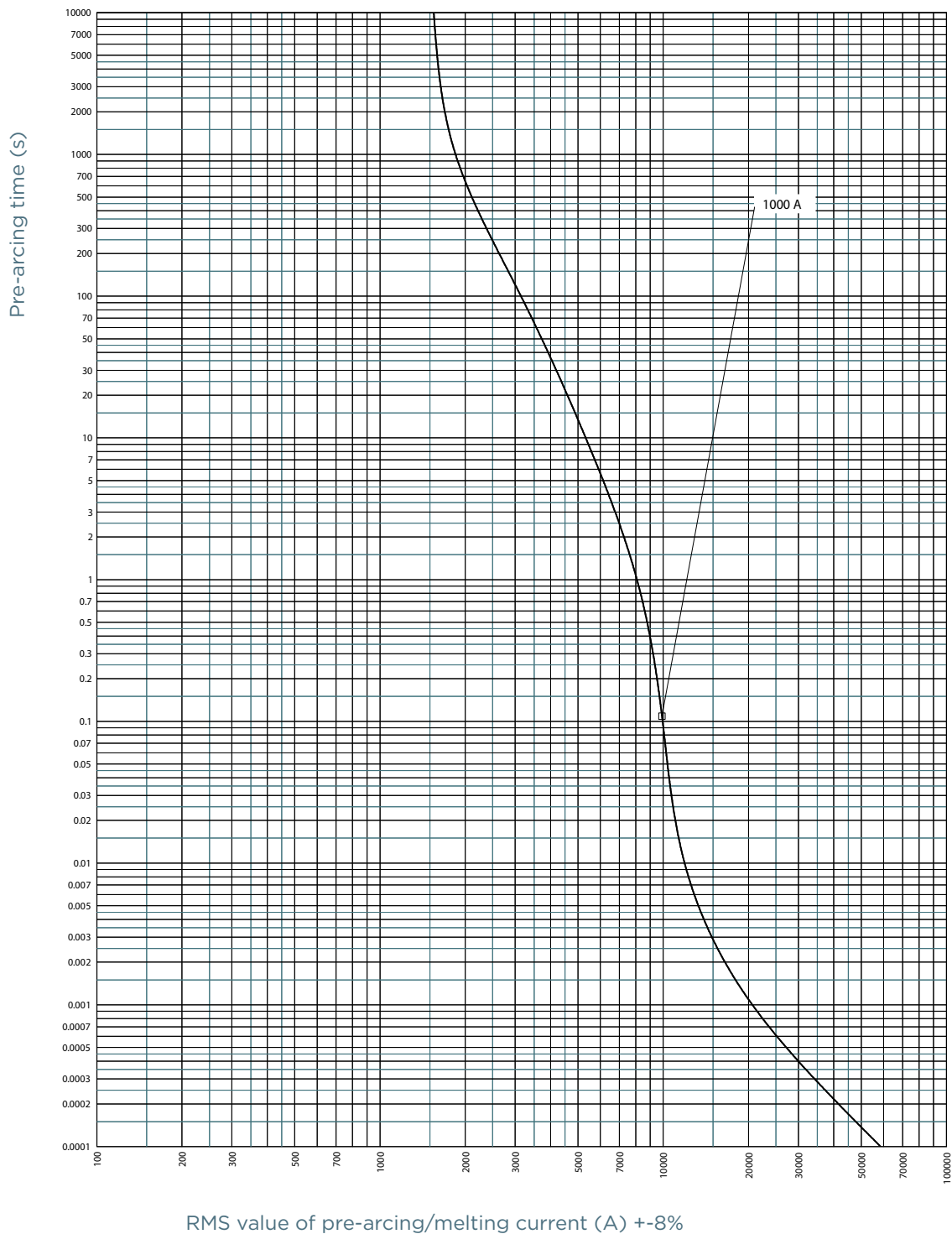

## TIME CURRENT CHARACTERISTIC CURVES

### Size 2x123 gR 1250-1400A

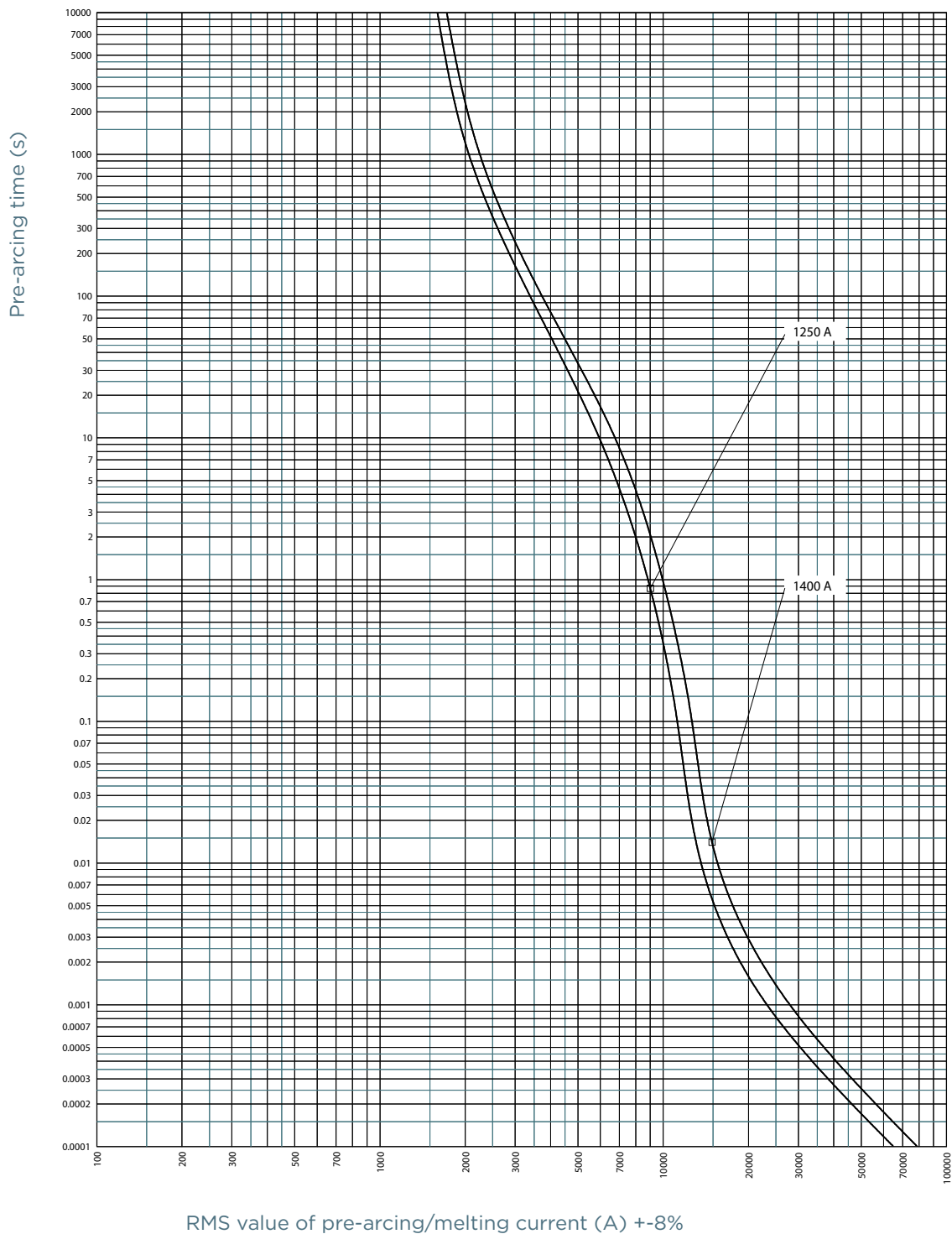

## TIME CURRENT CHARACTERISTIC CURVES

### Size 2x123 gR 1500A

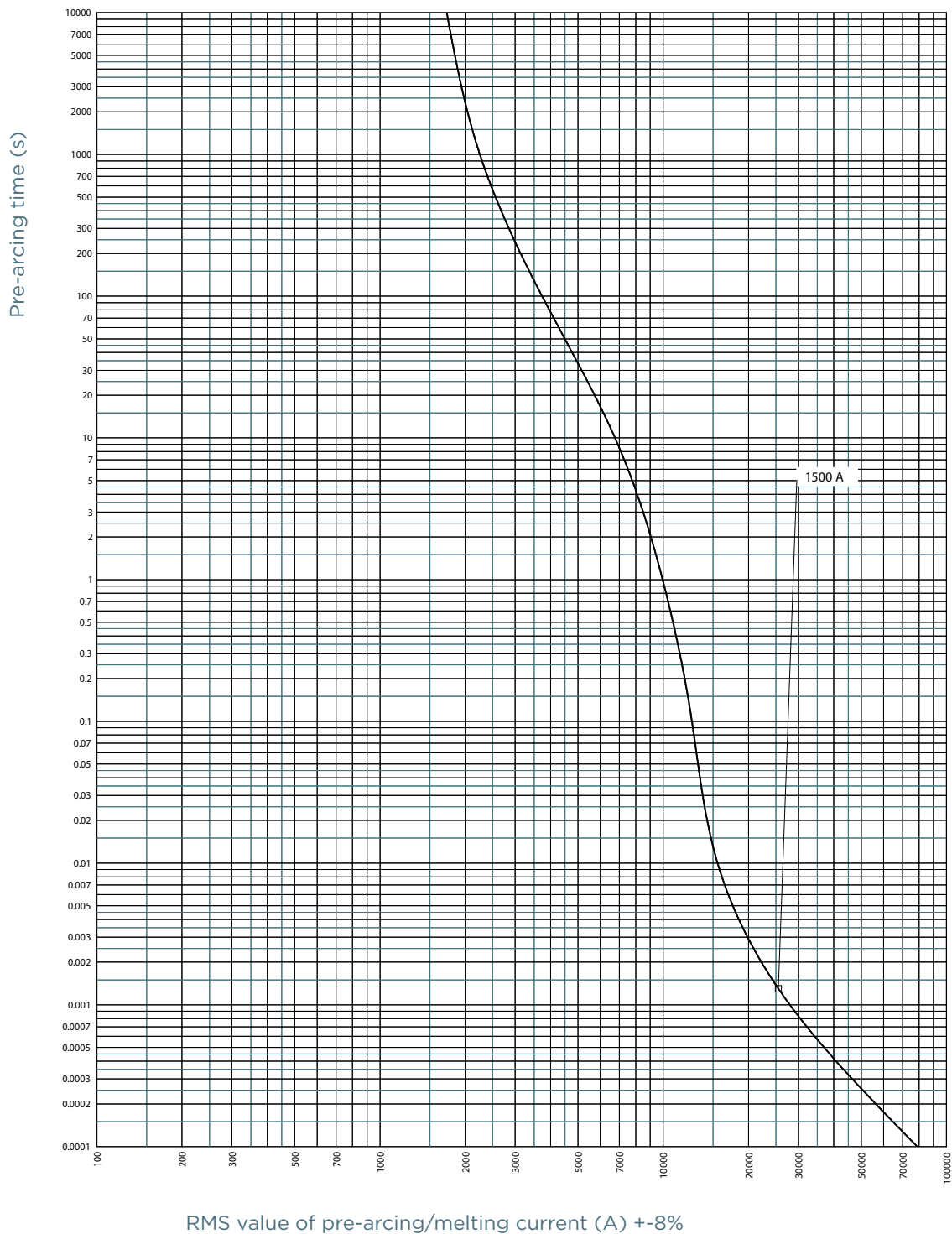

## TIME CURRENT CHARACTERISTIC CURVES

### Size 2x123 gR 1600A

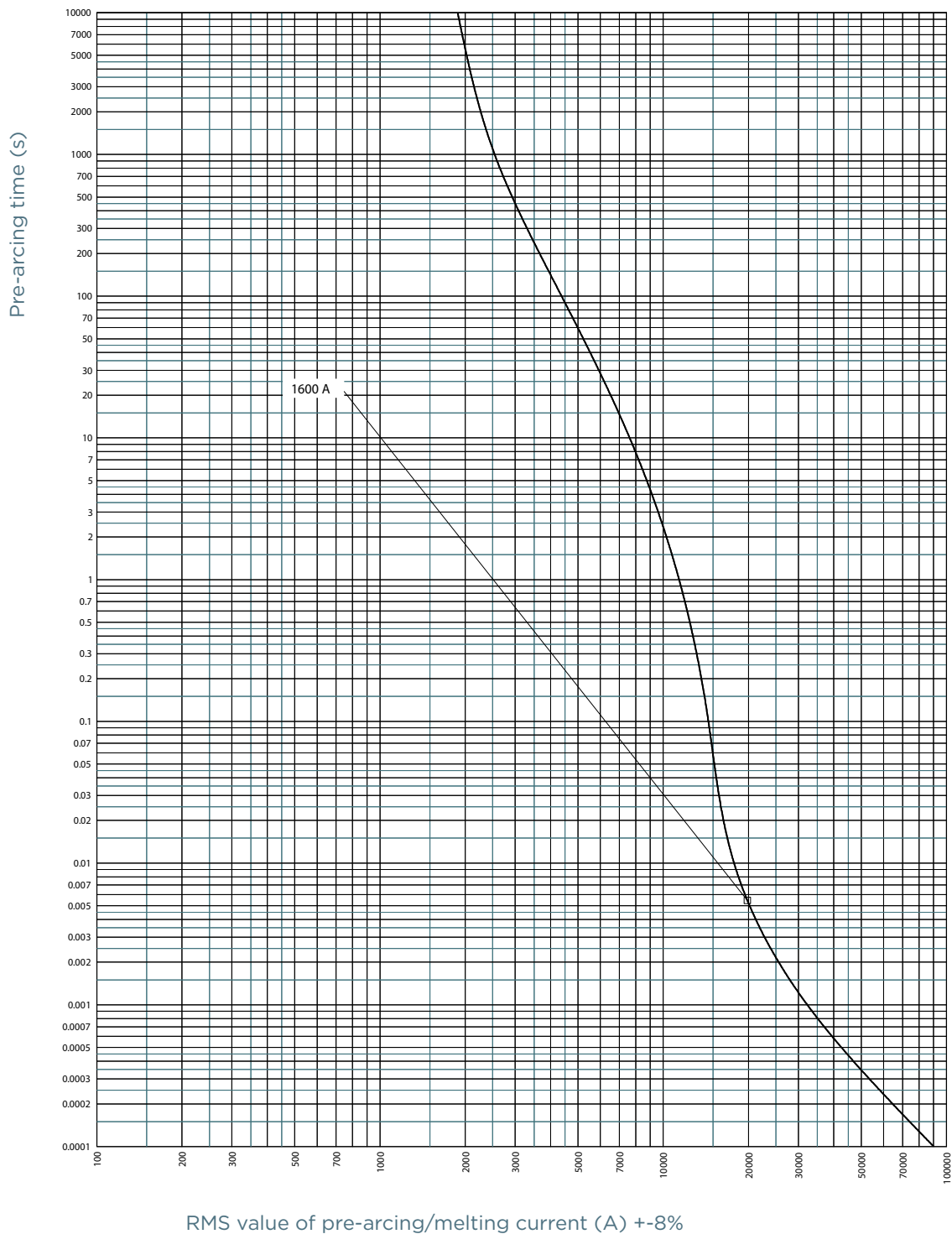



# Protistor® sizes 2x122 and 2x123 gR

750VDC (IEC)

## L/R TIME CONSTANT VS DC VOLTAGE CAPABILITY

### Size 2x122 gR 500A-800A

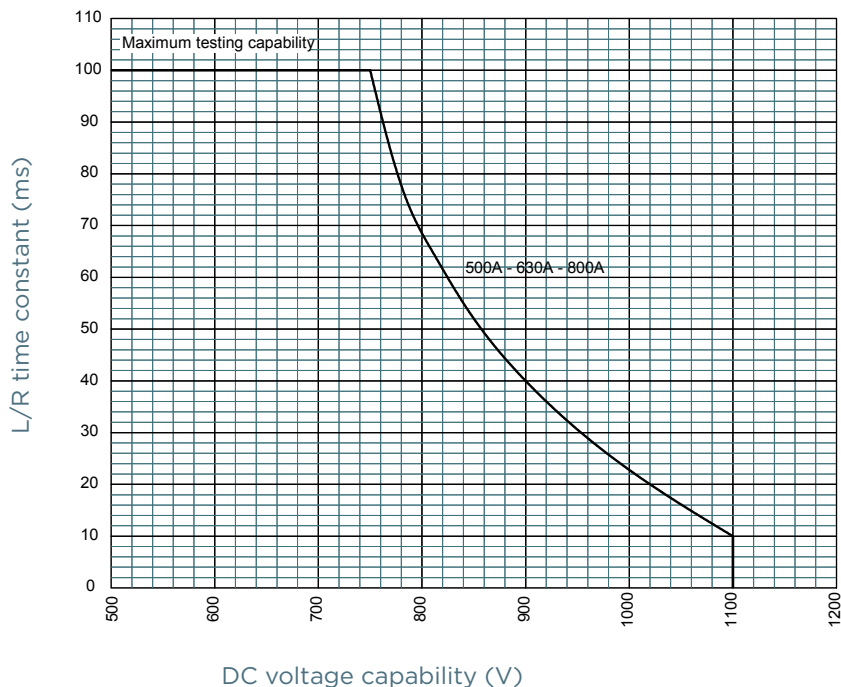

### Size 2x122 gR 900A-1000A

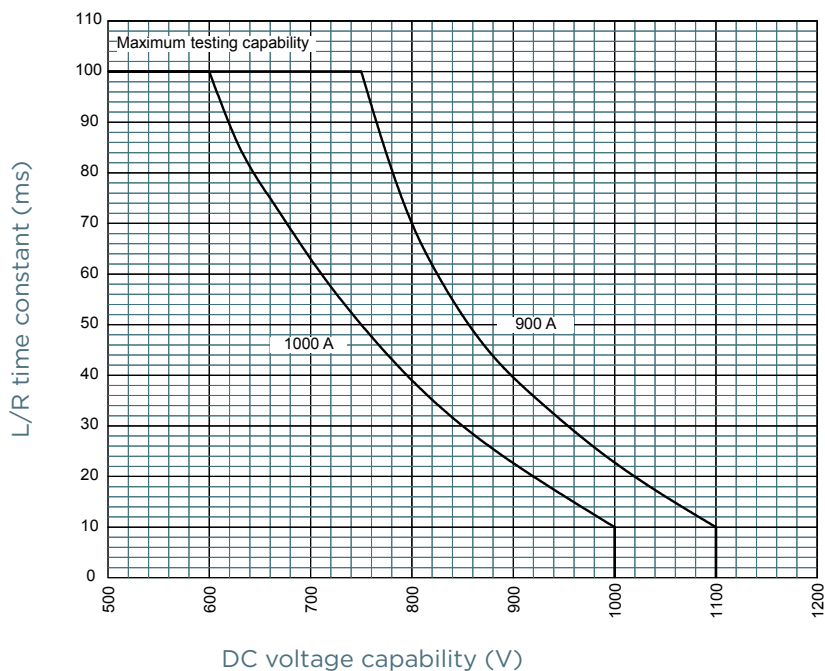

MERSEN reserves the right to change, update or correct, without notice, any information contained in this datasheet.

## L/R TIME CONSTANT VS DC VOLTAGE CAPABILITY

### Size 2x123 gR 1000A

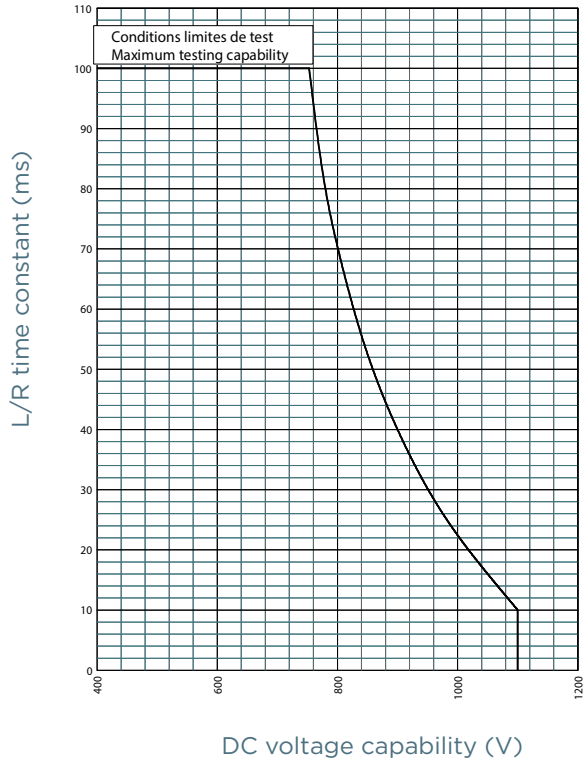

### Size 2x123 gR 1250-1500A

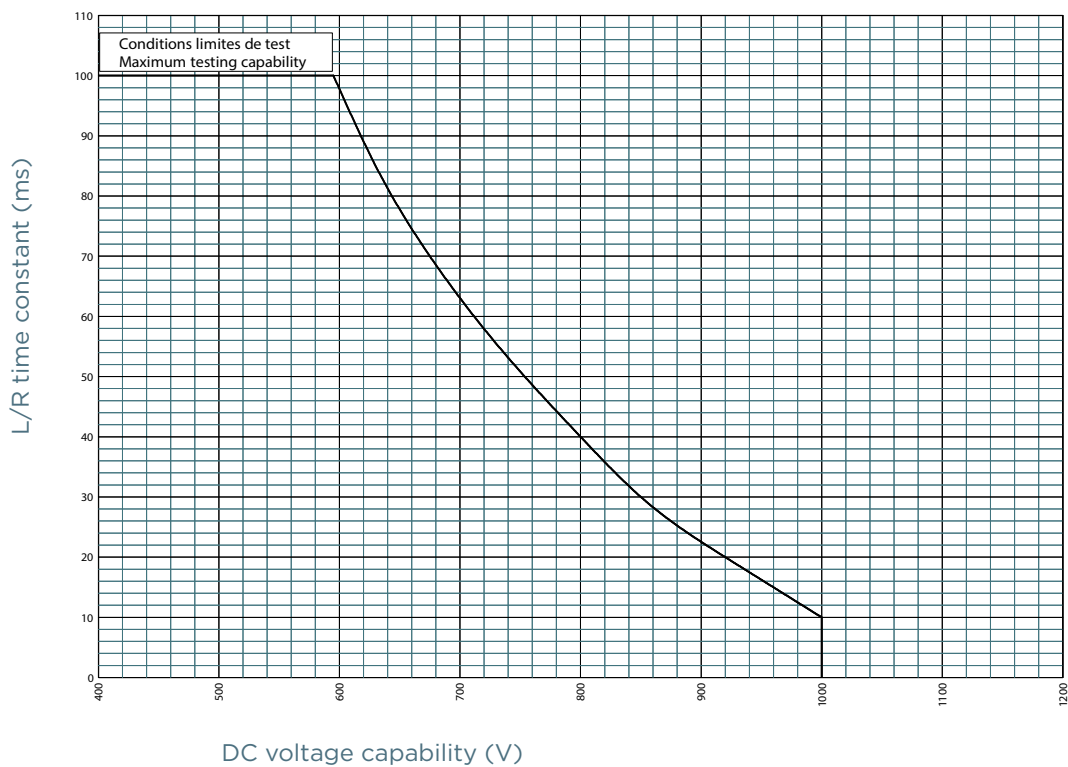

# Protistor® sizes 2x122 and 2x123 gR

750VDC (IEC)

## L/R TIME CONSTANT VS DC VOLTAGE CAPABILITY

### Size 2x123 gR 1600A

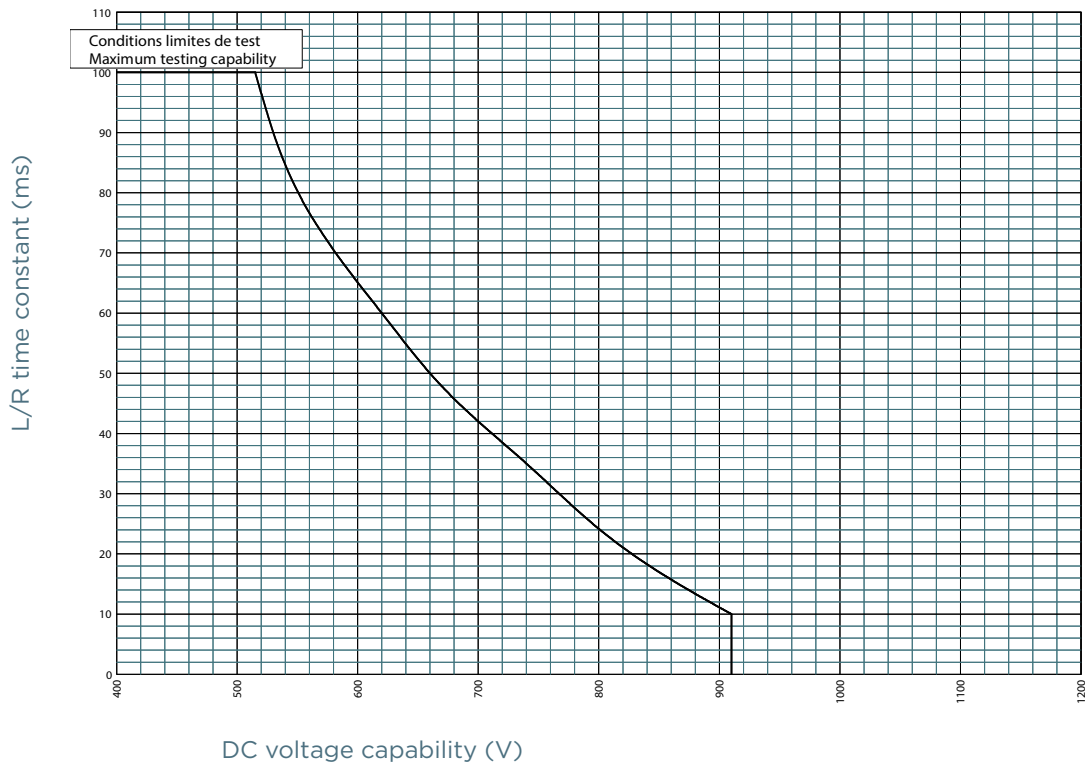

## POWER DISSIPATION

### Size 2x122 gR

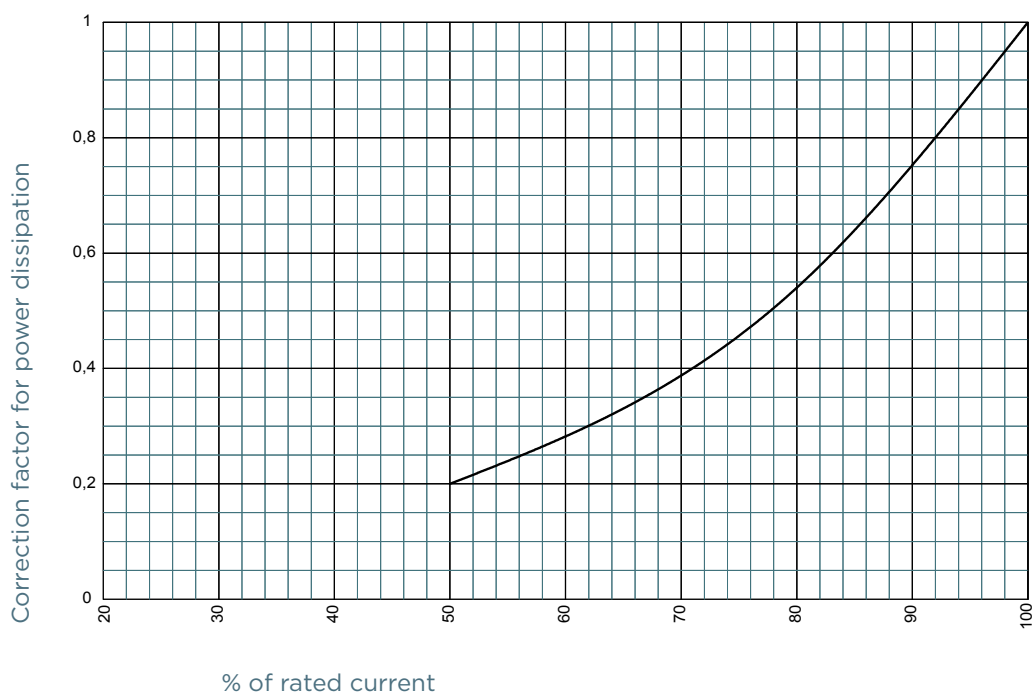

## POWER DISSIPATION

### Size 2x123 gR

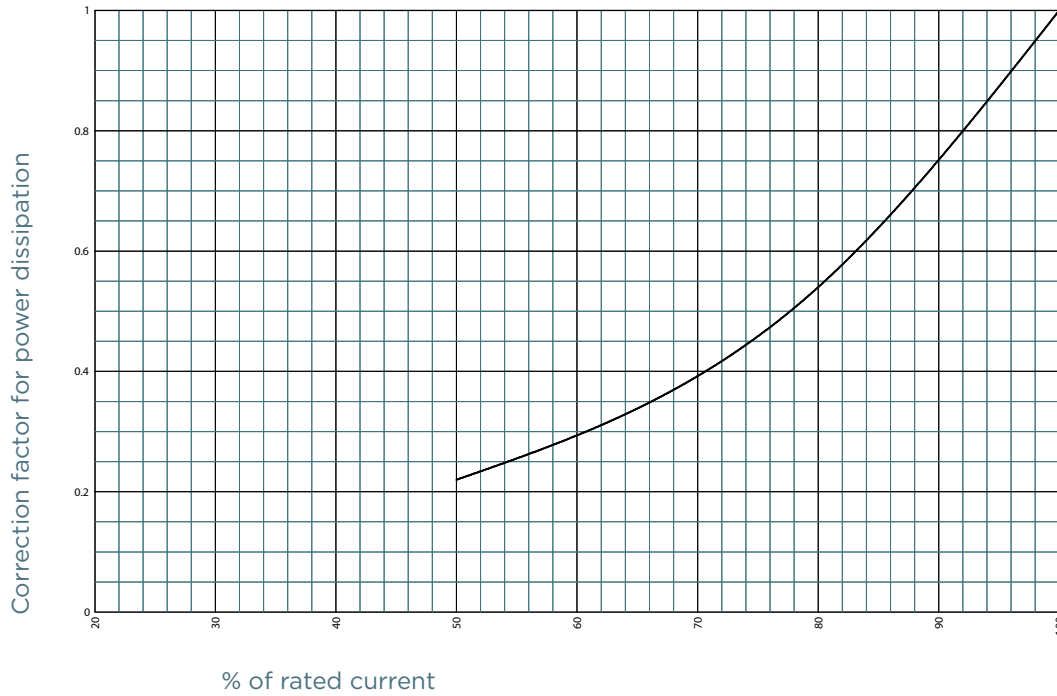

# Protistor® sizes 2x122 and 2x123 gR

750VDC (IEC)

## PEAK ARC VOLTAGE

### Size 2x122 & 2x123 gR

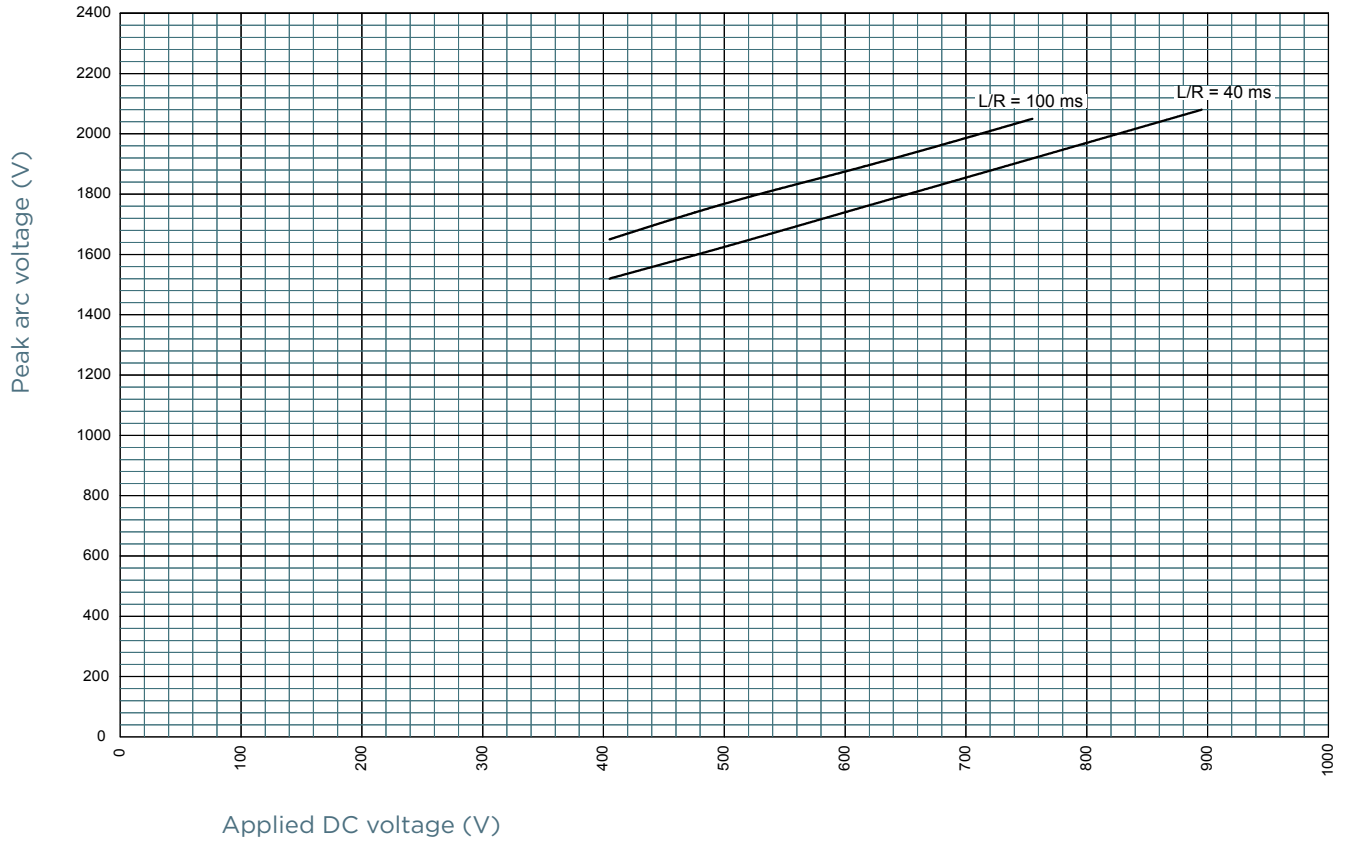

MERSEN reserves the right to change, update or correct, without notice, any information contained in this datasheet.

# Protistor® sizes 2x122 and 2x123 gR

750VDC (IEC)

## DIMENSIONS

### Size 2x122 threads terminals (TTF)

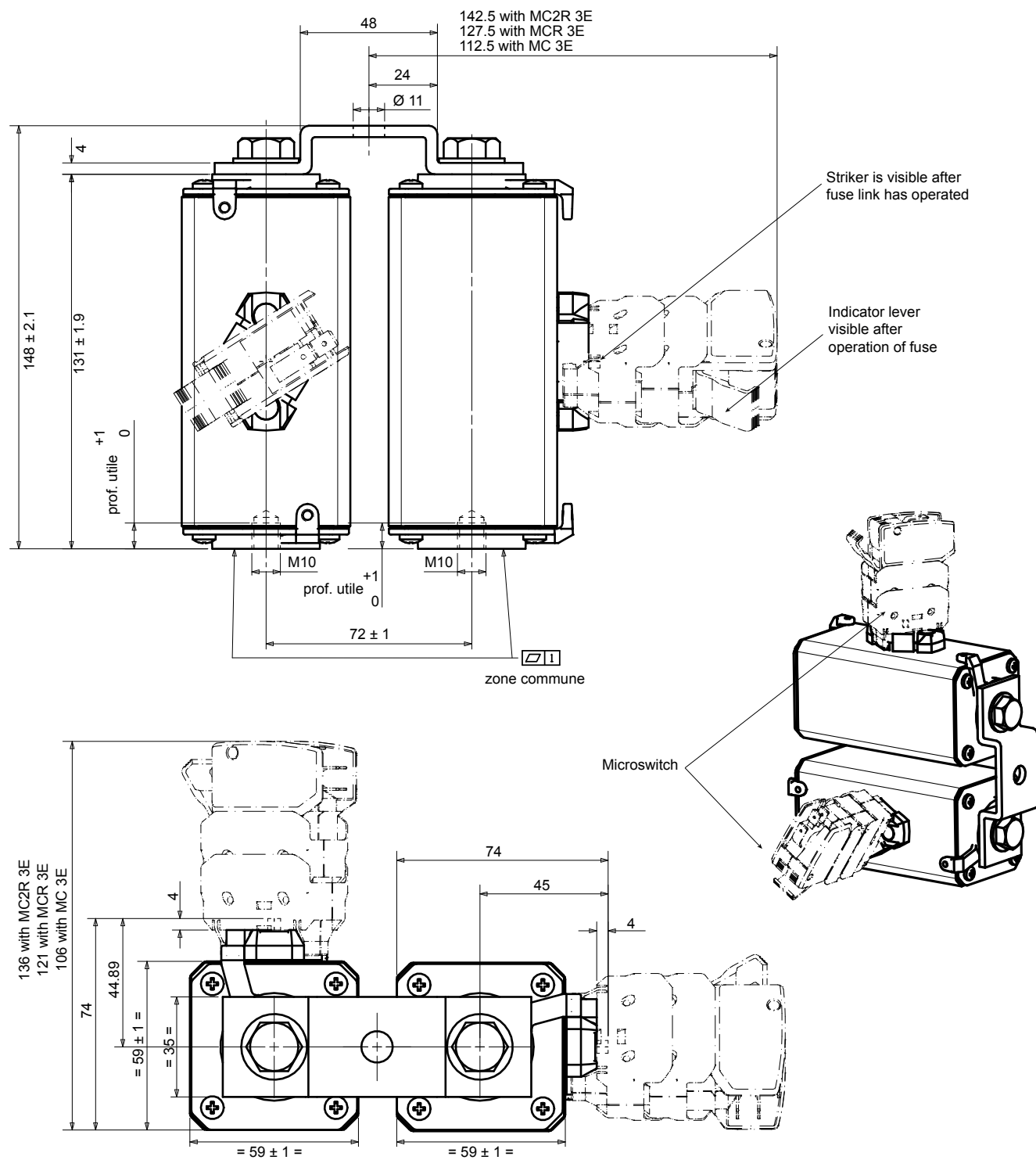

Dimensions in mm

