

## DC Square-body Fuses Sizes 300 - 302 - 2x302 SR size 2x302 - 2400V DC

SRD - SRF from 400 to 800 A

### Dimensions

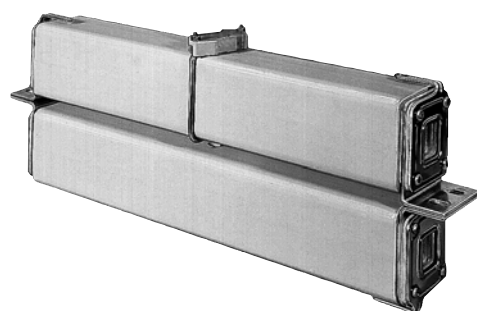
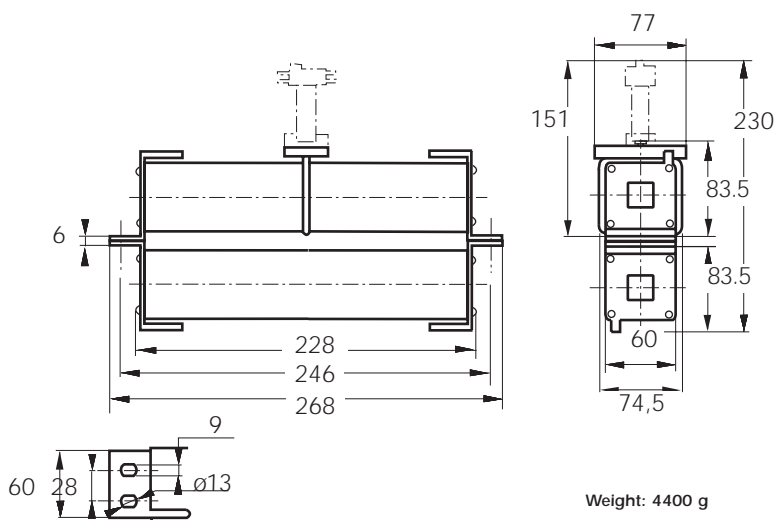

### Main Characteristics

Size	Current rating $I_N$ (A)	Breaking Capacity	Watts loss		Max. $I^2t$ @ 2000 V		Designation	Ref. Number	Catalog Number
			$0.8 I_N$ (W)	$I_N$ (W)	L/R = 15 ms (A <sup>2</sup> S)	L/R = 45 ms (A <sup>2</sup> S)			
2x302	400	@ 2400 V DC	160	313	155,000	265,000	CC 24 SRD 2302 QF 400	K084925	D2302SD24C400QF
	500	100 kA	189	376	275,000	480,000	CC 24 SRD 2302 QF 500	L084926	D2302SD24C500QF
	630	L/R = 15 ms	197	390	600,000	$10^6$	CC 24 SRD 2302 QF 630	M084927	D2302SD24C630QF
	700	@ 2000 V DC	200	393	920,000	$1.6 \cdot 10^6$	CC 24 SRD 2302 QF 700	N084928	D2302SD24C700QF
	800	100 kA L/R = 45 ms	205	395	780,000	$1.3 \cdot 10^6$	CC 24 SRF 2302 QF 800	T075296	D2302SF24C800QF

Microswitch MC 2R 3E 1-5N BS Ref. Number: J310025

Pack: 1 piece

# Protistor DC fuses

DC Square-body Fuses  
 Sizes 300 - 302 - 2x302  
 SR size 2x302 - 2400V DC



SRD - SRF from 400 to 800 A

## Electrical characteristics

### DC applications data

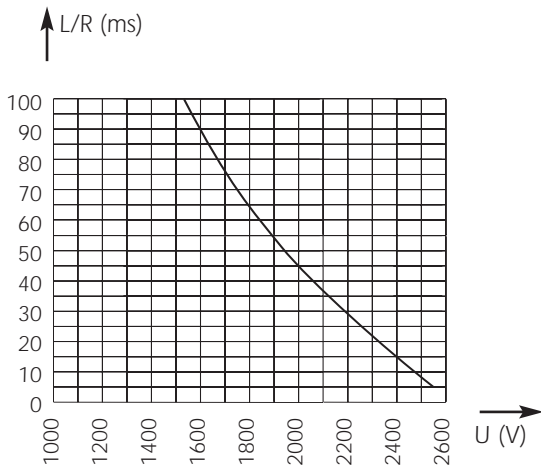

Above: Curve indicates maximum permissible value of time constant L/R as a function of DC working voltage

**Max. AC voltage (50/60 Hz):**  
 2000 V with breaking capacity of 80 kA

### Time vs. current characteristics

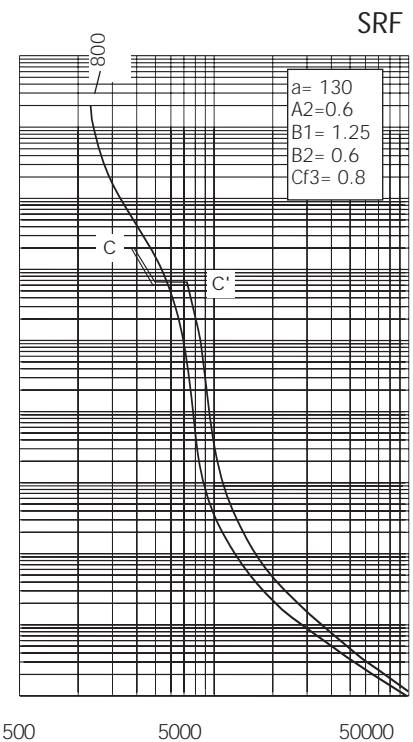
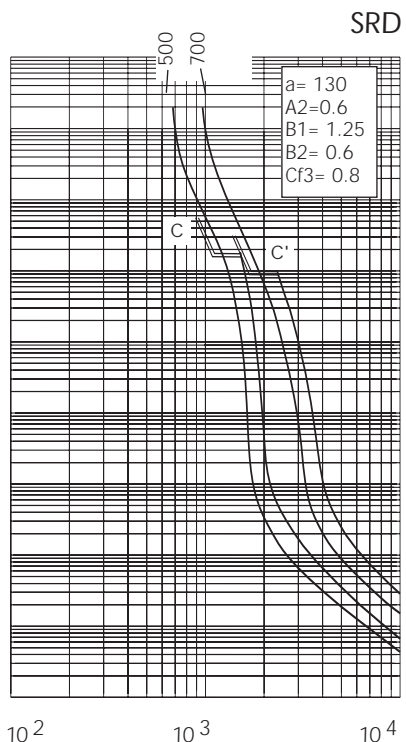
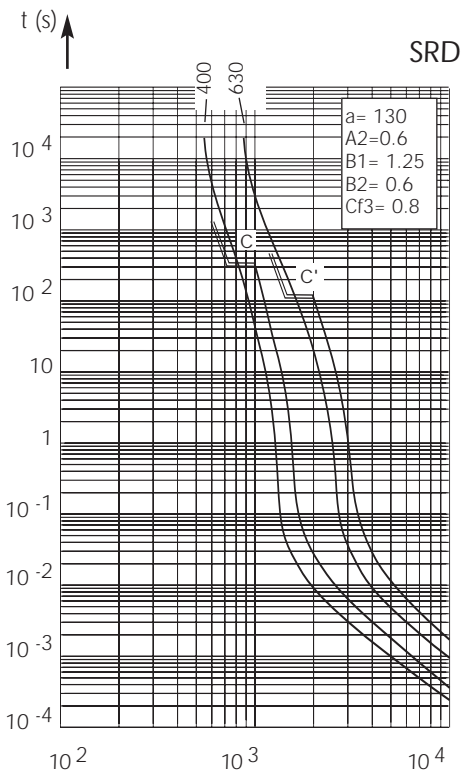

Above: Curves indicate, for each rated current, pre-arcing time vs. R.M.S. pre-arcing current.

### Peak arc voltage vs. working voltage

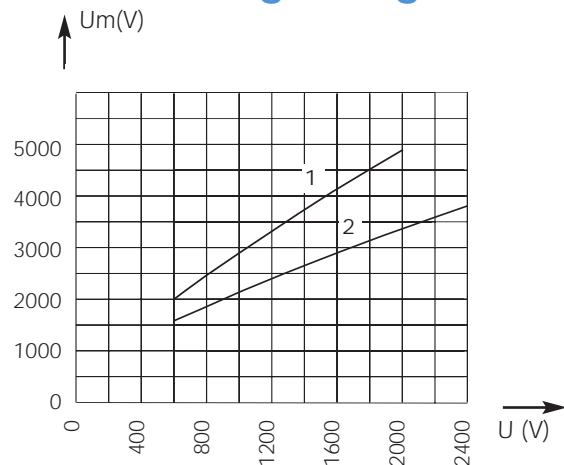

1 : L/R = 45 ms  
 2 : L/R = 15 ms

Above: Curves indicate for various time constants L/R the peak arc voltage which may appear across fuse terminals, vs. DC working voltage