

UltraSafe™ US22

Modular fuse-holders

FUSE HOLDERS, FUSE BASES AND SUPPORTS

UL/CSA FUSE HOLDERS



The innovative and comprehensive UltraSafe™ range of Mersen fuse-holders.

Modular fuse-holders are finger-safe under IEC standards to an IP20 grade of protection, including fuse changing (with the flick of a finger). Modular fuse-holders are available in 1, 2, 3 or 4 poles, with or without visual blown fuse indicator, in UL + IEC version.

Multi-pole units can also be field assembled by ordering pin-ties assembly kit. In this size, the range also offers the possibility to use microswitches (supplied with the holders or ordered separately) to allow remote indication.

UltraSafe™ range is made of tough and durable thermoplastic or thermoset material.

TECHNICAL DATA OVERVIEW

UL ratings AC	800 VAC, 125 A, 50 kA
UL ratings DC	1000 VDC, 125 A, 100 kA
Voltage AC	690 VAC
Voltage DC	690 VDC
Amper (A)	125 A
SCCR	100 kA
Mounting	Installation on to DIN rails to EN 60715
Product Size	for cylindrical fuse links 22x58
Number of poles	1-pole, 2-pole, 3-pole, 1+N, 3+N

FEATURES & BENEFITS

- Finger safe
- Degree of protection: IP20
- Optional visual blown fuse indicator & microswitch
- DIN rail mounting
- Modular design
- Lockable
- Multi-pole assembly kit available
- Sealable in closed and open position
- Plastic material UL94V2 mini
- Flame retardant materials with glow wire flammability index to 960°C

APPLICATIONS

- All circuits up to 750VAC for protection of motors, transformers, low voltage distribution, control circuits
- Non-load operation

STANDARDS

- UL Recognized Component, UL4248, guide IZLT2, file E52283
- CSA Certified C22.2, class 6225, file 32169
- IEC 60269-2 and IEC 60947-3
- RoHS Compliant
- Plastic material: NF 16101 & 16102 Requirement 2 Compliant



MERSEN reserves the right to change, update or correct, without notice, any information contained in this datasheet.

PRODUCT RANGE



US221

UltraSafe™ fuse holders for 22x58 fuse links, without indicator

Catalog number	Item number	Number of poles/phases	Design	Package	Weight
US223	R331169	3	triple pole	2	0.64 kg
US223N	X331174	3 + N	triple pole + neutral conductor	1	0.91 kg
US221	E331158	1	single pole	6	0.21 kg
US222	K331163	2	double pole	3	0.44 kg
US221N	H331161	1 + N	single pole + neutral conductor	3	0.45 kg



US223I

UltraSafe™ fuse holders for 22x58 fuse links, with indicator

Catalog number	Item number	Number of poles/phases	Design	Package	Weight
US221I	F331159	1	single pole	6	0.22 kg
US222I	L331164	2	double pole	3	0.33 kg
US223I	S331170	3	triple pole	2	0.44 kg



US222M

UltraSafe™ fuse holders for 22x58 fuse links, with auxiliary microswitch

Catalog number	Item number	Number of poles/phases	Design	Package	Weight
US221M	G331160	1	single pole	6	0.15 kg
US221NM	J331162	1 + N	single pole + neutral conductor	3	0.47 kg
US222M	M331165	2	double pole	3	0.46 kg
US222M2	P331167	2	double pole	3	0.46 kg
US223M	T331171	3	triple pole	2	0.67 kg
US223M2	W331173	3	triple pole	2	0.67 kg



US222MI

UltraSafe™ fuse holders for 22x58 fuse links, with indicator and auxiliary microswitch

Catalog number	Item number	Number of poles/phases	Design	Package	Weight
US221MI	Z1006203	1	single pole	6	0.22 kg
US222MI	N331166	2	double pole	3	0.46 kg
US223M2I	X1011974	3	triple pole	2	0.65 kg
US222M2I	Q331168	2	double pole	3	0.47 kg
US223MI	V331172	3	triple pole	2	0.68 kg

TECHNICAL DATA

	US22	US22I	US22M	US22MI
Size	22x58	22x58	22x58	22x58
Number of poles/phases	1, 1+N, 2, 3, 3+N	1, 2, 3	1, 1+N, 2, 3	1, 2, 3
UL ratings AC	800 VAC, 125 A, 50 kA	800 VAC, 125 A, 50 kA	800 VAC, 125 A, 50 kA	800 VAC, 125 A, 50 kA
UL ratings DC	1000 VDC, 125 A, 100 kA	1000 VDC, 125 A, 100 kA	1000 VDC, 125 A, 100 kA	1000 VDC, 125 A, 100 kA
Conventional free air thermal current with fuse links I_{th}	125 A	125 A	125 A	125 A
Power dissipation at I_{th}	9.5 W	9.5 W	9.5 W	9.5 W
Utilisation category	AC20B/DC20B	AC20B/DC20B	AC20B/DC20B	AC20B/DC20B
Rated insulation voltage U_i	750 V	750 V	750 V	750 V
SCCR	100 kA	100 kA	100 kA	100 kA
Rated impulse withstand voltage U_{imp}	8 kV	8 kV	8 kV	8 kV
Degree of protection	IP 20	IP 20	IP 20	IP 20
Voltage limit for blown fuse indicator	-	230 to 690V AC/DC	-	230 to 690V AC/DC
Indication System	-	with indicator	with auxiliary microswitch	with indicator and auxiliary microswitch
Operating temperature	-25°C to +60°C	-25°C to 60°C	-25°C to 60°C	-25°C to 60°C
Storage temperature	-25°C to +80°C	-25°C à 80°C	-25°C to 80°C	-25°C to 80°C
Connection	Max. tightening torque: 4Nm (35lbs-in) Rigid wire = 1.5-50mm ² (16-1AWG) Multistrand wire = 35mm ² (3AWG) PZ2 or flat 6.5x1.2mm screw drivers recommended (max. diameter 7mm)	Max. tightening torque: 4Nm (35lbs-in) Rigid wire = 1.5-50mm ² (16-1AWG) Multistrand wire = 35mm ² (3AWG) PZ2 or flat 6.5x1.2mm screw drivers recommended (max. diameter 7mm)	Max. tightening torque: 4Nm (35lbs-in) Rigid wire = 1.5-50mm ² (16-1AWG) Multistrand wire = 35mm ² (3AWG) PZ2 or flat 6.5x1.2mm screw drivers recommended (max. diameter 7mm)	Max. tightening torque: 4Nm (35lbs-in) Rigid wire = 1.5-50mm ² (16-1AWG) Multistrand wire = 35mm ² (3AWG) PZ2 or flat 6.5x1.2mm screw drivers recommended (max. diameter 7mm)

SPECIFIC USAGE CONDITIONS

Ambient temperature	>20°C	30°C	40°C	50°C	60°C
Derating factor (I_e)	1	0.95	0.9	0.8	0.7

No of poles (side by side)	1 to 3	4 to 6	>= 7
Derating factor of current (I_{th})	1	0.95	0.9

Nominal current of fuse-link gR	50 A	63 A	80 A	100 A	125 A	135 A
Max. operational current in fuse-holder	47 A	54 A	70 A	83 A	91 A	96 A
Cable wire section	10 mm ²	16 mm ²	25 mm ²	35 mm ²	50 mm ²	50 mm ²

DIMENSIONS

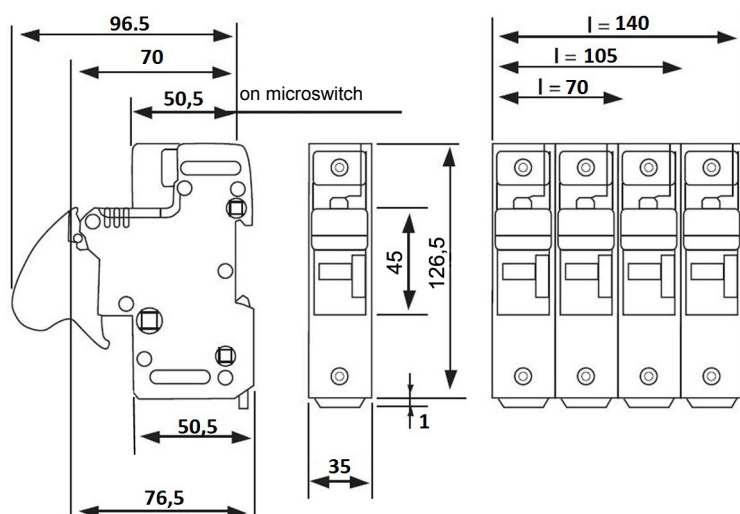

FUNCTIONS

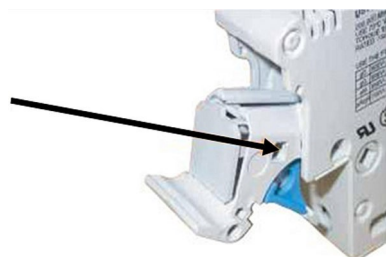

Indicator light kit for US22

With the indicator light a blown fuse can be quickly located if power is still on.

1. Carefully remove the cover with 2 screw drivers.

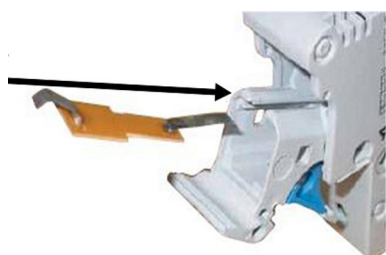

2. Slip the indicator light's to insert into the rails, being careful not to twist the contact tabs.

FUNCTIONS

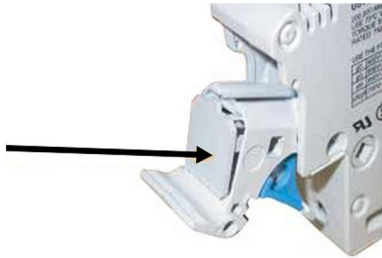

3. Put the cover back on.

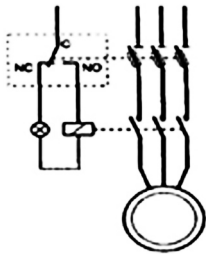

Auxiliary microswitch functions

Fuse melting: a fuse-holder containing a fuse with a striker sends out a signal when the fuse element melts.

Pre-isolation: when opening the fuse-holder, the microswitch sends a signal before the opening of the main contacts.

Presence: sends a signal when the holder is closed with no fuse in it.

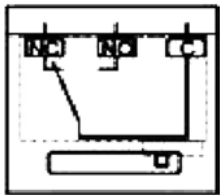

With the fuse in the handle closed state

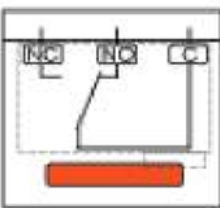

No fuse - Fuse blown in handle open

Characteristics

Rated insulation voltage: 250VAC

Rated operational current following IEC 60947-5 & -1

Utilization category AC15: 4A/24V, 4A/48V, 3A/127V, 2.5A/240V

Utilization category DC13: 3A/24V, 1A/48V, 0.2A/127V, 0.1A/240V

Minimum operational current and voltage: 1mA/4V AC or DC

Auxiliary microswitch is designed to operate equally well on dual-current (1mA 4V minimum) or medium-current (5A maximum) circuits. However, a given product should only be used to switch one type of circuit during its working life.

Connection: Faston lugs

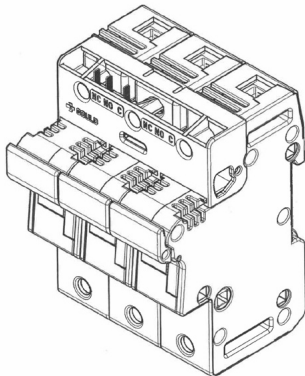

Auxiliary microswitch can only be mounted on previously prepared fuse disconnectors. Use of the auxiliary microswitch for fuse melting requires the use of fuses with strikers.

1 auxiliary microswitch

Auxiliary microswitch is designed to operate equally well on dual-current (1mA 4V minimum) or medium-current (5A maximum) circuits. However, a given product should only be used to switch one type of circuit during its working life.

Connection: Faston lugs

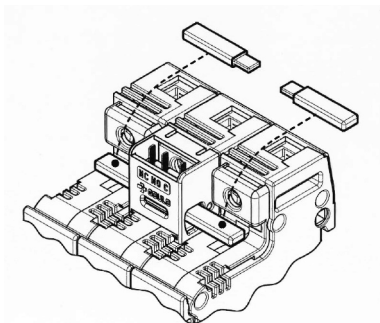

USMSW4

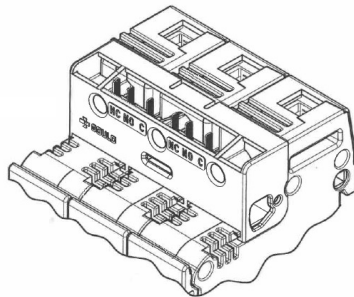

2 auxiliary microswitches

USMSW4 + US1422BP

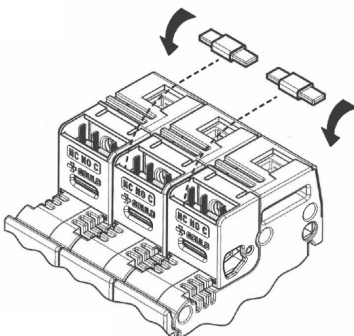

3 x USMSW4

ACCESSORIES

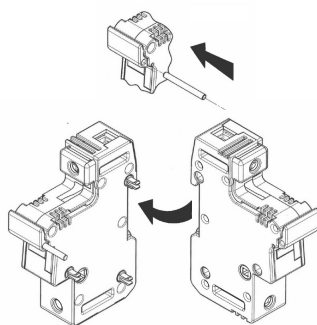

multiphase connection kit

Kit for multi phase connection

Catalog number	Item number	Design	Package
US22PAK	US22PAK	links for connection of multipole units	10

Auxiliary Switches

Catalog number	Item number	Design	Package	Weight
CMS22W2	CMS22W2	Auxiliary microswitch kit 3 poles CMS22	1	32 g
CMS22W3	CMS22W3	2 Auxiliary microswitches kit 3 poles CMS22Kit contact auxiliaire 3 pôles CMS22	1	35 g
USMSW4	USMSW4	Auxiliary contact kit 1 pole US22 kits contact auxiliaire 3 pôles US14	1	20 g



LOCK

Locking devices

Catalog number	Item number	Features	Package	Weight
LOCK	M223525	Padlock	1	0.48 kg

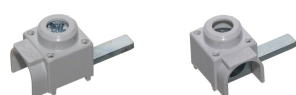

TBB1A

TBB1C



TBB23A

TBB23C

Power supply

Catalog number	Item number	Application	Features	Package	Weight
TBB1A	D210315	Max. rms current 90A	1 phase axial incoming power supply	50	10.1 g
TBB1C	E210316	Max. rms current 90A	1 phase lateral incoming power supply	50	10 g
TBB23A	F210317	Max. rms current 90A	2 & 3 phases axial incoming power supply	50	23.3 g
TBB23C	G210318	Max. rms current 90A	2 & 3 phases lateral incoming power supply	50	23.1 g

MERSEN reserves the right to change, update or correct, without notice, any information contained in this datasheet.

ACCESSORIES

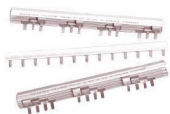

Wiring bars / Insulated bus bars

Catalog number	Item number	Application	Design	Package	Weight
Wiring bars / Insulated Busbars					
CMS22BB1F12	B210313	Max. rms current 90A, for installation of 12 modules	single pole 2 pôles	5	81 g
CMS22BB2F6	C210314	Max. rms current 150A, for installation of 6 modules	double pole un pôle	5	0.30 kg

Indication facilities

Catalog number	Item number	Features	Package	Weight
CMS1422LHI	A225653	Indicator light kit	1	10 g