

110.49 [4 11/32]

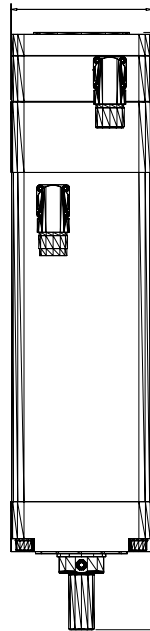

468.04 [18 27/64]

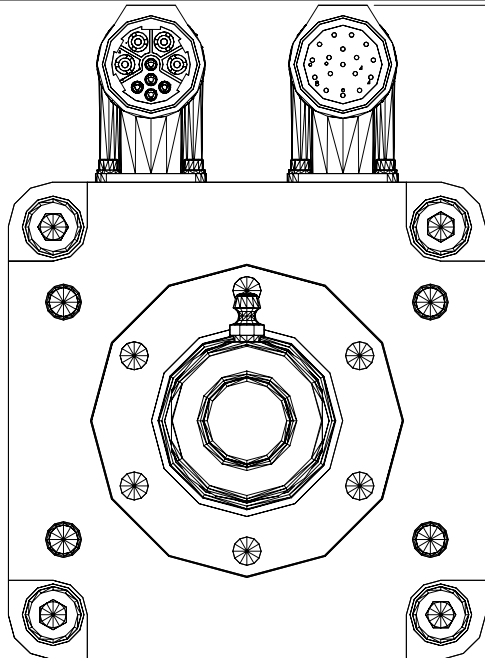

151.48 [5 31/32]

MPAI-x4150xM32A  
MP Series Heavy Duty  
Electric Cylinder, 110 mm  
Std. Mt., 150mm stroke,  
230V/460V Servo,  
Ball/Roller Screw

