

Solid State 24V DC Source Output Module

Catalog Number 1762-OB16

Table of Contents

Topic	Page
Additional Resources	2
Description	3
Installation	4
Mounting	5
System Assembly	7
Field Wiring Connections	8
I/O Memory Mapping	10
Specifications	11
North American Hazardous Location Approval	14

Additional Resources

Publication	Description
MicroLogix 1200 Programmable Controllers User Manual (Bulletin 1762 Controllers and Expansion I/O), publication 1762-UM001 .	Information on installing, wiring, and operating a MicroLogix 1200 Programmable Controller.
MicroLogix 1200 Programmable Controllers Installation Instructions, publication 1762-IN006 .	Installation guide for the MicroLogix 1200 Programmable Controller.
Industrial Automation Wiring and Grounding Guidelines, publication 1770-4.1 .	More information on proper wiring and grounding techniques.

If you would like a manual, you can:

- download a free electronic version from the Internet:
<http://literature.rockwellautomation.com>
- purchase a printed manual by contacting your local Allen-Bradley distributor or Rockwell Automation representative



Description

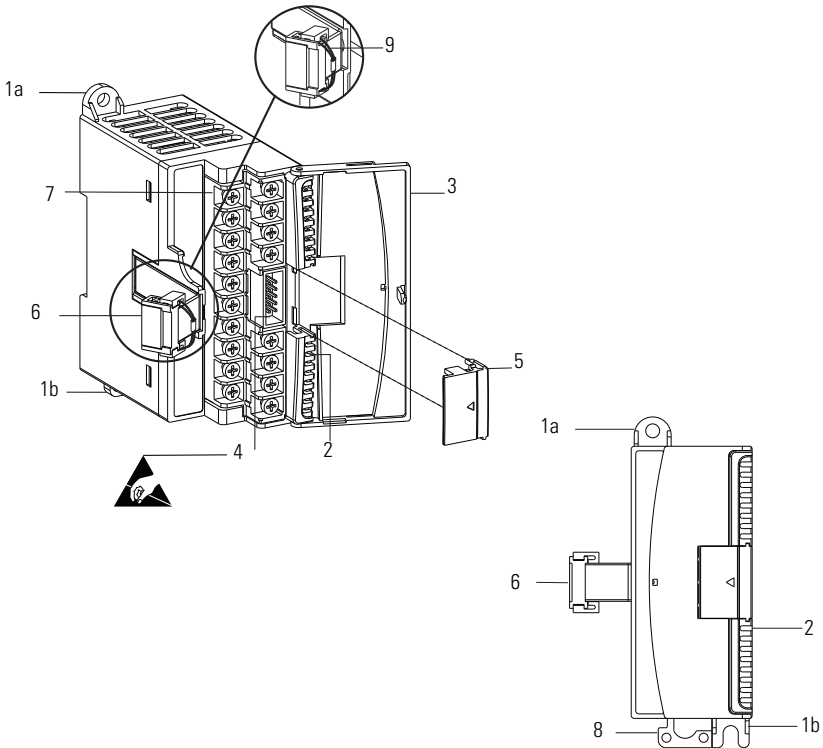

Item	Description	Item	Description
1a	upper panel mounting tab	5	bus connector cover
1b	lower panel mounting tab	6	flat ribbon cable with bus connector (female pins)
2	I/O diagnostic LEDs	7	terminal block
3	module door with terminal identification label	8	DIN rail latch
4	bus connector with male pins	9	pull loop

Installation

1762 I/O is suitable for use in an industrial environment when installed in accordance with these instructions. Specifically, this equipment is intended for use in clean, dry environments (Pollution degree 2⁽¹⁾) and to circuits not exceeding Over Voltage Category II⁽²⁾ (IEC 60664-1).⁽³⁾

Prevent Electrostatic Discharge

ATTENTION



Electrostatic discharge can damage integrated circuits or semiconductors if you touch bus connector pins. Follow these guidelines when you handle the module:

- Touch a grounded object to discharge static potential.
- Wear an approved wrist-strap grounding device.
- Do not touch the bus connector or connector pins.
- Do not touch circuit components inside the module.
- If available, use a static-safe work station.
- When not in use, keep the module in its static-shield box.

Remove Power

ATTENTION



Remove power before removing or installing this module. When you remove or install a module with power applied, an electrical arc may occur. An electrical arc can cause personal injury or property damage by:

- sending an erroneous signal to your system's field devices, causing unintended machine motion
- causing an explosion in a hazardous environment
- causing permanent damage to the module's circuitry

Electrical arcing causes excessive wear to contacts on both the module and its mating connector. Worn contacts may create electrical resistance.

(1) Pollution Degree 2 is an environment where, normally, only non-conductive pollution occurs except that occasionally a temporary conductivity caused by condensation shall be expected.

(2) Over Voltage Category II is the load level section of the electrical distribution system. At this level transient voltages are controlled and do not exceed the impulse voltage capability of the product's insulation.

(3) Pollution Degree 2 and Over Voltage Category II are International Electrotechnical Commission (IEC) designations.



Mounting

ATTENTION



Do not remove protective debris strip until after the module and all other equipment near the module is mounted and wiring is complete. Once wiring is complete and the module is free of debris, carefully remove protective debris strip. Failure to remove strip before operating can cause overheating.

Minimum Spacing

Maintain spacing from enclosure walls, wireways, adjacent equipment, etc. Allow 50.8 mm (2 in.) of space on all sides for adequate ventilation, as shown:

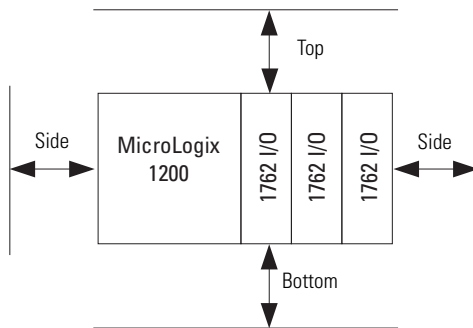

TIP

1762 expansion I/O may be mounted horizontally only.

ATTENTION



During panel or DIN rail mounting of all devices, be sure that all debris (metal chips, wire strands, etc.) are kept from falling into the module. Debris that fall into the module could cause damage when power is applied to the module.

DIN Rail Mounting

The module can be mounted using the following DIN rails: 35 x 7.5 mm (EN 50 022 - 35 x 7.5) or 35 x 15 mm (EN 50 022 - 35 x 15).

Before mounting the module on a DIN rail, close the DIN rail latch. Press the DIN rail mounting area of the module against the DIN rail. The latch will momentarily open and lock into place.

Use DIN rail end anchors (Allen-Bradley part number 1492-EA35 or 1492-EAH35) for vibration or shock environments.

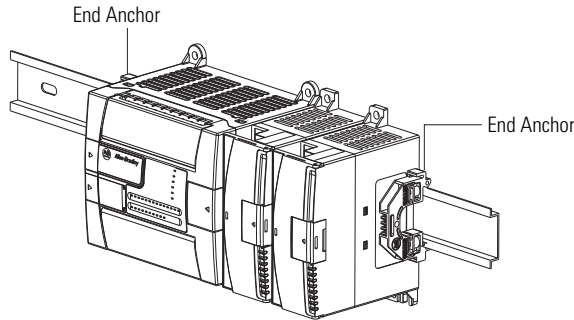

TIP

For environments with greater vibration and shock concerns, use the panel mounting method described below, instead of DIN rail mounting.

Panel Mounting

Use the dimensional template shown below to mount the module. The preferred mounting method is to use two M4 or #8 panhead screws per module. M3.5 or #6 panhead screws may also be used, but a washer may be needed to ensure a good mechanical contact. Mounting screws are required on every module.

For more than 2 modules: (number of modules - 1) x 40 mm (1.58 in.)

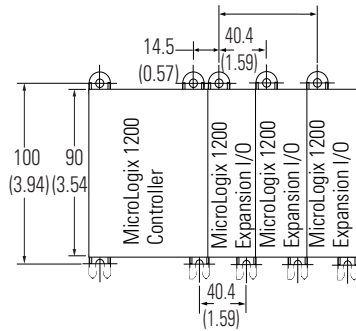

NOTE: All dimensions are in mm (inches). Hole spacing tolerance: ±0.4 mm (0.016 in.).

System Assembly

The expansion I/O module is attached to the controller or another I/O module by means of a flat ribbon cable after mounting as shown below.

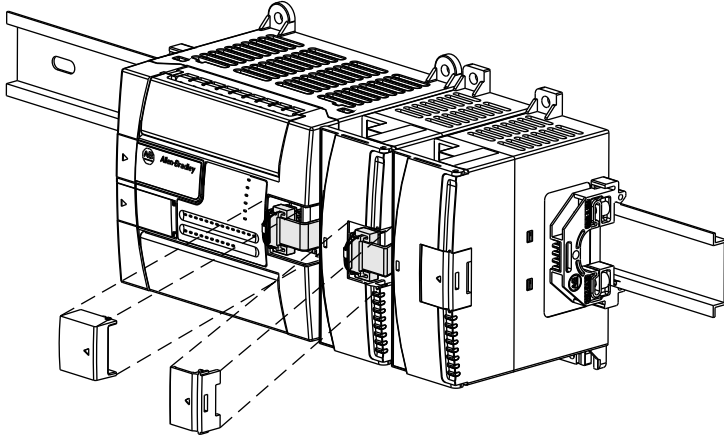
**TIP**

Use the pull loop on the connector to disconnect modules. Do not pull on the ribbon cable.

ATTENTION**EXPLOSION HAZARD**

- In Class I, Division 2 applications, the bus connector must be fully seated and the bus connector cover must be snapped in place.
- In Class I, Division 2 applications, all modules must be mounted in direct contact with each other as shown on Page 6. If DIN rail mounting is used, an end stop must be installed ahead of the controller and after the last 1762 I/O module.

Field Wiring Connections

Grounding the Module

This product is intended to be mounted to a well-grounded mounting surface such as a metal panel. Refer to *Industrial Automation Wiring and Grounding Guidelines*, Allen-Bradley publication [1770-4.1](#), for additional information.

Output Wiring

Basic wiring⁽¹⁾ of the 1762-OB16 is shown below.

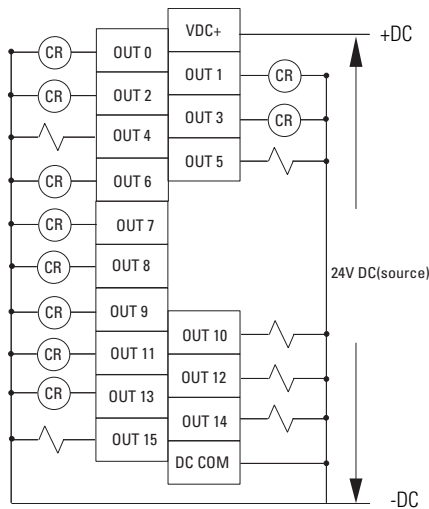

A write-on label is provided with the module. Mark the identification of each terminal with permanent ink, and slide the label back into the door.

ATTENTION



Be careful when stripping wires. Wire fragments that fall into a module could cause damage when power is applied. Once wiring is complete, ensure the module is free of all metal fragments.

(1) **Surge Suppression** – Connecting surge suppressors across your external inductive load will extend the life of the relay contacts. For additional details, refer to *Industrial Automation Wiring and Grounding Guidelines*, Allen-Bradley publication [1770-4.1](#).

ATTENTION

Miswiring of the module to an AC power source will damage the module.

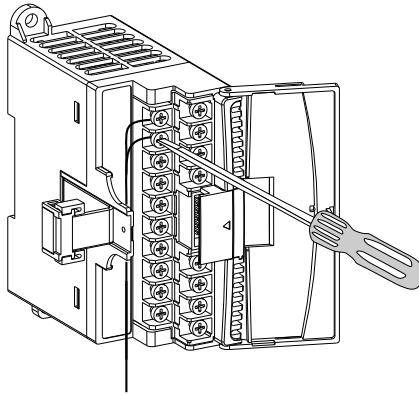
**TIP**

Finger-safe cover not shown for clarity.

Wiring the Finger-Safe Terminal Block

When wiring the terminal block, keep the finger-safe cover in place.

1. Route the wire under the terminal pressure plate. You can use the stripped end of the wire or a spade lug. The terminals will accept a 6.35 mm (0.25 in.) spade lug.
2. Tighten the terminal screw making sure the pressure plate secures the wire. Recommended torque when tightening terminal screws is 0.90 Nm (8 lb-in.).

TIP

If you need to remove the finger-safe cover, insert a screw driver into one of the square wiring holes and gently pry the cover off. If you wire the terminal block with the finger-safe cover removed, you will not be able to put it back on the terminal block because the wires will be in the way.

Wire Size and Terminal Screw Torque

Each terminal accepts up to two wires with the following restrictions:

Wire Type		Wire Size	Terminal Screw Torque
Solid	Cu-90 °C (194 °F)	#14...22 AWG	0.90 Nm (8 lb-in.)
Stranded	Cu-90 °C (194 °F)	#16...22 AWG	0.90 Nm (8 lb-in.)

I/O Memory Mapping

Output Data File

For each output module, the output data file contains the controller-directed state of the discrete output points. Bit positions 0...15 correspond to output terminals 0...15.

Word	Bit Position															
	15	14	13	12	11	10	9	8	7	6	5	4	3	2	1	0
0	w	w	w	w	w	w	w	w	w	w	w	w	w	w	w	w

w = write only

Addressing

The addressing scheme for 1762 Expansion I/O is shown below.

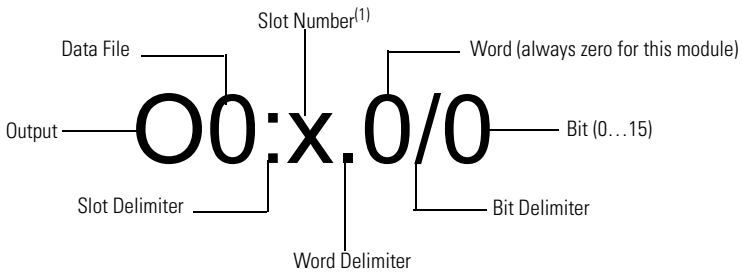

(1) I/O located on the controller (embedded I/O) is slot 0. I/O added to the controller (expansion I/O) begins with slot 1.

Specifications

General Specifications

Specification	Value
Dimensions, HxWxD	90 x 40.4 x 87 mm (height including mounting tabs is 110 mm) 3.54 x 1.59 x 3.43 in. (height including mounting tabs is 4.33 in.)
Approximate Shipping Weight (with carton)	235 g (0.52 lbs.)
Temperature, nonoperating	-40...85 °C (-40...185 °F)
Temperature, operating	0...55 °C (32...131 °F)
Humidity, operating	5...95% non-condensing
Altitude, operating	2000 m (6561 ft)
Vibration, operating	10...500 Hz, 5 g, 0.030 in. max. peak-to-peak, 2 hours per axis
Shock	Operating: 30 g panel mounted, 3 pulses per axis Non-Operating: 50 g panel mounted, 3 pulses per axis (40 g DIN Rail mounted)
Hazardous Environment Class	Class I, Division 2, Hazardous Location, Groups A, B, C, D ISA/ANSI 12.12.01 (C-UL under CSA C22.2 No. 213)
Radiated and Conducted Emissions	EN50081-2 Class A
ESD Immunity (IEC1000-4-2)	4 kV contact, 8 kV air, 4 kV indirect
Radiated Immunity (IEC1000-4-3)	10 V/m, 80...1000 MHz, 80% amplitude modulation, +900 MHz keyed carrier
Fast Transient Burst (IEC1000-4-4)	2 kV, 5 kHz
Surge Immunity (IEC1000-4-5)	2 kV common mode, 1 kV differential mode
Conducted Immunity (IEC1000-4-6)	10V, 0.15...80 MHz ⁽¹⁾

(1) Conducted Immunity frequency range may be 150 kHz...30 MHz if the Radiated Immunity frequency range is 30...1000 MHz.

Output Specifications

Specification	Value
Voltage Category	24V DC
Operating Voltage Range	20.4...26.4V DC
Number of Outputs	16
Bus Current Draw, max	175 mA @ 5V DC (0.88 W)
Heat Dissipation max	2.9 total Watts @ 30 °C (86°F) 2.1 total Watts @ 55 °C (131 °F)
Signal Delay (max.) – resistive load	turn-on = 0.1 ms turn-off = 1.0 ms
Off-State Leakage max	1.0 mA
On-State Current (min.)	1.0 mA
On-State Voltage Drop, max	1.0V DC
Continuous Current per Point, max	0.5A @ 55 °C (131 °F) 1.0A @ 30 °C (86 °F)
Continuous Current per Module, max	4.0A @ 55 °C (131 °F) 8.0A @ 30 °C (86 °F)
Surge Current, max	2.0 A (Repeatability is once every 2 s @ 55 °C (131 °F), once every second @ 30 °C (86 °F) for a duration of 10 ms.)
Power Supply Distance Rating	6 (The module may not be more than 6 modules away from the power supply.)
Isolated Groups	Group 1: Outputs 0 ... 15
Output Group to Backplane Isolation	Verified by one of the following dielectric tests: 1200V AC for 1 s or 1697V DC for 1 s. 75V DC working voltage (IEC Class 2 reinforced insulation)
Vendor I.D. Code	1
Product Type Code	7
Product Code	103

Sourcing Output - Source describes the current flow between the I/O module and the field device. Sourcing output circuits supply (source) current to sinking field devices. Field devices connected to the negative side (DC Common) of the field power supply are sinking field devices. Field devices connected to the positive side (+V) of the field supply are sourcing field devices.

Typical Loading Resistor - To limit the effects of leakage current through solid-state outputs, a loading resistor can be connected in parallel with your load. Use a 5.6k ohm, 1/4 W resistor for transistor outputs, 24V DC operation.

Recommended Surge Suppression - Use a 1N4004 diode reverse-wired across the load for transistor outputs switching 24V DC inductive loads. For additional information, refer to Industrial Automation Wiring and Grounding Guidelines, Allen-Bradley publication [1770-4.1](#).

Certifications



Certification (when product is marked) ⁽¹⁾	Value
c-UL-us	UL Listed Industrial Control Equipment, certified for US and Canada. UL Listed for Class I, Division 2 Group A,B,C,D Hazardous Locations, certified for U.S and Canada. See UL File E334470.
CE	European Union 2004/108/EC EMC Directive, compliant with: EN 61326-1; Meas./Control/Lab., Industrial Requirements EN 61000-6-2; Industrial Immunity EN 61000-6-4; Industrial Emissions EN 61131-2; Programmable Controllers (Clause 8, Zone A & B)
C-Tick	Australian Radiocommunications Act, compliant with: AS/NZS CISPR 11; Industrial Emissions
KC	Korean Registration of Broadcasting and Communications Equipment, compliant with: Article 58-2 of Radio Waves Act, Clause 3

(1) See product certification link at <http://www.rockwellautomation.com/products/certification> for Declaration of Conformity, Certificates, and other certification details.

North American Hazardous Location Approval

This equipment is suitable for use in Class I, Division 2, Groups A, B, C, D or non-hazardous locations only.

The following WARNING statement applies to use in hazardous locations.

<p>The following information applies when operating this equipment in hazardous locations:</p>	<p>Informations sur l'utilisation de cet équipement en environnements dangereux:</p>
<p>Products marked "CL I, DIV 2, GP A, B, C, D" are suitable for use in Class I Division 2 Groups A, B, C, D, Hazardous Locations and nonhazardous locations only. Each product is supplied with markings on the rating nameplate indicating the hazardous location temperature code. When combining products within a system, the most adverse temperature code (lowest "T" number) may be used to help determine the overall temperature code of the system. Combinations of equipment in your system are subject to investigation by the local Authority Having Jurisdiction at the time of installation.</p>	<p>Les produits marqués "CL I, DIV 2, GP A, B, C, D" ne conviennent qu'à une utilisation en environnements de Classe I Division 2 Groupes A, B, C, D dangereux et non dangereux. Chaque produit est livré avec des marquages sur sa plaque d'identification qui indiquent le code de température pour les environnements dangereux. Lorsque plusieurs produits sont combinés dans un système, le code de température le plus défavorable (code de température le plus faible) peut être utilisé pour déterminer le code de température global du système. Les combinaisons d'équipements dans le système sont sujettes à inspection par les autorités locales qualifiées au moment de l'installation.</p>
<p>WARNING</p> 	<p>EXPLOSION HAZARD</p> <ul style="list-style-type: none"> • Substitution of components may impair suitability for Class I, Division 2. • Do not replace components or disconnect equipment unless power has been switched off. • Do not connect or disconnect components unless power has been switched off. • This product must be installed in an enclosure. • In Class I, Division 2 applications, the bus connector must be fully seated and the bus connector cover must be snapped in place. • In Class I, Division 2 applications, all modules must be mounted in direct contact with each other as shown on Page 6. If DIN rail mounting is used, an end stop must be installed ahead of the controller and after the last 1762 I/O module. • All wiring must comply with N.E.C. article 501-4(b). • The interior of the enclosure must be accessible only by the use of a tool. • For applicable equipment (relay modules, etc.), exposure to some chemicals may degrade the sealing properties of materials used in the following devices: Relays, Epoxy. It is recommended that the User periodically inspect these devices for any degradation of properties and replace the module if degradation is found.
<p>AVERTISSEMENT</p> 	<p>RISQUE D'EXPLOSION</p> <ul style="list-style-type: none"> • La substitution de composants peut rendre cet équipement impropre à une utilisation en environnement de Classe 1, Division 2. • Ne pas remplacer de composants ou déconnecter l'équipement sans s'être assuré que l'alimentation est coupée. • Ne pas connecter ou déconnecter des composants sans s'être assuré que l'alimentation est coupée. • Ce produit doit être installé dans une armoire. • Pour les applications de Classe I, Division 2, le connecteur de bus doit être correctement installé et son couvercle enclenché. • Pour les applications de Classe 1, Division 2, tous les modules doivent être installés en contact direct les uns avec les autres, comme indiqué page 6. Si on utilise le montage sur rail DIN, une butée doit être placée à l'avant de l'automate et après la dernière unité d'E/S 1762.

Notes:



Rockwell Automation Support

Rockwell Automation provides technical information on the Web to assist you in using its products. At <http://www.rockwellautomation.com/support/>, you can find technical manuals, a knowledge base of FAQs, technical and application notes, sample code and links to software service packs, and a MySupport feature that you can customize to make the best use of these tools.

For an additional level of technical phone support for installation, configuration and troubleshooting, we offer TechConnect support programs. For more information, contact your local distributor or Rockwell Automation representative, or visit <http://www.rockwellautomation.com/support/>.

Installation Assistance

If you experience a problem within the first 24 hours of installation, please review the information that's contained in this manual. You can also contact a special Customer Support number for initial help in getting your product up and running.

United States or Canada	1.440.646.3434
Outside United States or Canada	Use the Worldwide Locator at http://www.rockwellautomation.com/support/americas/phone_en.html , or contact your local Rockwell Automation representative.

New Product Satisfaction Return

Rockwell Automation tests all of its products to ensure that they are fully operational when shipped from the manufacturing facility. However, if your product is not functioning and needs to be returned, follow these procedures.

United States	Contact your distributor. You must provide a Customer Support case number (call the phone number above to obtain one) to your distributor to complete the return process.
Outside United States	Please contact your local Rockwell Automation representative for the return procedure.

Documentation Feedback

Your comments will help us serve your documentation needs better. If you have any suggestions on how to improve this document, complete this form, publication [RA-DU002](#), available at <http://www.rockwellautomation.com/literature/>.

Allen-Bradley, Rockwell Automation, MicroLogix, and TechConnect are trademarks of Rockwell Automation, Inc.

Trademarks not belonging to Rockwell Automation are property of their respective companies.

Rockwell Otomasyon Ticaret A.Ş., Kar Plaza İş Merkezi E Blok Kat:6 34752 İçerenköy, İstanbul, Tel: +90 (216) 5698400
www.rockwellautomation.com

Power, Control and Information Solutions Headquarters

Americas: Rockwell Automation, 1201 South Second Street, Milwaukee, WI 53204-2496 USA, Tel: (1) 414.382.2000, Fax: (1) 414.382.4444
Europe/Middle East/Africa: Rockwell Automation, Vorstlaan/Boulevard du Souverain 36, 1170 Brussels, Belgium, Tel: (32) 2 663 0600, Fax: (32) 2 663 0600
Asia Pacific: Rockwell Automation, Level 14, Core F, Cyberport 3, 100 Cyberport Road, Hong Kong, Tel: (852) 2887 4788, Fax: (852) 2508 1846

Publication 1762-IN011B-EN-P - June 2013

Supersedes Publication 1762-IN011A-EN-P - July 2000

Copyright © 2013 Rockwell Automation, Inc. All rights reserved.