

56.12 [2 13/64]

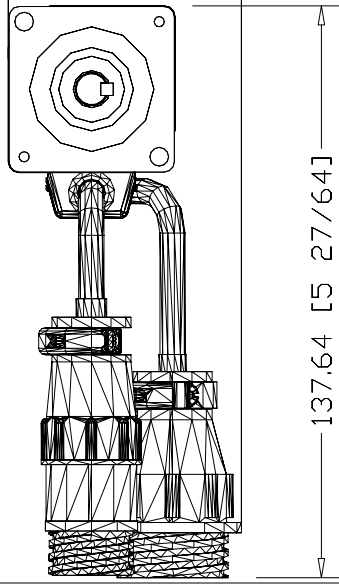

137.64 [5 27/64]

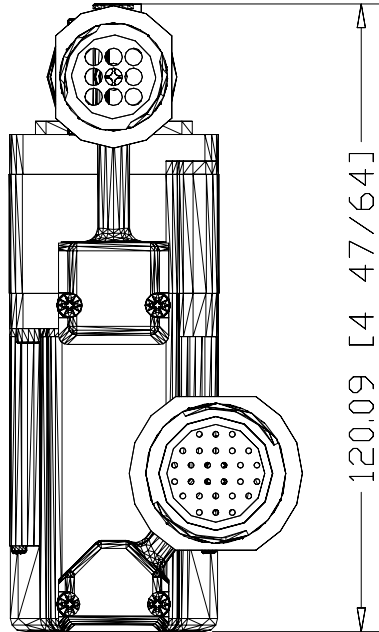

120.09 [4 47/64]

TLY-A120P-BJ64AA

Servo Motor, NEMA 17,
5000 rpm, Absolute
Encoder, Battery-Backed,
Multi-Turn, IP65 housing,
w/Brake

