

56.19 [2 7/32]

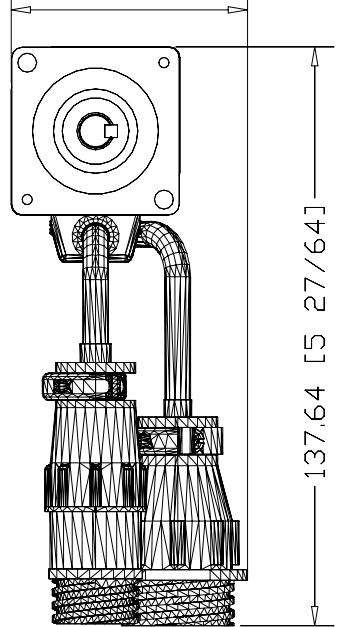

137.64 [5 27/64]

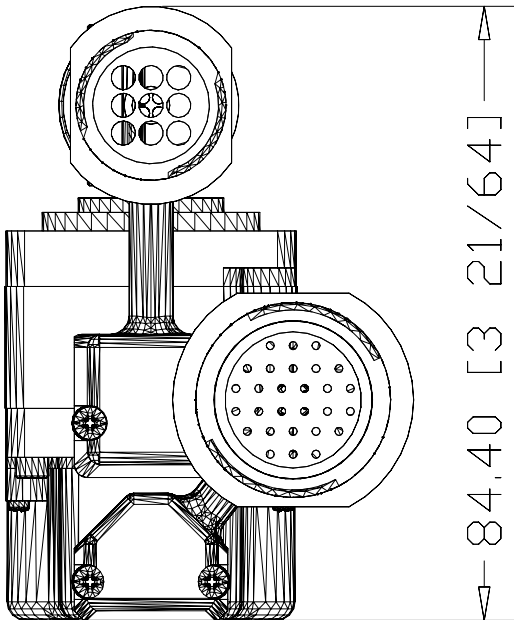

84.40 [3 21/64]

TLY-A110P-BJ64AA

Servo Motor, NEMA 17,
5000 rpm, Absolute
Encoder, Battery-Backed,
Multi-Turn, IP65 housing,
w/Brake

