

Fieldbus System

(Output device for driving 5-port solenoid valves)



Space-saving installation

Compact
Approx.

28 mm

Actual size

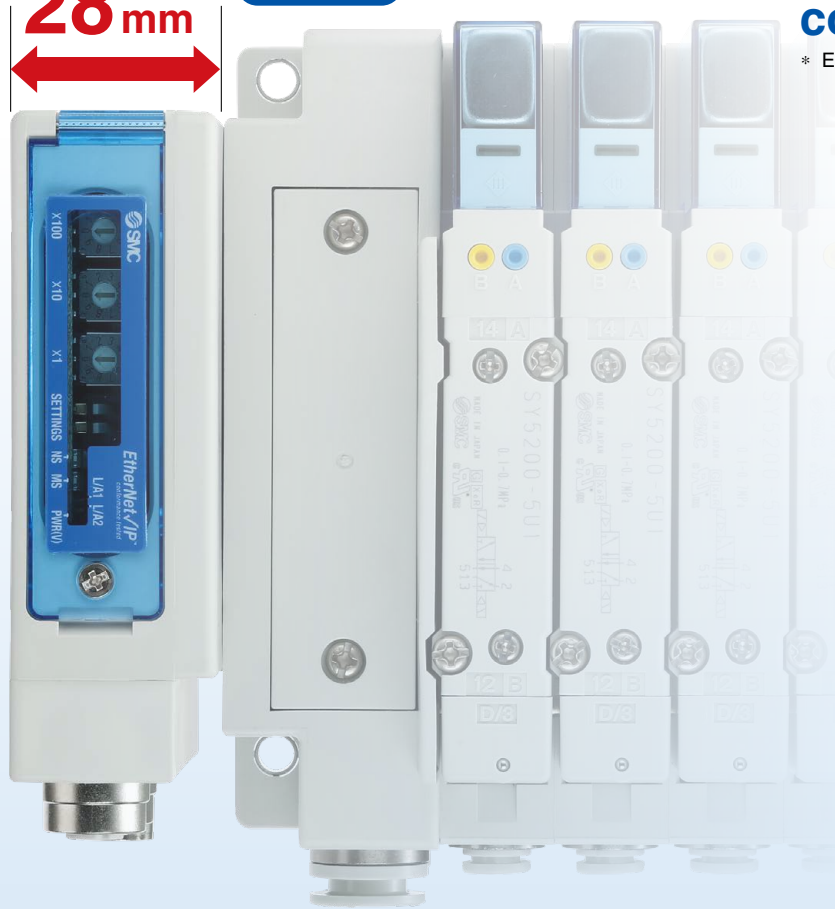

- IO-Link compatible
- IP67

* For units with a D-sub connector, and when connected to S0700 manifolds, it is IP40.

- Drives up to 32 solenoids
- Daisy-chain wiring communication

* Excludes the units compatible with IO-Link

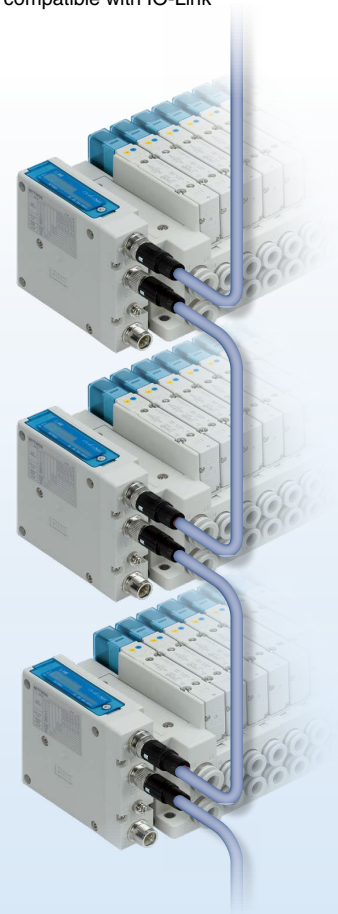

<Compatible Protocols>

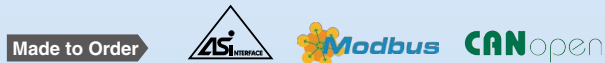

Made to Order

Please contact SMC for details on compatible products.

New A functional safety standard compliant product has been added. (PROFIsafe compatible)

- Product certification obtained by a third party (IEC 61508/62061 SIL 3, ISO 13849 PL e Cat. 3)
- Safety output for valve control

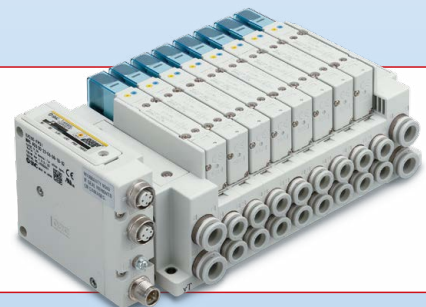

EX260 Series



CAT.E02-25D

Manifold length reduced by approx. 53 mm

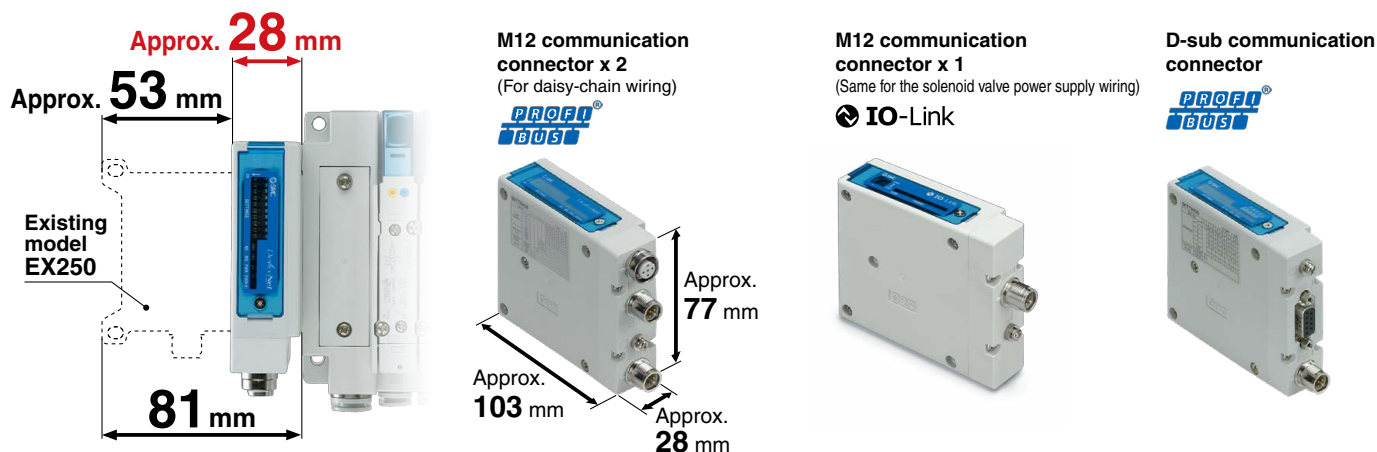

Daisy-chain wiring communication is possible.*1

A branch connector is not necessary/Reduced wiring space

*1 Excludes the units compatible with IO-Link

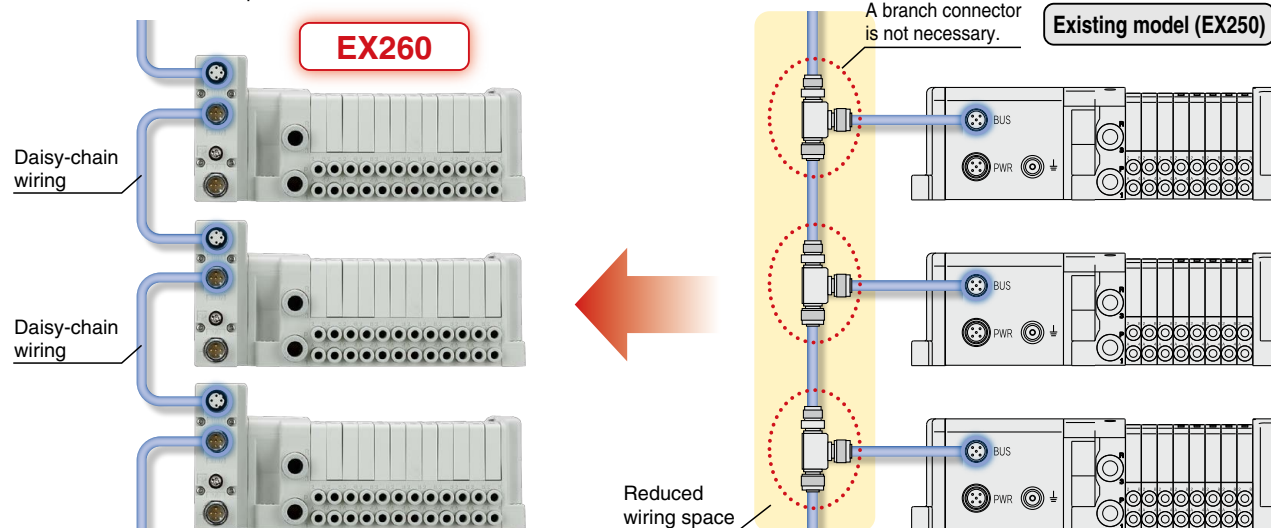

Wiring and piping from the same direction is possible. (for side ported)

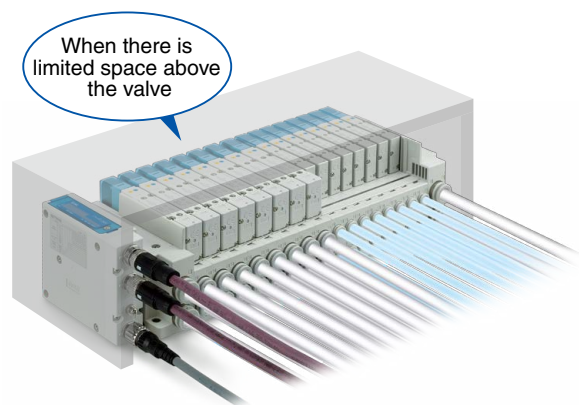

An external terminating resistor is not necessary.

(Only available for M12 PROFIBUS DP, CC-Link communication connectors)

ON/OFF switching is possible with an internal terminating resistor. An external terminating resistor is not necessary.

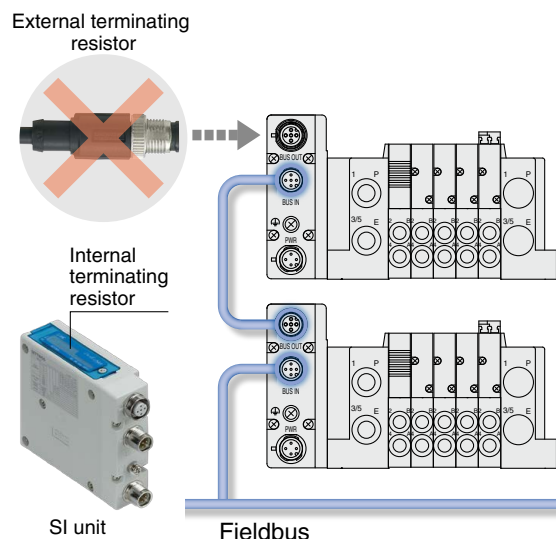

Product Specification Variations

| | | | DeviceNet | CC-Link | | EtherNet/IP | EtherCAT | ETHERNET POWERLINK | IO-Link | |
|-------------------------|-------|---|-----------|---------|---|-------------|----------|--------------------|---------|---|
| Number of outputs | 16 | ● | ● | ● | ● | ● | ● | ● | | |
| | 32 | ● | ● | ● | ● | ● | ● | ● | ● | ● |
| Output polarity | PNP | ● | ● | ● | ● | ● | ● | ● | ● | ● |
| | NPN | ● | ● | ● | ● | ● | ● | ● | ● | ● |
| Communication connector | M12 | ● | ● | ● | ● | ● | ● | ● | ● | ● |
| | D-sub | ● | | | | | | | | |

Applicable Valve Series and Compatible Protocols

| Fieldbuses & Industrial Ethernet | | | DeviceNet | CC-Link | | EtherNet/IP | EtherCAT | ETHERNET POWERLINK | IO-Link |
|----------------------------------|---------------------------------------|--------------------------|--|--------------------------|-----------------|-------------|----------|--------------------|---------|
| Series | Flow rate characteristics (4/2 → 5/3) | Max. number of solenoids | Power consumption [W] | Applicable cylinder size | C [dm³/(s·bar)] | | b | | |
| | | | | | C [dm³/(s·bar)] | b | | | |
| IP67 *1 | SY3000 | 32 | 0.35 (Standard) 0.1 (With power-saving circuit) | ø50 | 1.6 | 0.19 | CE | c RU US | |
| | SY5000 | | | | 3.6 | 0.17 | | | |
| | SY7000 | | | | 5.9 | 0.20 | | | |
| IP67 *1, *2 | JSY1000 | 32 | 0.2 (With power-saving circuit) 0.4 (Standard) 0.1 (With power-saving circuit) | ø40 | 0.91 | 0.48 | CE | | |
| | JSY3000 | | | | 2.77 | 0.27 | | | |
| | JSY5000 | | | | 6.59 | 0.22 | | | |
| IP40 | S0700 *3 | 32 | 0.35 | ø25 | 0.37 | 0.39 | CE | | |
| IP67 *1 | SV1000 *3 | 32 | 0.6 | ø40 | 1.1 | 0.35 | CE | c RU US | |
| | SV2000 *3 | | | | 2.4 | 0.18 | | | |
| | SV3000 *3 | | | | 4.3 | 0.21 | | | |
| IP67 *1 | VQC1000 | 24 | 0.4 (Standard) 0.95 (Standard) 0.4 (Low-wattage type) | ø40 | 1.0 | 0.30 | CE | | |
| | VQC2000 | | | | 3.2 | 0.30 | | | |
| | VQC4000 | | | 7.3 | 0.38 | | | | |
| | VQC5000 | | | 17 | 0.31 | | | | |
| | | | | ø63 | | | | | |
| | | | | ø160 | | | | | |
| | | | | ø180 | | | | | |

Safety Communication The use of validated products may be required for valve manifolds used in the safety-related parts of equipment which is compliant with safety standard ISO 13849. For validated products, please contact your SMC sales representative.

| Series | Flow rate characteristics (4/2 → 5/3) | Max. number of solenoids | Power consumption [W] | Applicable cylinder size | C [dm³/(s·bar)] | |
|-------------|---------------------------------------|--------------------------|--|--------------------------|-----------------|------|
| | | | | | C [dm³/(s·bar)] | b |
| IP67 | SY3000 | 32 | 0.35 (Standard) 0.1 (With power-saving circuit) | ø50 | 1.6 | 0.19 |
| | SY5000 | | | | 3.6 | 0.17 |
| | SY7000 | | | | 5.9 | 0.20 |
| IP67 *2 | JSY1000 | 32 | 0.2 (With power-saving circuit) 0.4 (Standard) 0.1 (With power-saving circuit) | ø40 | 0.91 | 0.48 |
| | JSY3000 | | | | 2.77 | 0.27 |
| | JSY5000 | | | | 6.59 | 0.22 |
| IP67 | VQC1000 | 24 | 0.4 (Standard) 0.95 (Standard) 0.4 (Low-wattage type) | ø40 | 1.0 | 0.30 |
| | VQC2000 | | | | 3.2 | 0.30 |
| | VQC4000 | | | 7.3 | 0.38 | |
| | VQC5000 | | | 17 | 0.31 | |
| | | | | ø63 | | |
| | | | | ø160 | | |
| | | | | ø180 | | |

*1 Units with a D-sub communication connector are IP40.
 *2 The JSY1000 is IP40.
 *3 There is no manifold part number setting for the IO-Link compatible SI units.

IO-Link compatible

Integratable with various existing networks

IO-Link devices can be easily connected to various networks via the IO-Link master, which acts as a gateway between IO-Link communication and various Fieldbuses. Solenoid valves can be connected for communication without relying upon a Fieldbus or PLC.

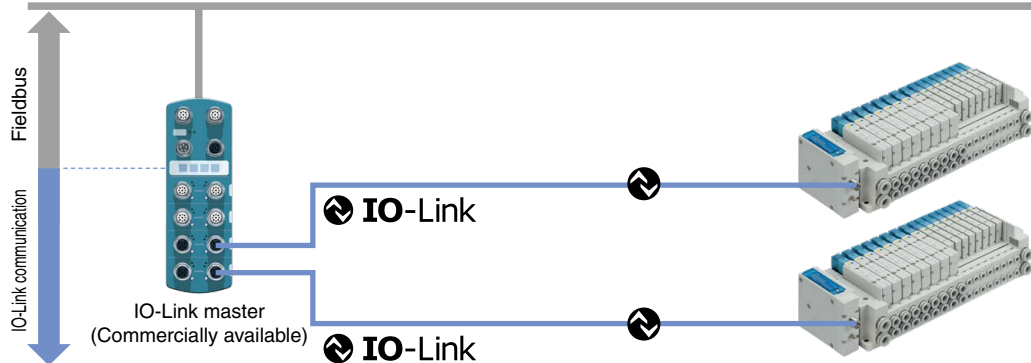

Can be connected using a single general-purpose cable, resulting in a reduction in the space required for wiring



Port class B compliant

Port class B

IO-Link master (Commercially available)

- Connect the IO-Link master port to the device using a 1:1 configuration.
- Connect using an M12 round connector.
- Maximum cable length: 20 m
- Special communication cables are not necessary.
- In order to connect the SI unit using a single cable, use a port class B type IO-Link master.

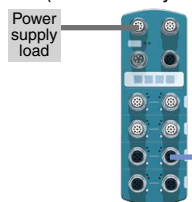

Port class A

IO-Link master (Commercially available)

General-purpose 5-wire unshielded cables are used for connection. The signal wire and valve power supply wire can be connected with the same cable.



SI unit/Connector pin arrangement

| Pin no. | SI unit port pin function (Port class B) |
|---------|--|
| 1 | +24 V for control unit |
| 2 | +24 V for solenoid valve |
| 3 | 0 V for control unit |
| 4 | IO-Link communication |
| 5 | 0 V for solenoid valve |

Difference between IO-Link master port class A and class B

| Pin no. | IO-Link master port pin function | |
|---------|----------------------------------|-------------------------------|
| | Port class A | Port class B |
| 1 | +24 V | +24 V |
| 2 | NC/DI/DO | Additional power supply +24 V |
| 3 | 0 V | 0 V |
| 4 | IO-Link/DI/DO | IO-Link/DI/DO |
| 5 | NC | Additional power supply 0 V |

Y Branch Connector

Port class A compliant
A special wiring Y branch connector is available.



Used when connecting to a port class A type IO-Link master, which is often used when connecting to an IO-Link sensor

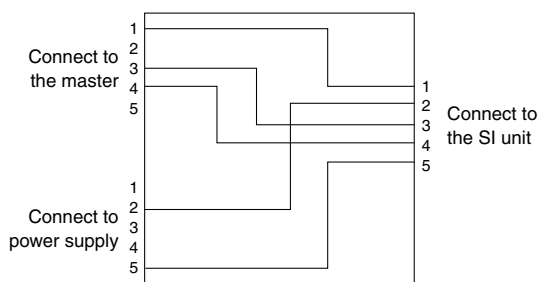

IO-Link compatible

Features an impressive self-diagnosis function

Self-diagnosis contents

| Diagnostic contents | Event category |
|--|----------------|
| Internal failure of the SI unit | Error |
| Output short circuit | Error |
| Output open circuit | Error |
| Solenoid valve power supply failure | Warning |
| Abnormal internal temperature of the SI unit | Warning |
| Output switching count value exceeded | Notification |

Real-time diagnosis (Process data)

- Any event information detected by the SI unit using the process data as the diagnostic input can be transmitted to the PLC and PC in real time via the master Fieldbus.
- 3 types of event flags are transmitted to the PLC. (Error/Warning/Notification)

Request base diagnosis (Service data)

- Regarding detailed diagnostic information, the event codes can be transmitted as service data to the PLC and PC.

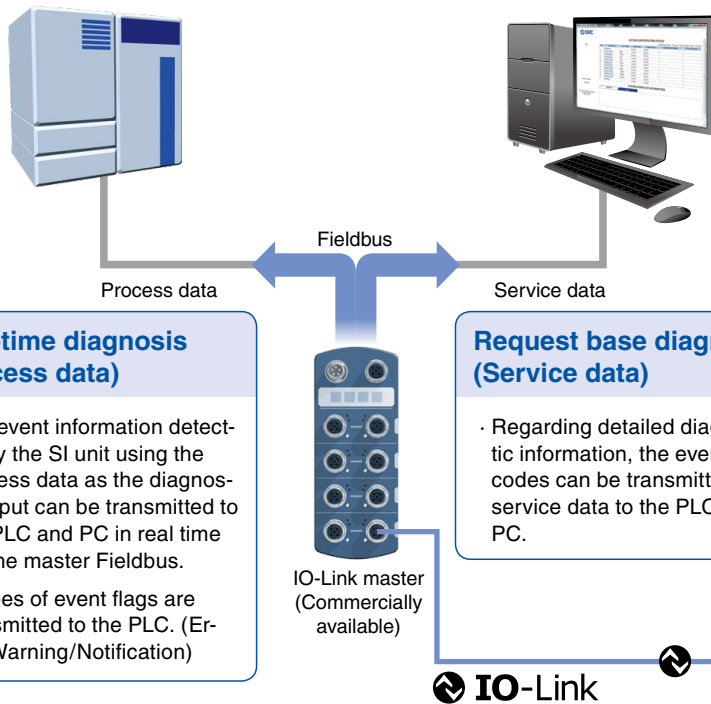

Equipped with a solenoid valve output operation count function

The number of valve operation instructions is counted for each output of the solenoid valve.

Set the count threshold value to be used as a guide for maintenance according to the operating conditions of the cylinder connected to the solenoid valve.



Once the threshold value is reached, notification of this fact will take place automatically.



This enables periodic maintenance to be performed before any unexpected cylinder failures occur.

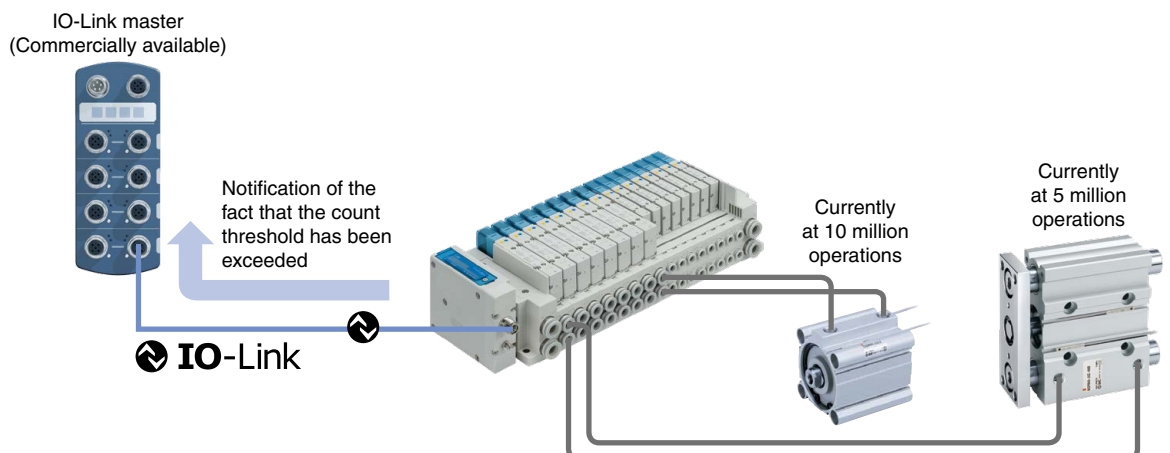

Supports safety communication (PROFIsafe) <EX260-FPS1>



PROFIsafe is established as an international standard (IEC 61784-3-3). It is a communication protocol that transmits safety-related data by PROFINET communication and can be used up until safety standards ISO 13849-1 PL e and IEC 61508/IEC 62061 SIL 3.

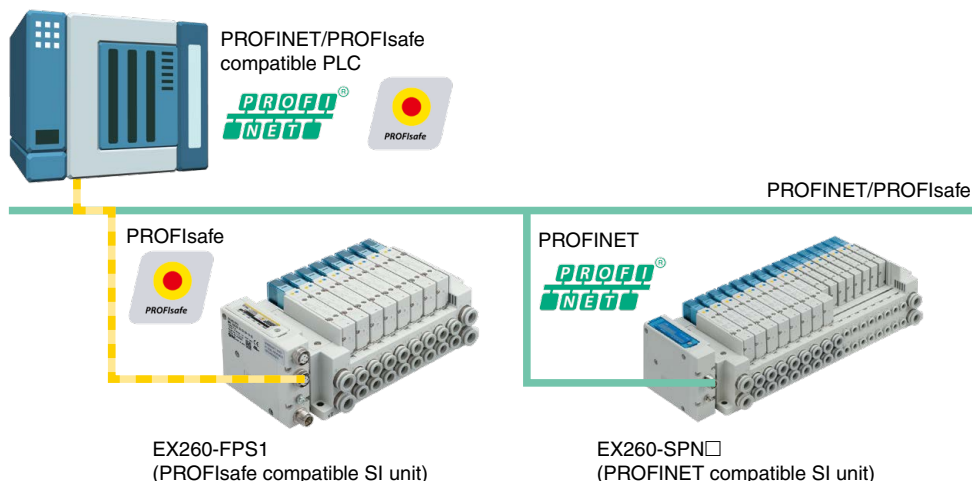

A PROFIsafe compatible PLC allows for the use of a PROFINET compatible SI unit and a PROFIsafe compatible SI unit to be used on one communication line at the same time.

Compliant with safety standards

This product (EX260-FPS1) is intended to facilitate safe machine and system designing (ISO/IEC standard compliance) and has been certified by a third party (TÜV Rheinland) for use up until the standards listed below.



IEC 61508/IEC 62061 SIL 3
ISO 13849 PL e/Cat. 3

· SIL (Safety Integrity Level)

A safety integrity level as defined by international standard IEC 61508/62061
There are 4 levels of safety, with the lowest being SIL 1 and the highest being SIL 4.

· PL (Performance Level)

A scale used to define the capability of safety-related parts to perform a safety function as defined by international standard ISO 13849
There are 5 levels of safety function, with the lowest being PL a and the highest being PL e.

Safety Output

This product (EX260-FPS1) has a safety switch inside the product. It shuts off the voltage supplied to the valve by turning OFF the safety switch via directive from the PLC to enter safe state. The safety switch of this product (EX260-FPS1) has two redundancies, one on the 24 V side and the other on the 0 V side. It continuously runs diagnostics. The safety switch is turned OFF in the event of an error detection.

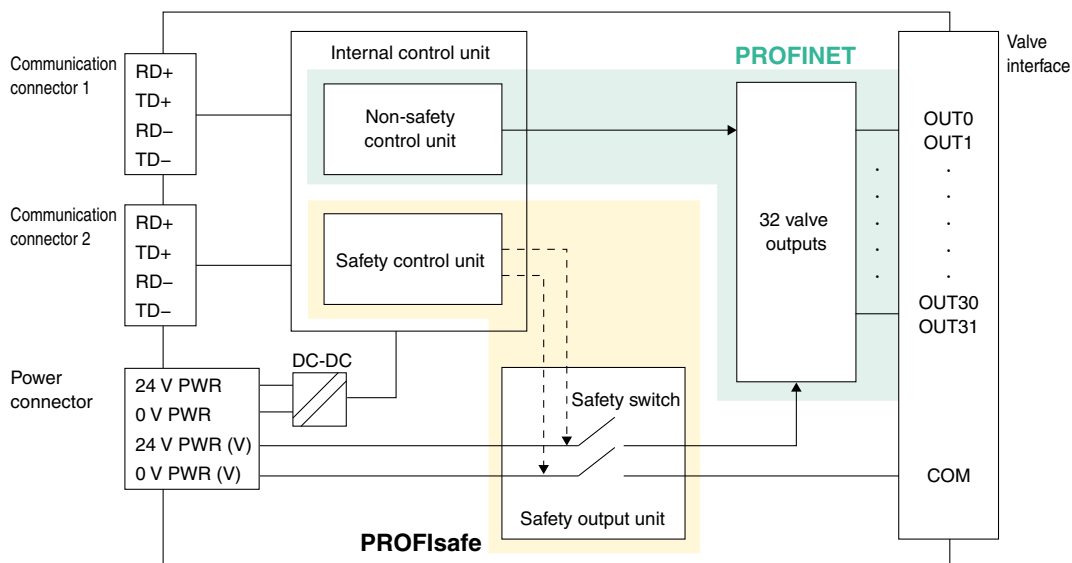

⚠ Safety Definition

The safe state of this product (EX260-FPS1) is a condition in which the safety output described above is turned OFF to shut off the supply of power to the valve manifold.
This product does not cover valve manifolds that are being used in connection with this product or the safety function and safe state of electric/air equipment that includes a peripheral circuit.

Reduced wiring, Space saving

For built-in safety output (EX260-FPS1)

- A separate safety output unit is not required. (Space saving)
- There is no need for wiring between the safety output unit and the EX260-FPS1. (Reduced wiring)

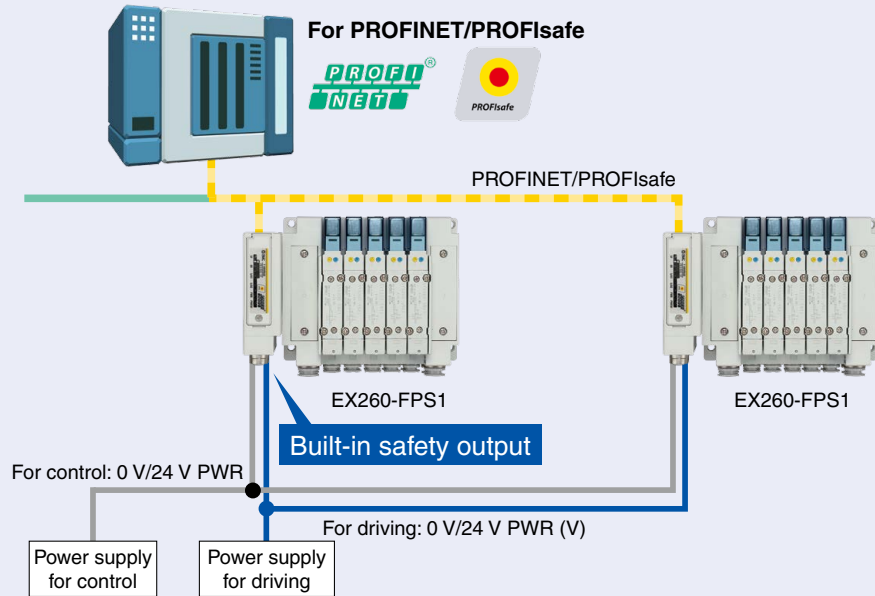

When a separate safety output unit is installed (Conventional connection example)

- A separate safety output unit is required. (Increased installation space)
- Increased wiring is required for connection with another unit. (Increased wiring)

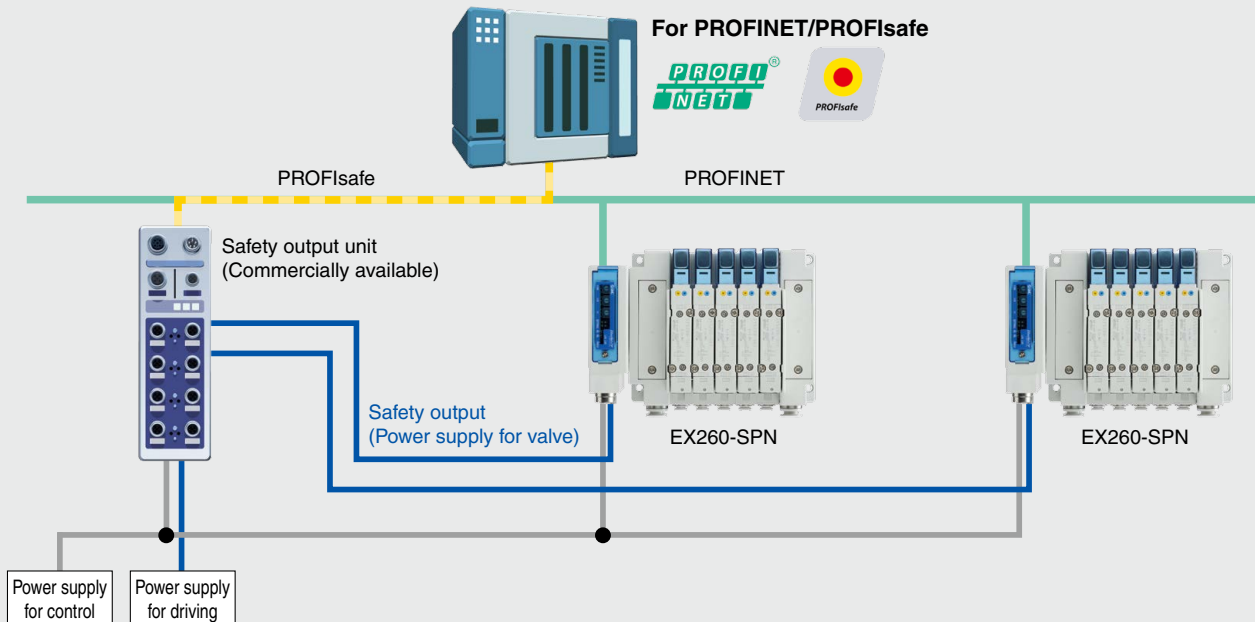

⚠ Safety of the machine or system

The manufacturer of the machine/system and its user are responsible for the safety of the machine/system. Use of this product (EX260-FPS1) requires machine/system safety concepts which are in accordance with the corresponding directives and standards, safety function validation, and hazard and risk analysis. Target SILs (IEC 61508/62061 compliance) and performance levels/categories (ISO 13849 compliance) are determined based on the risk analysis. For more information, refer to the "Safety of the machine or system" section in the operation manual of the EX260-FPS1.

CONTENTS

Fieldbus System (Output device for driving 5-port solenoid valves) **EX260 Series**

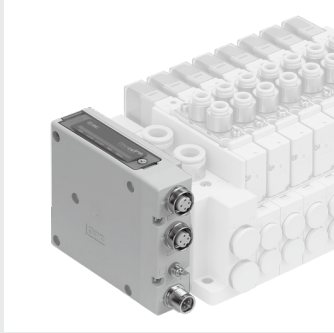

| | |
|------------------------------------|-------|
| How to Order SI Units | p. 9 |
| Specifications | p. 10 |
| Dimensions | p. 12 |
| Parts Description | p. 13 |
| LED Indicator | p. 14 |

Accessories

| | |
|--|-------|
| ① Communication Cable | p. 15 |
| ② Field-wireable Communication Connector | p. 21 |
| ③ Power Supply Cable (For SI unit) | p. 22 |
| ④ Power Supply Cable (For SI unit/For power block) ... | p. 23 |
| ⑤ Seal Cap (10 pcs.) | p. 23 |
| ⑥ Output Block | p. 24 |
| ⑦ Power Block | p. 24 |
| ⑧ Connector for Output Block Wiring | p. 25 |
| ⑨ End Plate | p. 25 |
| ⑩ Bracket Plate/DIN Rail Mounting Bracket | p. 25 |

Made to Order

| | |
|---|-------|
| SI Unit | |
| EtherNet/IP™ Web server function compatible | p. 26 |
| Communication Cable | p. 26 |
| Power Supply Cable | p. 27 |

| | |
|------------------------------------|-------|
| Specific Product Precautions | p. 28 |
|------------------------------------|-------|

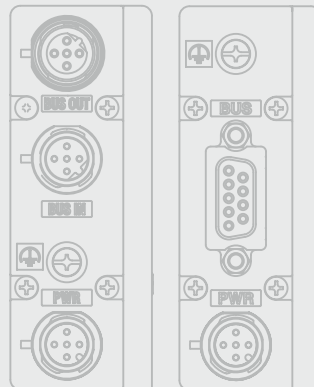
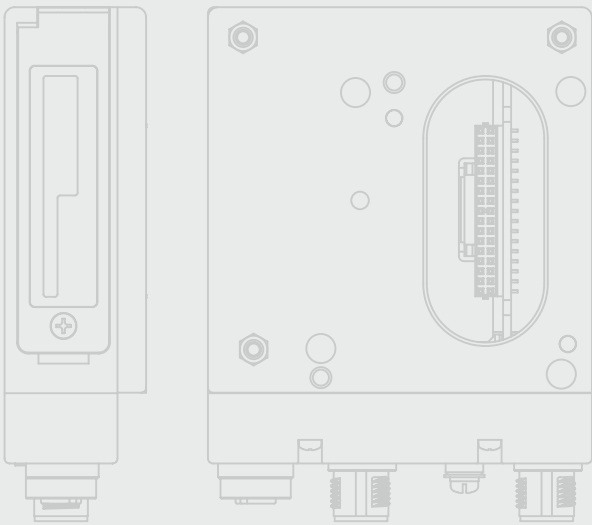

Fieldbus System For Output

EX260 Series



| | |
|--------------------------------------|--|
| Compact design | Compact design for space saving |
| Number of outputs | 32/16 digital output type available for each unit in the series (IO-Link and PROFI-safe are only compatible with the 32-point digital output type.) |
| Output polarity | Negative common (PNP)/positive common (NPN) type available for each unit in the series (Only negative common (PNP) is available for Ethernet POWERLINK, IO-Link, and PROFI-safe.) |
| Enclosure | IP67 (For units with a D-sub connector, and when connected with S0700 manifolds, it is IP40.) |
| Internal terminating resistor | ON/OFF switching is possible with an internal terminating resistor for communication. (Only for units compatible with M12 PROFIBUS DP, CC-Link communication connectors) |

Applicable Manifold

SY3000/5000/7000

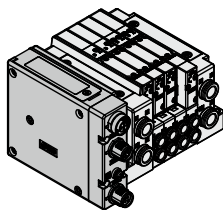

JSY1000/3000/5000

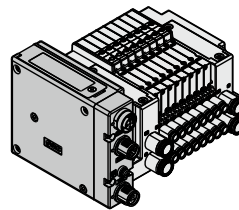

VQC1000/2000/4000/5000

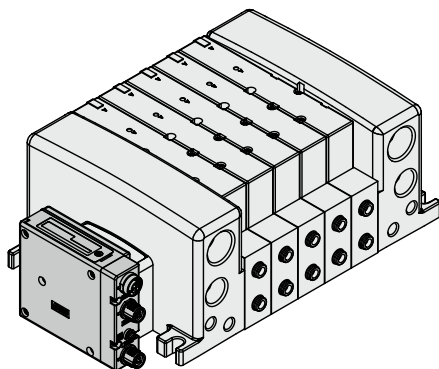

S0700

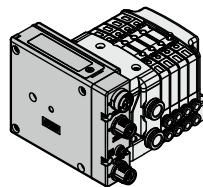

SV1000/2000/3000

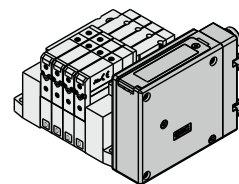

How to Order SI Units

EX260 - S PR1

Communication protocol

| Symbol | Protocol | Number of outputs | Output polarity | Communication connector | Manifold symbol | Applicable manifold | |
|--------|--------------------|-------------------|------------------------------|-------------------------|------------------------------|--|-----|
| DN1 | DeviceNet™ | 32 | Source/PNP (Negative common) | M12 | QAN | SY3000/5000/7000 JSY1000/3000/5000 VQC1000/2000/4000/5000 S0700 SV1000/2000/3000 | |
| DN2 | | | Sink/NPN (Positive common) | | QA | | |
| DN3 | | 16 | Source/PNP (Negative common) | | QBN | | |
| DN4 | | | Sink/NPN (Positive common) | | QB | | |
| PR1 | PROFIBUS DP | 32 | Source/PNP (Negative common) | M12 | NAN | | |
| PR2 | | | Sink/NPN (Positive common) | | NA | | |
| PR3 | | 16 | Source/PNP (Negative common) | | NBN | | |
| PR4 | | | Sink/NPN (Positive common) | | NB | | |
| PR5 | | D-sub*1 | 32 | | Source/PNP (Negative common) | | NCN |
| PR6 | | | Sink/NPN (Positive common) | | NC | | |
| PR7 | | | 16 | | Source/PNP (Negative common) | | NDN |
| PR8 | | | | | Sink/NPN (Positive common) | | ND |
| MJ1 | CC-Link | 32 | Source/PNP (Negative common) | M12 | VAN | | |
| MJ2 | | | Sink/NPN (Positive common) | | VA | | |
| MJ3 | | 16 | Source/PNP (Negative common) | | VBN | | |
| MJ4 | | | Sink/NPN (Positive common) | | VB | | |
| EC1 | EtherCAT | 32 | Source/PNP (Negative common) | M12 | DAN | | |
| EC2 | | | Sink/NPN (Positive common) | | DA | | |
| EC3 | | 16 | Source/PNP (Negative common) | | DBN | | |
| EC4 | | | Sink/NPN (Positive common) | | DB | | |
| PN1 | PROFINET | 32 | Source/PNP (Negative common) | M12 | FAN | | |
| PN2 | | | Sink/NPN (Positive common) | | FA | | |
| PN3 | | 16 | Source/PNP (Negative common) | | FBN | | |
| PN4 | | | Sink/NPN (Positive common) | | FB | | |
| EN1 | EtherNet/IP™ | 32 | Source/PNP (Negative common) | M12 | EAN | | |
| EN2 | | | Sink/NPN (Positive common) | | EA | | |
| EN3 | | 16 | Source/PNP (Negative common) | | EBN | | |
| EN4 | | | Sink/NPN (Positive common) | | EB | | |
| PL1 | Ethernet POWERLINK | 32 | Source/PNP (Negative common) | M12 | GAN | | |
| PL3 | | 16 | | | GBN | | |
| IL1 | IO-Link | 32 | Source/PNP (Negative common) | M12 | KAN | SY3000/5000/7000 JSY1000/3000/5000 VQC1000/2000/4000/5000 | |

*1 Enclosure is IP40 when the communication connector is D-sub.



Made to Order

→ p. 26

EtherNet/IP™ Web server function compatible

* For "How to Order Manifold Assembly," refer to the **Web Catalog** of each valve.

Safety communication compliant SI unit

EX260 - F PS1

Communication protocol

| Symbol | Protocol | Number of outputs | Output polarity | Communication connector | Manifold symbol | Applicable manifold |
|--------|-----------|-------------------|------------------------------|-------------------------|-----------------|---|
| PS1 | PROFIsafe | 32 | Source/PNP (Negative common) | M12 | FPN | SY3000/5000/7000 JSY1000/3000/5000 VQC1000/2000/4000/5000 |

* The use of validated products may be required for valve manifolds used in the safety-related parts of equipment which is compliant with safety standard ISO 13849. For validated products, please contact your SMC sales representative.

Specifications

All SI Units Common Specifications

| | | |
|--------------------------|-------------------------------------|--|
| Power supply for control | Power supply voltage | 21.6 to 26.4 VDC*1 |
| | Internal current consumption | 100 mA or less*4 |
| Power supply for output | Power supply voltage | 22.8 to 26.4 VDC |
| | Enclosure | IP67*2 |
| Environmental resistance | Operating temperature range | -10 to +50°C |
| | Operating humidity range | 35 to 85% RH (No condensation) |
| | Withstand voltage | 500 VAC for 1 minute between terminals and housing |
| | Insulation resistance | 10 MΩ or more (500 VDC measured via megohmmeter) between terminals and housing |
| Standards | | CE marking (EMC directive/RoHS directive), UL (CSA) compliant |
| Weight | | 200 g |
| Accessories | Mounting screw | 2 pcs. |
| | Seal cap (for M12 connector socket) | EX9-AWTS (1 pc.)*3 |

*1 To serve as the power supply for communication, the power supply voltages are 11 to 25 VDC for the EX260-SDN□, 18 to 30 VDC for the EX260-SIL1, and 20.4 to 28.8 VDC for the EX260-FPS1.

*2 IP40 applies to EX260-SPR5/6/7/8.

*3 Not provided for EX260-SPR5/6/7/8

*4 200 mA or less for the EX260-FPS1

| Model | EX260-SPR1/3 | EX260-SPR2/4 | EX260-SPR5/7 | EX260-SPR6/8 | EX260-SDN1/3 | EX260-SDN2/4 |
|---------------------------------------|--|--|--------------------------------------|--------------------------------------|--|--|
| Applicable system | Protocol | | | | DeviceNet™ | |
| | Version*1 | | | | Volume 1 (Edition 3.5) Volume 3 (Edition 1.5) | |
| | Configuration file*3 | | | | EDS file | |
| I/O occupation area (Inputs/Outputs) | SPR1: 0/32 SPR3: 0/16 | SPR2: 0/32 SPR4: 0/16 | SPR5: 0/32 SPR7: 0/16 | SPR6: 0/32 SPR8: 0/16 | SDN1: 0/32 SDN3: 0/16 | SDN2: 0/32 SDN4: 0/16 |
| Applicable function | — | | | | QuickConnect™ | |
| Communication speed | 9.6 k/19.2 k/45.45 k/93.75 k/187.5 k/500 k/1.5 M/3 M/6 M/12 Mbps | | | | 125 k/250 k/500 kbps | |
| Communication connector specification | M12 | | | D-sub*4 | | M12 |
| Terminating resistor switch | Built-in | | | None | | |
| Output | Output type | Source/PNP (Negative common) | Sink/NPN (Positive common) | Source/PNP (Negative common) | Sink/NPN (Positive common) | Sink/NPN (Positive common) |
| | Number of outputs | SPR1: 32 points SPR3: 16 points | SPR2: 32 points SPR4: 16 points | SPR5: 32 points SPR7: 16 points | SPR6: 32 points SPR8: 16 points | SDN1: 32 points SDN3: 16 points SDN2: 32 points SDN4: 16 points |
| | Load | Solenoid valve with surge voltage suppressor 24 VDC, 1.5 W or less (SMC) | | | | |
| | Supplied voltage | 24 VDC | | | | |
| | Supplied current | SPR1: Max. 2.0 A SPR3: Max. 1.0 A | SPR2: Max. 2.0 A SPR4: Max. 1.0 A | SPR5: Max. 2.0 A SPR7: Max. 1.0 A | SPR6: Max. 2.0 A SPR8: Max. 1.0 A | SDN1: Max. 2.0 A SDN3: Max. 1.0 A |

| Model | EX260-SMJ1/3 | EX260-SMJ2/4 | EX260-SEC1/3 | EX260-SEC2/4 | EX260-SPN1/3 | EX260-SPN2/4 | |
|---------------------------------------|--|--|--------------------------------------|--------------------------------------|--------------------------------------|--|--------------------------------------|
| Applicable system | Protocol | | CC-Link | | EtherCAT*2 | | |
| | Version*1 | | Ver. 1.10 | | PROFINET*2 | | |
| | Configuration file*3 | | CSP+ file | | XML file | | |
| I/O occupation area (Inputs/Outputs) | SMJ1: 32/32 SMJ3: 32/32 (1 station, remote I/O stations) | SMJ2: 32/32 SMJ4: 32/32 (1 station, remote I/O stations) | SEC1: 0/32 SEC3: 0/16 | SEC2: 0/32 SEC4: 0/16 | SPN1: 0/32 SPN3: 0/16 | SPN2: 0/32 SPN4: 0/16 | |
| Applicable function | — | | | | FSU, MRP | | |
| Communication speed | 156 k/625 k/2.5 M/5 M/10 Mbps | | | 100 Mbps*2 | | | |
| Communication connector specification | M12 | | | | | | |
| Terminating resistor switch | Built-in | | | None (Not required) | | | |
| Output | Output type | Source/PNP (Negative common) | Sink/NPN (Positive common) | Source/PNP (Negative common) | Sink/NPN (Positive common) | Sink/NPN (Positive common) | |
| | Number of outputs | SMJ1: 32 points SMJ3: 16 points | SMJ2: 32 points SMJ4: 16 points | SEC1: 32 points SEC3: 16 points | SEC2: 32 points SEC4: 16 points | SPN1: 32 points SPN3: 16 points SPN2: 32 points SPN4: 16 points | |
| | Load | Solenoid valve with surge voltage suppressor 24 VDC, 1.5 W or less (SMC) | | | | Solenoid valve with surge voltage suppressor 24 VDC, 1.0 W or less (SMC) | |
| | Supplied voltage | 24 VDC | | | | | |
| | Supplied current | SMJ1: Max. 2.0 A SMJ3: Max. 1.0 A | SMJ2: Max. 2.0 A SMJ4: Max. 1.0 A | SEC1: Max. 2.0 A SEC3: Max. 1.0 A | SEC2: Max. 2.0 A SEC4: Max. 1.0 A | SPN1: Max. 2.0 A SPN3: Max. 1.0 A | SPN2: Max. 2.0 A SPN4: Max. 1.0 A |

*1 Please note that the version is subject to change.

*2 Use a CAT5 or higher communication cable for EtherCAT, PROFINET, Ethernet/IP™, and Ethernet POWERLINK.

*3 The configuration file can be downloaded from the SMC website: <https://www.smcworld.com>

*4 Enclosure is IP40 when the communication connector is D-sub.

EX260 Series

Specifications

| Model | | EX260-SEN1/3 | EX260-SEN2/4 | EX260-SPL1 | EX260-SPL3 | EX260-SIL1 | EX260-FPS1 |
|---------------------------------------|----------------------|---|--------------------------------------|---------------------------------|------------|-----------------|--|
| Applicable system | Protocol | EtherNet/IP™*2 | | Ethernet POWERLINK | | IO-Link | PROFINET/ PROFIsafe*2 |
| | Version*1 | Volume 1 (Edition 3.17) Volume 2 (Edition 1.18) | | EPG DS 301 Version 1.2.0 | | V1.1 | PROFINET Specification Version 2.3 PROFIsafe Specification Version 2.4 |
| | Configuration file*3 | EDS file | | XDD file | | IODD file | GSD file |
| I/O occupation area (Inputs/Outputs) | | SEN1: 16/32 SEN3: 16/16 | SEN2: 16/32 SEN4: 16/16 | 16/32 | 16/16 | 0/32 16/32*4 | 0/32*5 |
| Applicable function | | QuickConnect™, DLR | | — | | — | FSU, Shared Device, MRP |
| Communication speed | | 10 M/100 Mbps*2 | | 100 Mbps*2 | | COM3/COM2*4 | 100 Mbps*2 |
| Communication connector specification | | M12 | | | | | |
| Terminating resistor switch | | None (Not required) | | | | | |
| Output | Output type | Source/PNP (Negative common) | Sink/NPN (Positive common) | Source/PNP (Negative common) | | | |
| | Number of outputs | SEN1: 32 points SEN3: 16 points | SEN2: 32 points SEN4: 16 points | 32 | 16 | 32 | |
| | Load | Solenoid valve with surge voltage suppressor 24 VDC, 1.5 W or less (SMC) | | | | | Solenoid valve with surge voltage suppressor 24 VDC, 0.95 W or less (SMC) |
| | Supplied voltage | 24 VDC | | | | | |
| | Supplied current | SEN1: Max. 2.0 A SEN3: Max. 1.0 A | SEN2: Max. 2.0 A SEN4: Max. 1.0 A | Max. 2 A | Max. 1 A | Max. 2 A | Max. 1.3 A |

*1 Please note that the version is subject to change.

*2 Use a CAT5 or higher communication cable for PROFINET, PROFIsafe, EtherNet/IP™, and Ethernet POWERLINK.

*3 The configuration file can be downloaded from the SMC website: <https://www.smcworld.com>

*4 A selection can be made using the setting switch.

*5 In addition, it occupies input 4 bite/output 5 bite for safety.

Dimensions

M12 communication connector type

- For PROFIBUS DP For DeviceNet™
- For CC-Link For EtherCAT For PROFINET
- For EtherNet/IP™ For Ethernet POWERLINK

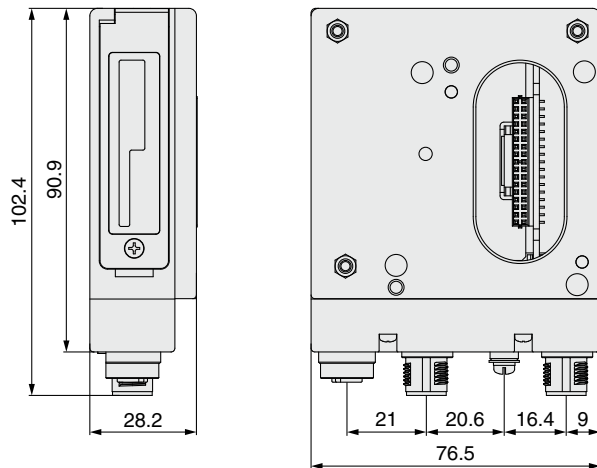

D-sub communication connector type
(EX260-SPR5/6/7/8)

- For PROFIBUS DP

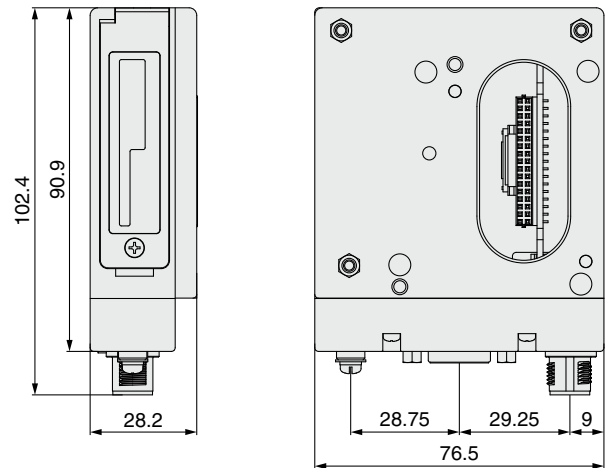

M12 communication connector type

- For IO-Link

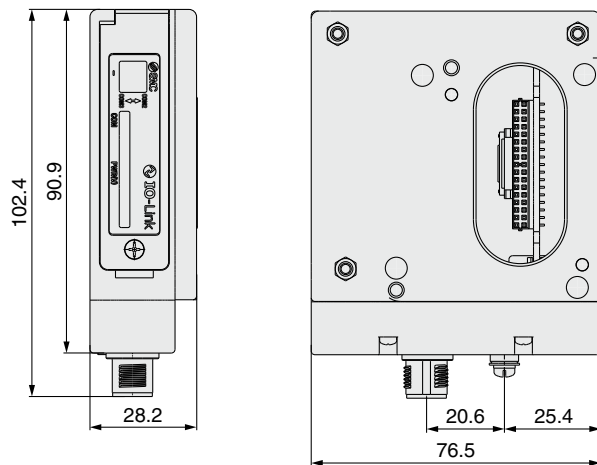

M12 communication connector type

- For PROFI-safe

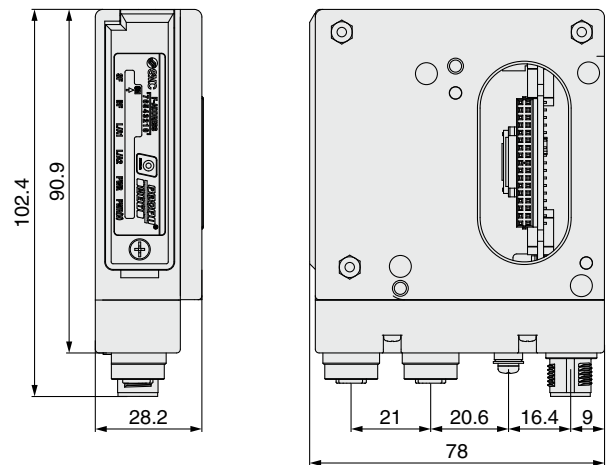

EX260 Series

Parts Description

For PROFIBUS DP For DeviceNet™ For CC-Link

For PROFIsafe For EtherCAT For PROFINET

For EtherNet/IP™ For Ethernet POWERLINK

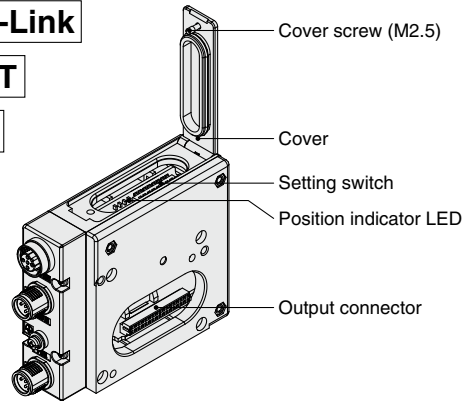

* The setting switch varies depending on the model. Refer to the operation manual for details. It can be downloaded via the SMC website: <https://www.smcworld.com>

<Connector> M12 communication connector type

| Part no. | EX260-SPR1/-SPR2 -SPR3/-SPR4 | EX260-SDN□ | EX260-SMJ□ | EX260-SEC□ EX260-SPN□ EX260-SEN□ EX260-SPL□ EX260-FPS1 |
|---------------------------------------|-----------------------------------|-----------------------------------|---|---|
| Communication protocol | PROFIBUS DP | DeviceNet™ | CC-Link | EtherCAT PROFINET EtherNet/IP™ EtherNet POWERLINK PROFIsafe |
| Communication connector (M12) BUS OUT | 5 pins, socket, B code (SPEEDCON) | 5 pins, socket, A code (SPEEDCON) | 5 pins, socket, A code* ¹ (SPEEDCON) | 4 pins, socket, D code (SPEEDCON) |
| Communication connector (M12) BUS IN | 5 pins, plug, B code (SPEEDCON) | 5 pins, plug, A code (SPEEDCON) | 4 pins, plug, A code (SPEEDCON) | 4 pins, socket, D code (SPEEDCON) |
| Ground terminal | M3 | | | |
| Power connector (M12) | 5 pins, plug, A code (SPEEDCON) | 4 pins, plug, A code (SPEEDCON) | 5 pins, plug, B code (SPEEDCON) | 5 pins* ² , 4 pins* ³ , plug, A code (SPEEDCON) |

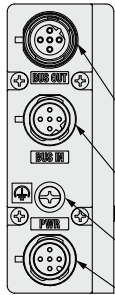

*¹ Recommended mating M12 4-pin plug part no.: PCA-1567717
*² For EtherCAT, PROFINET, and Ethernet POWERLINK
*³ For EtherNet/IP™ and PROFIsafe

<Connector> D-sub communication connector type

| Part no. | EX260-SPR5/-SPR6/-SPR7/-SPR8 |
|--|------------------------------|
| Communication protocol | PROFIBUS DP |
| Ground terminal | M3 |
| Communication connector (D-sub) BUS IN/OUT | 9 pins, socket |
| Power connector (M12) | 5 pins, plug, A code |

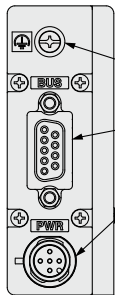

For IO-Link

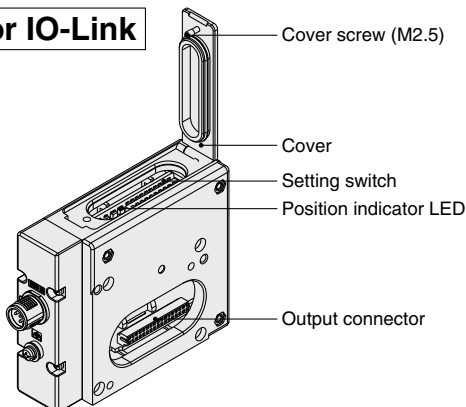

<Connector>

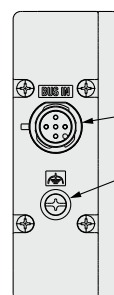

| Part no. | EX260-SIL1 |
|-------------------------------------|--|
| Communication protocol | IO-Link |
| Communication/Power connector (M12) | 5 pins, plug,* ¹ A code (SPEEDCON) |
| Ground terminal | M3 |

*¹ The communication line, SI unit power supply line, and the solenoid valve power supply line are connected using the same cable.

* The setting switch varies depending on the model. Refer to the operation manual for details. It can be downloaded via the SMC website: <https://www.smcworld.com>

LED Indicator

For DeviceNet™ EX260-SDN□

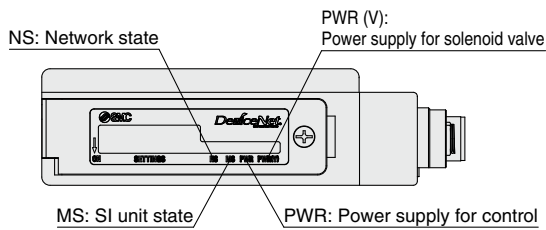

For EtherCAT EX260-SEC□

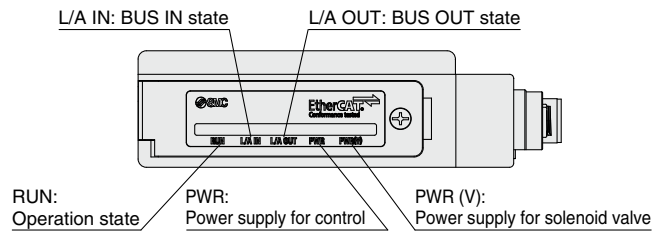

For EtherNet/IP™ EX260-SEN□

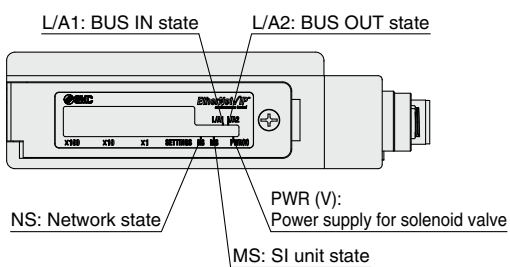

For CC-Link EX260-SMJ□

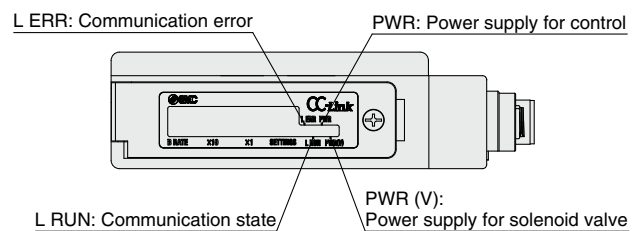

For PROFINET EX260-SPN□

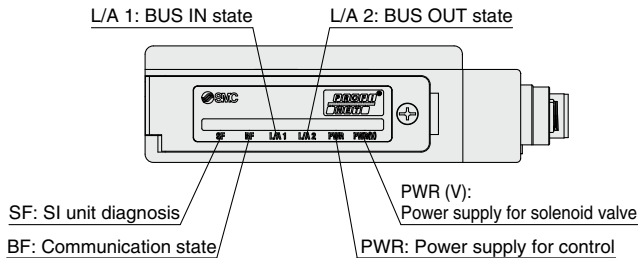

For PROFIBUS DP EX260-SPR□

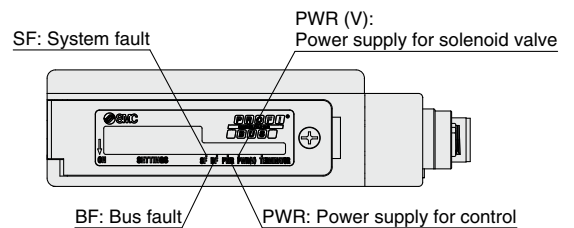

For Ethernet POWERLINK EX260-SPL□

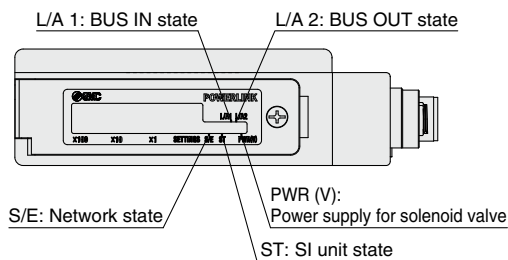

For IO-Link EX260-SIL1

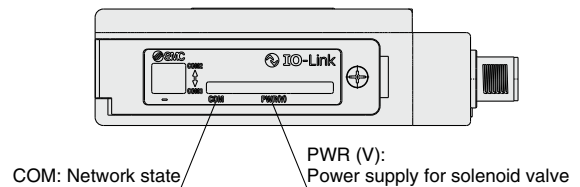

For PROFIsafe EX260-FPS1

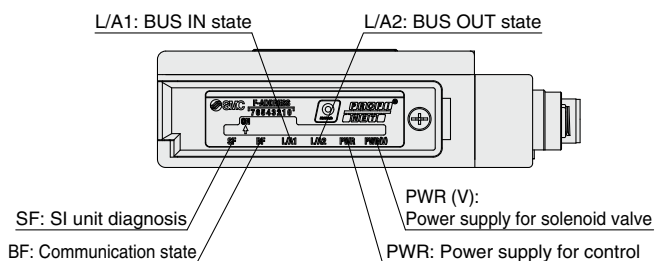

EX260 Series Accessories

① Communication Cable

For CC-Link

PCA-1567720
(Socket)

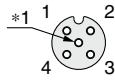

Socket connector pin arrangement
A-coded (Normal key)

*1 Number of holes: 5,
Total number of pins: 4

PCA-1567717
(Plug)



Plug connector pin arrangement
A-coded (Normal key)

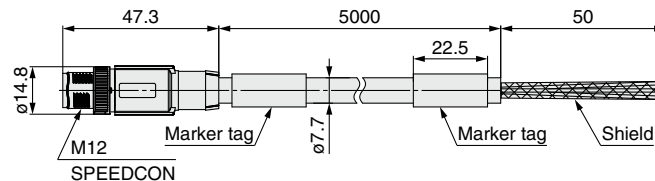
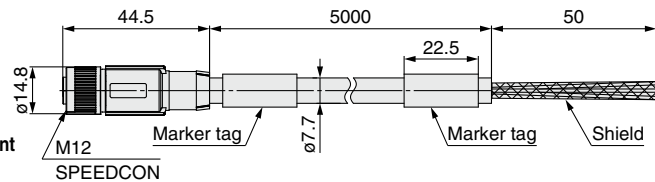

Made to Order

| | | |
|--------------|----------|-------|
| Cable length | 10000 mm | p. 26 |
|--------------|----------|-------|

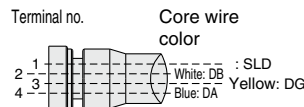

Connections

| Item | | Specifications |
|---------------------------------|-----------|-----------------------------|
| Cable O.D. | | ø7.7 mm |
| Conductor nominal cross section | Data pair | 0.5 mm ² /AWG20 |
| | Drain | 0.34 mm ² /AWG22 |
| Wire O.D. (Including insulator) | | 2.55 mm |
| Min. bending radius (Fixed) | | 77 mm |

EX9-AC 005 MJ-SSPS (With connector on both sides (Socket/Plug))

• Cable length (L)

| | |
|-----|----------|
| 005 | 500 mm |
| 010 | 1000 mm |
| 020 | 2000 mm |
| 030 | 3000 mm |
| 050 | 5000 mm |
| 100 | 10000 mm |

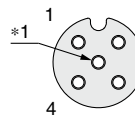
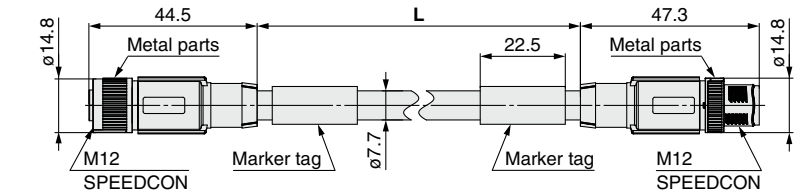

Socket connector pin arrangement
A-coded (Normal key)

*1 Number of holes: 5,
Total number of pins: 4

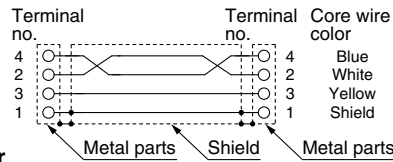

Connections

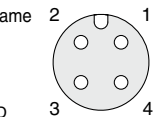

Plug connector pin arrangement
A-coded (Normal key)

| Item | | Specifications |
|---------------------------------|-----------|-----------------------------|
| Cable O.D. | | ø7.7 mm |
| Conductor nominal cross section | Data pair | 0.5 mm ² /AWG20 |
| | Drain | 0.34 mm ² /AWG22 |
| Wire O.D. (Including insulator) | | 2.55 mm |
| Min. bending radius (Fixed) | | 77 mm |

EX9-AC 005 MJ-SAPA (With angled connector on both sides (Socket/Plug))

• Cable length (L)

| | |
|-----|----------|
| 005 | 500 mm |
| 010 | 1000 mm |
| 020 | 2000 mm |
| 030 | 3000 mm |
| 050 | 5000 mm |
| 100 | 10000 mm |

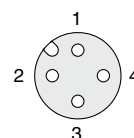
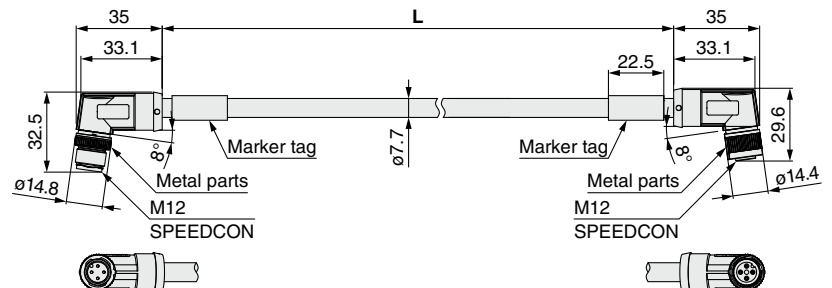

Plug connector pin arrangement
A-coded (Normal key)

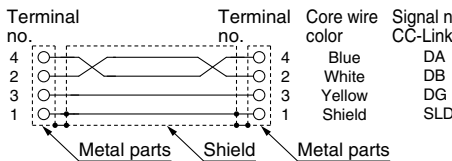

Connections

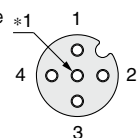

Socket connector pin arrangement
A-coded (Normal key)

*1 Number of holes: 5,
Total number of pins: 4

| Item | | Specifications |
|---------------------------------|-----------|-----------------------------|
| Cable O.D. | | ø7.7 mm |
| Conductor nominal cross section | Data pair | 0.5 mm ² /AWG20 |
| | Drain | 0.34 mm ² /AWG22 |
| Wire O.D. (Including insulator) | | 2.55 mm |
| Min. bending radius (Fixed) | | 77 mm |

1 Communication Cable

For DeviceNet™

PCA-1557633
(Socket)

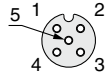

Socket connector pin arrangement A-coded (Normal key)

PCA-1557646
(Plug)

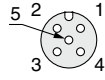

Plug connector pin arrangement A-coded (Normal key)

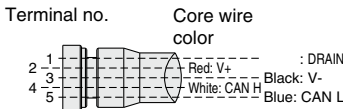
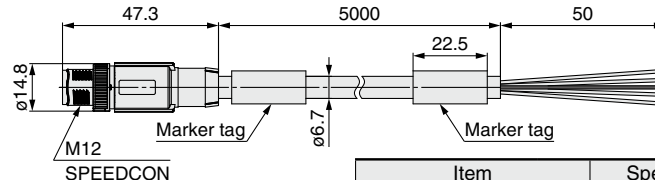
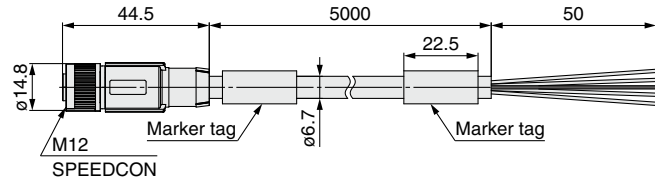

Connections

| Item | | Specifications |
|--|------------|-----------------------------|
| Cable O.D. | | ø6.7 mm |
| Conductor nominal cross section | Power pair | 0.34 mm ² /AWG22 |
| | Data pair | 0.25 mm ² /AWG24 |
| Wire O.D. (Including insulator) | Power pair | 1.4 mm |
| | Data pair | 2.05 mm |
| Min. bending radius (Fixed) | | 67 mm |



Made to Order

| | | |
|--------------|----------|-------|
| Cable length | 10000 mm | p. 26 |
|--------------|----------|-------|

EX9-AC 005 DN-SSPS (With connector on both sides (Socket/Plug))

• Cable length (L)

| | |
|------------|----------|
| 005 | 500 mm |
| 010 | 1000 mm |
| 020 | 2000 mm |
| 030 | 3000 mm |
| 050 | 5000 mm |
| 100 | 10000 mm |

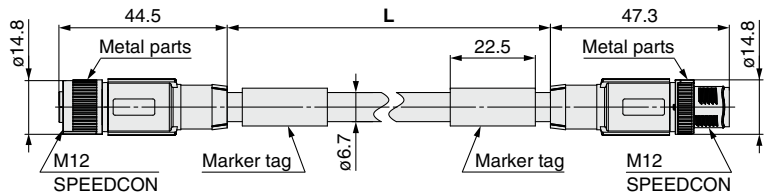

| Item | | Specifications |
|--|------------|-----------------------------|
| Cable O.D. | | ø6.7 mm |
| Conductor nominal cross section | Power pair | 0.34 mm ² /AWG22 |
| | Data pair | 0.25 mm ² /AWG24 |
| Wire O.D. (Including insulator) | Power pair | 1.4 mm |
| | Data pair | 2.05 mm |
| Min. bending radius (Fixed) | | 67 mm |

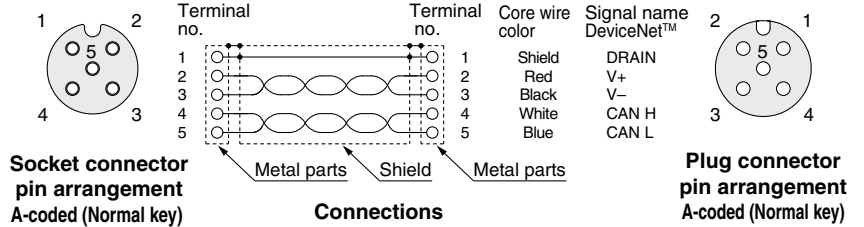

EX9-AC 005 DN-SAPA (With angled connector on both sides (Socket/Plug))

• Cable length (L)

| | |
|------------|----------|
| 005 | 500 mm |
| 010 | 1000 mm |
| 020 | 2000 mm |
| 030 | 3000 mm |
| 050 | 5000 mm |
| 100 | 10000 mm |

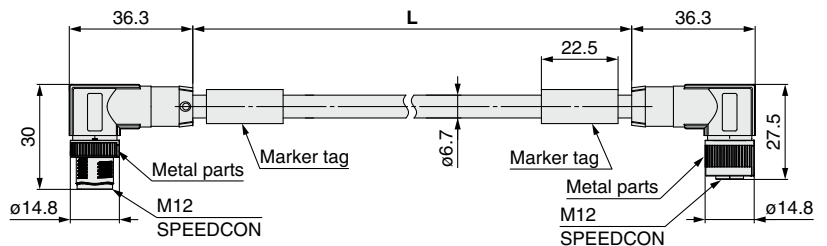

| Item | | Specifications |
|--|------------|-----------------------------|
| Cable O.D. | | ø6.7 mm |
| Conductor nominal cross section | Power pair | 0.34 mm ² /AWG22 |
| | Data pair | 0.25 mm ² /AWG24 |
| Wire O.D. (Including insulator) | Power pair | 1.4 mm |
| | Data pair | 2.05 mm |
| Min. bending radius (Fixed) | | 67 mm |

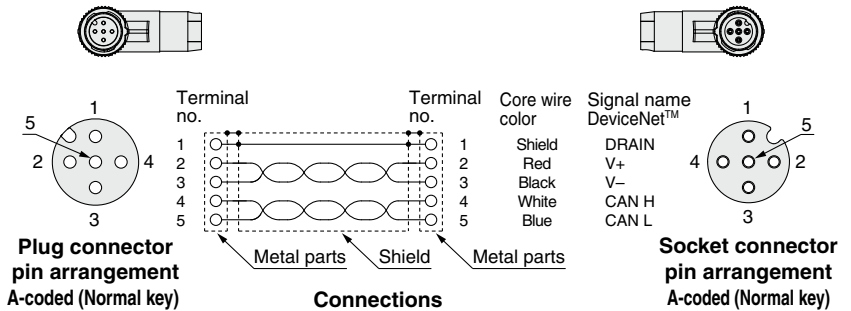

EX260 Series

① Communication Cable

For PROFIBUS DP

PCA-1557688
(Socket)

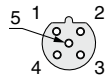

Socket connector pin arrangement B-coded (Reverse key)

PCA-1557691
(Plug)

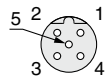

Plug connector pin arrangement B-coded (Reverse key)

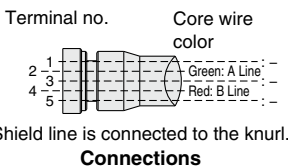
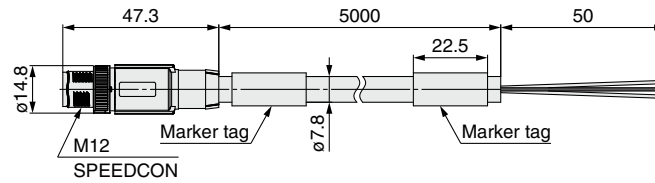
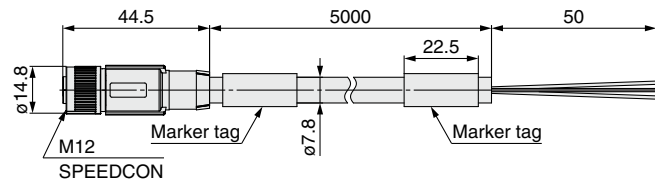

| Item | Specifications |
|--|-----------------------------|
| Cable O.D. | ø7.8 mm |
| Conductor nominal cross section | 0.34 mm ² /AWG22 |
| Wire O.D. (Including insulator) | 2.55 mm |
| Min. bending radius (Fixed) | 78 mm |

For EtherCAT

For PROFINET

For EtherNet/IP™

For Ethernet POWERLINK

For PROFIsafe

EX9-AC 020 EN-PSRJ (Plug/RJ-45 connector)

• Cable length (L)

| | |
|------------|----------|
| 010 | 1000 mm |
| 020 | 2000 mm |
| 030 | 3000 mm |
| 050 | 5000 mm |
| 100 | 10000 mm |

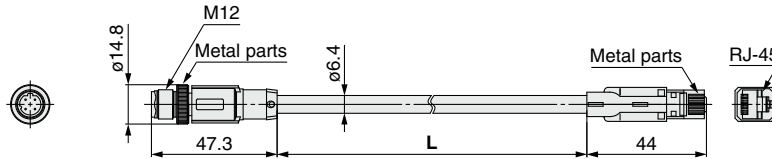

Plug connector pin arrangement D-coded

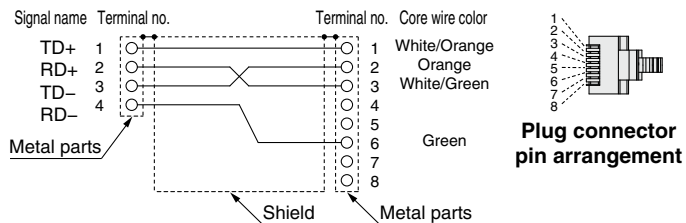

Connections (Straight cable)

| Item | Specifications |
|--|-----------------------------|
| Cable O.D. | ø6.4 mm |
| Conductor nominal cross section | 0.14 mm ² /AWG26 |
| Wire O.D. (Including insulator) | 0.98 mm |
| Min. bending radius (Fixed) | 26 mm |

PCA-1446566 (Plug)



Plug connector pin arrangement D-coded

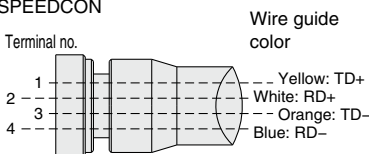
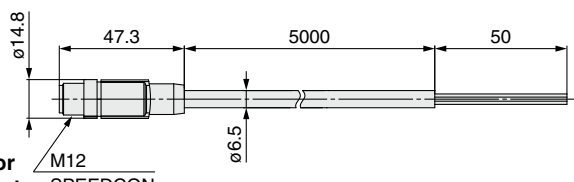

Connections

| Item | Specifications |
|--|-----------------------------|
| Cable O.D. | ø6.5 mm |
| Conductor nominal cross section | 0.34 mm ² /AWG22 |
| Wire O.D. (Including insulator) | 1.55 mm |
| Min. bending radius (Fixed) | 19.5 mm |

① Communication Cable

For EtherCAT

For PROFINET

For EtherNet/IP™

For Ethernet POWERLINK

For PROFIsafe

EX9-AC 005 EN-PSPS (With connector on both sides (Plug/Plug))

• Cable length (L)

| | |
|-----|----------|
| 005 | 500 mm |
| 010 | 1000 mm |
| 020 | 2000 mm |
| 030 | 3000 mm |
| 050 | 5000 mm |
| 100 | 10000 mm |

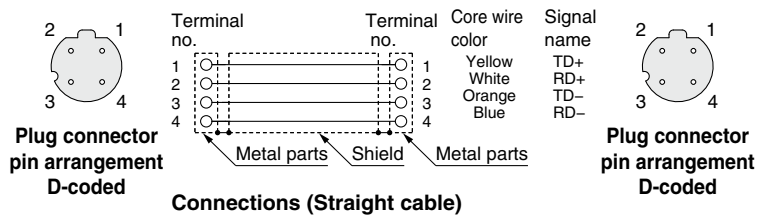
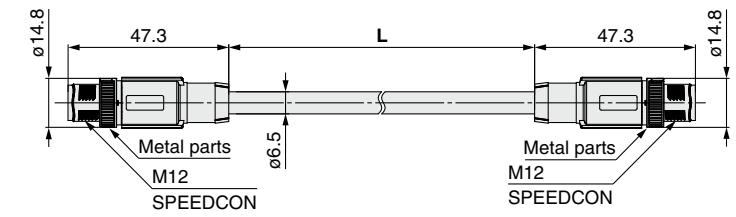

Connections (Straight cable)

| Item | Specifications |
|--|-----------------------------|
| Cable O.D. | ø6.5 mm |
| Conductor nominal cross section | 0.34 mm ² /AWG22 |
| Wire O.D. (Including insulator) | 1.55 mm |
| Min. bending radius (Fixed) | 19.5 mm |

EX9-AC 005 EN-PAPA (With angled connector on both sides (Plug/Plug))

• Cable length (L)

| | |
|-----|----------|
| 005 | 500 mm |
| 010 | 1000 mm |
| 020 | 2000 mm |
| 030 | 3000 mm |
| 050 | 5000 mm |
| 100 | 10000 mm |

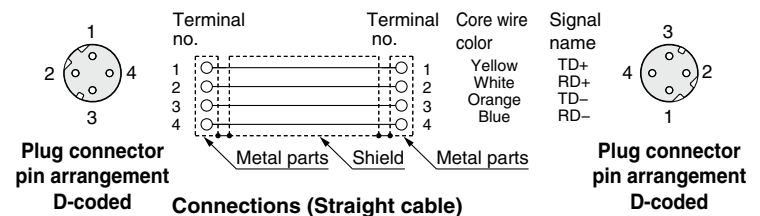
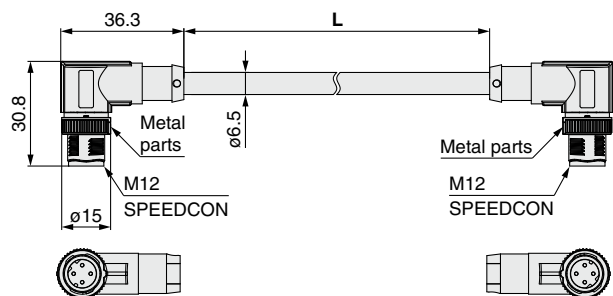

Connections (Straight cable)

| Item | Specifications |
|--|-----------------------------|
| Cable O.D. | ø6.5 mm |
| Conductor nominal cross section | 0.34 mm ² /AWG22 |
| Wire O.D. (Including insulator) | 1.55 mm |
| Min. bending radius (Fixed) | 19.5 mm |

EX260 Series

① Communication Cable

For IO-Link

Connection examples

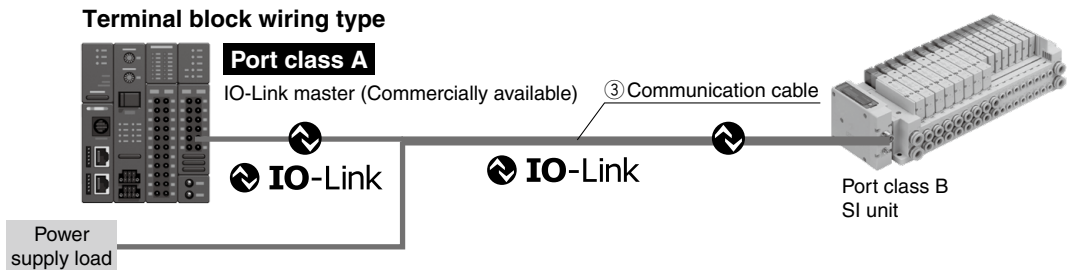
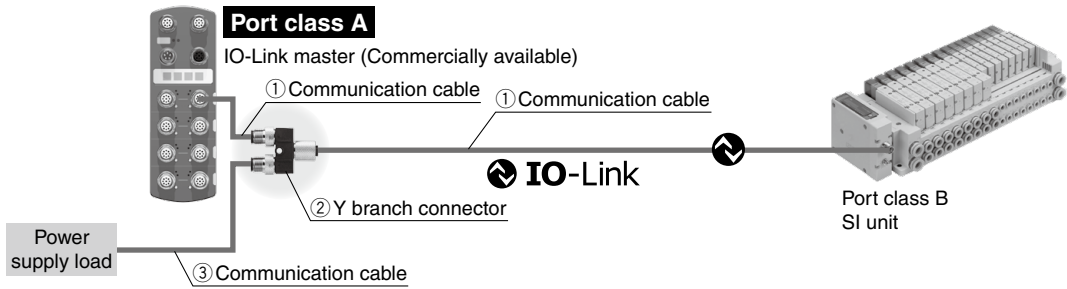
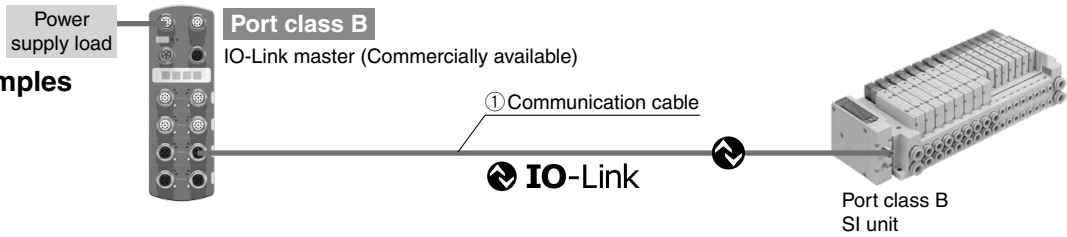

① Communication cable

EX9-AC 005 -SSPS (With connector on both sides (Socket/Plug))

• Cable length (L)

| | |
|-----|----------|
| 005 | 500 mm |
| 010 | 1000 mm |
| 020 | 2000 mm |
| 030 | 3000 mm |
| 050 | 5000 mm |
| 100 | 10000 mm |

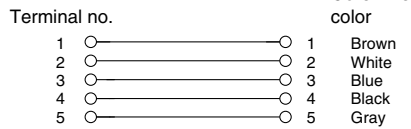
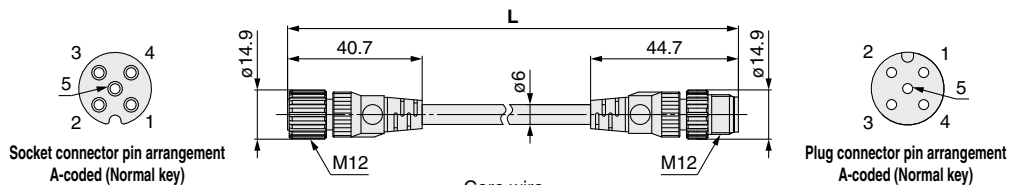

Connections

| Item | Specifications |
|--|----------------------------|
| Cable O.D. | ø6 mm |
| Conductor nominal cross section | 0.3 mm ² /AWG22 |
| Wire O.D. (Including conductor) | 1.5 mm |
| Min. bending radius (Fixed) | 40 mm |

EX9-AC 005 -SAPA (With connector on both sides (Socket/Plug))

• Cable length (L)

| | |
|-----|----------|
| 005 | 500 mm |
| 010 | 1000 mm |
| 020 | 2000 mm |
| 030 | 3000 mm |
| 050 | 5000 mm |
| 100 | 10000 mm |

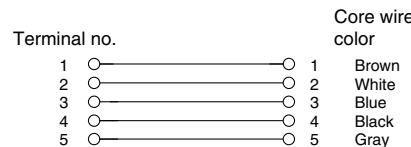
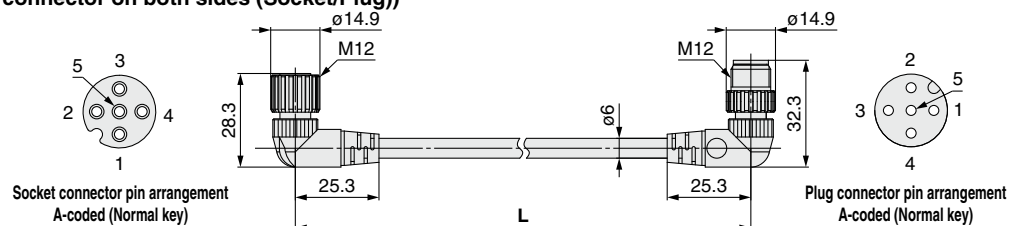

Connections

| Item | Specifications |
|--|----------------------------|
| Cable O.D. | ø6 mm |
| Conductor nominal cross section | 0.3 mm ² /AWG22 |
| Wire O.D. (Including conductor) | 1.5 mm |
| Min. bending radius (Fixed) | 40 mm |

① Communication Cable

For IO-Link

② Y branch connector

This connector is used to supply power to the valve manifold by branching the IO-Link communication cable in cases where a port class A IO-Link master is used.

EX9-ACY02-S

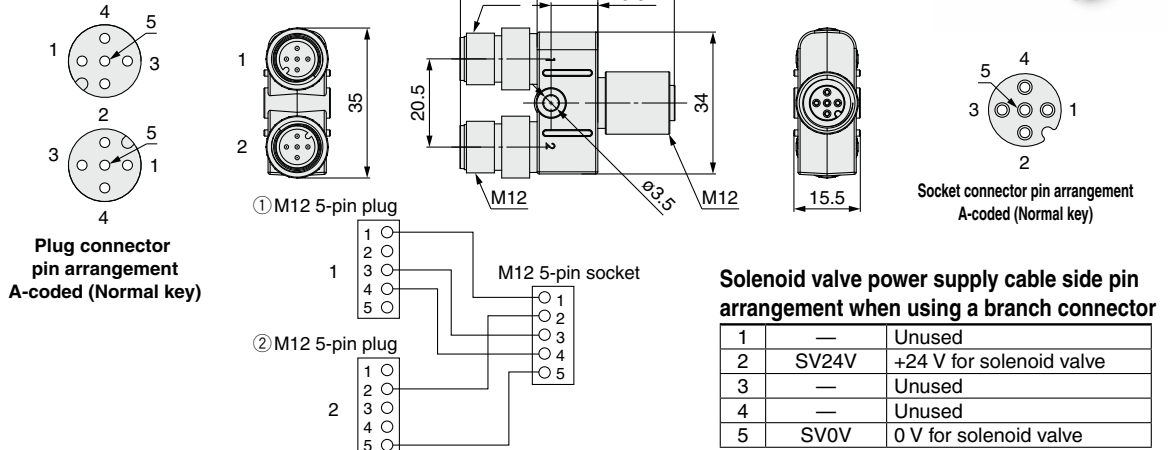

③ Communication cable

EX500-AP 050 -S

| Cable length (L) | | Connector specification | |
|------------------|---------|-------------------------|----------|
| 010 | 1000 mm | S | Straight |
| 050 | 5000 mm | A | Angled |

Straight connector type

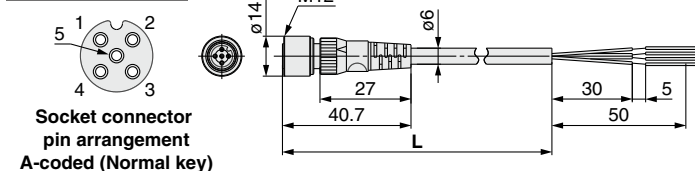

| Item | Specifications |
|---------------------------------|----------------------------|
| Cable O.D. | ø6 mm |
| Conductor nominal cross section | 0.3 mm ² /AWG22 |
| Wire O.D. (Including insulator) | 1.5 mm |
| Min. bending radius (Fixed) | 40 mm |

Angled connector type

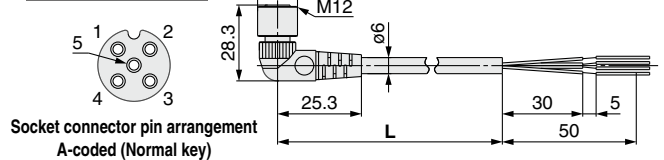

| Item | Specifications |
|---------------------------------|----------------------------|
| Cable O.D. | ø6 mm |
| Conductor nominal cross section | 0.3 mm ² /AWG22 |
| Wire O.D. (Including insulator) | 1.5 mm |
| Min. bending radius (Fixed) | 40 mm |



Made to Order

| | | |
|--------------|----------|-------|
| Cable length | 10000 mm | p. 27 |
|--------------|----------|-------|

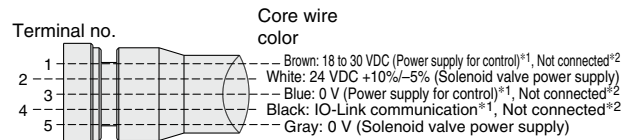

Connections (IO-Link) *1 When used as an IO-Link communication cable *2 When used as a solenoid valve power supply cable

PCA-1401804

| Cable length (L) | |
|------------------|---------|
| 1401804 | 1500 mm |
| 1401805 | 3000 mm |
| 1401806 | 5000 mm |

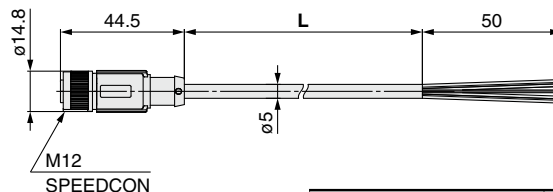
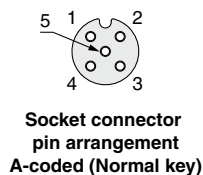

| Item | Specifications |
|---------------------------------|-----------------------------|
| Cable O.D. | ø5 mm |
| Conductor nominal cross section | 0.34 mm ² /AWG22 |
| Wire O.D. (Including insulator) | 1.27 mm |
| Min. bending radius (Fixed) | 21.7 mm |

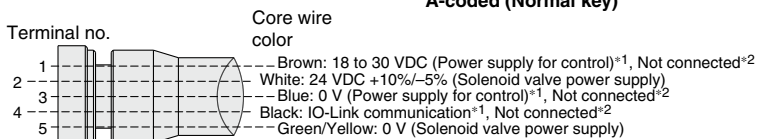

Connections (IO-Link) *1 When used as an IO-Link communication cable *2 When used as a solenoid valve power supply cable

EX260 Series

② Field-wireable Communication Connector

Plug

For CC-Link For DeviceNet™
PCA-1075526 PCA-1075528

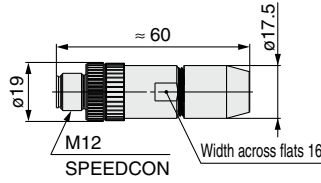

For PROFIBUS DP
PCA-1075530

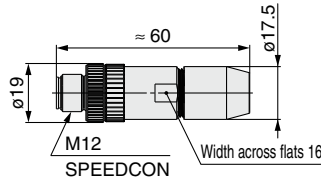

Applicable Cable

| Item | Specifications |
|--|---|
| Cable O.D. | 4.0 to 8.0 mm |
| Wire gauge (Stranded wire cross section) | 0.14 to 0.75 mm ² /AWG26 to 18 (Solid cable/Flexible cable) 0.08 to 0.5 mm ² /AWG28 to 20 (With ferrule) |

For EtherCAT For PROFINET For EtherNet/IP™ For Ethernet POWERLINK For PROFIsafe
PCA-1446553

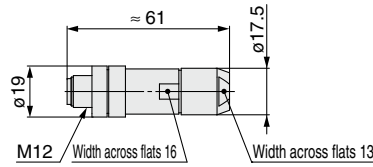
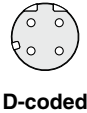

Applicable Cable

| Item | Specifications |
|--|---|
| Cable O.D. | 4.0 to 8.0 mm |
| Wire gauge (Stranded wire cross section) | 0.14 to 0.34 mm ² /AWG26 to 22 |

* The table above shows the specifications for the applicable cable. Adaptation for the connector may vary on account of the conductor construction of the electric wire.

Socket

For CC-Link For DeviceNet™
PCA-1075527 PCA-1075529

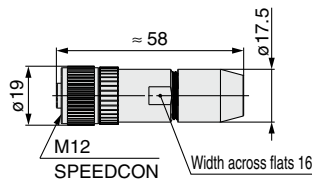

For PROFIBUS DP
PCA-1075531

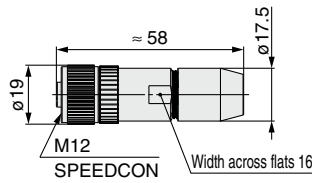
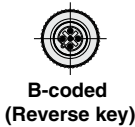

Applicable Cable

| Item | Specifications |
|--|---|
| Cable O.D. | 4.0 to 8.0 mm |
| Wire gauge (Stranded wire cross section) | 0.14 to 0.75 mm ² /AWG26 to 18 (Solid cable/Flexible cable) 0.08 to 0.5 mm ² /AWG28 to 20 (With ferrule) |

③ Power Supply Cable (For SI unit)

For PROFIBUS DP For DeviceNet™ For EtherCAT For PROFINET For EtherNet/IP™
 For Ethernet POWERLINK For PROFI-safe

EX500-AP 050 - S

Cable length (L)

| | |
|------------|---------|
| 010 | 1000 mm |
| 050 | 5000 mm |

Connector specification

| | |
|----------|----------|
| S | Straight |
| A | Angled |

Straight connector type

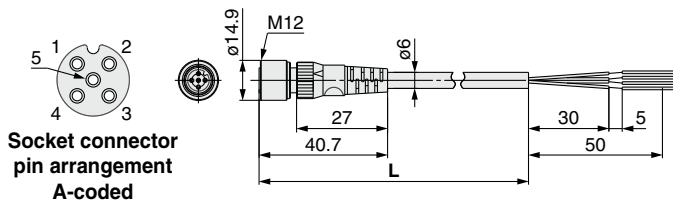

Angled connector type

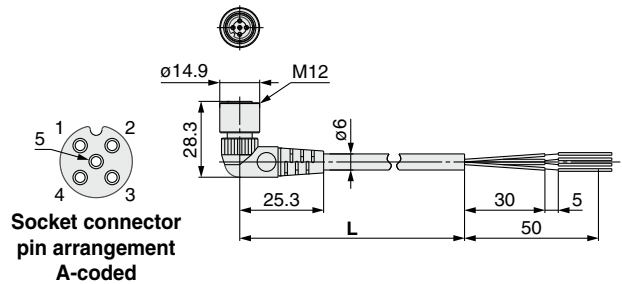

| Item | Specifications |
|--|----------------------------|
| Cable O.D. | ø6 mm |
| Conductor nominal cross section | 0.3 mm ² /AWG22 |
| Wire O.D. (Including insulator) | 1.5 mm |
| Min. bending radius (Fixed) | 40 mm |

| Item | Specifications |
|--|----------------------------|
| Cable O.D. | ø6 mm |
| Conductor nominal cross section | 0.3 mm ² /AWG22 |
| Wire O.D. (Including insulator) | 1.5 mm |
| Min. bending radius (Fixed) | 40 mm |

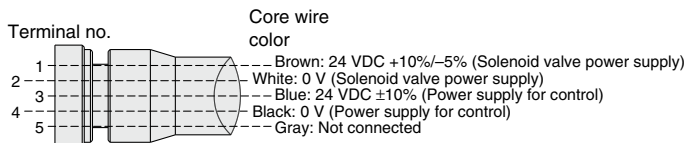

Connections (PROFIBUS DP, EtherCAT, PROFINET, Ethernet POWERLINK, PROFI-safe)

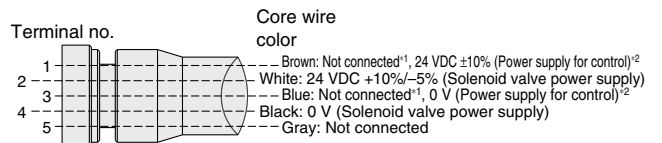

Connections (DeviceNet™, EtherNet/IP™) *1 For DeviceNet™ *2 For EtherNet/IP™



Made to Order

| | | |
|--------------|----------|-------|
| Cable length | 10000 mm | p. 27 |
|--------------|----------|-------|

PCA-1401804

Cable length (L)

| | |
|----------------|---------|
| 1401804 | 1500 mm |
| 1401805 | 3000 mm |
| 1401806 | 5000 mm |

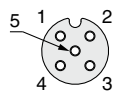

Socket connector pin arrangement A-coded

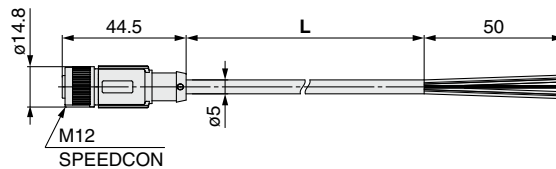

| Item | Specifications |
|--|-----------------------------|
| Cable O.D. | ø5 mm |
| Conductor nominal cross section | 0.34 mm ² /AWG22 |
| Wire O.D. (Including insulator) | 1.27 mm |
| Min. bending radius (Fixed) | 21.7 mm |

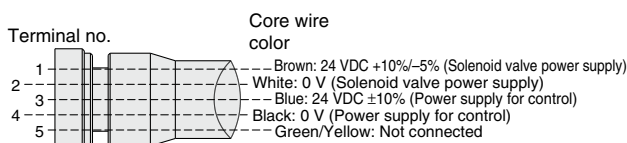

Connections (PROFIBUS DP, EtherCAT, PROFINET, Ethernet POWERLINK, PROFI-safe)

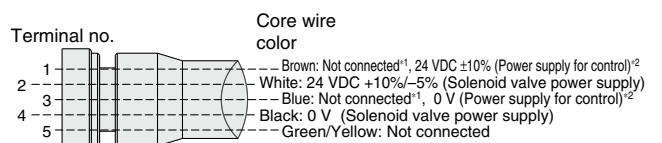

Connections (DeviceNet™, EtherNet/IP™) *1 For DeviceNet™ *2 For EtherNet/IP™

EX260 Series

④ Power Supply Cable (For SI unit/For power block)

For CC-Link For power block

Straight connector type

EX9-AC 050 -1

● Cable length (L)

| | |
|-----|---------|
| 010 | 1000 mm |
| 030 | 3000 mm |
| 050 | 5000 mm |

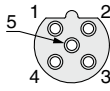

Socket connector pin arrangement B-coded

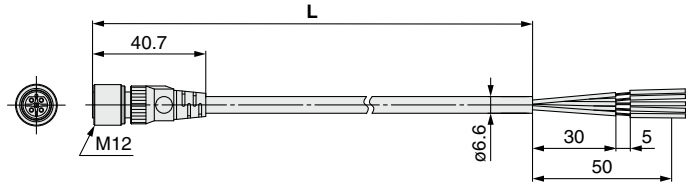

| Item | Specifications |
|---------------------------------|----------------------------|
| Cable O.D. | ø6.6 mm |
| Conductor nominal cross section | 0.3 mm ² /AWG22 |
| Wire O.D. (Including insulator) | 1.65 mm |
| Min. bending radius (Fixed) | 40 mm |



Made to Order

| | | |
|--------------|----------|-------|
| Cable length | 10000 mm | p. 27 |
|--------------|----------|-------|

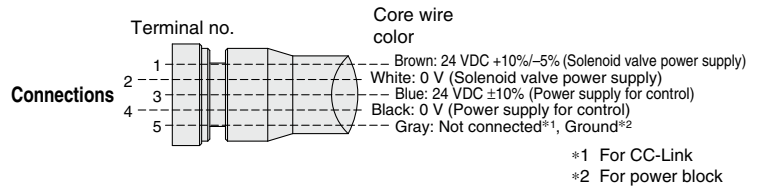

PCA-1401807

● Cable length (L)

| | |
|---------|---------|
| 1401807 | 1500 mm |
| 1401808 | 3000 mm |
| 1401809 | 5000 mm |

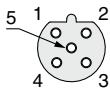

Socket connector pin arrangement B-coded

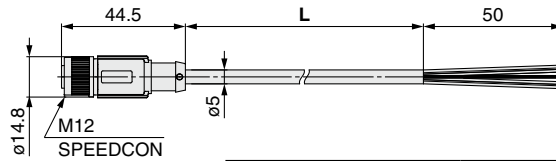

| Item | Specifications |
|---------------------------------|-----------------------------|
| Cable O.D. | ø5 mm |
| Conductor nominal cross section | 0.34 mm ² /AWG22 |
| Wire O.D. (Including insulator) | 1.27 mm |
| Min. bending radius (Fixed) | 21.7 mm |

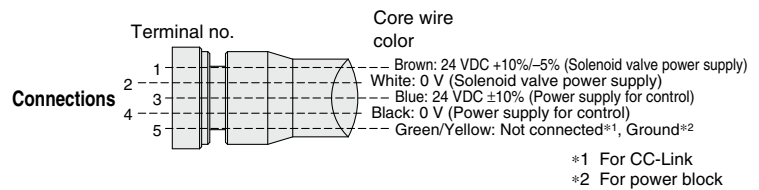

⑤ Seal Cap (10 pcs.)

Use this on ports that are not being used for communication connector (M12 connector socket). Use of this seal cap maintains the integrity of the IP67 enclosure.

* Tighten the seal cap with the prescribed tightening torque. (For M12: 0.1 N·m)

EX9-AW TS

● Connector specification

| | |
|----|------------------------------------|
| TS | For M12 connector socket (10 pcs.) |
|----|------------------------------------|

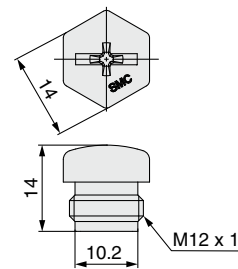

For M12 connector socket

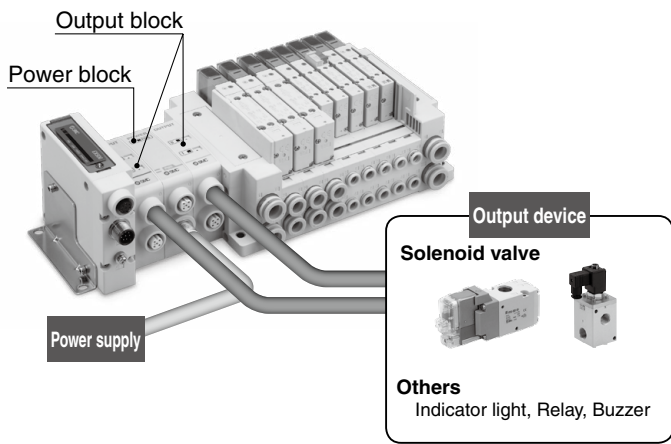

- Output devices other than valve manifold can be operated.
- By using the power block and output block for high watt load, operation up to 0.5 A/point can be performed.
- It is possible to mount the output block and power block additionally between the SI unit and the solenoid valve (The surplus I/O points are used).
- 2 point outputs per output block (M12 connector)

The output block and power block cannot be used with the PROFIsafe compatible SI unit EX260-FPS1.

You are requested to connect it to an SI unit and a valve manifold. For detailed specifications, refer to the operation manual that can be downloaded from SMC website: <https://www.smcworld.com>

6 Output Block

EX9-OE T 1

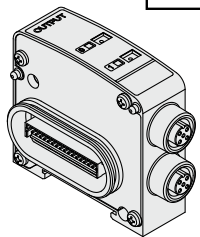

- Output specification

| | |
|---|------------------------------|
| 1 | Source/PNP (Negative common) |
| 2 | Sink/NPN (Positive common) |
 - Power supply type

| | |
|---|--|
| T | Internal power supply method (for low-wattage load) |
| P | Integrated power supply method (for high-wattage load)*1 |
- *1 Required to connect with a power block

Dimensions/Parts Description

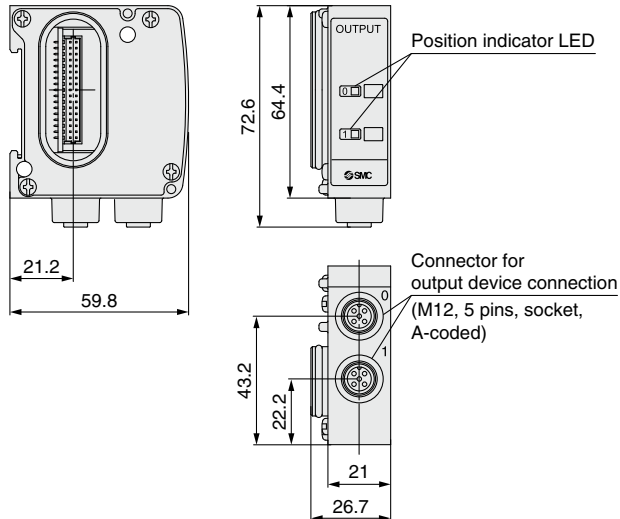

Specifications

| Model | EX9-OET1 | EX9-OET2 | EX9-OEP1 | EX9-OEP2 | |
|------------------------------|---|--------------------------------|----------------------------|---|----------------------------|
| Internal current consumption | 40 mA or less | | | | |
| Output | Output type | Source/PNP (Negative common) | Sink/NPN (Positive common) | Source/PNP (Negative common) | Sink/NPN (Positive common) |
| | Number of outputs | 2 outputs | | | |
| | Power supply method | Internal power supply method | | Integrated power supply method (Power block: supplied from EX9-PE1) | |
| | Output device supply voltage | 24 VDC | | | |
| | Output device supply current | Max. 42 mA/point (1.0 W/point) | | Max. 0.5 A/point (12 W/point) | |
| Environmental resistance | Enclosure | IP67 | | | |
| | Operating temperature range | -10 to 50°C | | | |
| | Operating humidity range | 35 to 85% RH (No condensation) | | | |
| Standards | CE marking (EMC directive/RoHS directive), UL (CSA) | | | | |
| Weight | 120 g | | | | |

7 Power Block

EX9-PE1

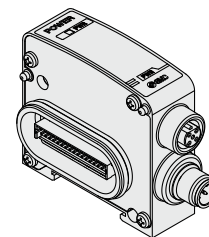

Dimensions/Parts Description

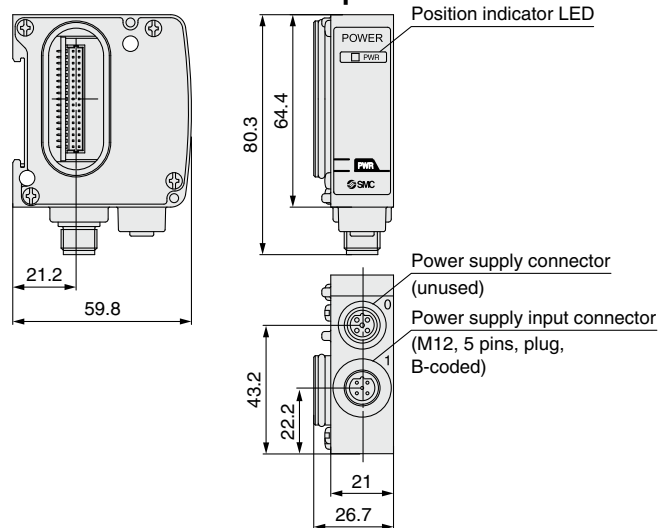

Specifications

| Model | EX9-PE1 | |
|--|---|--------------------------------|
| Connection block | Output block for high wattage load | |
| Connection block stations | Output block: Max. 8 stations | |
| Power supply for output and internal control | Power supply voltage | 22.8 to 26.4 VDC |
| | Internal current consumption | 20 mA or less |
| Supply current | Max. 3.1 A*1 | |
| Environmental resistance | Enclosure | IP67 |
| | Operating temperature range | -10 to 50°C |
| | Operating humidity range | 35 to 85% RH (No condensation) |
| Standards | CE marking (EMC directive/RoHS directive), UL (CSA) | |
| Weight | 120 g | |
| Enclosed parts | Seal cap (for M12 connector) 1 pc. | |

*1 When using with 3.0 to 3.1 A, the ambient temperature should not exceed 40°C, and do not bundle the cable.

Refer to page 23 for the power supply cable for power block.

EX260 Series

8 Connector for Output Block Wiring

Field-wireable connector for connecting an output device to an output block

PCA-1557743

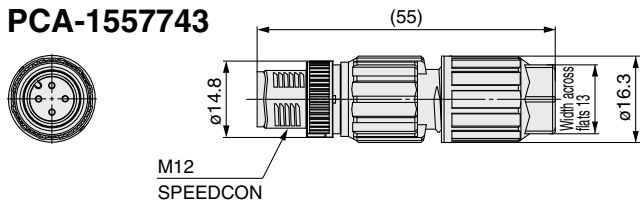

A-coded

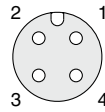

Plug pin arrangement

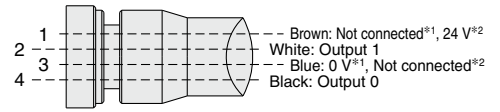

Connections

- *1 When used for EX9-OE□1
- *2 When used for EX9-OE□2

Applicable Cable

| Item | Specifications |
|--|---|
| Cable O.D. | 3.5 to 6.0 mm |
| Wire gauge (Stranded wire cross section) | 0.14 to 0.34 mm ² /AWG26 to 22 |
| Core wire diameter (Including insulating material) | 0.7 to 1.3 mm |

PCA-1557756

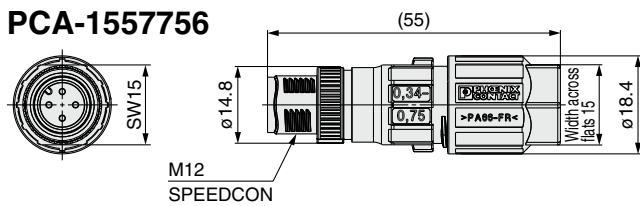

A-coded

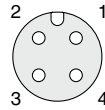

Plug pin arrangement

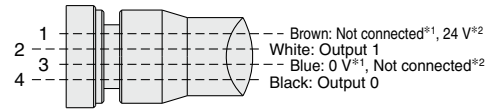

Connections

- *1 When used for EX9-OE□1
- *2 When used for EX9-OE□2

Applicable Cable

| Item | Specifications |
|--|---|
| Cable O.D. | 4.0 to 8.0 mm |
| Wire gauge (Stranded wire cross section) | 0.34 to 0.75 mm ² /AWG22 to 18 |
| Core wire diameter (Including insulating material) | 1.3 to 2.5 mm |

Refer to page 23 for the power supply cable for power block.

9 End Plate

Use when an output block is being used and a valve manifold is not connected.

EX9-EA03

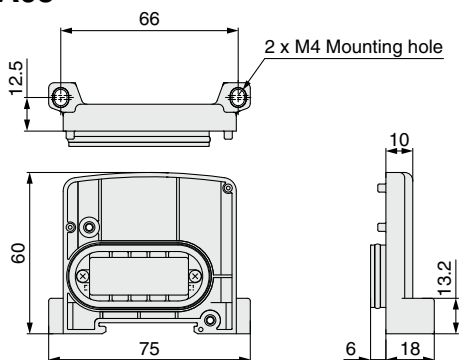

<Example of use>

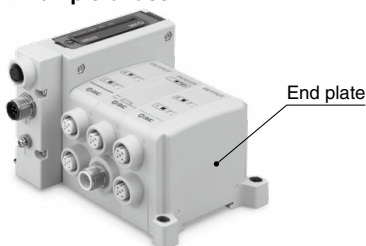

10 Bracket Plate/DIN Rail Mounting Bracket

A reinforcing brace used to mount an output block or power block onto an SI unit. To prevent connection failure between products due to deflection, use this bracket plate whenever an output block or power block is mounted.

EX9-BP1

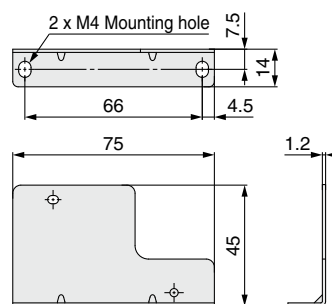

EX9-BD1

(For VQC, S0700, SV)

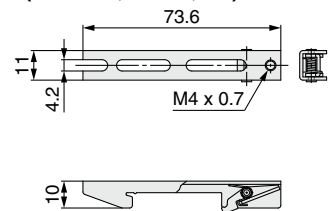

Accessory

| Description | Qty. |
|---|------|
| Hexagon socket head cap screw (M3 x 35) | 2 |

Accessory

| Description | Qty. |
|--|------|
| Domed cap nut (M4) | 1 |
| Round head combination screw (M4 x 8) | 1 |
| Round head combination screw (M4 x 10) | 1 |

<Example of use>

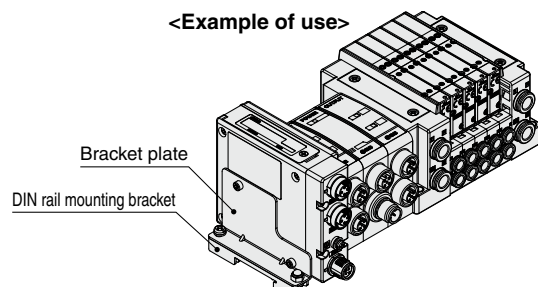

EX260 Series Made to Order

Please contact SMC for detailed specifications and lead times.



SI Unit

Prepare the SI unit and valve manifold (without SI unit) separately, and combine them before use.

EtherNet/IP™ Web server function compatible

EX260-SEN1-X194

- Web server compatible: Can conduct a solenoid valve operation test (ON/OFF), check communication state, set QuickConnect™, etc.
- Applicable to the power supply taken from Rockwell Automation's safe output module with pulse test function
- Compliant with QuickConnect™ class A specifications
- The gateway address is set to 192.168.□.001 when the IP address is set by the rotary switch.
- Dimensions are the same as those of the standard type.

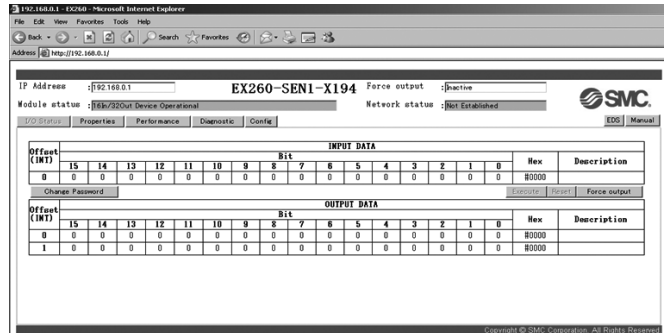

Web server screen (Example)

Communication Cable

With connector on one side (Socket)
Cable length: 10000 mm

For CC-Link

For CC-Link

For DeviceNet™

EX9-AC100 MJ-X12

• Applicable protocol

| | |
|----|------------|
| MJ | CC-Link |
| DN | DeviceNet™ |

Socket connector pin arrangement
A-coded (Normal key)

*1 Number of holes: 5, Total number of pins: 4

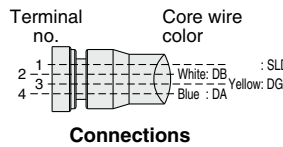
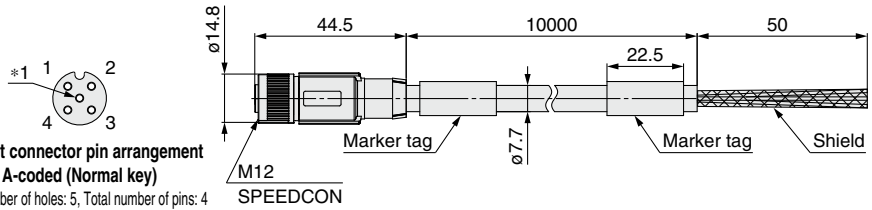

Connections

| Item | Specifications |
|--|---------------------------------------|
| Cable O.D. | ø7.7 mm |
| Conductor nominal cross section | Data pair: 0.5 mm ² /AWG20 |
| | Drain: 0.34 mm ² /AWG22 |
| Wire O.D. (Including insulator) | 2.55 mm |
| Min. bending radius (Fixed) | 77 mm |

For DeviceNet™

Socket connector pin arrangement
A-coded (Normal key)

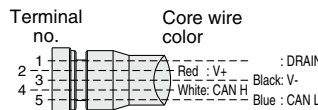
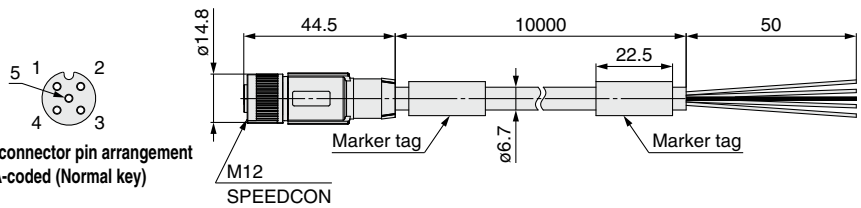

Connections

| Item | Specifications |
|--|---|
| Cable O.D. | ø6.7 mm |
| Conductor nominal cross section | Power pair: 0.34 mm ² /AWG22 |
| | Data pair: 0.25 mm ² /AWG24 |
| Wire O.D. (Including insulator) | Power pair: 1.4 mm |
| | Data pair: 2.05 mm |
| Min. bending radius (Fixed) | 67 mm |

EX260 Series

Power Supply Cable

① With connector on one side (Socket)

Cable length: 10000 mm

For CC-Link For power block

EX9-AC100-1-X16

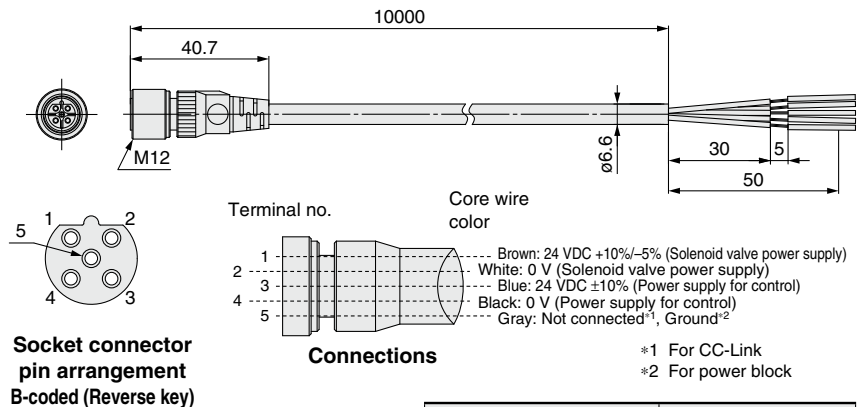

| Item | Specifications |
|---------------------------------|----------------------------|
| Cable O.D. | ø6.6 mm |
| Conductor nominal cross section | 0.3 mm ² /AWG22 |
| Wire O.D. (Including insulator) | 1.65 mm |
| Min. bending radius (Fixed) | 40 mm |

② With connector on one side (Socket)

Cable length: 10000 mm

For PROFIBUS DP For DeviceNet™ For EtherCAT For PROFINET For EtherNet/IP™

For Ethernet POWERLINK For IO-Link For PROFI-safe

EX500-AP100-**S**-X1

Connector specification

| | |
|----------|----------|
| S | Straight |
| A | Angled |

Straight connector type

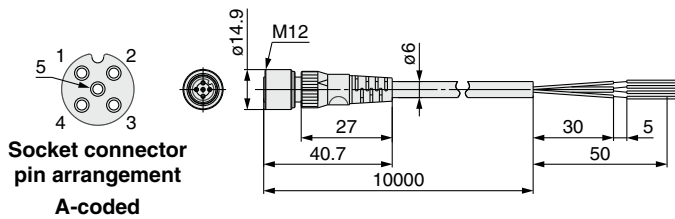

| Item | Specifications |
|---------------------------------|----------------------------|
| Cable O.D. | ø6 mm |
| Conductor nominal cross section | 0.3 mm ² /AWG22 |
| Wire O.D. (Including insulator) | 1.5 mm |
| Min. bending radius (Fixed) | 40 mm |

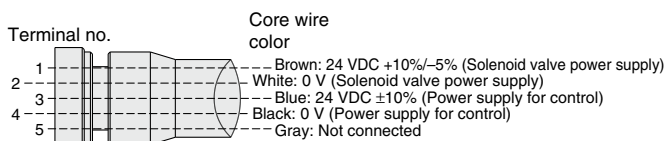

Connections (PROFIBUS DP, EtherCAT, PROFINET, Ethernet POWERLINK, PROFI-safe)

Angled connector type

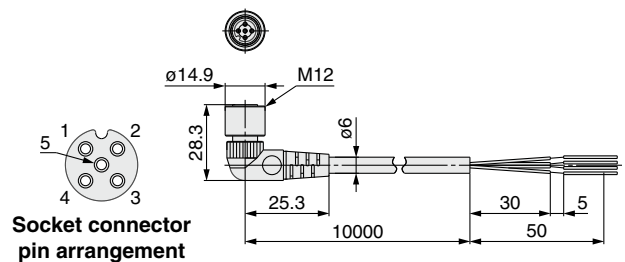

| Item | Specifications |
|---------------------------------|----------------------------|
| Cable O.D. | ø6 mm |
| Conductor nominal cross section | 0.3 mm ² /AWG22 |
| Wire O.D. (Including insulator) | 1.5 mm |
| Min. bending radius (Fixed) | 40 mm |

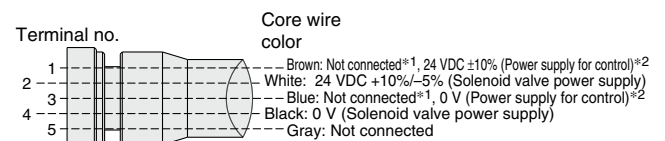

Connections (DeviceNet™, EtherNet/IP™)
*1 For DeviceNet™
*2 For EtherNet/IP™

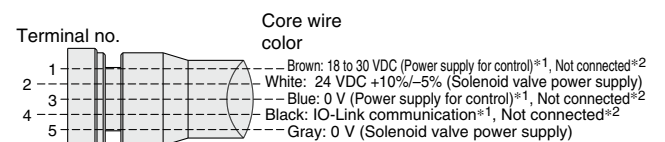

Connections (IO-Link)
*1 When used as an IO-Link communication cable
*2 When used as a solenoid valve power supply cable



EX260 Series

Specific Product Precautions

Be sure to read this before handling the products. Refer to the back cover for safety instructions. For fieldbus system precautions, refer to the “Handling Precautions for SMC Products” and the “Operation Manual” on the SMC website: <https://www.smcworld.com>

Wiring

Caution

1. **Select connectors that are $\phi 16$ or less if mounting valve manifolds directly using field-wireable connectors for SI unit power supply wiring.**

Using large diameter connectors causes interference with the mounting surface.

The following cables with connectors are recommended.

■ **For EX260-SPR□/SDN□/SEC□/SPN□/SEN□/SPL□/**
-FPS1

<Cable with connector>

- EX500-AP□□□-□
- PCA-1401804/-1401805/-1401806

■ **For EX260-SMJ□**

<Cable with connector>

- EX9-AC□□□-1
- PCA-1401807/-1401808/-1401809

Adjustment / Operation

Caution

1. **For details on programming and address setting, refer to the manual from the PLC manufacturer.**

The programming content related to the protocol is designed by the manufacturer of the PLC used.

2. **For the EX260-SPN□, the side of the SI unit may become hot.**

It may cause burns.

Operating Environment

Caution

1. **Select the proper type of enclosure according to the operating environment.**

IP67 is achieved when the following conditions are met.

- 1) Provide appropriate wiring between all units using electrical wiring cables, communication connectors and cables with M12 connectors.
- 2) Appropriately mount each unit and valve manifold.
- 3) Be sure to mount a seal cap on any unused connectors.

If using in an environment that is exposed to water splashes, please take measures such as using a cover.

When the enclosure is IP40, do not use in an operating environment or atmosphere where it may come in contact with corrosive gas, chemical agents, seawater, water, or water vapor.

When connected to the EX260-SPR5/6/7/8, manifold enclosure is IP40.

■ Trademark

DeviceNet™ is a trademark of ODVA.

EtherNet/IP™ is a trademark of ODVA.

EtherCAT® is registered trademark and patented technology, licensed by Beckhoff Automation GmbH, Germany.

Modbus® is a registered trademark of Schneider Electric, licensed to the Modbus Organization, Inc.

QuickConnect™ is a trademark of ODVA.

Safety Instructions

These safety instructions are intended to prevent hazardous situations and/or equipment damage. These instructions indicate the level of potential hazard with the labels of “**Caution**,” “**Warning**” or “**Danger**.” They are all important notes for safety and must be followed in addition to International Standards (ISO/IEC)*1), and other safety regulations.

 **Caution:** **Caution** indicates a hazard with a low level of risk which, if not avoided, could result in minor or moderate injury.

 **Warning:** **Warning** indicates a hazard with a medium level of risk which, if not avoided, could result in death or serious injury.

 **Danger :** **Danger** indicates a hazard with a high level of risk which, if not avoided, will result in death or serious injury.

*1) ISO 4414: Pneumatic fluid power – General rules relating to systems.
ISO 4413: Hydraulic fluid power – General rules relating to systems.
IEC 60204-1: Safety of machinery – Electrical equipment of machines.
(Part 1: General requirements)
ISO 10218-1: Manipulating industrial robots – Safety.
etc.

Warning

1. The compatibility of the product is the responsibility of the person who designs the equipment or decides its specifications.

Since the product specified here is used under various operating conditions, its compatibility with specific equipment must be decided by the person who designs the equipment or decides its specifications based on necessary analysis and test results. The expected performance and safety assurance of the equipment will be the responsibility of the person who has determined its compatibility with the product. This person should also continuously review all specifications of the product referring to its latest catalog information, with a view to giving due consideration to any possibility of equipment failure when configuring the equipment.

2. Only personnel with appropriate training should operate machinery and equipment.

The product specified here may become unsafe if handled incorrectly. The assembly, operation and maintenance of machines or equipment including our products must be performed by an operator who is appropriately trained and experienced.

3. Do not service or attempt to remove product and machinery/equipment until safety is confirmed.

1. The inspection and maintenance of machinery/equipment should only be performed after measures to prevent falling or runaway of the driven objects have been confirmed.
2. When the product is to be removed, confirm that the safety measures as mentioned above are implemented and the power from any appropriate source is cut, and read and understand the specific product precautions of all relevant products carefully.
3. Before machinery/equipment is restarted, take measures to prevent unexpected operation and malfunction.

4. Contact SMC beforehand and take special consideration of safety measures if the product is to be used in any of the following conditions.

1. Conditions and environments outside of the given specifications, or use outdoors or in a place exposed to direct sunlight.
2. Installation on equipment in conjunction with atomic energy, railways, air navigation, space, shipping, vehicles, military, medical treatment, combustion and recreation, or equipment in contact with food and beverages, emergency stop circuits, clutch and brake circuits in press applications, safety equipment or other applications unsuitable for the standard specifications described in the product catalog.
3. An application which could have negative effects on people, property, or animals requiring special safety analysis.
4. Use in an interlock circuit, which requires the provision of double interlock for possible failure by using a mechanical protective function, and periodical checks to confirm proper operation.

Caution

1. The product is provided for use in manufacturing industries.

The product herein described is basically provided for peaceful use in manufacturing industries.
If considering using the product in other industries, consult SMC beforehand and exchange specifications or a contract if necessary.
If anything is unclear, contact your nearest sales branch.

Limited warranty and Disclaimer/ Compliance Requirements

The product used is subject to the following “Limited warranty and Disclaimer” and “Compliance Requirements”.

Read and accept them before using the product.

Limited warranty and Disclaimer

1. The warranty period of the product is 1 year in service or 1.5 years after the product is delivered, whichever is first.*2)
Also, the product may have specified durability, running distance or replacement parts. Please consult your nearest sales branch.
2. For any failure or damage reported within the warranty period which is clearly our responsibility, a replacement product or necessary parts will be provided.
This limited warranty applies only to our product independently, and not to any other damage incurred due to the failure of the product.
3. Prior to using SMC products, please read and understand the warranty terms and disclaimers noted in the specified catalog for the particular products.

*2) Vacuum pads are excluded from this 1 year warranty.

A vacuum pad is a consumable part, so it is warranted for a year after it is delivered.
Also, even within the warranty period, the wear of a product due to the use of the vacuum pad or failure due to the deterioration of rubber material are not covered by the limited warranty.

Compliance Requirements

1. The use of SMC products with production equipment for the manufacture of weapons of mass destruction (WMD) or any other weapon is strictly prohibited.
2. The exports of SMC products or technology from one country to another are governed by the relevant security laws and regulations of the countries involved in the transaction. Prior to the shipment of a SMC product to another country, assure that all local rules governing that export are known and followed.

Caution

SMC products are not intended for use as instruments for legal metrology.

Measurement instruments that SMC manufactures or sells have not been qualified by type approval tests relevant to the metrology (measurement) laws of each country. Therefore, SMC products cannot be used for business or certification ordained by the metrology (measurement) laws of each country.

Revision History

| | | |
|------------------|--|----|
| Edition B | * EtherNet/IP™ has been added to applicable Fieldbus protocols. | QS |
| Edition C | * The IO-Link compatible EX260-SIL1 has been added. * Accessories and made-to-order specifications have been added. * “How to Order Manifold” and “Dimensions” pages have been deleted. * Number of pages has been decreased from 52 to 28. | XU |
| Edition D | * A functional safety standard compliant product has been added. * Number of pages has been increased from 28 to 32. | ZS |

Safety Instructions

Be sure to read the “Handling Precautions for SMC Products” (M-E03-3) and “Operation Manual” before use.

Fieldbus System *EX260 Series* SI Unit



LAN cable connectable RJ45 communication connectors

- Communication protocol: EtherNet/IP™
- Number of outputs: 32

LAN cable*1 connectable
RJ45 communication connectors

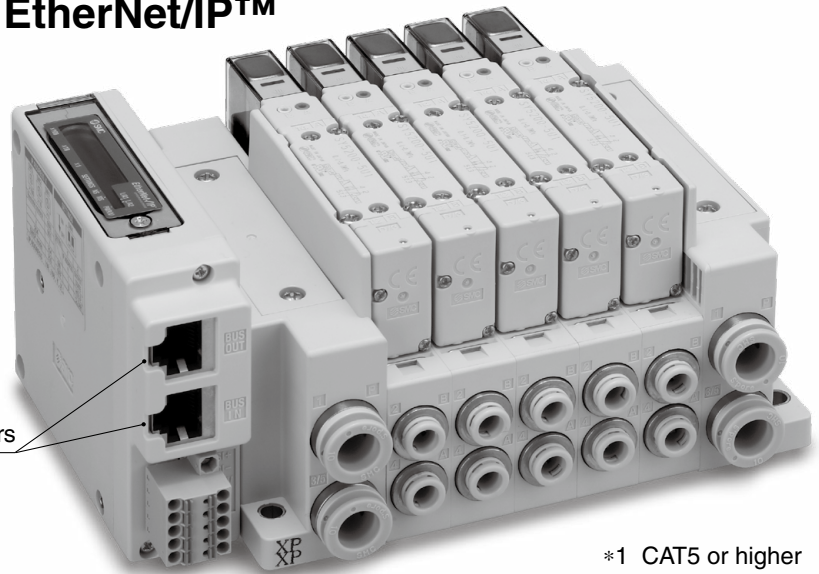

■ **Trademark**
EtherNet/IP™ is a trademark of ODVA.
QuickConnect™ is a trademark of ODVA.

*1 CAT5 or higher
* Enclosure: IP20

■ Applicable Valve Series

| Series | Flow rate characteristics (4/2 → 5/3) | | Max. number of solenoids | Power consumption [W] | Applicable cylinder size | |
|--------------|---------------------------------------|------|--------------------------|-----------------------|--|------|
| | C [dm ³ /(s·bar)] | b | | | | |
| JSY Series*2 | JSY1000 | 0.91 | 0.48 | 32 | 0.2 (With power-saving circuit) | ø40 |
| | JSY3000 | 2.77 | 0.27 | | 0.4 (Standard) | ø50 |
| | JSY5000 | 6.59 | 0.22 | | 0.1 (With power-saving circuit) | ø80 |
| SY Series | SY3000 | 1.6 | 0.19 | 32 | 0.35 (Standard) 0.1 (With power-saving circuit) | ø50 |
| | SY5000 | 3.6 | 0.17 | | | ø63 |
| | SY7000 | 5.9 | 0.20 | | | ø80 |
| VQC Series*2 | VQC1000 | 1.0 | 0.30 | 24 | 0.4 (Standard) | ø40 |
| | VQC2000 | 3.2 | 0.30 | | | ø63 |
| | VQC4000 | 7.3 | 0.38 | | 0.95 (Standard) 0.4 (Low-wattage type) | ø160 |
| | VQC5000 | 17 | 0.31 | | | ø180 |

*2 The assembly of JSY and VQC series valves should be requested separately by the customer. Specify "without SI unit" and "positive common" or "non-polar" for the valve manifold specifications.

EX260-SEN2-X205



19-E731

EX260-SEN2-X205

■ **Daisy-chain wiring of communication cables and power supply cables is possible.**

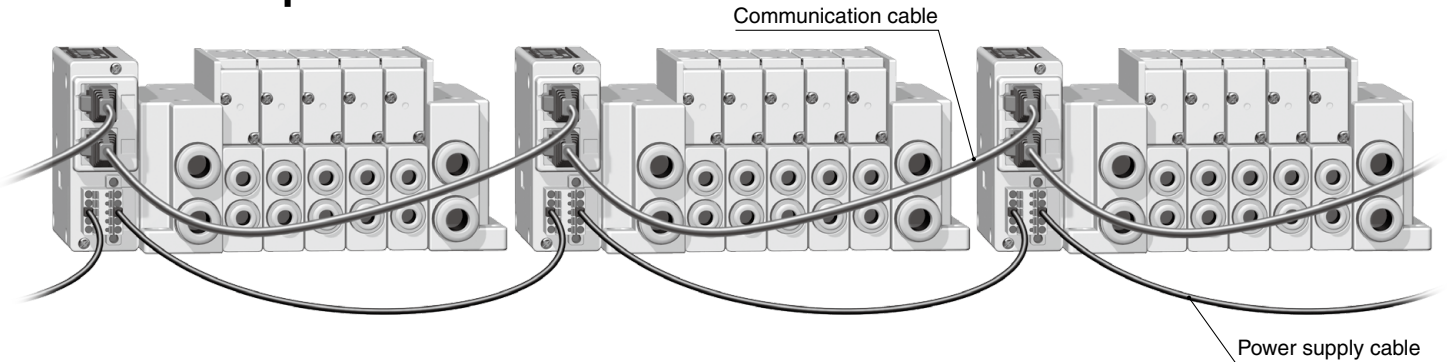

Compatible Topologies

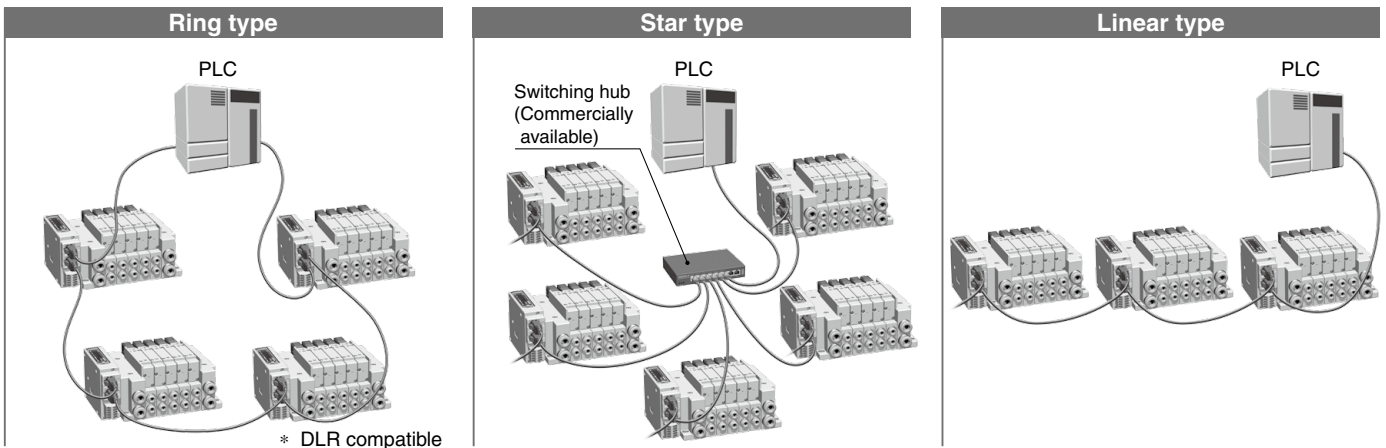

■ **Both air and electric systems can be constructed with RJ45 communication cables.**

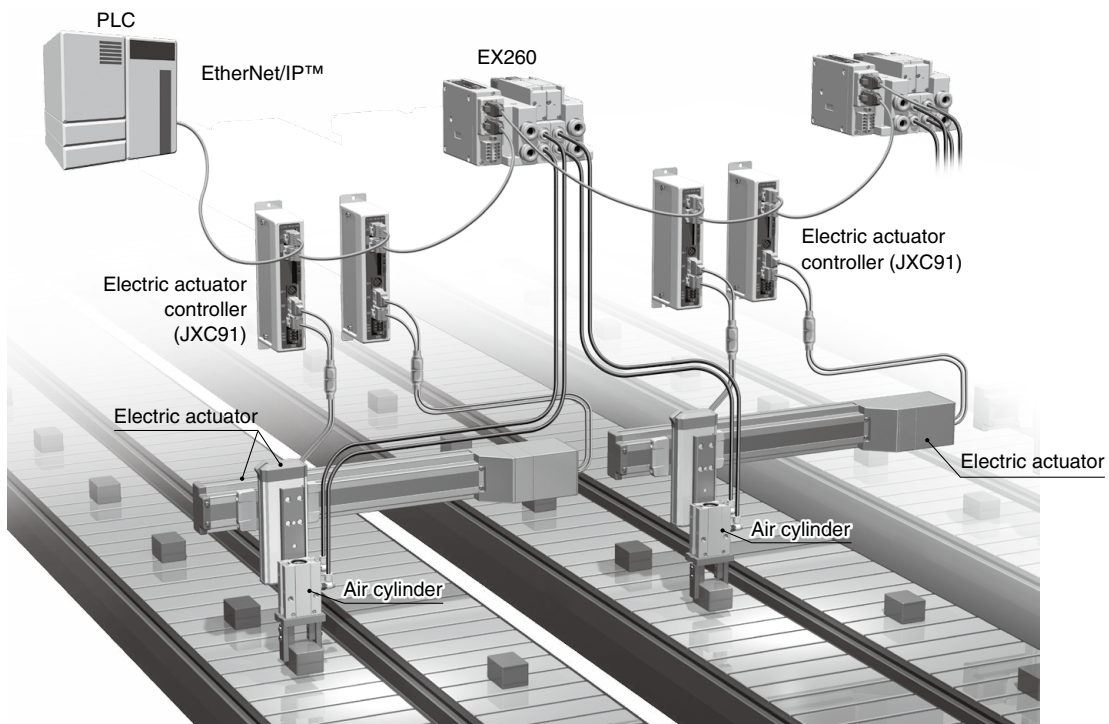

How to Order SI Units



EX260-S EN2-X205

Communication protocol

EN EtherNet/IP™

Connector specification

X205 Communication connector: RJ45
Power connector: Spring type connector

Output specification

2 32 outputs, NPN (Positive common)/Sink

Specifications

| Item | Specifications | |
|--------------------------|--|---|
| Protocol | EtherNet/IP™ Volume 1 (Edition 3.25) Volume 2 (Edition 1.23) | |
| Transmission medium | Standard Ethernet cable (CAT5 or higher) (100BASE-TX) | |
| Transmission speed | 100 Mbps/10 Mbps (Automatic negotiation) | |
| Transmission method | Full duplex/Half duplex (Automatic negotiation) | |
| Device information | Vendor ID: 7 (SMC Corp.) Device type: 27 (Pneumatic Valve) | |
| Applicable function | QuickConnect™ DLR | |
| EDS file | ex260_sen2_X205_24_v*.eds | |
| Output | Number of outputs | 32 |
| | Output type | Sink/NPN (Positive common) |
| | Connected load | Solenoid valve with surge voltage suppressor of 24 VDC and 1.5 W or less (manufactured by SMC) |
| | Power supply for solenoid valve | 2.0 A or less, according to the solenoid valve station specification |
| | Residual voltage | 0.4 VDC or less |
| Power supply for control | 21.6 to 26.4 VDC 0.1 A or less | |
| Enclosure | IP20 (with manifold assembled) | |
| Weight | 200 g or less (including accessories) | |

EtherNet/IP™ communication connector
BUS OUT: RJ45 8 pins, socket



| No. | Designation | No. | Designation |
|-----|-------------|-----|-------------|
| 1 | Tx+ | 5 | - |
| 2 | Tx- | 6 | Rx- |
| 3 | Rx+ | 7 | - |
| 4 | - | 8 | - |

EtherNet/IP™ communication connector
BUS IN: RJ45 8 pins, socket



| No. | Designation | No. | Designation |
|-----|-------------|-----|-------------|
| 1 | Tx+ | 5 | - |
| 2 | Tx- | 6 | Rx- |
| 3 | Rx+ | 7 | - |
| 4 | - | 8 | - |

Accessory

| Description | Qty. |
|---|------|
| Hexagon socket head cap screw (M3 x 30) | 2 |
| RJ45 cap | 1 |
| Power connector | 1 |

Power connector PWR: 5 pins, socket

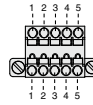

| No. | Designation | Function | No. | Designation | Function |
|-----|-------------|--------------------------|-----|-------------|------------------------|
| 1 | FE | Grounding | 4 | SI0V | 0 V for control unit |
| 2 | SV0V | 0 V for solenoid valve | 5 | SI24V | +24 V for control unit |
| 3 | SV24V | +24 V for solenoid valve | | | |

Applicable wire for power supply connector

| | |
|---|---|
| Wire gauge (Solid cable/Flexible cable) | 0.2 to 1.5 mm ² /AWG24 to 16 |
|---|---|

Dimensions

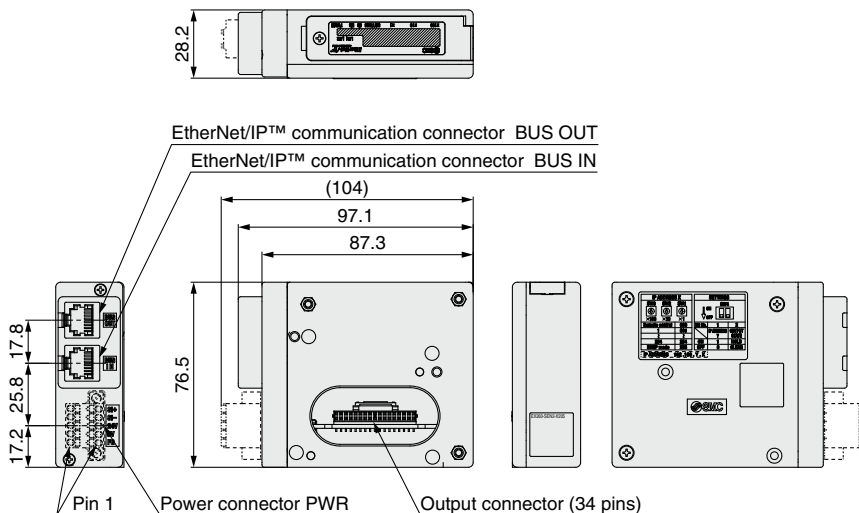

Caution

- The dimensions when combined with the valve manifold are the same as the dimensions of the valve manifold with a standard EX260 series unit mounted.
- For the JSY and VQC series, order the valve manifold separately.
Specify "without SI unit" and "positive common" or "non-polar" for the valve manifold specifications.

LED Indicator

| LED | LED Status | Details |
|--------|-----------------------|--|
| NS | OFF | Power is not being supplied or the IP address is not set. |
| | Green LED is ON | EtherNet/IP™ communication established |
| | Green LED is flashing | EtherNet/IP™ communication not established |
| | Red LED is flashing | EtherNet/IP™ connection time out |
| MS | Red LED is ON | IP duplicated |
| | OFF | Power is not being supplied. |
| | Green LED is ON | Operating normally |
| | Green LED is flashing | Setting error |
| L/A1 | Red LED is flashing | Recoverable error |
| | Red LED is ON | Unrecoverable error |
| | OFF | BUS IN side: No link, No activity |
| L/A2 | Green LED is ON | BUS IN side: Link, No activity |
| | Green LED is flashing | BUS IN side: Link, Activity |
| | OFF | BUS OUT side: No link, No activity |
| PWR(V) | Green LED is ON | BUS OUT side: Link, No activity |
| | Green LED is flashing | BUS OUT side: Link, Activity |
| | Yellow LED is ON | Power is being supplied to the valve. |
| | OFF | Power is not being supplied to the valve or is outside the tolerance range (19 V or less). |

EX260-SEN2-X205

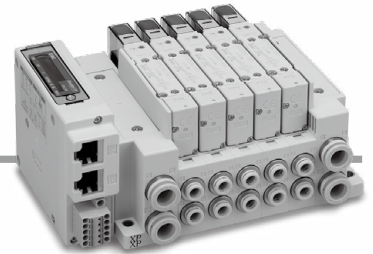

SY3000/5000/7000 Series

How to Order Manifold

Type

| | |
|----|-----------------------------|
| 10 | Side ported |
| 11 | Bottom ported ^{*1} |

^{*1} The bottom-porting type is not available for the SY3000.

Side/Bottom ported

Type 10/11 SS5Y 3 - 10 SEC - 05 U □ - C6 □ - X1100

Top ported

Type 12 SS5Y 3 - 12 SEC - 05 U □ - □ - X1100

Valve series

| | |
|---|--------|
| 3 | SY3000 |
| 5 | SY5000 |
| 7 | SY7000 |

Valve stations

| Symbol | Stations | Note |
|--------|-------------|--|
| 02 | 2 stations | Double wiring ^{*2} |
| ⋮ | ⋮ | |
| 16 | 16 stations | Specified layout ^{*3} (Up to 32 solenoids available) |
| 02 | 2 stations | |
| ⋮ | ⋮ | |
| 24 | 24 stations | |

P, E port entry

| | |
|---|-------------------------------|
| U | U side (2 to 10 stations) |
| D | D side (2 to 10 stations) |
| B | Both sides (2 to 24 stations) |

A, B port size
^{*} Refer to the Web Catalog.

Mounting and Option
^{*} Refer to the Web Catalog.

Mounting

| | | |
|-----|--------------------------------------|---|
| Nil | Direct mounting | |
| D | DIN rail mounting (with DIN rail) | |
| D0 | DIN rail mounting (without DIN rail) | |
| D3 | For 3 stations | Specify a length longer than that of the standard rail. |
| ⋮ | ⋮ | |
| D24 | For 24 stations | |

P, E port size (One-touch fitting)

| Symbol | SY3000 | SY5000 | SY7000 |
|--------|--------|--------|--------|
| Nil | ø8 | ø10 | ø12 |
| N | ø5/16" | ø3/8" | ø1/2" |

^{*} For N, sizes are in inches.

SUP/EXH block assembly

| | |
|-----|-----------------------------------|
| Nil | Internal pilot |
| S | Internal pilot, Built-in silencer |
| R | External pilot |

^{*2} Double wiring: 2-position single, double, 3-position, and 4-position valves can be used on all manifold stations. Use of a 2-position single solenoid will result in an unused control signal. If this is not desired, order with a specified layout.

^{*3} Double wiring is normally used for all the wiring of the manifold. If other wiring is required, specify on the manifold specification sheet.

^{*} Valves do not come assembled for order no. "SS5Y□-□SEC-□□□-□□-□X1100." Specify on the manifold specification sheet separately to request assembly.

^{*} Produced upon receipt of order.

How to Order Valves

SY □ □ □ □ □ □ □ □ - 5 U □ 1 - □

Enter the standard product number.

Enter the standard product number.

Light/surge voltage suppressor and common specification

| Symbol | With light | Surge voltage suppressor | Common specification |
|--------|------------|--------------------------|----------------------|
| R | — | ● | Non-polar |
| U | ● | | Positive common |
| S | — | | |
| Z | ● | | |

⚠ Safety Instructions Be sure to read the "Handling Precautions for SMC Products" (M-E03-3) and "Operation Manual" before use.