

5 Port Solenoid Valve

VF1000/3000/5000 Series

Reduced power consumption:

0.55 W [With power saving circuit]
[Starting 1.55 w Holding 0.55 w]

1.55 W [Standard]
(Current: 2.0 W) * With DC light

Power consumption is reduced by power saving circuit.

Power consumption is decreased by approx. 1/3 by reducing the wattage required to hold the valve in an energized state. (Effective energizing time is over 40 ms at 24 VDC.) Refer to electrical power waveform as shown below.

Electrical power waveform with power saving circuit

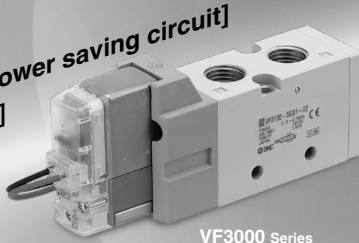
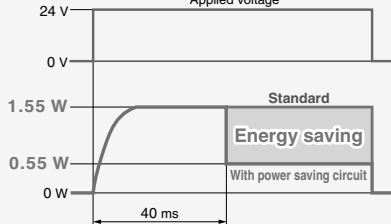

VF3000 Series



Low wattage specification added
* VF1000/3000

Power consumption **0.35 w** (Without light)
0.4 w (With light)



■ Built-in full-wave rectifier (AC)

● Noise reduction

Noise is considerably reduced by changing it to DC mode with a full-wave rectifier.

● Reduced apparent power

Current: **5.6 VA** → **1.55 VA**

■ Built-in strainer in the pilot valve

Unexpected troubles due to foreign matter can be prevented.
Note) Be sure to mount an air filter on the inlet side.

Rubber material: HNBR
Ozone-resistant specification
* The pilot valve poppet is made of FKM.

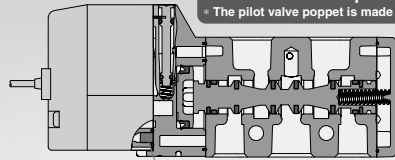

Strainer



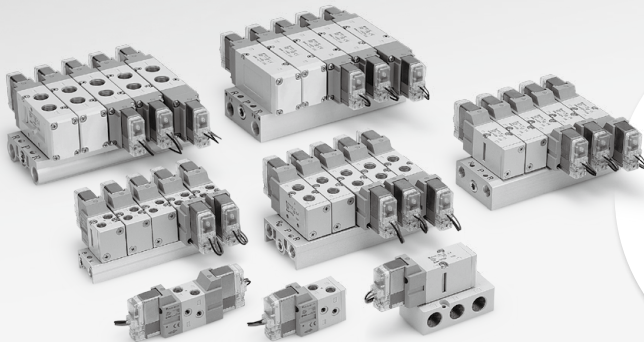
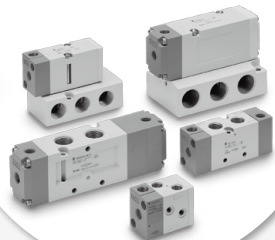

















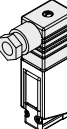

Air operated valve
VFA1000/3000/5000 P.1495

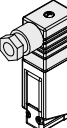

SV
SYJ
SZ
VF
VP4
VQ 1/2
VQ 4/5
VQC 1/2
VQC 4/5
VQZ
SQ
VFS
VFR
VQ7

Model Selection by Operating Conditions 1

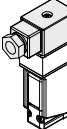
Solenoid Valve: Single Unit

Series	Sonic conductance C [dm ³ /(s·bar)]	Type of actuation	Port size	Voltage	Electrical entry	Light/Surge voltage suppressor	Manual override
Body ported	VF1000 	2-position single VF1000  (B)2 4(A) (EB)3 1 5(EA) (P)	M5 x 0.8 1/8		Grommet 		
		2-position double VF1000  (B)2 4(A) (EB)3 1 5(EA) (P)			L-type plug connector 		
	VF3000 	2-position double VF1000  (B)2 4(A) (EB)3 1 5(EA) (P)	1/8 1/4		M-type plug connector 		
VF5000 	3-position closed center VF3000  (A)4 2(B) (EA)5 1 3(EB) (P)	1/4 3/8		12 VDC 24 VDC 24 VAC 100 VAC 200 VAC 110 VAC 220 VAC 240 VAC	DIN terminal 	DC ■ With surge voltage suppressor ■ With light/surge voltage suppressor	Non-locking push type 
	3-position exhaust center VF3000  (A)4 2(B) (EA)5 1 3(EB) (P)					■ With surge voltage suppressor (Non-polar)	Push-turn locking slotted type 
	3-position pressure center VF5000  (A)4 2(B) (EA)5 1 3(EB) (P)						■ With light/surge voltage suppressor (Non-polar)
Base mounted	VF3000 	2-position single VF3000  (A)4 2(B) (EA)5 1 3(EB) (P)	1/4 3/8		DIN (EN1753 01-803) terminal 	AC ■ With light/surge voltage suppressor	Push-turn locking lever type 
		2-position double VF3000  (A)4 2(B) (EA)5 1 3(EB) (P)					
	VF5000 	3-position closed center VF3000  (A)4 2(B) (EA)5 1 3(EB) (P)	1/4 3/8 1/2		Conduit terminal 		
	3-position exhaust center VF3000  (A)4 2(B) (EA)5 1 3(EB) (P)						
	3-position pressure center VF5000  (A)4 2(B) (EA)5 1 3(EB) (P)						





Page 298

Page 312

Low wattage specification page 323 Power consumption: **0.35 W** (Without light) **0.4 W** (With light)

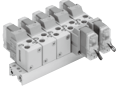
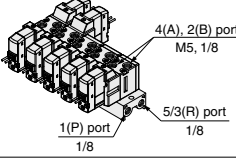
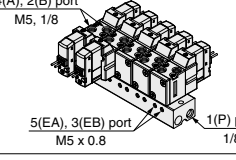
Model Selection by Operating Conditions 2

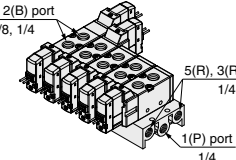
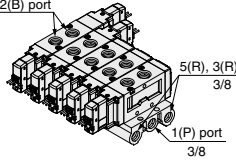
Solenoid Valve: Manifold

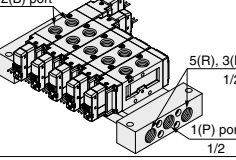
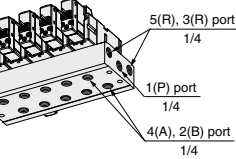
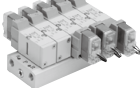
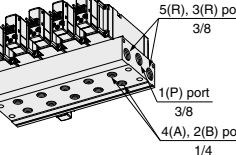
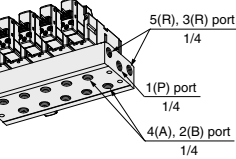
Series	EXH port type	Manifold base model	Applicable valve	Applicable stations
VF1000 	Common EXH	VV5F1-30  <p>4(A), 2(B) port M5, 1/8 1(P) port 1/8 5/3(R) port 1/8</p>	VF1□30 VF1□33	2 to 20 stations
	Individual EXH	VV5F1-31  <p>4(A), 2(B) port M5, 1/8 5(EA), 3(EB) port M5 x 0.8 1(P) port 1/8</p>		
VF3000 	Common EXH	VV5F3-30  <p>4(A), 2(B) port 1/8, 1/4 5(R), 3(R) port 1/4 1(P) port 1/4</p>	VF3□30 VF3□33	2 to 20 stations
	Common EXH	VV5F5-20  <p>4(A), 2(B) port 5(R), 3(R) port 3/8 1(P) port 3/8</p>		
VF5000 	Common EXH	VV5F5-21  <p>4(A), 2(B) port 5(R), 3(R) port 1/2 1(P) port 1/2</p>	VF5□20 VF5□23	2 to 15 stations
	Common EXH	VV5F3-40  <p>5(R), 3(R) port 1/4 1(P) port 1/4 4(A), 2(B) port 1/4</p>		
VF3000 	Common EXH	VV5F5-40  <p>5(R), 3(R) port 3/8 1(P) port 3/8 4(A), 2(B) port 1/4</p>	VF5□44	2 to 10 stations
	Common EXH	VV5F3-40  <p>5(R), 3(R) port 1/4 1(P) port 1/4 4(A), 2(B) port 1/4</p>		

Body ported

Base mounted

Page 327

Page 338

- SV
- SYJ
- SZ
- VF
- VP4
- VQ 1/2
- VQ 4/5
- VQC 1/2
- VQC 4/5
- VQZ
- SQ
- VFS
- VFR
- VQ7

Cylinder Speed Chart ①

Use as a guide for selection.
Please check the actual conditions with SMC Model Selection Program.

Body Ported

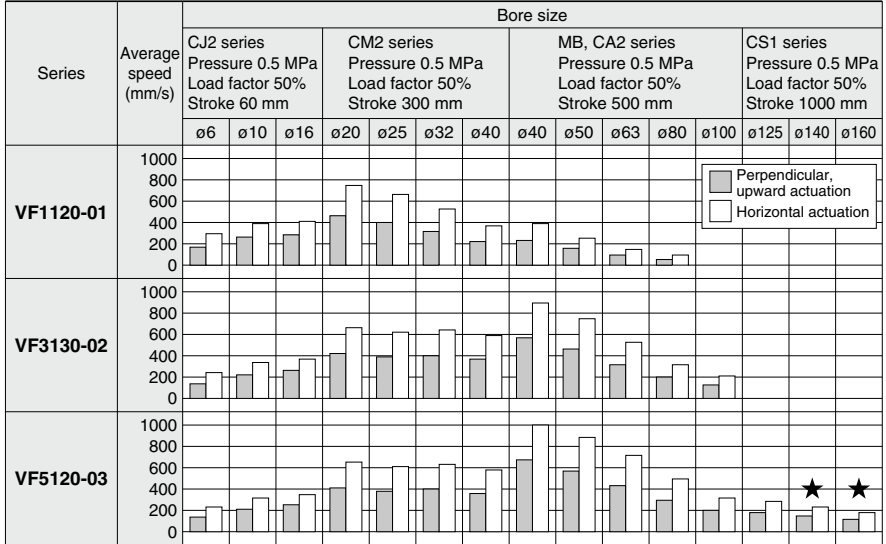

* With ★: when using steel piping

Base Mounted

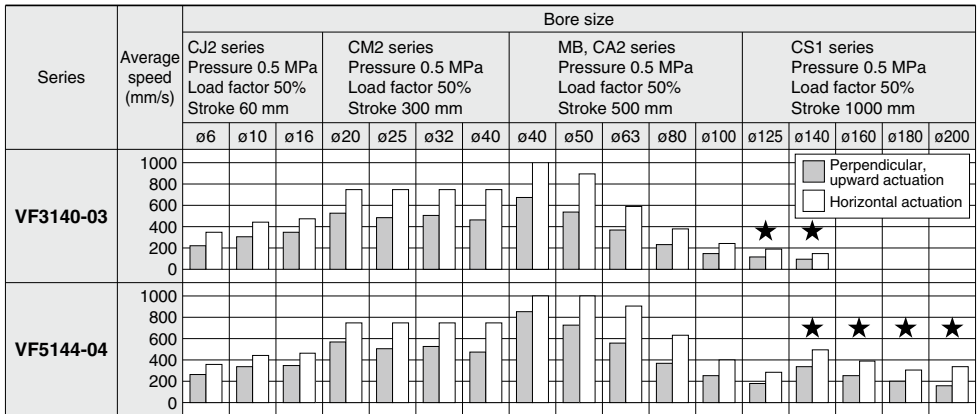

* With ★: when using steel piping

Cylinder Speed Chart ②

Use as a guide for selection.
Please check the actual conditions with SMC
Model Selection Program.

Conditions

Body Ported

	Body ported	CJ2 series	CM2 series	MB, CA2 series	CS1 series
VF1120-01	Tubing x Length	T0604 x 1 m	T0806 x 1 m		—
	Speed controller	AS3002F-06	AS3002F-08		—
	Silencer	AN101-01			—
VF3130-02	Tubing x Length	T0604 x 1 m	T1075 x 1 m		—
	Speed controller	AS3002F-06	AS4002F-10		—
	Silencer	AN110-01			—
VF5120-03	Tubing x Length	T0604 x 1 m	T1075 x 1 m	T1209 x 1 m	
	Speed controller	AS3002F-06	AS4002F-10	AS4002F-12	
	Silencer	AN30-03			AN302-03

Body Ported [when using SGP (Steel Piping)]

	Body ported	CS1 series
VF5120-03	Tubing x Length	SGP10A x 1 m
	Speed controller	AS420-03
	Silencer	AN30-03

Base Mounted

	Base mounted	CJ2 series	CM2 series	MB, CA2 series	CS1 series
VF3140-03	Tubing x Length	T0604 x 1 m	T1075 x 1 m	T1209 x 1 m	—
	Speed controller	AS3002F-06	AS4002F-10	AS4002F-12	—
	Silencer	AN30-03			—
VF5144-04	Tubing x Length	T0604 x 1 m	T1075 x 1 m	T1209 x 1 m	
	Speed controller	AS3002F-06	AS4002F-10	AS4002F-12	
	Silencer	AN40-04			

Base Mounted [when using SGP (Steel Piping)]

	Base mounted	CS1 series
VF3140-03	Tubing x Length	SGP10A x 1 m
	Speed controller	AS420-03
	Silencer	AN30-03
VF5144-04	Tubing x Length	SGP15A x 1 m
	Speed controller	AS420-04
	Silencer	AN40-04

SV

SYJ

SZ

VF

VP4

VQ

1/2

VQ

4/5

VQC

1/2

VQC

4/5

VQZ

SQ

VFS

VFR

VQ7

Pilot Operated 5 Port Solenoid Valve

VF1000/3000/5000 Series

Single Unit

Body Ported



Note) Only DIN and conduit terminal types are available with AC mode. Refer to the electrical entry for details.



How to Order Valve

Body ported VF 3 1 3 0 - 5 G 1-01

Series

1	VF1000
3	VF3000
5	VF5000

Type of actuation

1	2-position single
2	2-position double
3	3-position closed center
4	3-position exhaust center
5	3-position pressure center

* Only 1 and 2 are available with the VF1000.

Body model

Symbol	VF1000	VF3000	VF5000
2	○	○	○
3	○	○	○

Pressure specifications

Nil	Standard (0.7 MPa)
K	High-pressure type (1 MPa)

Body option

0: Pilot valve individual exhaust

PE port* EA/EB port

VF1000	VF3000	VF5000
○	○	○
○	○	○

3: Main/Pilot valve common exhaust

PE port EA/EB port

VF1000	VF3000	VF5000
○	○	○
○	○	○

Coil specifications

Nil	Standard
T	With power saving circuit (DC only)

Note) Be sure to select the power saving circuit type when it is continuously energized for long periods of time. (Refer to page 348 for details.)

* T type is available with DC mode only. When T is selected, only Z type of light/surge voltage suppressor is available. (Note that when the electrical entry of DIN terminal type without connector is selected, only DOS and YOS are available.)

Rated voltage

DC		AC (50/60 Hz)	
5	24 VDC	1	100 VAC
6	12 VDC	2	200 VAC
		3	110 VAC [115 VAC]
		4	220 VAC [230 VAC]
		7	240 VAC
		B	24 VAC

* Refer to "Made to Order" (Page 311) when piping to PE port is required.

Thread type

Nil	Rc
F	G
N	NPT
T	NPTF

* M5 is available with Nil only.

Bracket

Nil	Without bracket
F	With bracket

VF1000/3000 Single type
(The bracket cannot be connected after delivered.)

VF1000 Double type only

* Not available with the VF5000.

Made to Order

Nil	—
X500	Pilot exhaust port with piping thread (M3) specification (Refer to page 311.)
X600	TRIAC output specification (Refer to page 311.)

A, B port size

Symbol	Port size	VF1000	VF3000	VF5000
M5	M5 x 0.8	○	—	—
01	1/8	○	○	—
02	1/4	—	○	○
03	3/8	—	—	○

Electrical entry

Grommet	L-type plug connector	M-type plug connector	DIN terminal (IP65 compatible)	DIN (EN175301-803) terminal (IP65 compatible)	Conduit terminal (IP65 compatible)
G: Lead wire length 300 mm H: Lead wire length 600 mm	L: With lead wire (length 300 mm)	M: With lead wire (length 300 mm)	D: With connector	Y: With connector	T: Conduit terminal
G: Lead wire length 300 mm H: Lead wire length 600 mm DC Without light/surge voltage suppressor	LN: Without lead wire	MN: Without lead wire	DO: Without connector	YO: Without connector	
CE	DC	CE	CE	CE	CE
compliant	AC	—	—	—	—

Manual override

Nil: Non-locking push type	D: Push-tum locking slotted type	E: Push-tum locking lever type

Light/Surge voltage suppressor

Symbol	Light/Surge voltage suppressor	DC	AC
Nil	Without light/surge voltage suppressor	○	○
S	With surge voltage suppressor	○	—(Not)
Z	With light/surge voltage suppressor	○	○
R	With surge voltage suppressor (Non-polar)	○	—
U	With light/surge voltage suppressor (Non-polar)	○	—

Note) S type is not available with AC mode, since a rectifier prevents surge voltage generation.

* In the DIN terminal type, since a light is installed in the connector, DOZ, DOU, YOZ, YOU are not available.

Caution
When using the surge voltage suppressor type, residual voltage will remain. Refer to page 348 for details.

* LN and MN types are with 2 sockets.
* Refer to page 346 when different length of lead wire for L/M-type plug connector is required.
* Refer to page 347 for details on the DIN (EN175301-803) terminal.
Note 1) When using IP65, select the main/pilot valve common exhaust type. (Except VF1000)
Note 2) With the same specifications as the DC type, all electrical entries for the 24 VAC type are CE marking compliant.



Pilot Operated 5 Port Solenoid Valve Body Ported/Single Unit **VF1000/3000/5000 Series**

Specifications

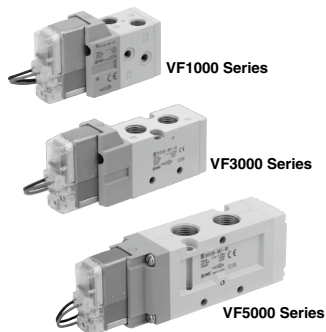

Model		VF1000	VF3000	VF5000
Fluid		Air		
Operating pressure range (MPa)	Standard	2-position single/3-position	0.15 to 0.7	
		2-position double	0.1 to 0.7	
	High-pressure type	2-position single/3-position	0.15 to 1.0	
		2-position double	0.1 to 1.0	
Ambient and fluid temperature (°C)		-10 to 50 (No freezing)		
Max. operating frequency (Hz)	2-position single/double	10	10	5
	3-position	—	3	3
Manual override		Non-locking push type Push-turn locking slotted type Push-turn locking lever type		
Pilot exhaust type		Individual exhaust, Main/Pilot valve common exhaust (Except VF1000)		
Lubrication		Not required		
Mounting orientation		Unrestricted		
Impact/Vibration resistance (m/s²) <small>(Note)</small>		300/50		
Enclosure		Dustproof (IP65* for D, Y, T)		

Note) Impact resistance: No malfunction occurred when it is tested in the axial direction and at the right angles to the main valve and armature in both energized and de-energized states every once for each condition. (Values at the initial period)

Vibration resistance: No malfunction occurred in a one-sweep test between 45 and 2000 Hz. Test was performed at both energized and de-energized states in the axial direction and at the right angles to the main valve and armature. (Values at the initial period)

* Based on IEC 60529. When using IP65, select the main/pilot valve common exhaust type.



Made to Order
(Refer to page 311 for details.)

Symbol	Specification
X500	Pilot exhaust port with piping thread (M3) specification
X600	TRIAC output specification

Solenoid Specifications

Electrical entry		Grommet (G), (H) L-type plug connector (L) M-type plug connector (M) G, H, L, M	DIN terminal (D) DIN (EN175301-803) terminal (Y) Conduit terminal (T) D, Y, T	
Coil rated voltage (V)	DC	24, 12		
	AC (50/60 Hz)	24, 100, 110, 200, 220, 240		
Allowable voltage fluctuation		±10% of rated voltage*		
Power consumption (W)	DC	Standard	1.5 (With light: 1.55)	1.5 (With light: 1.75)
		With power saving circuit	0.55 <small>(Note)</small> (With light only) (Starting 1.55 Holding 0.55)	0.75 <small>(Note)</small> (With light only) (Starting 1.75 Holding 0.75)
Apparent power (VA)*	AC	24 V	1.5 (With light: 1.55)	1.5 (With light: 1.75)
		100 V	1.55 (With light: 1.65)	1.55 (With light: 1.7)
		110 V [115 V]		
		200 V		
		220 V [230 V]		
240 V				
Surge voltage suppressor		Diode (Non-polar type: Varistor)		
Indicator light		LED (Neon light is used for AC mode of D, Y, T.)		

* It is in common between 110 VAC and 115 VAC, and between 220 VAC and 230 VAC.
 * Allowable voltage fluctuation is -15% to +5% of the rated voltage for 115 VAC or 230 VAC.
 * Since voltage drops due to the internal circuit in S, Z, T types (with power saving circuit), the allowable voltage fluctuation should be within the following range.
 24 VDC: -7% to +10% 12 VDC: -4% to +10%
 Note) Refer to page 348 for details.

Response Time

Series	Type of actuation	Pressure specifications	Operating pressure range (MPa)	Response time (ms) (at 0.5 MPa)			
				Without light/surge voltage suppressor	With light/surge voltage suppressor		AC
					S, Z type	R, U type	
VF1000	2-position	Standard	0.15 to 0.7	20	45	23	45
			0.1 to 0.7	12	12	12	12
		High-pressure type	0.15 to 1.0	23	48	26	48
			0.1 to 1.0	15	15	15	15
VF3000	2-position	Standard	0.15 to 0.7	20	45	23	45
			0.1 to 0.7	12	12	12	12
	3-position	0.15 to 0.7	30	55	33	55	
		0.15 to 1.0	23	48	26	48	
	2-position	High-pressure type	0.1 to 1.0	15	15	15	15
			0.15 to 1.0	33	58	36	58
VF5000	2-position	Standard	0.15 to 0.7	30	55	33	55
			0.1 to 0.7	15	15	15	15
	3-position	0.15 to 0.7	50	75	53	75	
		0.15 to 1.0	33	58	36	58	
	2-position	High-pressure type	0.1 to 1.0	18	18	18	18
			0.15 to 1.0	53	78	56	78

Note) Based on dynamic performance test, JIS B 8419: 2010. (Coil temperature: 20°C, at rated voltage)

VF1000/3000/5000 Series

Flow Rate Characteristics/Weight

Valve model	Type of actuation		Port size		Flow rate characteristics ^{Note 1)}						Weight (g) ^{Note 2)}	
			1, 4, 2 (P, A, B)	5, 3 (EA, EB)	1 → 4/2 (P → A/B)			4/2 → 5/3 (A/B → EA/EB)			Grommet	DIN terminal
					C [dm ³ / (s·bar)]	b	Cv	C [dm ³ / (s·bar)]	b	Cv		
VF1□20-M5	2- position	Single	M5 x 0.8		0.49	0.40	0.13	0.52	0.35	0.13	140	176
		Double			0.49	0.40	0.13	0.52	0.35	0.13	200	272
VF1□20-01	2- position	Single	1/8	M5 x 0.8	0.76	0.22	0.17	0.53	0.28	0.13	136	172
		Double			0.76	0.22	0.17	0.53	0.28	0.13	196	268
VF3□30-01	2- position	Single	1/8		3.0	0.38	0.78	2.8	0.30	0.67	182	218
		Double			3.0	0.38	0.78	2.8	0.30	0.67	243	315
	Closed center	2.4			0.31	0.64	1.8	0.37	0.46	260	332	
	Exhaust center	2.6			0.37	0.70	3.0 [2.5]	0.32 [0.28]	0.76 [0.62]	260	332	
	Pressure center	3.0 [1.4]			0.42 [0.44]	0.83 [0.39]	2.4	0.27	0.59	260	332	
	3- position	Exhaust center										
VF3□30-02	2- position	Single	1/4	1/8	4.0	0.36	1.0	3.1	0.32	0.75	178	214
		Double			4.0	0.36	1.0	3.1	0.32	0.75	239	311
	Closed center	2.4			0.45	0.68	1.9	0.37	0.47	256	328	
	Exhaust center	3.0			0.42	0.82	3.1 [2.7]	0.36 [0.29]	0.79 [0.66]	256	328	
	Pressure center	5.5 [1.4]			0.37 [0.50]	1.4 [0.40]	2.6	0.32	0.64	256	328	
	3- position	Exhaust center										
VF5□20-02	2- position	Single	1/4		7.1	0.46	1.9	7.7	0.51	2.2	313	349
		Double			7.1	0.46	1.9	7.7	0.51	2.2	368	440
	Closed center	6.7			0.46	1.8	6.6	0.41	1.8	406	478	
	Exhaust center	7.1			0.42	1.9	8.0 [7.4]	0.45 [0.47]	2.2 [2.1]	406	478	
	Pressure center	6.8 [2.7]			0.51 [0.50]	2.0 [0.78]	5.7	0.37	1.4	406	478	
	3- position	Exhaust center										
VF5□20-03	2- position	Single	3/8		8.8	0.44	2.4	10.0	0.49	2.9	299	335
		Double			8.8	0.44	2.4	10.0	0.49	2.9	354	426
	Closed center	7.5			0.43	2.0	7.5	0.38	1.9	391	463	
	Exhaust center	8.3			0.40	2.2	10.0 [8.7]	0.48 [0.46]	3.0 [2.4]	391	463	
	Pressure center	9.2 [3.0]			0.50 [0.49]	2.6 [0.85]	6.1	0.35	1.6	391	463	
	3- position	Exhaust center										

Note 1) [] : Normal position
 Note 2) Values without bracket

Construction: Body Ported

2-position single

Symbol
2-position single
VF1000



VF3000
VF5000



VF1000

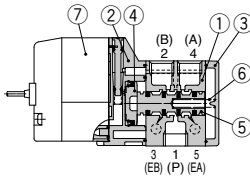

VF3000/5000

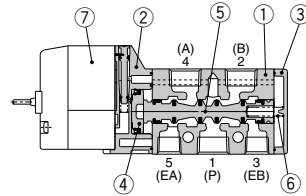

2-position double

Symbol
2-position single
VF1000

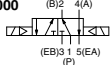

VF3000
VF5000

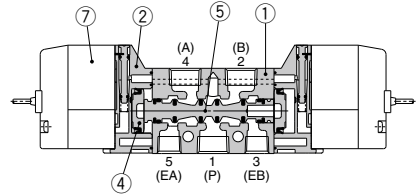
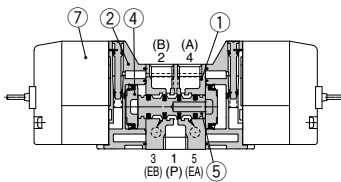

3-position closed center/exhaust center/pressure center

Symbol
3-position closed center



3-position exhaust center

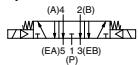

3-position pressure center

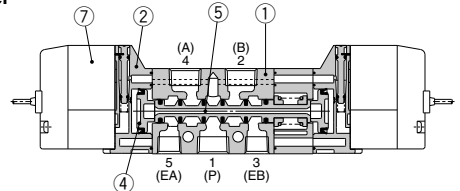

(Drawing shows a closed center type.)

Component Parts

No.	Description	Material	Note
1	Body	Aluminum die-casted	White
2	Adapter plate	Resin	Gray
3	End plate	Resin (VF313□-F : Aluminum die-casted)	White
4	Piston	Resin	
5	Spool valve	Aluminum, HNBR	
6	Spring	Stainless steel	

Replacement Parts

No.	Description	Part no.	Note
7	Pilot valve assembly	Refer to "How to Order Pilot Valve Assembly" on page 302.	Built-in strainer

Bracket Assembly Part No.

Description	Part no.
Bracket (for VF1000 double)	DXT144-8-1A (With 2 mounting screws)

SV
SYJ
SZ
VF
VP4
VQ 1/2
VQ 4/5
VQC 1/2
VQC 4/5
VQZ
SQ
VFS
VFR
VQ7

VF1000/3000/5000 Series

How to Order Pilot Valve Assembly (With a gasket and two mounting screws)

⚠ Caution

When only the pilot valve assembly is replaced, it is not possible to change from V211 (Grommet or L/M-type) to V212 (DIN or Conduit type), or vice versa.

Valve model: VF□□□□□□ - 5 G Z □ 1 - □□□□

* Select from the below in accordance with the valve used.

■ Grommet or L/M-type

V 2 1 1 □□ - 5 G Z

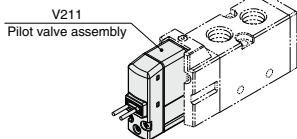

● Light/Surge voltage suppressor

		DC	AC
Nil	Without light/surge voltage suppressor	○	○
S	With surge voltage suppressor	○	—(Note)
Z	With light/surge voltage suppressor	○	○
R	With surge voltage suppressor (Non-polar)	○	—
U	With light/surge voltage suppressor (Non-polar)	○	—

Note) S type is not available with AC mode, since a rectifier prevents surge voltage generation. When T is selected, only Z type of light/surge voltage suppressor is available.

⚠ Caution

When using the surge voltage suppressor type, residual voltage will remain. Refer to page 348 for details.

● Electrical entry

G	Grommet (Lead wire length 300 mm)	
H	Grommet (Lead wire length 600 mm)	
L	L-type plug connector	With lead wire
LN		Without lead wire
LO	Without connector	
M	M-type plug connector	With lead wire
MN		Without lead wire
MO		Without connector

* LN and MN types are with 2 sockets.

* Refer to page 346 when different length of lead wire for L/M-type plug connector is required.

■ DIN or Conduit type

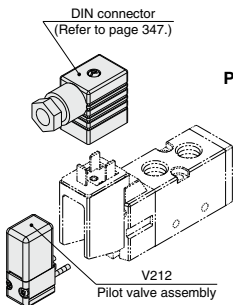

V 2 1 2 □□ - 5

● Pressure specifications

Nil	Standard (0.7 MPa)
K	High-pressure type (1 MPa)

● Coil specifications

Nil	Standard
T	With power saving circuit (DC only)

* T type is available with DC mode only.

● Rated voltage

DC	
5	24 VDC
6	12 VDC

AC (50/60 Hz)

1	100 VAC
2	200 VAC
3	110 VAC [115 VAC]
4	220 VAC [230 VAC]
7	240 VAC
B	24 VAC

⚠ Caution

For V212 (DIN or Conduit type), the coil specifications (DIN and voltage (including light/surge voltage suppressor) cannot be changed by replacing the pilot valve assembly.

⚠ Caution

Tightening torque of the pilot valve assembly mounting screw
M2.5: 0.32 N·m

Pilot Operated 5 Port Solenoid Valve Body Ported/Single Unit **VF1000/3000/5000 Series**

Dimensions: VF1000 Series/Body Ported

2-position single

Grommet (G) (H): VF1120-□^G□□1-M5□(-F)

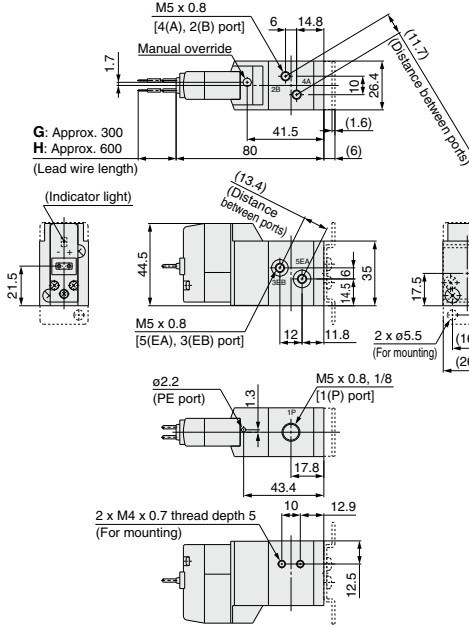

Grommet (G) (H): VF1120-□^G□□1-01□(-F)

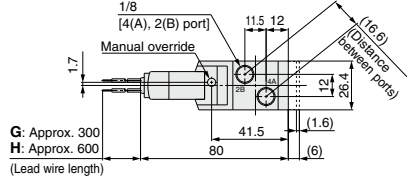

Grommet (G) (H)
DC without light/surge voltage suppressor

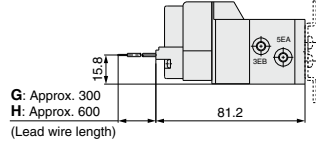

L-type plug connector (L): VF1120-□L□□1-M5₀₁□(-F)

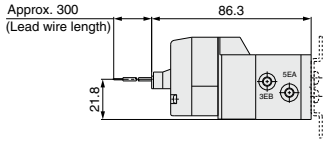

Unless otherwise indicated, dimensions are the same as Grommet (G).

DIN terminal (D) (Y): VF1120-□D□□1-M5₀₁□(-F)

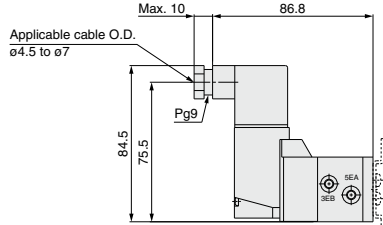

Unless otherwise indicated, dimensions are the same as Grommet (G).

M-type plug connector (M): VF1120-□M□□1-M5₀₁□(-F)

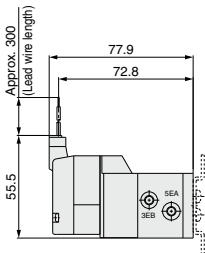

Unless otherwise indicated, dimensions are the same as Grommet (G).

Conduit terminal (T): VF1120-□T□□1-M5₀₁□(-F)

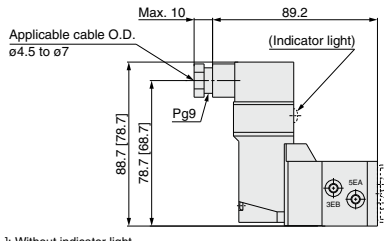

[]: Without indicator light
Unless otherwise indicated, dimensions are the same as Grommet (G).

SV
SYJ
SZ
VF
VP4
VQ 1/2
VQ 4/5
VQC 1/2
VQC 4/5
VQZ
SQ
VFS
VFR
VQ7

VF1000/3000/5000 Series

Dimensions: VF1000 Series/Body Ported

2-position double

Grommet (G) (H): VF1220-□^G□□1-M5□

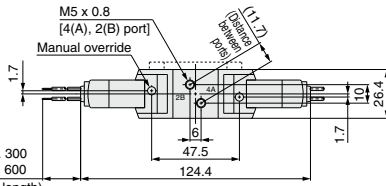

G: Approx. 300
H: Approx. 600
(Lead wire length)

Grommet (G) (H): VF1220-□^G□□1-01□

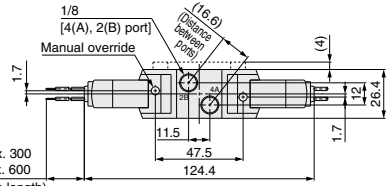

G: Approx. 300
H: Approx. 600
(Lead wire length)

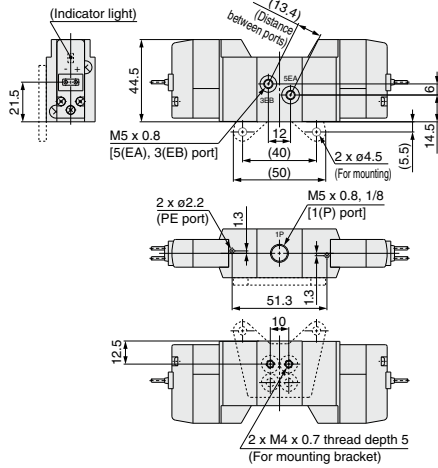

Grommet (G) (H)
DC without light/surge voltage suppressor

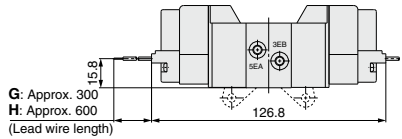

G: Approx. 300
H: Approx. 600
(Lead wire length)

L-type plug connector (L): VF1220-□^L□□1-M5□

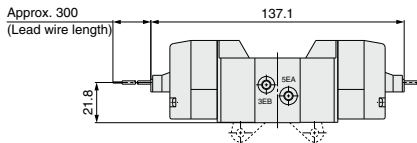

Approx. 300
(Lead wire length)

DIN terminal (D) (Y): VF1220-□^D□□1-M5□

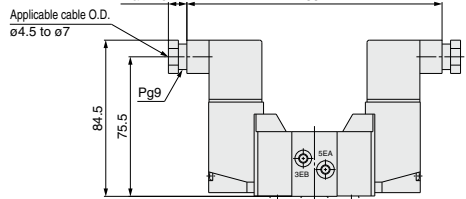

Applicable cable O.D.
ø4.5 to ø7

Unless otherwise indicated, dimensions are the same as Grommet (G).

M-type plug connector (M): VF1220-□^M□□1-M5□

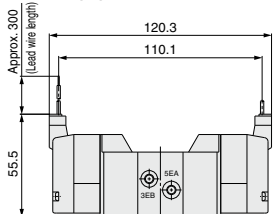

Approx. 300
(Lead wire length)

Conduit terminal (T): VF1220-□^T□□1-M5□

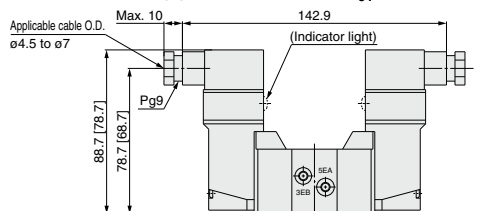

Applicable cable O.D.
ø4.5 to ø7

[]: Without indicator light
Unless otherwise indicated, dimensions are the same as Grommet (G).

Unless otherwise indicated, dimensions are the same as Grommet (G).

Dimensions: VF3000 Series/Body Ported

2-position single

Grommet (G) (H): VF3130-□_G□_H□□1.01□□ (-F)

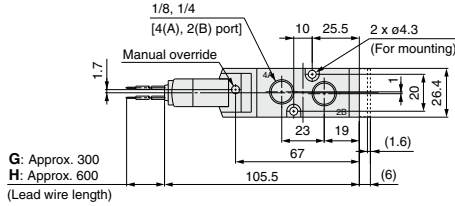

G: Approx. 300
H: Approx. 600

(Lead wire length)

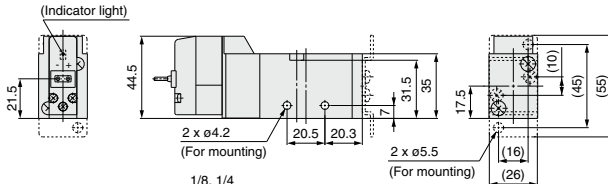

Grommet (G) (H)

DC without light/surge voltage suppressor

G: Approx. 300
H: Approx. 600
(Lead wire length)

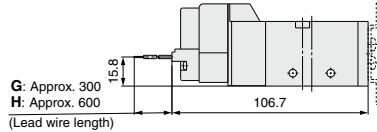

L-type plug connector (L): VF3130-□L□□1.01□□ (-F)

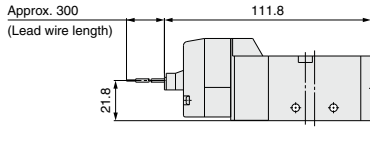

Unless otherwise indicated, dimensions are the same as Grommet (G).

DIN terminal (D) (Y): VF3130-□_D□□1.01□□ (-F)

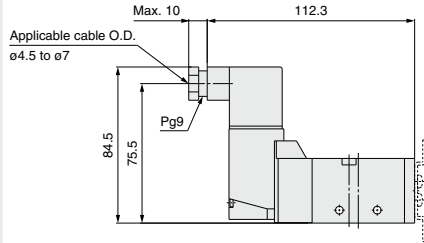

Unless otherwise indicated, dimensions are the same as Grommet (G).

M-type plug connector (M): VF3130-□M□□1.01□□ (-F)

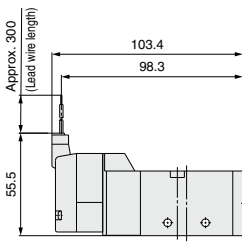

Unless otherwise indicated, dimensions are the same as Grommet (G).

Conduit terminal (T): VF3130-□T□□1.01□□ (-F)

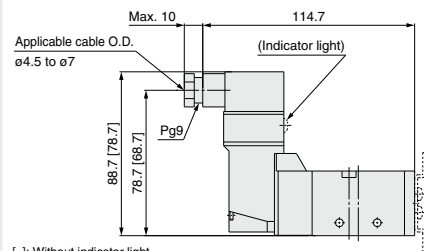

[]: Without indicator light

Unless otherwise indicated, dimensions are the same as Grommet (G).

SV
SYJ
SZ
VF
VP4
VQ 1/2
VQ 4/5
VQC 1/2
VQC 4/5
VQZ
SQ
VFS
VFR
VQ7

VF1000/3000/5000 Series

Dimensions: VF3000 Series/Body Ported

2-position double

Grommet (G) (H): VF3230-□_G□□1-01□_H

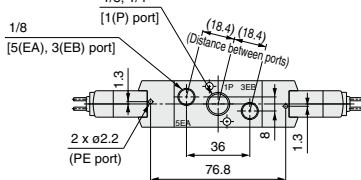
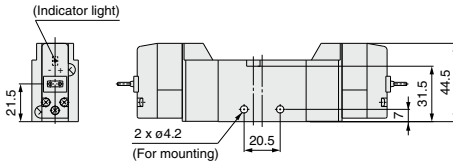
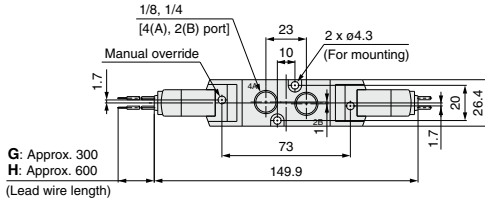

Grommet (G) (H)

DC without light/surge voltage suppressor

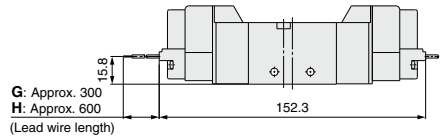

L-type plug connector (L): VF3230-□L□□1-01□_D

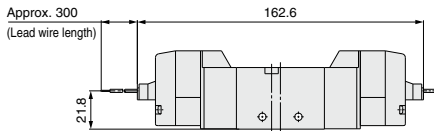

Unless otherwise indicated, dimensions are the same as Grommet (G).

M-type plug connector (M): VF3230-□M□□1-01□_D

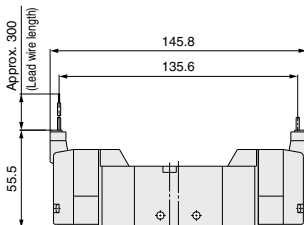

Unless otherwise indicated, dimensions are the same as Grommet (G).

DIN terminal (D) (Y): VF3230-□_D□□1-01□_D

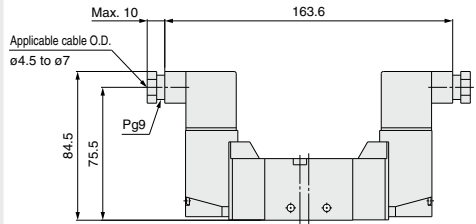

Unless otherwise indicated, dimensions are the same as Grommet (G).

Conduit terminal (T): VF3230-□T□□1-01□_D

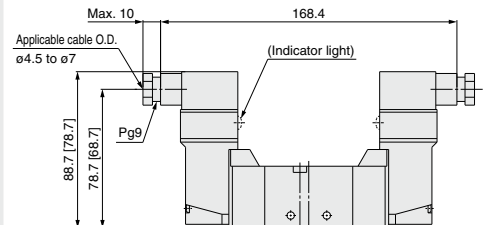

[]: Without indicator light

Unless otherwise indicated, dimensions are the same as Grommet (G).

Dimensions: VF3000 Series/Body Ported

3-position closed center/exhaust center/pressure center

Grommet (G) (H): VF3³₅30-□□□□1-01□□

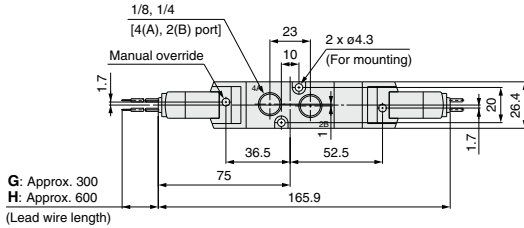

G: Approx. 300
 H: Approx. 600
 (Lead wire length)

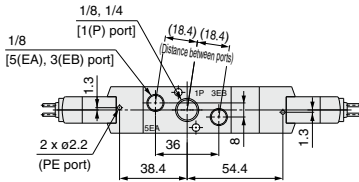
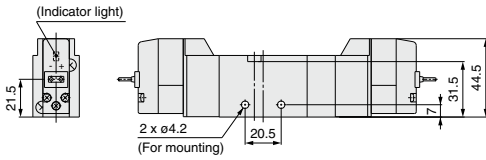

Grommet (G) (H)
 DC without light/surge voltage suppressor

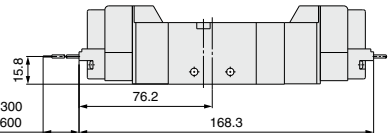

G: Approx. 300
 H: Approx. 600
 (Lead wire length)

L-type plug connector (L): VF3³₅30-□□□□1-01□□

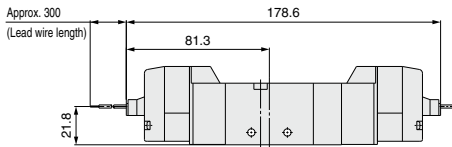

Unless otherwise indicated, dimensions are the same as Grommet (G).

M-type plug connector (M): VF3³₅30-□□□□1-01□□

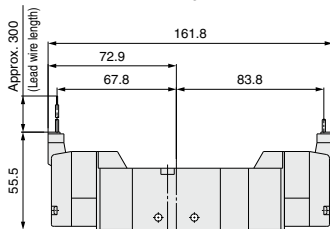

Unless otherwise indicated, dimensions are the same as Grommet (G).

DIN terminal (D) (Y): VF3³₅30-□□□□1-01□□

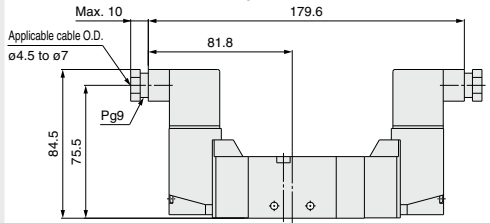

Unless otherwise indicated, dimensions are the same as Grommet (G).

Conduit terminal (T): VF3³₅30-□□□□1-01□□

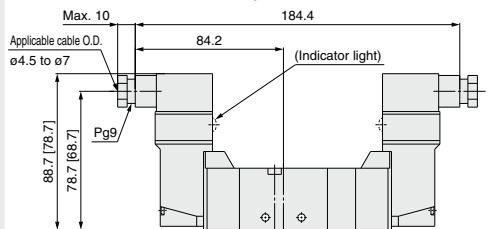

[]: Without indicator light
 Unless otherwise indicated, dimensions are the same as Grommet (G).

SV
SYJ
SZ
VF
VP4
VQ 1/2
VQ 4/5
VQC 1/2
VQC 4/5
VQZ
SQ
VFS
VFR
VQ7

VF1000/3000/5000 Series

Dimensions: VF5000 Series/Body Ported

2-position single

Grommet (G) (H): VF5120-□^G□□□1-02□₀₃□

G: Approx. 300

H: Approx. 600

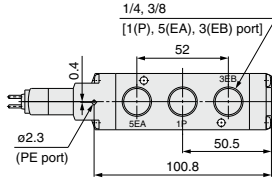
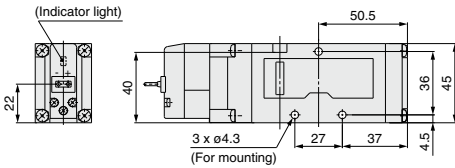
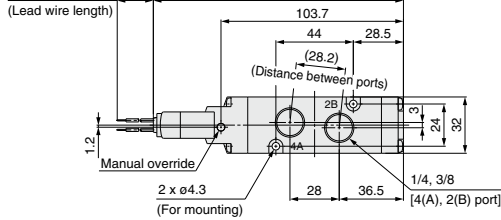

Grommet (G) (H)

DC without light/surge voltage suppressor

G: Approx. 300

H: Approx. 600

(Lead wire length)

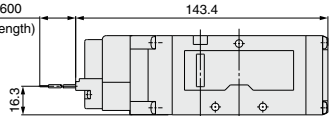

L-type plug connector (L): VF5120-□L□□1-02□₀₃□

Approx. 300

(Lead wire length)

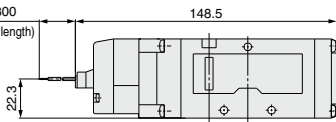

Unless otherwise indicated, dimensions are the same as Grommet (G).

DIN terminal (D) (Y): VF5120-□^D□□□1-02□₀₃□

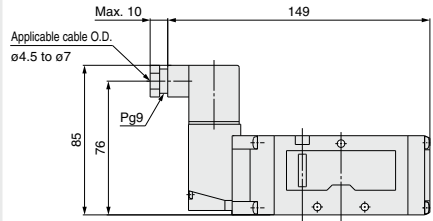

Unless otherwise indicated, dimensions are the same as Grommet (G).

M-type plug connector (M): VF5120-□M□□1-02□₀₃□

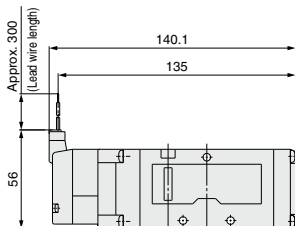

Unless otherwise indicated, dimensions are the same as Grommet (G).

Conduit terminal (T): VF5120-□T□□1-02□₀₃□

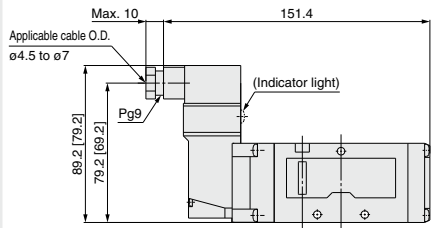

[]: Without indicator light

Unless otherwise indicated, dimensions are the same as Grommet (G).

Dimensions: VF5000 Series/Body Ported

2-position double

Grommet (G) (H): VF5220-□^G□□1-02₀₃□

G: Approx. 300

H: Approx. 600

(Lead wire length)

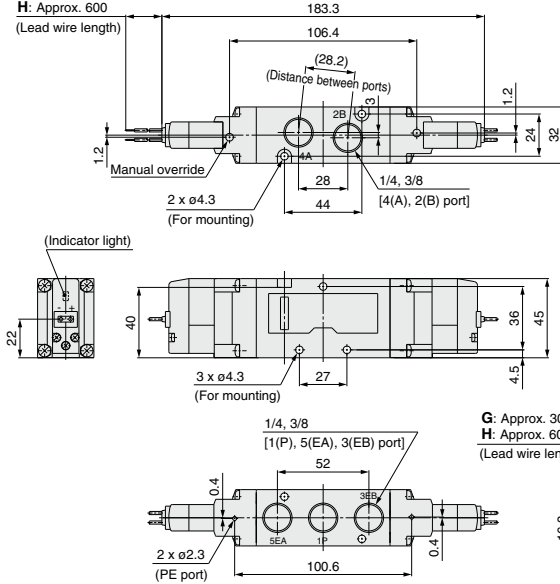

Grommet (G) (H)
DC without light/surge voltage suppressor

G: Approx. 300

H: Approx. 600

(Lead wire length)

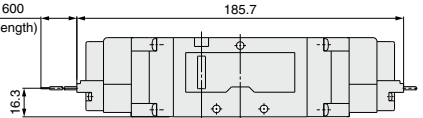

L-type plug connector (L): VF5220-□L□□1-02₀₃□

Approx. 300

(Lead wire length)

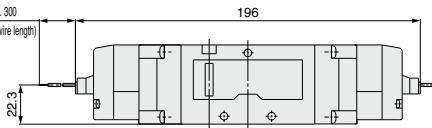

Unless otherwise indicated, dimensions are the same as Grommet (G).

M-type plug connector (M): VF5220-□M□□1-02₀₃□

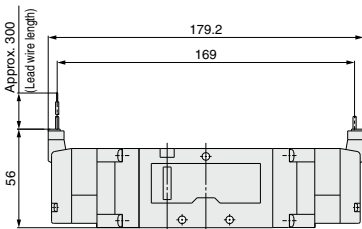

Unless otherwise indicated, dimensions are the same as Grommet (G).

DIN terminal (D) (Y): VF5220-□^D□□1-02₀₃□

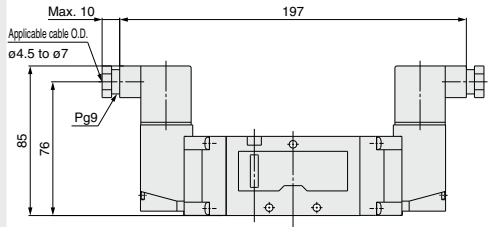

Unless otherwise indicated, dimensions are the same as Grommet (G).

Conduit terminal (T): VF5220-□T□□1-02₀₃□

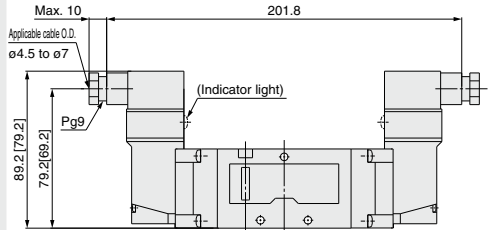

[]: Without indicator light

Unless otherwise indicated, dimensions are the same as Grommet (G).

SV
SYJ
SZ
VF
VP4
VQ 1/2
VQ 4/5
VQC 1/2
VQC 4/5
VQZ
SQ
VFS
VFR
VQ7

VF1000/3000/5000 Series

Dimensions: VF5000 Series/Body Ported

3-position closed center/exhaust center/pressure center

Grommet (G) (H): VF5³₅20-□^G□□1-⁰²₀₃□

G: Approx. 300

H: Approx. 600

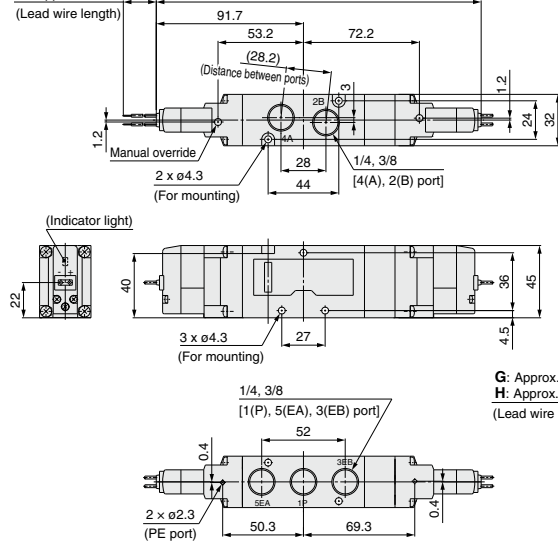

Grommet (G) (H)

DC without light/surge voltage suppressor

G: Approx. 300

H: Approx. 600

(Lead wire length)

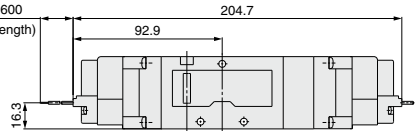

L-type plug connector (L): VF5³₅20-□L□□1-⁰²₀₃□

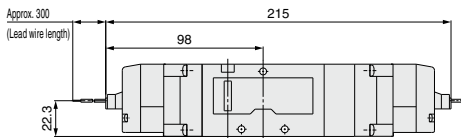

Unless otherwise indicated, dimensions are the same as Grommet (G).

M-type plug connector (M): VF5³₅20-□M□□1-⁰²₀₃□

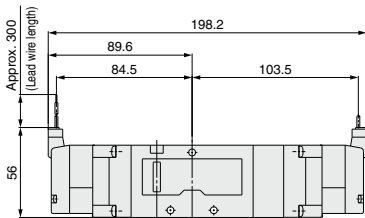

Unless otherwise indicated, dimensions are the same as Grommet (G).

310

DIN terminal (D) (Y): VF5³₅20-□^D□□1-⁰²₀₃□

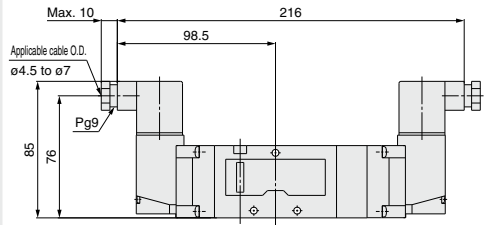

Unless otherwise indicated, dimensions are the same as Grommet (G).

Conduit terminal (T): VF5³₅20-□T□□1-⁰²₀₃□

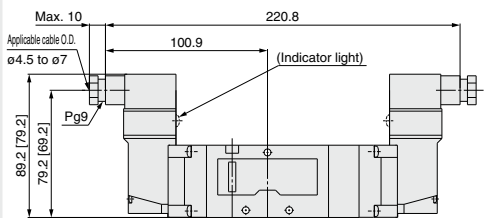

[]: Without indicator light

Unless otherwise indicated, dimensions are the same as Grommet (G).

VF1000/3000/5000 Series

Made to Order

Please contact SMC for detailed dimensions, specifications and lead times.



1 Body Ported Pilot Exhaust Port with Piping Thread (M3) Specification

In this specification, piping to the pilot exhaust port (PE port) is available when the valve is used in an environment where the exhaust from the pilot valve is not allowable, or intrusion of ambient dust should be prevented. Combination with low wattage specification is not possible.

How to Order Valve

VF 3 **3 0** **1** **X500**

Series

1	VF1000
3	VF3000
5	VF5000

Type of actuation

1	2-position single
2	2-position double
3	3-position closed center
4	3-position exhaust center
5	3-position pressure center

• Entry is the same as standard products. The specifications and performance are the same as those of standard products.

• Body model

Symbol	VF1000	VF3000	VF5000
2	○	—	○
3	—	○	—

Note) Not available for the base mounted type.

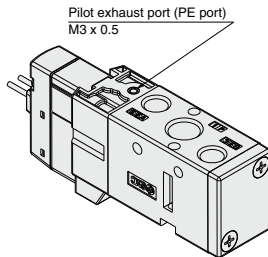

• 2-position single

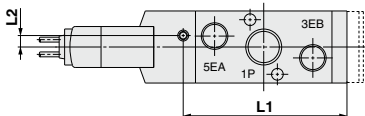

• 2-position double

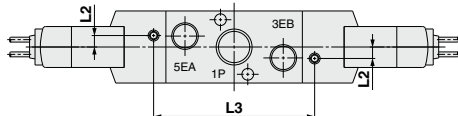

• 3-position closed center/exhaust center/pressure center

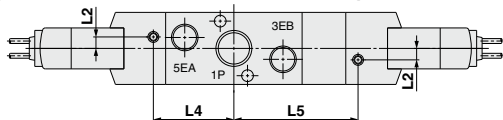

Series	L1	L2	L3	L4	L5
VF1000	34.5	4.2	33.4	—	—
VF3000	60	4.2	59	29.5	45.5
VF5000	95	3.45	89	44.5	63.5

2 TRIAC Output Specification

For AC type valve, use this specification when the pilot valve is not recovered even though valve power supply is turned OFF at the equipment using output unit with large leakage valve over 8% of the rated voltage (TRIAC output such as PLC or SSR, etc.). Combination with low wattage specification is not possible.

How to Order Valve

VF 3 **1** **X600**

Series

1	VF1000
3	VF3000
5	VF5000

Type of actuation

1	2-position single
2	2-position double
3	3-position closed center
4	3-position exhaust center
5	3-position pressure center

• Entry is the same as standard products.
Note) Rated voltage: AC type only

Pilot Operated 5 Port Solenoid Valve

VF3000/5000 Series

Single Unit

Base Mounted



Note) Only DIN and conduit terminal types are available with AC mode. Refer to the electrical entry for details.



How to Order Valve

Base mounted (VF1000: Not available) **VF 3 1 4 0 K T - 5 G Z D 1 - 02** -

Series

3	VF3000
5	VF5000

* Not available with the VF1000.

Type of actuation

1	2-position single
2	2-position double
3	3-position closed center
4	3-position exhaust center
5	3-position pressure center

Body model

Body option

0: Pilot valve individual exhaust	
VF3000	VF5000
<input type="checkbox"/>	<input type="checkbox"/>
3: Main/Pilot valve common exhaust	
VF3000	VF5000
<input type="checkbox"/>	<input type="checkbox"/>
4: Pilot valve base exhaust	
VF3000	VF5000
<input type="checkbox"/>	<input type="checkbox"/>

Pressure specifications

Nil	Standard (0.7 MPa)
K	High-pressure type (1 MPa)

Coil specifications

Nil	Standard
T	With power saving circuit (DC only)

Note) Be sure to select the power saving circuit type when it is continuously energized for long periods of time. (Refer to page 348 for details.)

* T type is available with DC mode only. When T is selected, only Z type of light/surge voltage suppressor is available. (Note that when the electrical entry of DIN terminal type without connector is selected, only DOS and YOS are available.)

Rated voltage

DC	AC (50/60 Hz)
5	1 100 VAC
	2 200 VAC
	3 110 VAC [115 VAC]
	4 220 VAC [230 VAC]
	7 240 VAC
6	B 24 VAC

Made to Order

Nil	—
X600	TRIAC output specification (Refer to page 311.)

Thread type

Nil	Rc
F	G
N	NPT
T	NPTF

Port size (Sub-plate)

Symbol	Port size	VF3000	VF5000
Nil	Without sub-plate		
02	1/4	<input type="checkbox"/>	<input type="checkbox"/>
03	3/8	<input type="checkbox"/>	<input type="checkbox"/>
04	1/2	<input type="checkbox"/>	<input type="checkbox"/>

* Without the sub-plate, two mounting screws and a gasket are included.

Manual override

Nil: Non-locking push type	D: Push-tum locking slotted type	E: Push-tum locking lever type

Light/Surge voltage suppressor

Symbol	Light/Surge voltage suppressor	DC	AC
Nil	Without light/surge voltage suppressor	<input type="checkbox"/>	<input type="checkbox"/>
S	With surge voltage suppressor	<input type="checkbox"/>	<input type="checkbox"/>
Z	With light/surge voltage suppressor	<input type="checkbox"/>	<input type="checkbox"/>
R	With surge voltage suppressor (Non-polar)	<input type="checkbox"/>	<input type="checkbox"/>
U	With light/surge voltage suppressor (Non-polar)	<input type="checkbox"/>	<input type="checkbox"/>

Note) S type is not available with AC mode, since a rectifier prevents surge voltage generation.

* In the DIN terminal type, since a light is installed in the connector, DOZ, DOU, YOZ, YOU are not available.

Caution

When using the surge voltage suppressor type, residual voltage will remain. Refer to page 348 for details.

Electrical entry

Grommet	L-type plug connector	M-type plug connector	DIN terminal (IP65 compatible)	DIN (EN175301-803) terminal (IP65 compatible)	Conduit terminal (IP65 compatible)
G: Lead wire length 300 mm	L: With lead wire (length 300 mm)	M: With lead wire (length 300 mm)	D: With connector	Y: With connector	T: Conduit terminal
H: Lead wire length 600 mm					
G: Lead wire length 300 mm	LN: Without lead wire	MN: Without lead wire	DO: Without connector	YO: Without connector	
H: Lead wire length 600 mm					
DC Without light/surge voltage suppressor	LO: Without connector	MO: Without connector			
CE	DC	CE	CE	CE	CE
compliant	AC	—	—	—	—

* LN and MN types are with 2 sockets.

* Refer to page 346 when different length of lead wire for L/M-type plug connector is required.

* Refer to page 347 for details on the DIN (EN175301-803) terminal. Note 1) When using IP65, select the main/pilot valve common exhaust type or pilot valve base exhaust type.

Note 2) With the same specifications as the DC type, all electrical entries for the 24 VAC type are CE marking compliant.

Pilot Operated 5 Port Solenoid Valve Base Mounted/Single Unit **VF3000/5000 Series**

Specifications

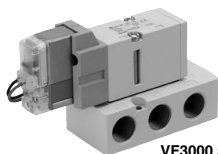

VF3000 Series



VF5000 Series



Made to Order
(Refer to page 311 for details.)

Symbol	Specification
X600	TRIAC output specification

Model		VF3000	VF5000
Fluid		Air	
Operating pressure range (MPa)	Standard	2-position single/3-position	0.15 to 0.7
		2-position double	0.1 to 0.7
	High-pressure type	2-position single/3-position	0.15 to 1.0
		2-position double	0.1 to 1.0
Ambient and fluid temperature (°C)		-10 to 50 (No freezing)	
Max. operating frequency (Hz)	2-position single/double	10	5
	3-position	3	3
Manual override		Non-locking push type Push-turn locking slotted type Push-turn locking lever type	
Pilot exhaust type		Individual exhaust, Main/ Pilot valve common exhaust	Pilot valve base exhaust
Lubrication		Not required	
Mounting orientation		Unrestricted	
Impact/Vibration resistance (m/s ²) <small>Note)</small>		300/50	
Enclosure		Dustproof (IP65* for D, Y, T)	

Note) Impact resistance: No malfunction occurred when it is tested in the axial direction and at the right angles to the main valve and armature in both energized and de-energized states every once for each condition. (Values at the initial period)

Vibration resistance: No malfunction occurred in a one-sweep test between 45 and 2000 Hz. Test was performed at both energized and de-energized states in the axial direction and at the right angles to the main valve and armature. (Values at the initial period)

* Based on IEC 60529. When using IP65, select the main/pilot valve common exhaust type or pilot valve base exhaust type.

Solenoid Specifications

Electrical entry		Grommet (G), (H) L-type plug connector (L) M-type plug connector (M) G, H, L, M	DIN terminal (D) DIN (EN175301-803) terminal (Y) Conduit terminal (T) D, Y, T
Coil rated voltage (V)	DC AC (50/60 Hz)	24, 12	
Allowable voltage fluctuation		±10% of rated voltage*	
Power consumption (W)	DC	Standard 1.5 (With light: 1.55) 0.55 ^{Note)} (With light only) [Starting 1.55 Holding 0.55]	1.5 (With light: 1.75) 0.75 ^{Note)} (With light only) [Starting 1.75 Holding 0.75]
	DC With power saving circuit	1.5 (With light: 1.55)	
Apparent power (VA)*	AC	24 V	1.5 (With light: 1.75)
		100 V	
		110 V [115 V]	1.55 (With light: 1.65)
		200 V	
		220 V [230 V]	1.55 (With light: 1.7)
240 V			
Surge voltage suppressor		Diode (Non-polar type: Varistor)	
Indicator light		LED (Neon light is used for AC mode of D, Y, T.)	

* It is in common between 110 VAC and 115 VAC, and between 220 VAC and 230 VAC.

* Allowable voltage fluctuation is -15% to +5% of the rated voltage for 115 VAC or 230 VAC.

* Since voltage drops due to the internal circuit in S, Z, T types (with power saving circuit), the allowable voltage fluctuation should be within the following range.

24 VDC: -7% to +10% 12 VDC: -4% to +10%

Note) Refer to page 348 for details.

Response Time

Series	Type of actuation	Pressure specifications	Operating pressure range (MPa)	Without light/surge voltage suppressor	Response time (ms) (at 0.5 MPa)		
					With light/surge voltage suppressor		AC
					S, Z type	R, U type	
VF1000	2-position	Standard	0.15 to 0.7	20	45	23	45
			0.1 to 0.7	12	12	12	12
		High-pressure type	0.15 to 1.0	23	48	26	48
			0.1 to 1.0	15	15	15	15
VF3000	2-position	Standard	0.15 to 0.7	20	45	23	45
			0.1 to 0.7	12	12	12	12
	3-position	Standard	0.15 to 0.7	30	55	33	55
			0.15 to 1.0	23	48	26	48
	2-position	High-pressure type	0.1 to 1.0	15	15	15	15
			0.15 to 1.0	33	58	36	58
VF5000	2-position	Standard	0.15 to 0.7	30	55	33	55
			0.1 to 0.7	15	15	15	15
	3-position	Standard	0.15 to 0.7	50	75	53	75
			0.15 to 1.0	33	58	36	58
	2-position	High-pressure type	0.1 to 1.0	18	18	18	18
			0.15 to 1.0	53	78	56	78

Note) Based on dynamic performance test, JIS B 8375-1981. (Coil temperature: 20°C, at rated voltage)

SV
SYJ
SZ
VF
VP4
VQ 1/2
VQ 4/5
VQC 1/2
VQC 4/5
VQZ
SQ
VFS
VFR
VQ7

VF3000/5000 Series

Flow Rate Characteristics/Weight

Valve model	Type of actuation		Port size	Flow rate characteristics <small>Note 1)</small>						Weight (g) <small>Note 2)</small>	
				1 → 4/2 (P → A/B)			4/2 → 5/3 (A/B → EA/EB)			Grommet	DIN terminal
				C [dm ³ /s-bar]	b	Cv	C [dm ³ /s-bar]	b	Cv		
VF3□40-02	2-position	Single	1/4	2.8	0.14	0.64	2.5	0.18	0.57	344 (192)	380 (228)
		Double		2.8	0.14	0.64	2.5	0.18	0.57	405 (252)	477 (324)
	3-position	Closed center		2.1	0.22	0.49	1.6	0.26	0.41	422 (270)	494 (342)
		Exhaust center		2.3	0.21	0.53	2.8 [2.1]	0.23 [0.26]	0.66 [0.50]	422 (270)	494 (342)
		Pressure center		2.9 [1.1]	0.16 [0.45]	0.67 [0.32]	2.1	0.23	0.49	422 (270)	494 (342)
VF3□40-03	2-position	Single	3/8	3.1	0.24	0.76	2.6	0.23	0.62	327 (192)	363 (228)
		Double		3.1	0.24	0.76	2.6	0.23	0.62	388 (252)	460 (324)
	3-position	Closed center		2.2	0.33	0.57	1.6	0.34	0.40	405 (270)	477 (342)
		Exhaust center		2.6	0.27	0.61	2.8 [2.3]	0.30 [0.28]	0.68 [0.55]	405 (270)	477 (342)
		Pressure center		3.4 [1.3]	0.29 [0.48]	0.80 [0.38]	2.2	0.31	0.52	405 (270)	477 (342)
VF5□44-02	2-position	Single	1/4	7.3	0.49	2.1	7.3	0.50	2.0	486 (297)	522 (333)
		Double		7.3	0.49	2.1	7.3	0.50	2.0	541 (352)	613 (424)
	3-position	Closed center		6.6	0.35	1.7	6.3	0.31	1.6	578 (390)	650 (462)
		Exhaust center		7.4	0.33	1.9	8.1 [7.4]	0.35 [0.34]	2.1 [1.9]	578 (390)	650 (462)
		Pressure center		8.0 [2.9]	0.35 [0.48]	2.1 [0.85]	5.6	0.31	1.5	578 (390)	650 (462)
VF5□44-03	2-position	Single	3/8	8.4	0.34	2.2	8.9	0.29	2.3	473 (297)	509 (333)
		Double		8.4	0.34	2.2	8.9	0.29	2.3	529 (352)	601 (424)
	3-position	Closed center		7.3	0.34	2.0	7.1	0.28	1.8	566 (390)	638 (462)
		Exhaust center		8.1	0.27	2.0	14.0 [8.3]	0.26 [0.31]	3.4 [2.2]	566 (390)	638 (462)
		Pressure center		8.1 [2.5]	0.33 [0.48]	2.0 [0.74]	5.7	0.31	1.4	566 (390)	638 (462)
VF5□44-04	2-position	Single	1/2	9.4	0.43	2.7	12.0	0.32	3.0	545 (297)	581 (333)
		Double		9.4	0.43	2.7	12.0	0.32	3.0	600 (352)	672 (424)
	3-position	Closed center		7.1	0.41	2.1	7.4	0.32	2.0	638 (390)	710 (462)
		Exhaust center		8.6	0.39	2.4	13.0 [8.9]	0.21 [0.40]	3.1 [2.5]	638 (390)	710 (462)
		Pressure center		11.0 [2.6]	0.18 [0.47]	2.6 [0.78]	6.1	0.35	1.6	638 (390)	710 (462)

Note 1) []: Normal position

Note 2) (): Values without sub-plate

Pilot Operated 5 Port Solenoid Valve **VF3000/5000 Series**

Construction: Base Mounted

VF3000/5000

Symbol
2-position single

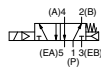

2-position single

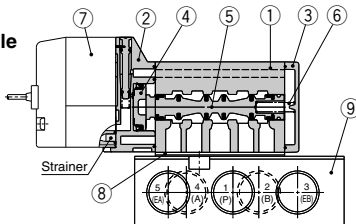

Symbol
2-position double

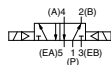

2-position double

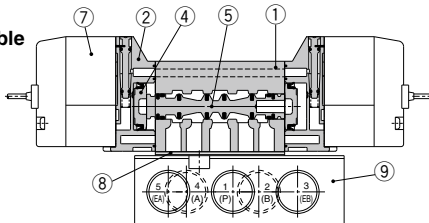

Symbol
3-position closed center



3-position closed center/exhaust center/pressure center

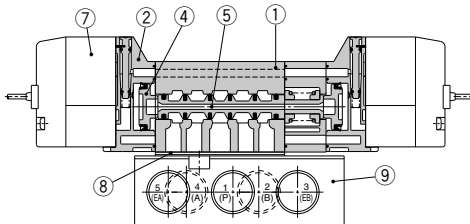

3-position exhaust center



3-position pressure center

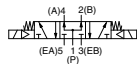

(Drawing shows a closed center type.)

Sub-plate part no.

VF 3 000-71-1

Series

3	VF3000
5	VF5000

Thread type

NII	Rc
F	G
N	NPT
T	NPTF

Port size

Symbol	Port size	VF3000	VF5000
1	1/4	○	○
2	3/8	○	○
3	1/2	—	○

Component Parts

No.	Description	Material	Note
1	Body	Aluminum die-casted	White
2	Adapter plate	Resin	Gray
3	End plate	Resin	White
4	Piston	Resin	
5	Spool valve	Aluminum, HNBR	
6	Spring	Stainless steel	

Replacement Parts

No.	Description	Part no.		Note
		VF3000	VF5000	
7	Pilot valve assembly	Refer to "How to Order Pilot Valve Assembly" on page 316.		Built-in strainer
8	Gasket	DXT031-30-11	DXT156-9-8	HNBR
9	Sub-plate	1/4: VF3000-71-1□ 3/8: VF3000-71-2□	1/4: VF5000-71-1□ 3/8: VF5000-71-2□ 1/2: VF5000-71-3□	Aluminum die-casted
—	Round head combination screw (1 pc.)	DXT031-44-1 (M4 x 39.5, With spring washer)	—	For mounting valve
—	Hexagon socket head cap screw (1 pc.)	—	AXT620-32-1 (M4 x 48, With spring washer)	For mounting valve

Caution

Tightening Torque for Mounting Valve

M4: 1.4 N·m

VF3000/5000 Series

How to Order Pilot Valve Assembly (With a gasket and two mounting screws)

⚠ Caution

When only the pilot valve assembly is replaced, it is not possible to change from V211 (Grommet or L/M-type) to V212 (DIN or Conduit type), or vice versa.

Valve model: VF□□□□□□ - 5 G Z □ 1 - □□□□

* Select from the below in accordance with the valve used.

■ Grommet or L/M-type

V 2 1 1 □□ - 5 G Z

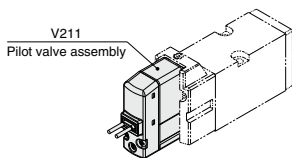

● Light/Surge voltage suppressor

		DC	AC
Nil	Without light/surge voltage suppressor	○	○
S	With surge voltage suppressor	○	— ^{Note)}
Z	With light/surge voltage suppressor	○	○
R	With surge voltage suppressor (Non-polar)	○	—
U	With light/surge voltage suppressor (Non-polar)	○	—

Note) S type is not available with AC mode, since a rectifier prevents surge voltage generation. When T is selected, only Z type of light/surge voltage suppressor is available.

⚠ Caution

When using the surge voltage suppressor type, residual voltage will remain. Refer to page 348 for details.

● Electrical entry

G	Grommet (Lead wire length 900 mm)	
H	Grommet (Lead wire length 600 mm)	
L	L-type plug connector	With lead wire
LN		Without lead wire
LO	Without connector	
M	M-type plug connector	With lead wire
MN		Without lead wire
MO		Without connector

* LN and MN types are with 2 sockets.

* Refer to page 346 when different length of lead wire for L/M-type plug connector is required.

■ DIN or Conduit type

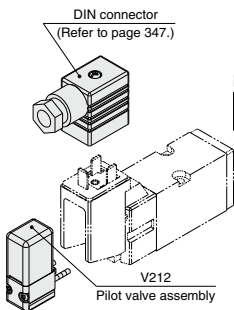

V 2 1 2 □□ - 5

● Pressure specifications

Nil	Standard (0.7 MPa)
K	High-pressure type (1 MPa)

● Coil specifications

Nil	Standard
T	With power saving circuit (DC only)

* T type is available with DC mode only.

● Rated voltage

DC	
5	24 VDC
6	12 VDC
AC (50/60 Hz)	
1	100 VAC
2	200 VAC
3	110 VAC [115 VAC]
4	220 VAC [230 VAC]
7	240 VAC
B	24 VAC

⚠ Caution

For V212 (DIN or Conduit type), the coil specifications (DIN and voltage (including light/surge voltage suppressor) cannot be changed by replacing the pilot valve assembly.

⚠ Caution

Tightening torque of the pilot valve assembly mounting screw

M2.5: 0.32 N·m

316

Dimensions: VF3000 Series/Base Mounted

2-position single

Grommet (G) (H): VF3140-□_G□_H□□1-02□₀₃□

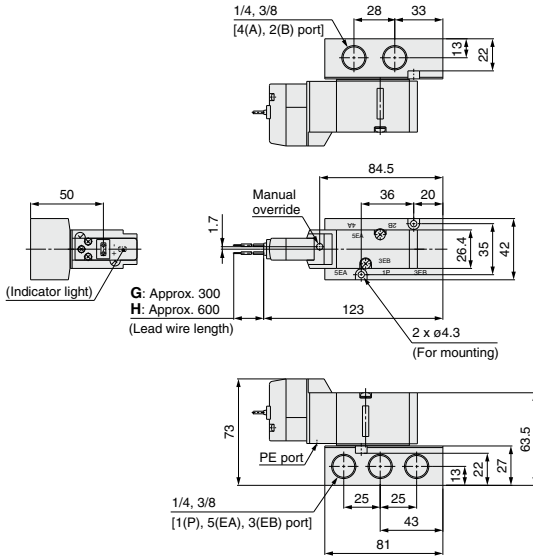

Grommet (G) (H)
DC without light/surge voltage suppressor

G: Approx. 300
H: Approx. 600
(Lead wire length)

SV
SYJ
SZ
VF
VP4
VQ 1/2
VQ 4/5
VQC 1/2
VQC 4/5
VQZ
SQ
VFS
VFR
VQ7

L-type plug connector (L): VF3140-□_L□□1-02□₀₃□

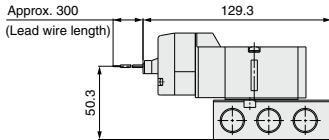

Unless otherwise indicated, dimensions are the same as Grommet (G).

DIN terminal (D) (Y): VF3140-□_D□□1-02□₀₃□

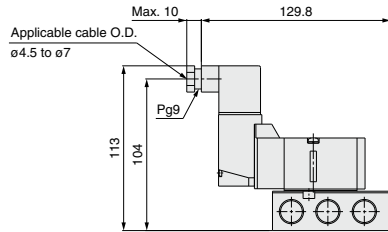

Unless otherwise indicated, dimensions are the same as Grommet (G).

M-type plug connector (M): VF3140-□_M□□1-02□₀₃□

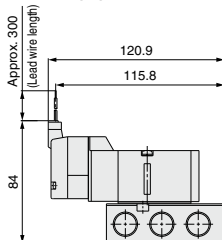

Unless otherwise indicated, dimensions are the same as Grommet (G).

Conduit terminal (T): VF3140-□_T□□1-02□₀₃□

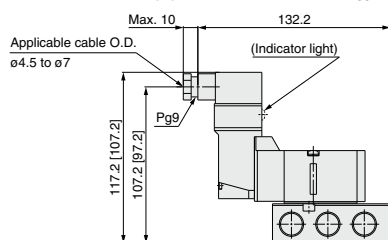

[]: Without indicator light
Unless otherwise indicated, dimensions are the same as Grommet (G).

VF3000/5000 Series

Dimensions: VF3000 Series/Base Mounted

2-position double

Grommet (G) (H): VF3240-□G□□1-02□□

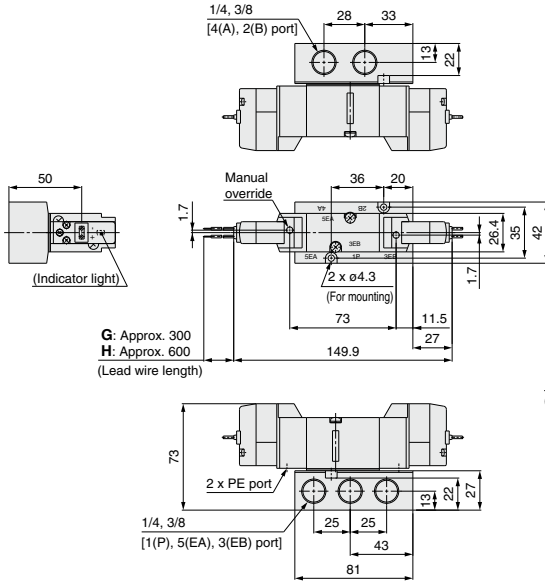

Grommet (G) (H)
 DC without light/surge voltage suppressor

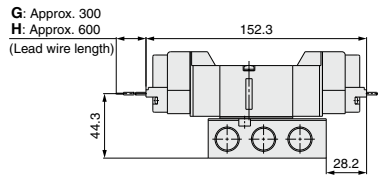

L-type plug connector (L): VF3240-□L□□1-02□□

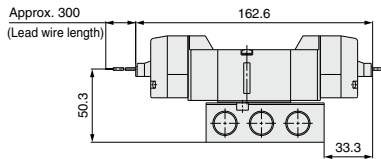

Unless otherwise indicated, dimensions are the same as Grommet (G).

DIN terminal (D) (Y): VF3240-□D□□1-02□□

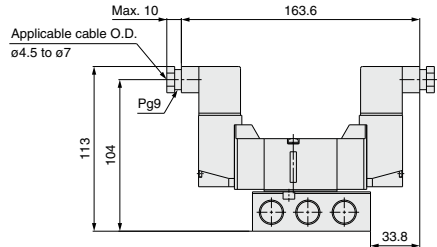

Unless otherwise indicated, dimensions are the same as Grommet (G).

M-type plug connector (M): VF3240-□M□□1-02□□

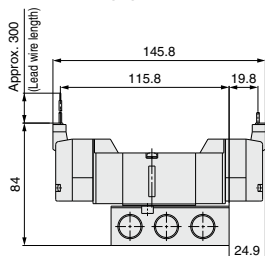

Unless otherwise indicated, dimensions are the same as Grommet (G).

Conduit terminal (T): VF3240-□T□□1-02□□

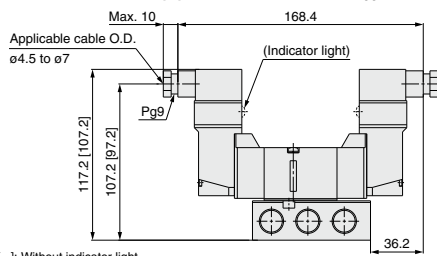

[]: Without indicator light
 Unless otherwise indicated, dimensions are the same as Grommet (G).

Dimensions: VF3000 Series/Base Mounted

3-position closed center/exhaust center/pressure center

Grommet (G) (H): VF3³₅40-□□G□□1-02₀₃□

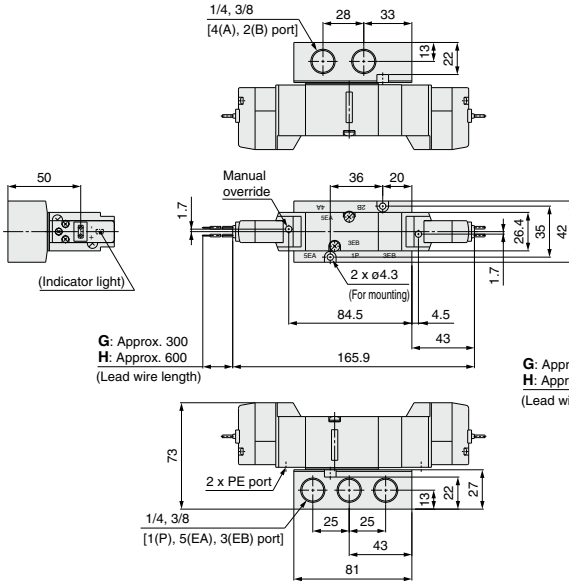

G: Approx. 300
H: Approx. 600
(Lead wire length)

Grommet (G) (H)
DC without light/surge voltage suppressor

G: Approx. 300
H: Approx. 600
(Lead wire length)

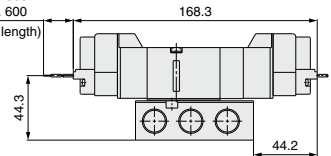

L-type plug connector (L): VF3³₅40-□□L□□1-02₀₃□

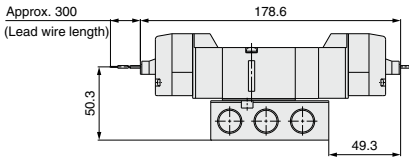

Unless otherwise indicated, dimensions are the same as Grommet (G).

DIN terminal (D) (Y): VF3³₅40-□□D□□1-02₀₃□

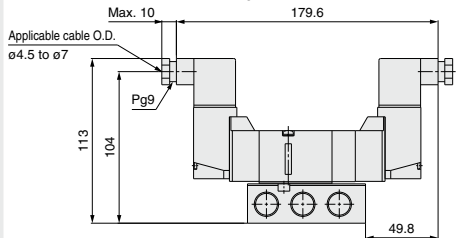

Unless otherwise indicated, dimensions are the same as Grommet (G).

M-type plug connector (M): VF3³₅40-□□M□□1-02₀₃□

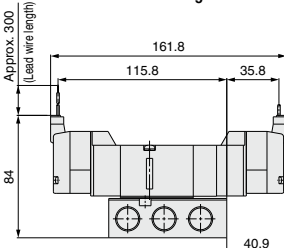

Unless otherwise indicated, dimensions are the same as Grommet (G).

Conduit terminal (T): VF3³₅40-□□T□□1-02₀₃□

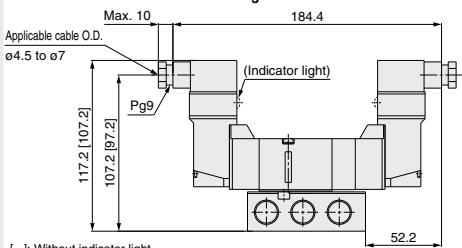

[]: Without indicator light
Unless otherwise indicated, dimensions are the same as Grommet (G).

SV
SYJ
SZ
VF
VP4
VQ 1/2
VQ 4/5
VQC 1/2
VQC 4/5
VQZ
SQ
VFS
VFR
VQ7

VF3000/5000 Series

Dimensions: VF5000 Series/Base Mounted

2-position single

Grommet (G) (H): VF5144-□G□□1-⁰²₀₃□₀₄

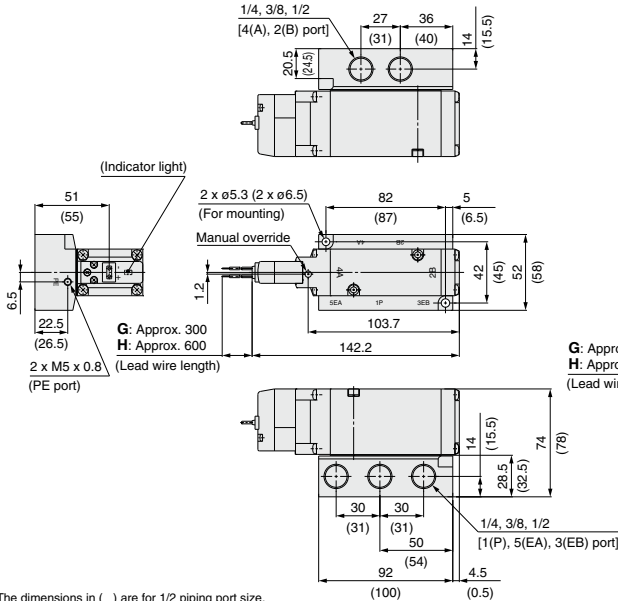

Grommet (G) (H) DC without light/surge voltage suppressor

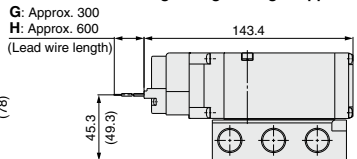

The dimensions in () are for 1/2 piping port size.

L-type plug connector (L): VF5144-□L□□1-⁰²₀₃□₀₄

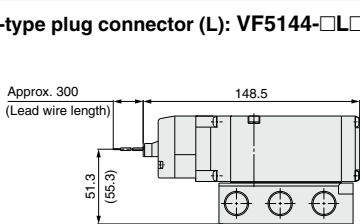

Unless otherwise indicated, dimensions are the same as Grommet (G).
The dimensions in () are for 1/2 piping port size.

DIN terminal (D) (Y): VF5144-□D□□1-⁰²₀₃□₀₄

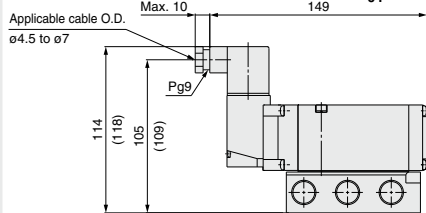

Unless otherwise indicated, dimensions are the same as Grommet (G).
The dimensions in () are for 1/2 piping port size.

M-type plug connector (M): VF5144-□M□□1-⁰²₀₃□₀₄

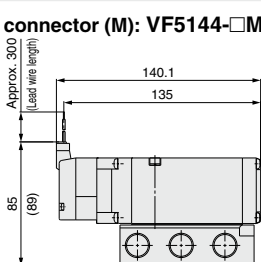

Unless otherwise indicated, dimensions are the same as Grommet (G).
The dimensions in () are for 1/2 piping port size.

Conduit terminal (T): VF5144-□T□□1-⁰²₀₃□₀₄

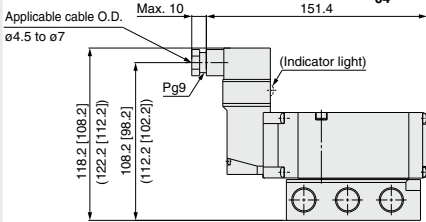

Unless otherwise indicated, dimensions are the same as Grommet (G).
[] : Without indicator light
The dimensions in () are for 1/2 piping port size.

Dimensions: VF5000 Series/Base Mounted

2-position double

Grommet (G) (H): VF5244-□G□□1-⁰²₀₃□₀₄

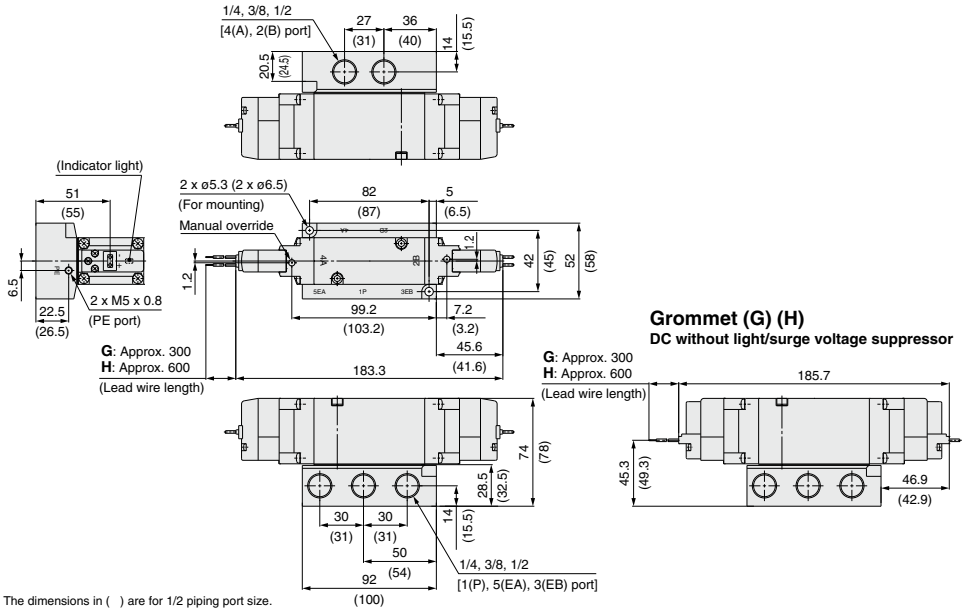

The dimensions in () are for 1/2 piping port size.

L-type plug connector (L): VF5244-□L□□1-⁰²₀₃□₀₄

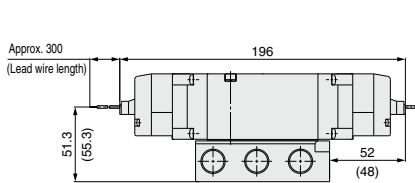

Unless otherwise indicated, dimensions are the same as Grommet (G).
The dimensions in () are for 1/2 piping port size.

M-type plug connector (M): VF5244-□M□□1-⁰²₀₃□₀₄

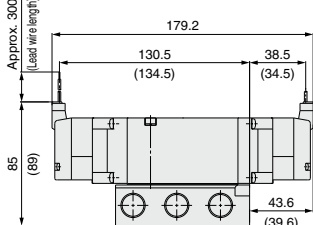

Unless otherwise indicated, dimensions are the same as Grommet (G).
The dimensions in () are for 1/2 piping port size.

DIN terminal (D) (Y): VF5244-□D□□1-⁰²₀₃□₀₄

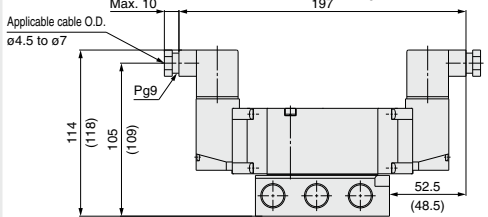

Unless otherwise indicated, dimensions are the same as Grommet (G).
The dimensions in () are for 1/2 piping port size.

Conduit terminal (T): VF5244-□T□□1-⁰²₀₃□₀₄

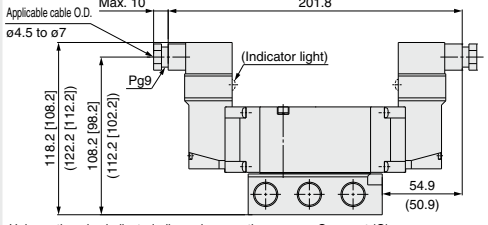

Unless otherwise indicated, dimensions are the same as Grommet (G).
[]: Without indicator light
The dimensions in () are for 1/2 piping port size.

SV
SYJ
SZ
VF
VP4
VQ 1/2
VQ 4/5
VQC 1/2
VQC 4/5
VQZ
SQ
VFS
VFR
VQ7

VF3000/5000 Series

Dimensions: VF5000 Series/Base Mounted

3-position closed center/exhaust center/pressure center

Grommet (G) (H): VF5³₅44-□□□□1-⁰²₀₃□□⁰⁴

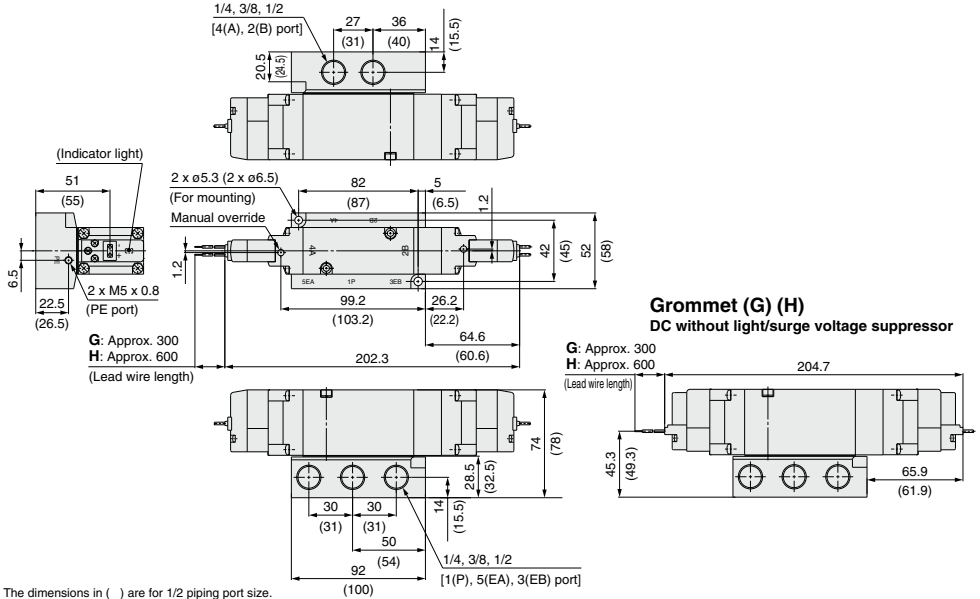

L-type plug connector (L): VF5³₅44-□□□□L-⁰²₀₃□□⁰⁴

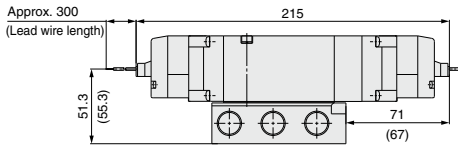

Unless otherwise indicated, dimensions are the same as Grommet (G).
The dimensions in () are for 1/2 piping port size.

DIN terminal (D) (Y): VF5³₅44-□□□□D-⁰²₀₃□□⁰⁴

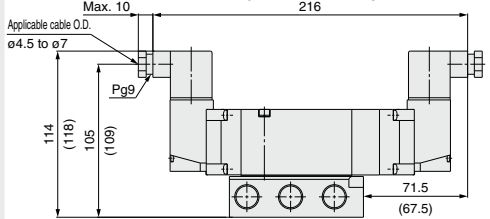

Unless otherwise indicated, dimensions are the same as Grommet (G).
The dimensions in () are for 1/2 piping port size.

M-type plug connector (M): VF5³₅44-□□□□M-⁰²₀₃□□⁰⁴

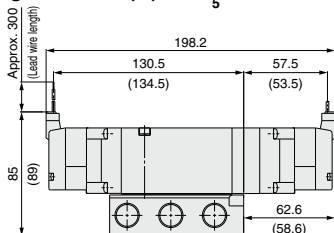

Unless otherwise indicated, dimensions are the same as Grommet (G).
The dimensions in () are for 1/2 piping port size.

Conduit terminal (T): VF5³₅44-□□□□T-⁰²₀₃□□⁰⁴

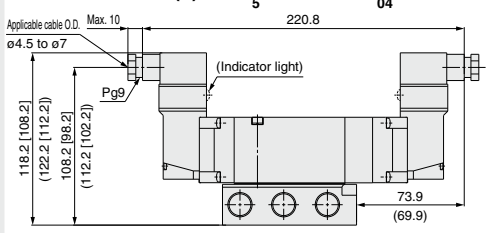

Unless otherwise indicated, dimensions are the same as Grommet (G).
[] : Without indicator light
The dimensions in () are for 1/2 piping port size.

Body Ported
Base Mounted

Low Wattage Specification VF1000/3000 Series C C

Single Unit

RoHS

How to Order Valve

VF 3 1 3 0 Y - 5 G [] [] 1 - 02 [] - []

Series

1	VF1000
3	VF3000

Type of actuation

1	2-position single
2	2-position double
3	3-position closed center
4	3-position exhaust center
5	3-position pressure center

* Only 1 and 2 are available with the VF1000.

Body model

		Mountable manifold		
		30	31	40
2	VF1000 Body ported	—	—	—
3	VF1000 Body ported (For manifold)	● (Note 1)	● (Note 1)	—
	VF3000 Body ported	● (Note 1)	—	—
4	VF3000 Base mounted	—	—	● (Note 2)

Note 1) Refer to page 327.

Note 2) Refer to page 338.

Body option

0: Pilot valve individual exhaust	
PE port	EA/EB port
VF1000	VF3000
○	○
3: Main/Pilot valve common exhaust	
PE port	EA/EB port
VF1000	VF3000
●*	○

* Only available for body ported (for manifold) type.

Low wattage type

Rated voltage

1	100 VAC
2	200 VAC
3	110 VAC
4	220 VAC
5	24 VDC
6	12 VDC

Bracket

Nil	Without bracket
F	With bracket

Available with the VF1120, VF1220 and VF3130 only.

Thread type

Nil	Rc, M5
F	G
N	NPT
T	NPTF

<Body ported> A, B port size

M5	M5 x 0.8 (VF1000)
01	1/8 (VF1000, VF3000)
02	1/4 (VF3000)

<Base mounted> Sub-plate port size

Nil	Without sub-plate
02	Port size: 1/4
03	Port size: 3/8

Version symbol

Manual override

Nil	Non-locking push type
D	Push-turn locking slotted type
E	Push-turn locking lever type

Light/Surge voltage suppressor and common specifications

Nil	Without light/surge voltage suppressor	—
R	With surge voltage suppressor (DC only, Non-polar)	D and Y are not available
U	With light/surge voltage suppressor (DC only, Non-polar)	D and Y are not available
S	With surge voltage suppressor (DC only)	—
Z	With light/surge voltage suppressor	DOZ and YOZ are not available

Electrical entry

24 VDC, 12 VDC/100 VAC, 110 VAC, 200 VAC, 220 VAC				24 VDC, 12 VDC/100 VAC, 110 VAC, 200 VAC, 220 VAC	
Grommet		L-type plug connector	M-type plug connector	DIN terminal	
G: Lead wire length 300 mm	L: With lead wire (length 300 mm)	M: With lead wire (length 300 mm)	MN: Without lead wire	D: With connector	YO: With connector
H: Lead wire length 600 mm	LN: Without lead wire	LO: Without connector	MO: Without connector	DO: Without connector	YO: Without connector
CE compliant	DC	●	●	●	●
	AC	—	—	●	●

* LN and MN types are with 2 sockets.

* Y type DIN terminal complies with EN-175301-803C (former DIN 43650C). Refer to page 347 for details.

* When using IP65, select the main/pilot valve common exhaust type. (Except VF1000)

SV

SYJ

SZ

VF

VP4

VQ 1/2

VQ 4/5

VQC 1/2

VQC 4/5

VQZ

SQ

VFS

VFR

VQ7

VF1000/3000 Series

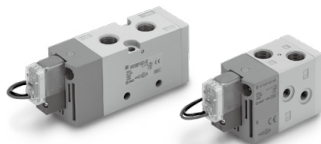

Specifications

Model		VF1000	VF3000
Fluid		Air	
Internal pilot operating pressure range (MPa)	2-position single/3-position	0.15 to 0.7	
	2-position double	0.1 to 0.7	
Ambient and fluid temperature (°C)		-10 to 50 (No freezing)	
Max. operating frequency (Hz)	2-position single/double	5	5
	3-position	3	3
Manual override		Non-locking push type Push-turn locking slotted type Push-turn locking lever type	
Pilot exhaust type		Main/Pilot valve common exhaust	
Lubrication		Not required	
Mounting orientation		Unrestricted	
Impact/Vibration resistance (m/s²) <small>Note)</small>		150/30	
Enclosure		Dustproof (IP65* for DIN terminal)	

* Based on IEC 60529.

Note) Impact resistance: No malfunction occurred when it is tested in the axial direction and at the right angles to the main valve and armature in both energized and de-energized states every once for each condition. (Values at the initial period)

Vibration resistance: No malfunction occurred in a one-sweep test between 45 and 2000 Hz. Test was performed at both energized and de-energized states in the axial direction and at the right angles to the main valve and armature. (Values at the initial period)

Solenoid Specifications

Electrical entry		Grommet (G), (H) L-type plug connector (L) M-type plug connector (M)	DIN terminal (D), (Y)	
		G, H, L, M	D, Y	
Coil rated voltage (V)	DC	24, 12		
	AC (50/60 Hz)	100, 110, 200, 220		
Allowable voltage fluctuation		±10% of rated voltage*		
Power consumption (W)	DC	Standard		
	Standard	0.35 (With light: 0.4 (With light of DIN terminal: 0.45))		
Apparent power (VA) [⊛]	AC	100 V	0.78 (With light: 0.81)	0.78 (With light: 0.87)
		110 V [115 V]	0.86 (With light: 0.89) [0.94 (With light: 0.97)]	0.86 (With light: 0.97) [0.94 (With light: 1.07)]
		200 V	1.18 (With light: 1.22)	1.15 (With light: 1.30)
		220 V [230 V]	1.30 (With light: 1.34) [1.42 (With light: 1.46)]	1.27 (With light: 1.46) [1.39 (With light: 1.60)]
		Surge voltage suppressor	Diode (DIN terminal, Non-polar type: Varistor)	
Indicator light		LED (Neon light is used for AC mode of DIN terminal.)		

* It is in common between 110 VAC and 115 VAC, and between 220 VAC and 230 VAC.

⊛ Allowable voltage fluctuation is -15% to +5% of the rated voltage for 115 VAC or 230 VAC.

⊛ Since voltage drops due to the internal circuit in S and Z types, the allowable voltage fluctuation should be within the following range:
24 VDC: -7% to +10%
12 VDC: -4% to +10%

Response Time

Series	Type of actuation	Response time (ms) (at 0.5 MPa)			AC
		Without light/surge voltage suppressor	With light/surge voltage suppressor		
		S, Z type	R, U type		
VF1000	2-position single	45	55	45	45
	2-position double	12	12	12	12
VF3000	2-position single	55	63	55	50
	2-position double	14	14	14	16
	3-position	100	100	90	90

Low Wattage Specification **VF1000/3000 Series** Body Ported/Base Mounted/Single Unit

Dimensions

VF1000

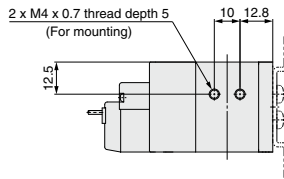
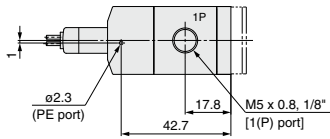
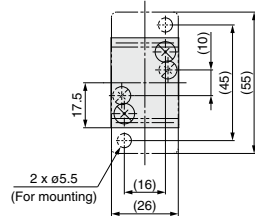
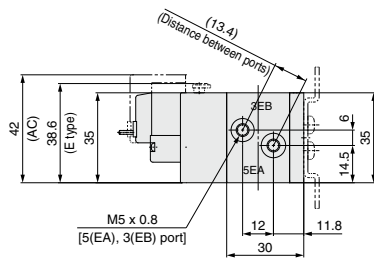
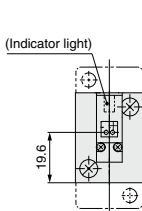
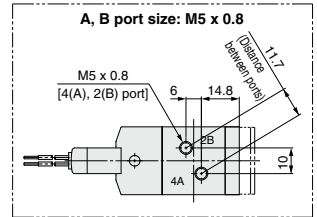
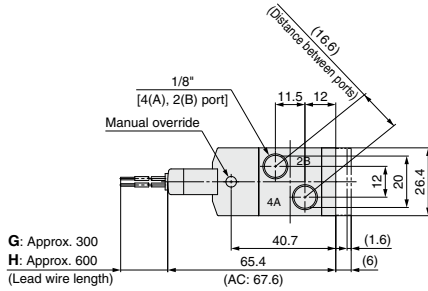

L-type plug connector (L)

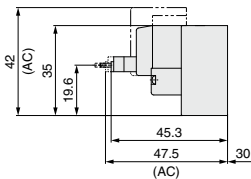

M-type plug connector (M)

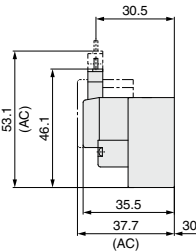

DIN terminal (D)

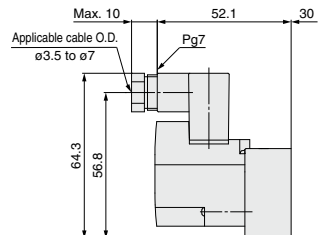

- SV
- SVJ
- SZ
- VF
- VP4
- VQ 1/2
- VQ 4/5
- VQC 1/2
- VQC 4/5
- VQZ
- SQ
- VFS
- VFR
- VQ7

VF1000/3000 Series

Dimensions

VF3000

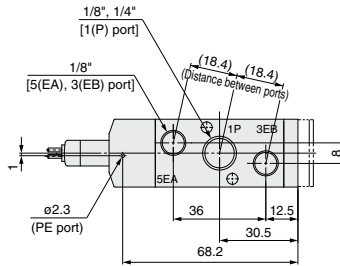
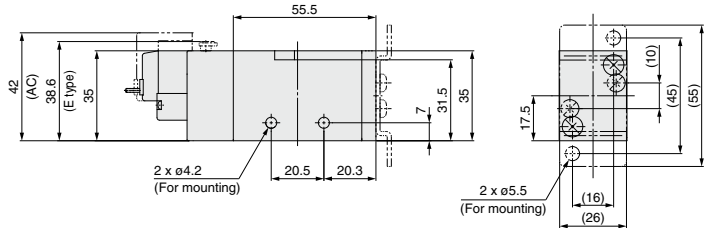
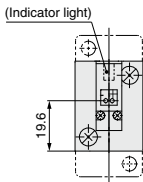
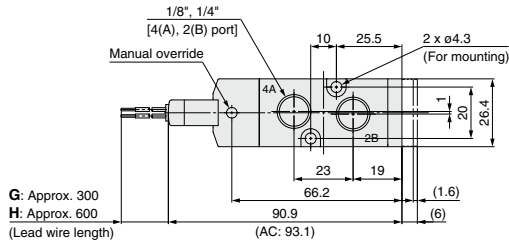

L-type plug connector (L)

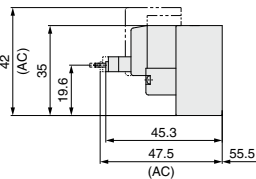

M-type plug connector (M)

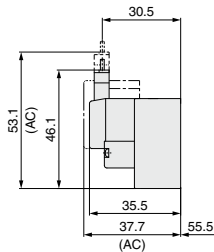

DIN terminal (D) (Y)

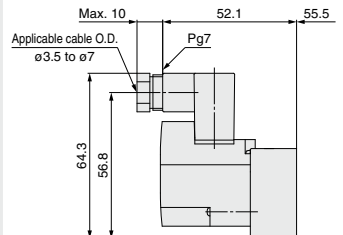

Pilot Operated 5 Port Solenoid Valve VF1000/3000/5000 Series Manifold

Body Ported



Note) Only DIN and conduit terminal types are available with AC mode.
Refer to the electrical entry for details.

How to Order Manifold

Common exhaust

VV5F 1 - 30 - 04 1 -

Series

1	VF1000
3	VF3000
5	VF5000

Manifold model

Symbol	P, R port size	VF1000	VF3000	VF5000
30	1/8	○	—	—
	1/4	—	○	—
20	3/8	—	—	○
21	1/2	—	—	○

Stations

02	2 stations
...	...
20	20 stations

* Up to 10 stations for VV5F5-20, and up to 15 stations for VV5F5-21.

Thread type

Nil	Rc
00F	G
00N	NPT
00T	NPTF

Individual exhaust (VF1000 only)

VV5F1 - 31 - 04 3 -

Series

1	VF1000
3	VF3000
5	VF5000

Manifold model

Symbol	P, R port size	EA, EB port size
31	1/8	M5

Stations

02	2 stations
...	...
20	20 stations

Thread type

Nil	Rc
00F	G
00N	NPT
00T	NPTF

Manifold model

Symbol	P, R port size	EA, EB port size
31	1/8	M5

* The A and B ports are made on the top.

Note) When placing an order for body ported valve as a single unit, mounting screws for manifold and gasket are not attached. Order them separately, if necessary. (Refer to page 329 for details.)

How to Order Valve

* For low wattage specification, refer to "How to Order Valve" on page 323.

VF 3 1 3 0 - 5 G - 1 - 01 -

Series

1	VF1000
3	VF3000
5	VF5000

Type of actuation

1	2-position single
2	2-position double
3	3-position closed center
4	3-position exhaust center
5	3-position pressure center

* Only 1 and 2 are available with the VF1000.

Coil specifications

Nil	Standard
T	With power saving circuit (DC only)

Note) Be sure to select the power saving circuit type when it is continuously energized for long periods of time. (Refer to page 348 for details.)

* T type is available with DC mode only. When T is selected, only Z type of light/surge voltage suppressor is available. (Note that when the electrical entry of DIN terminal type without connector is selected, only DOS and YOS are available.)

Pressure specifications

Nil	Standard (0.7 MPa)
K	High-pressure type (1 MPa)

Rated voltage

DC	AC (50/60 Hz)			
5 24 VDC	1 100 VAC	4 220 VAC (230 VAC)		
6 12 VDC	2 200 VAC	7 240 VAC		
	3 110 VAC (115 VAC)	B 24 VAC		

Body model

Symbol	VF1000	VF3000	VF5000
2	—	—	—
3	○	○	○

Note) Manifold only.

Body option

0: Pilot valve individual exhaust 3: Main/Pilot valve common exhaust

	PE port	EA/EB port	PE port	EA/EB port
VF1000	○	○	○	○
VF3000	○	○	○	○
VF5000	○	○	○	○

Made to order

Refer to page 311 for details.
Combination with low wattage specification is not possible.

Thread type

Nil	Rc
F	G
N	NPT
T	NPTF

* M5 is available with Nil only.

Manual override

Nil: Non-locking push type

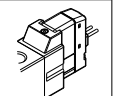

D: Push-turn locking slotted type

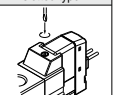

E: Push-turn locking lever type

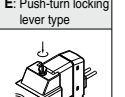

Light/Surge voltage suppressor

Symbol	Light/Surge voltage suppressor	DC	AC
Nil	Without light/surge voltage suppressor	○	○
S	With surge voltage suppressor	○	⊗(R)
Z	With light/surge voltage suppressor	○	○
R	With surge voltage suppressor (Non-polar)	○	○
U	With light/surge voltage suppressor (Non-polar)	○	○

Note) S type is not available with AC mode, since a rectifier prevents surge voltage generation.

* In the DIN terminal type, since a light is installed in the connector, DOZ, DOU, YOZ, YOU are not available.

Electrical entry

Grommet		L-type plug connector		M-type plug connector		DIN terminal (IP65 compatible)	DIN (EN175301-803) terminal (IP65 compatible)	Conduit terminal (IP65 compatible)
G: Lead wire length 300 mm	H: Lead wire length 600 mm	L: With lead wire (length 300 mm)	LN: Without lead wire	M: With lead wire (length 300 mm)	MN: Without lead wire	D: With connector	Y: With connector	T: Conduit terminal
		LO: Without connector		MO: Without connector		DO: Without connector	YO: Without connector	
CE	DC	CE	CE	CE	CE	CE	CE	CE
compliant	AC ^(IEC 60335-2)							

* LN and MN types are with 2 sockets. * Refer to page 346 when different length of lead wire for LM-type plug connector is required.
* Refer to page 347 for details on the DIN (EN175301-803) terminal.
Note 1) When using IP65, select the main/pilot valve common exhaust type.
Note 2) With the same specifications as the DC type, all electrical entries for the 24 VAC type are CE marking compliant.

Caution

When using the surge voltage suppressor type, residual voltage will remain. Refer to page 348 for details.

VF1000/3000/5000 Series

Manifold Specifications

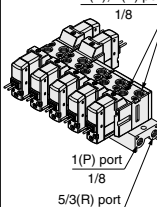
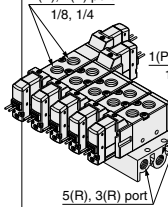
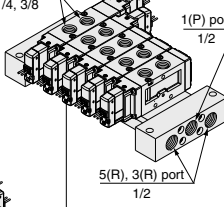
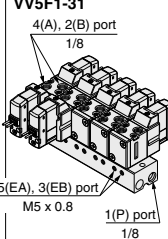
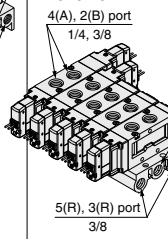
Series	VF1000		VF3000	VF5000	
Manifold base model	VV5F1-30 		VV5F3-30 	VV5F5-21 	
	VV5F1-31 		VV5F5-20 		
EXH port type	Common EXH	Individual EXH	Common EXH	Common EXH	Common EXH
Applicable valve model	VF1□30 VF1□33		VF3□30 VF3□33	VF5□20 VF5□23	
Applicable stations	2 to 20 stations		2 to 20 stations	2 to 10 stations	2 to 15 stations
Manifold base Weight: W [g] Stations: n	W = 29n + 21	W = 51n + 35	W = 63n + 64	W = 97n + 80	W = 139n + 550

Note) Supply pressure to 1(P) ports and exhaust pressure from R ports on both sides for 10 stations or more (5 stations or more for the VF5000).

How to Order Manifold Assembly

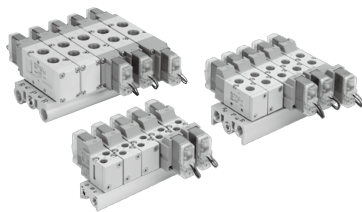

Example (VV5F3-30)

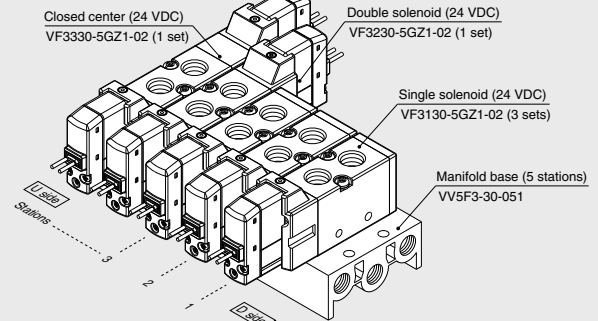

VV5F3-30-051 1 set (Type 30, 5-station manifold base part no.)
 * **VF3130-5GZ1-02** 3 sets (Single solenoid part no.)
 * **VF3230-5GZ1-02** 1 set (Double solenoid part no.)
 * **VF3330-5GZ1-02** 1 set (Closed center part no.)
 ↳ The asterisk denotes the symbol for assembly. Prefix it to the part nos. of the solenoid valve, etc.

- The valve arrangement is numbered as the 1st station from D side.
- Under the manifold base part number, state the valves to be mounted in order from the 1st station as shown in the figure above. If the arrangement becomes complicated, specify on the manifold specification sheet.

Manifold Options

■ For body ported Blanking plate assembly

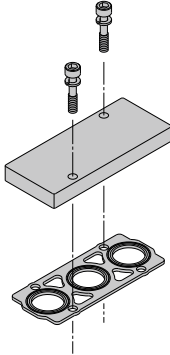

Series	Blanking plate assembly part no.
VF1000	DXT144-13-3A
VF3000	DXT031-38-5A
VF5000	VF5000-70-1A

■ Individual EXH spacer assembly

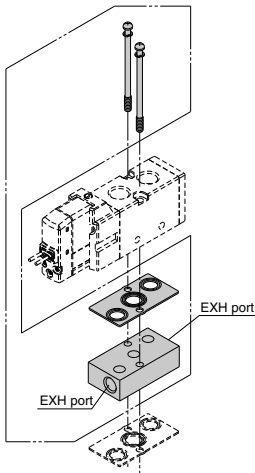

■ Mounting screw, gasket part no.

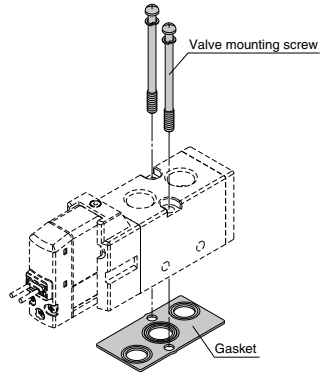

Series	Valve mounting screw (1 pc.)	Gasket
VF1000	Round head combination screw DXT031-44-1 (M4 x 39.5, With spring washer)	DXT144-12-2
VF3000		DXT155-25-7
VF5000	Hexagon socket head cap screw AXT620-32-1 (M4 x 48, With spring washer)	DXT156-9-6

SV
SYJ
SZ
VF
VP4
VQ 1/2
VQ 4/5
VQC 1/2
VQC 4/5
VQZ
SQ
VFS
VFR
VQ7

⚠ Caution

Tightening Torque for Mounting Screw

M4: 1.4 N·m

⚠ Warning

When mounting a valve or spacer on the manifold base or sub-plate, etc., the mounting orientation is already decided. If mounted in a wrong direction, the equipment to be connected may result in a malfunction. Refer to the dimensions for mounting.

VF **3** 000-75-1 **A**

Series

Symbol	Series	Port size
3	VF3000	1/8
5	VF5000	1/4

Thread type

Nll	Rc
F	G
N	NPT
T	NPTF

VF1000/3000/5000 Series

Dimensions: VF1000 Series

Type 30/VV5F1-30-□□1-□: Common exhaust
Grommet (G) (H)

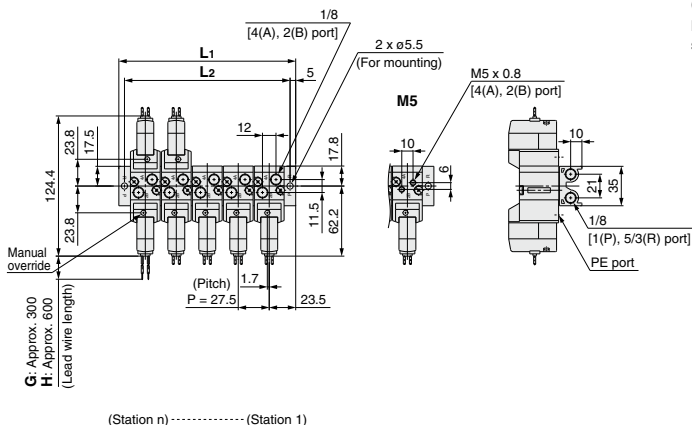

Grommet (G) (H)
DC without light/
surge voltage suppressor

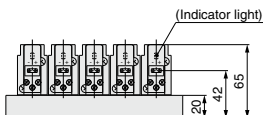
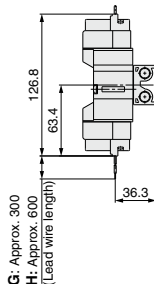

L-type plug connector (L)

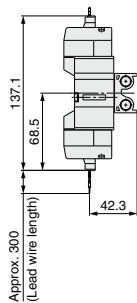

L: Dimensions

n: Stations

n	2	3	4	5	6	7	8	9	10	11	12	13	14
L1	74.5	102	129.5	157	184.5	212	239.5	267	294.5	322	349.5	377	404.5
L2	64.5	92	119.5	147	174.5	202	229.5	257	284.5	312	339.5	367	394.5

n	15	16	17	18	19	20
L1	432	459.5	487	514.5	542	569.5
L2	422	449.5	477	504.5	532	559.5

Unless otherwise indicated, dimensions are the same as Grommet (G).

M-type plug connector (M)

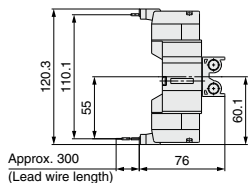

DIN terminal (D) (Y)

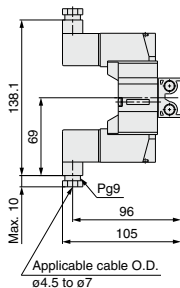

Conduit terminal (T)

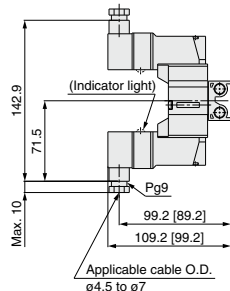

Unless otherwise indicated, dimensions are the same as Grommet (G).

Unless otherwise indicated, dimensions are the same as Grommet (G).

[]: Without indicator light
Unless otherwise indicated, dimensions are the same as Grommet (G).

Dimensions: VF1000 Series

Type 31/VV5F1-31-□□3-□: Individual exhaust Grommet (G) (H)

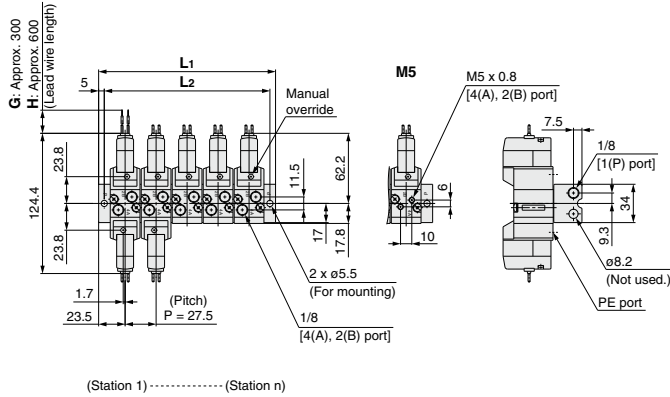

Grommet (G) (H) DC without light/surge voltage suppressor

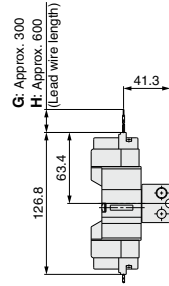

(Station 1) (Station n)

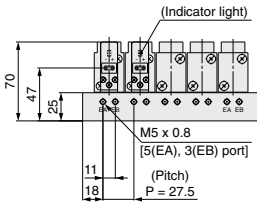

L-type plug connector (L)

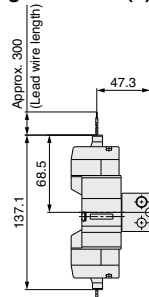

L: Dimensions

n: Stations

n	2	3	4	5	6	7	8	9	10	11	12	13	14
L1	74.5	102	129.5	157	184.5	212	239.5	267	294.5	322	349.5	377	404.5
L2	64.5	92	119.5	147	174.5	202	229.5	257	284.5	312	339.5	367	394.5

n	15	16	17	18	19	20
L1	432	459.5	487	514.5	542	569.5
L2	422	449.5	477	504.5	532	559.5

Unless otherwise indicated, dimensions are the same as Grommet (G).

M-type plug connector (M)

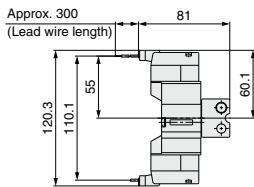

DIN terminal (D) (Y)

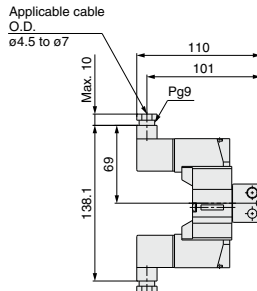

Conduit terminal (T)

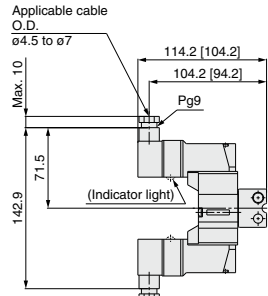

Unless otherwise indicated, dimensions are the same as Grommet (G).

Unless otherwise indicated, dimensions are the same as Grommet (G).

[]: Without indicator light. Unless otherwise indicated, dimensions are the same as Grommet (G).

SV
SYJ
SZ
VF
VP4
VQ 1/2
VQ 4/5
VQC 1/2
VQC 4/5
VQZ
SQ
VFS
VFR
VQ7

VF1000/3000/5000 Series

Dimensions: VF3000 Series

Type 30/VV5F3-30-□□1-□: Common exhaust
Grommet (G) (H)

Grommet (G) (H)
DC without light/
surge voltage suppressor

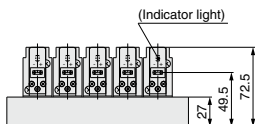
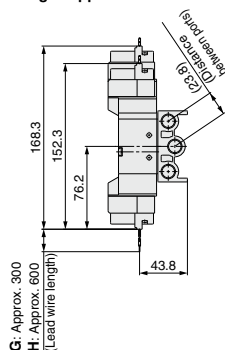
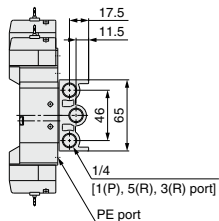
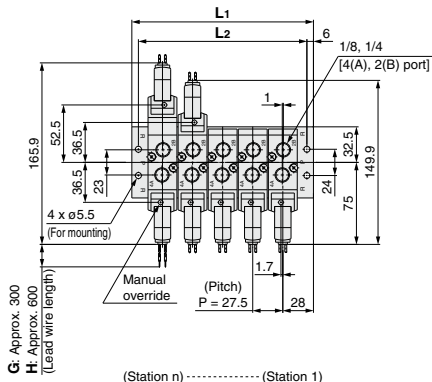

L-type plug connector (L)

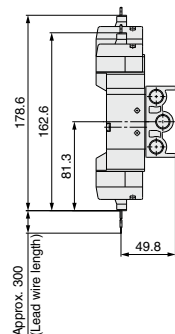

Unless otherwise indicated, dimensions are the same as Grommet (G).

L: Dimensions

L	n	2	3	4	5	6	7	8	9	10	11	12	13	14
L1		83.5	111	138.5	166	193.5	221	248.5	276	303.5	331	358.5	386	413.5
L2		71.5	99	126.5	154	181.5	209	236.5	264	291.5	319	346.5	374	401.5

L	n	15	16	17	18	19	20
L1		441	468.5	496	523.5	551	578.5
L2		429	456.5	484	511.5	539	566.5

M-type plug connector (M)

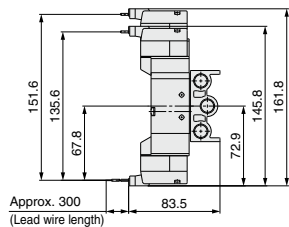

Unless otherwise indicated, dimensions are the same as Grommet (G).

DIN terminal (D) (Y)

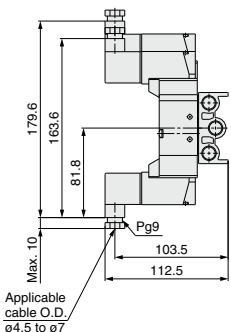

Unless otherwise indicated, dimensions are the same as Grommet (G).

Conduit terminal (T)

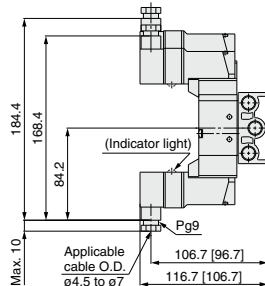

[]: Without indicator light
Unless otherwise indicated, dimensions are the same as Grommet (G).

Dimensions: VF3000 Series

Type 30/VV5F3-30-□□1-□: When the individual EXH spacer (VF3000-75-1A) is mounted.
Grommet (G) (H)

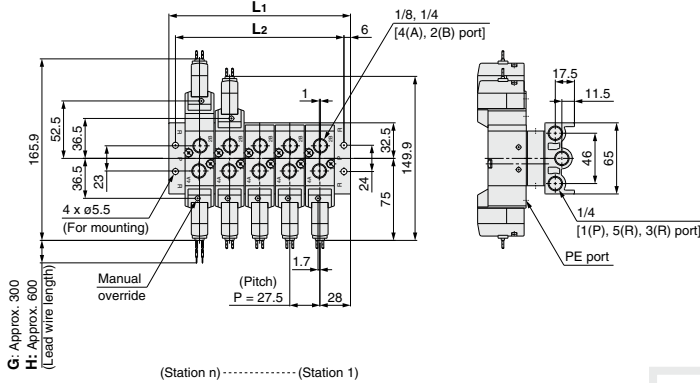

Grommet (G) (H)
DC without light/
surge voltage suppressor

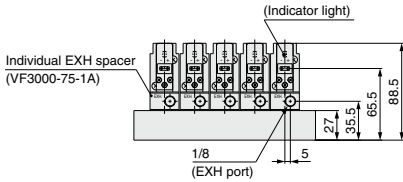
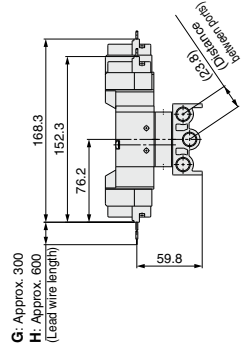

L: Dimensions

L	n	2	3	4	5	6	7	8	9	10	11	12	13	14
L1		83.5	111	138.5	166	193.5	221	248.5	276	303.5	331	358.5	386	413.5
L2		71.5	99	126.5	154	181.5	209	236.5	264	291.5	319	346.5	374	401.5

n: Stations

L	n	15	16	17	18	19	20
L1		441	468.5	496	523.5	551	578.5
L2		429	456.5	484	511.5	539	566.5

L-type plug connector (L)

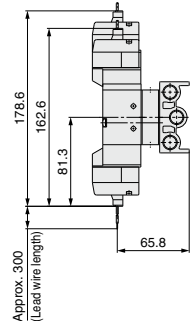

Unless otherwise indicated, dimensions are the same as Grommet (G).

M-type plug connector (M)

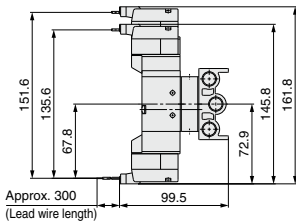

Unless otherwise indicated, dimensions are the same as Grommet (G).

DIN terminal (D) (Y)

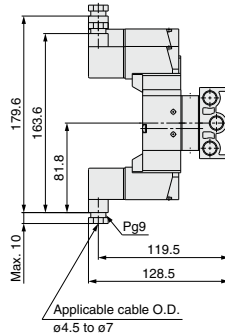

Unless otherwise indicated, dimensions are the same as Grommet (G).

Conduit terminal (T)

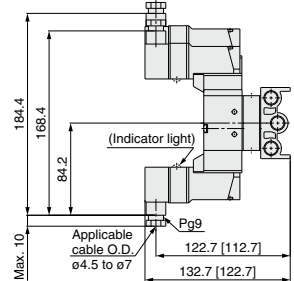

[]: Without indicator light
Unless otherwise indicated, dimensions are the same as Grommet (G).

SV
SYJ
SZ
VF
VP4
VQ 1/2
VQ 4/5
VQC 1/2
VQC 4/5
VQZ
SQ
VFS
VFR
VQ7

VF1000/3000/5000 Series

Dimensions: VF5000 Series

Type 20/VV5F5-20-□□1-□: Common exhaust Grommet (G)

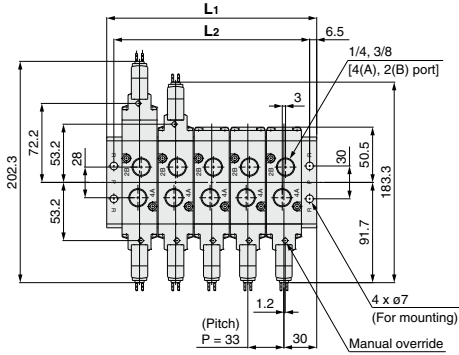

(Station n) (Station 1)

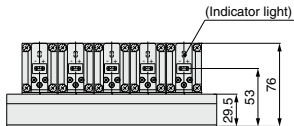

Grommet (G) (H)
DC without light/
surge voltage suppressor

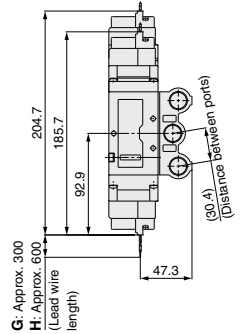
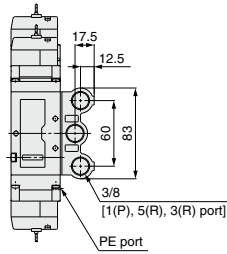

G: Approx. 300
H: Approx. 600
(Lead wire length)

L-type plug connector (L)

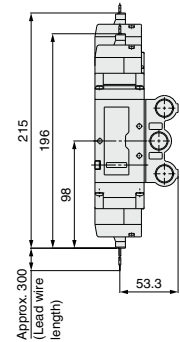

Unless otherwise indicated, dimensions are the same as Grommet (G).

L: Dimensions

n	2	3	4	5	6	7	8	9	10
L1	93	126	159	192	225	258	291	324	357
L2	80	113	146	179	212	245	278	311	344

M-type plug connector (M)

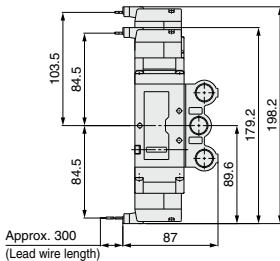

Unless otherwise indicated, dimensions are the same as Grommet (G).

DIN terminal (D) (Y)

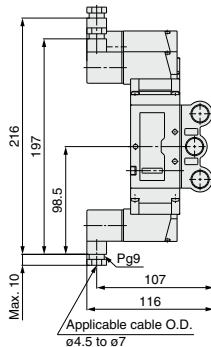

Unless otherwise indicated, dimensions are the same as Grommet (G).

Conduit terminal (T)

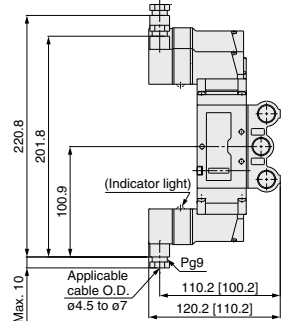

[]: Without indicator light
Unless otherwise indicated, dimensions are the same as Grommet (G).

Dimensions: VF5000 Series

Type 20/VV5F5-20-□□1-□: When the individual EXH spacer (VF5000-75-1A) is mounted.
Grommet (G)

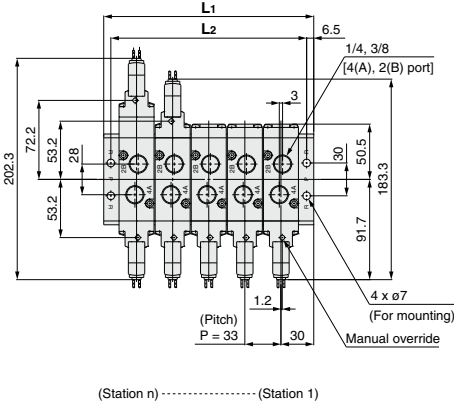

Grommet (G) (H)
DC without light/
surge voltage suppressor

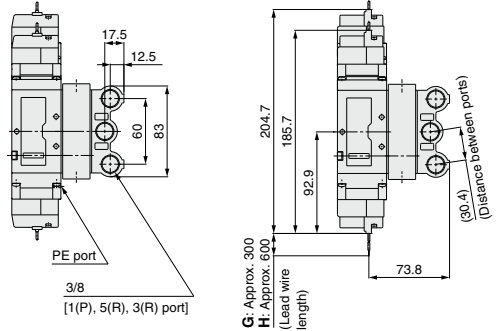

(Station n) (Station 1)

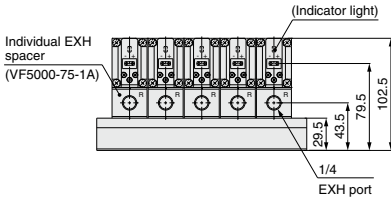

L: Dimensions

n	2	3	4	5	6	7	8	9	10
L1	93	126	159	192	225	258	291	324	357
L2	80	113	146	179	212	245	278	311	344

n: Stations

L-type plug connector (L)

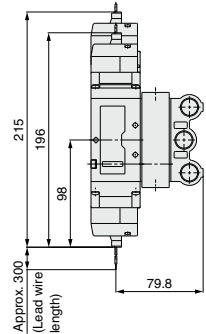

Unless otherwise indicated, dimensions are the same as Grommet (G).

M-type plug connector (M)

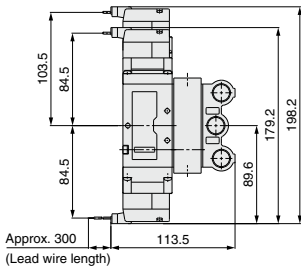

Unless otherwise indicated, dimensions are the same as Grommet (G).

DIN terminal (D) (Y)

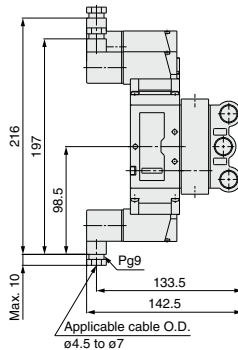

Unless otherwise indicated, dimensions are the same as Grommet (G).

Conduit terminal (T)

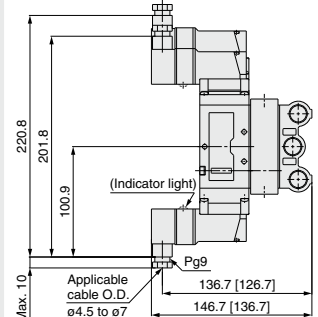

[]: Without indicator light
Unless otherwise indicated, dimensions are the same as Grommet (G).

VF1000/3000/5000 Series

Dimensions: VF5000 Series

Type 21/VV5F5-21-□□1-□: Common exhaust
Grommet (G)

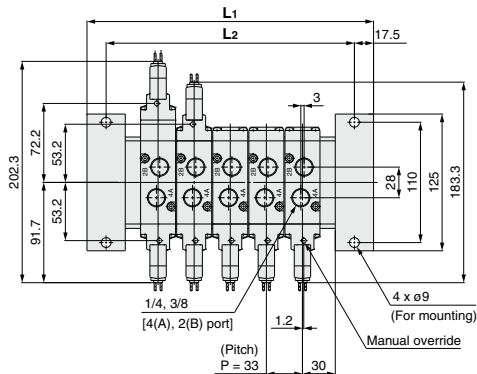

(Station n) (Station 1)

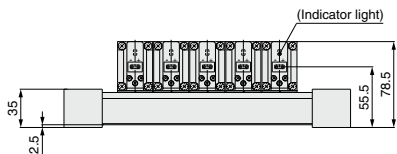

L: Dimensions

n	2	3	4	5	6	7	8	9	10	11	12	13	14	15
L1	163	196	229	262	295	328	361	394	427	460	493	526	559	592
L2	128	161	194	227	260	293	326	359	392	425	458	491	524	557

n: Stations

Grommet (G) (H) DC without light/ surge voltage suppressor

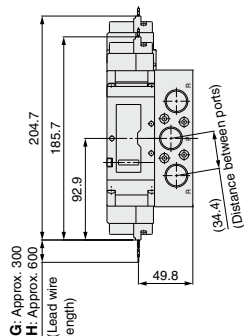
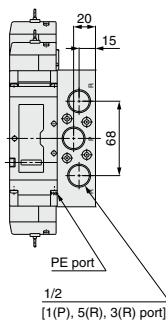

L-type plug connector (L)

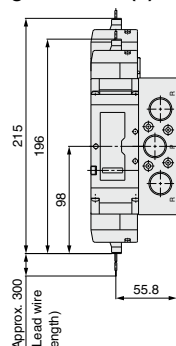

Unless otherwise indicated, dimensions are the same as Grommet (G).

M-type plug connector (M)

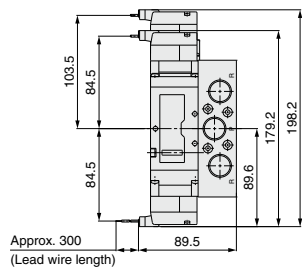

Unless otherwise indicated, dimensions are the same as Grommet (G).

DIN terminal (D) (Y)

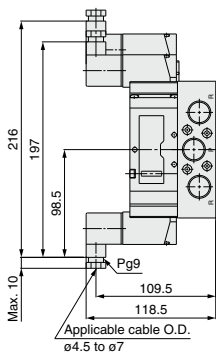

Unless otherwise indicated, dimensions are the same as Grommet (G).

Conduit terminal (T)

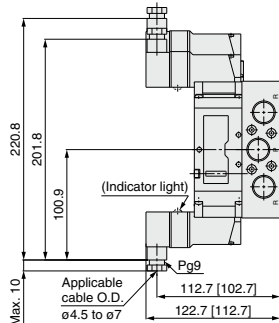

[]: Without indicator light
Unless otherwise indicated, dimensions are the same as Grommet (G).

Dimensions: VF5000 Series

Type 21/VV5F5-21-□□1-□: When the individual EXH spacer (VF5000-75-1A) is mounted.
Grommet (G)

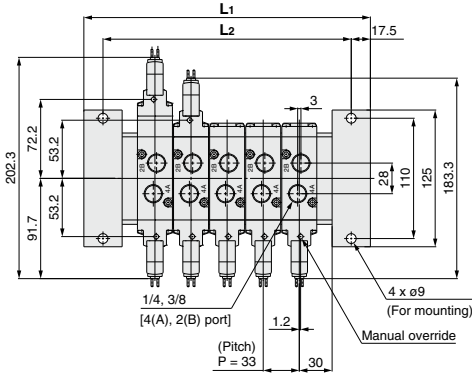

(Station n) (Station 1)

Grommet (G) (H)
DC without light/
surge voltage suppressor

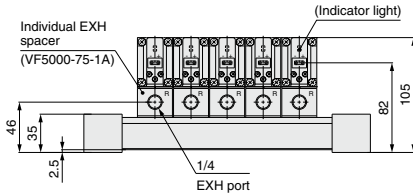
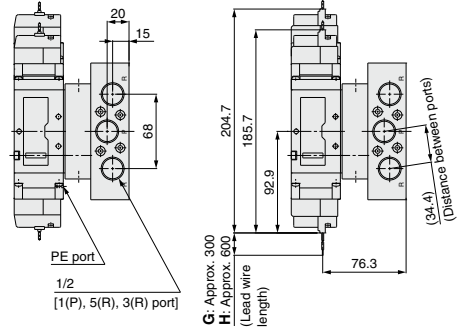

L-type plug connector (L)

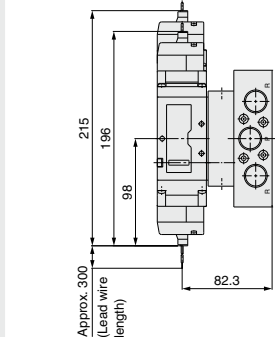

L: Dimensions

n	2	3	4	5	6	7	8	9	10	11	12	13	14	15
L1	163	196	229	262	295	328	361	394	427	460	493	526	559	592
L2	128	161	194	227	260	293	326	359	392	425	458	491	524	557

n: Stations

Unless otherwise indicated, dimensions are the same as Grommet (G).

M-type plug connector (M)

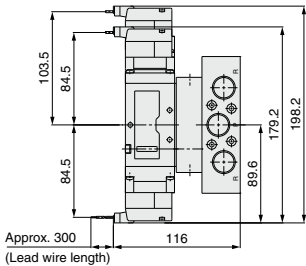

Unless otherwise indicated, dimensions are the same as Grommet (G).

DIN terminal (D) (Y)

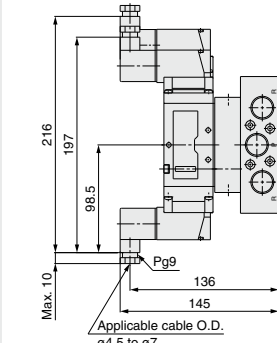

Unless otherwise indicated, dimensions are the same as Grommet (G).

Conduit terminal (T)

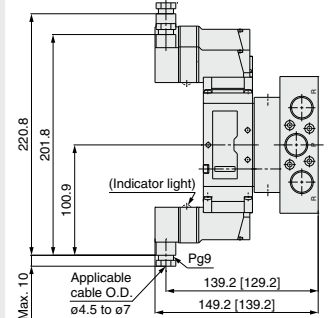

[]: Without indicator light
Unless otherwise indicated, dimensions are the same as Grommet (G).

SV
SYJ
SZ
VF
VP4
VQ 1/2
VQ 4/5
VQC 1/2
VQC 4/5
VQZ
SQ
VFS
VFR
VQ7

Pilot Operated 5 Port Solenoid Valve

VF3000/5000 Series

Manifold

Base Mounted



Note) Only DIN and conduit terminal types are available with AC mode.
Refer to the electrical entry for details.

How to Order Manifold

Common exhaust

VV5F 3 - 40 - 05 2 - 02 F

Symbol	Series	P, R port size	A, B port size
3	VF3000	1/4	1/4
5	VF5000	3/8	1/4

* The A and B ports are made on the bottom.

Symbol	Stations
02	2 stations
:	:
20	20 stations

* Up to 10 stations for VV5F5.

Thread type	
Nil	Rc
F	G
N	NPT
T	NPTF

How to Order Valve (With a gasket and two mounting screws)

* For low wattage specification, refer to "How to Order Valve" on page 323.

VF 3 1 4 0 - 5 G 1 -

Series	Symbol
3	VF3000
5	VF5000

* Not available with the VF1000.

Type of actuation	Symbol
2-position single	1
2-position double	2
3-position closed center	3
3-position exhaust center	4
3-position pressure center	5

Body model

Body option

0: Pilot valve individual exhaust



PE port E/AEB port

VF3000 VF5000

3: Main/Pilot valve common exhaust

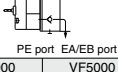

PE port E/AEB port

VF3000 VF5000

4: Pilot valve base exhaust

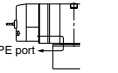

PE port

VF3000 VF5000

Pressure specifications

Nil	Standard (0.7 MPa)
K	High-pressure type (1 MPa)

Rated voltage

DC		AC (50/60 Hz)	
5	24 VDC	1	100 VAC
6	12 VDC	2	200 VAC
		3	110 VAC [115 VAC]
		4	220 VAC [230 VAC]
		7	240 VAC
		B	24 VAC

Made to Order

Refer to page 311 for details.
Combination with low wattage specification is not possible.

Manual override

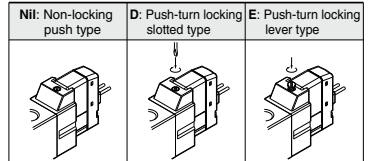

Light/Surge voltage suppressor

Symbol	Light/Surge voltage suppressor	DC	AC
Nil	Without light/surge voltage suppressor	○	○
S	With surge voltage suppressor	○	— (Nil)
Z	With light/surge voltage suppressor	○	○
R	With surge voltage suppressor (Non-polar)	○	—
U	With light/surge voltage suppressor (Non-polar)	○	—

Note) S type is not available with AC mode, since a rectifier prevents surge voltage generation.

* In the DIN terminal type, since a light is installed in the connector, DOZ, DOU, YOZ, YOU are not available.

Caution

When using the surge voltage suppressor type, residual voltage will remain. Refer to page 348 for details.

Electrical entry

Grommet		L-type plug connector		M-type plug connector		DIN terminal	DIN (EN175301-803) terminal	Conduit terminal
G: Lead wire length 300 mm	G: Lead wire length 300 mm	L: With lead wire (length 300 mm)	LN: Without lead wire	M: With lead wire (length 300 mm)	MN: Without lead wire	D: With connector	Y: With connector	T: Conduit terminal
H: Lead wire length 600 mm	H: Lead wire length 600 mm	LO: Without connector		MO: Without connector		DO: Without connector	YO: Without connector	
CE	DC	CE	CE	CE	CE	CE	CE	CE
compliant	compliant	compliant	compliant	compliant	compliant	compliant	compliant	compliant

* LN and MN types are with 2 sockets. * Refer to page 348 when different length of lead wire for L-M type plug connector is required.

* Refer to page 347 for details on the DIN (EN175301-803) terminal.

Note 1) When using IP65, select the main/pilot valve common exhaust or pilot valve base exhaust type.

Note 2) With the same specifications as the DC type, all electrical entries for the 24 VAC type are CE marking compliant.

Manifold Specifications

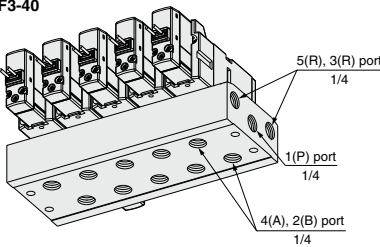
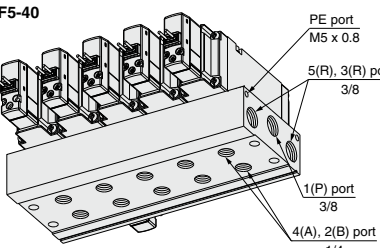
Series	Manifold base model	EXH port type	Applicable valve model	Applicable stations	Manifold base Weight: W [g] Stations: n
VF3000		Common EXH	VF3□40 VF3□43	2 to 20 stations	W = 110n + 116
VF5000		Common EXH	VF5□44	2 to 10 stations	W = 161n + 128

Note) Supply pressure to 1(P) ports and exhaust pressure from R ports on both sides for 10 stations or more (5 stations or more for the VF5000).

How to Order Manifold Assembly

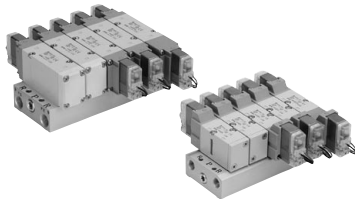

Example (VV5F3-40)

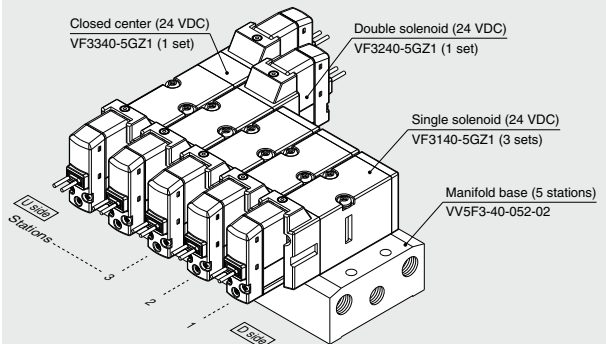

- VV5F3-40-052-02 1 set (Type 40, 5-station manifold base part no.)
- * VF3140-5GZ1 3 sets (Single solenoid part no.)
- * VF3240-5GZ1 1 set (Double solenoid part no.)
- * VF3340-5GZ1 1 set (Closed center part no.)

The asterisk denotes the symbol for assembly. Prefix it to the part nos. of the solenoid valve, etc.

- The valve arrangement is numbered as the 1st station from D side.
- Under the manifold base part number, state the valves to be mounted in order from the 1st station as shown in the figure above. If the arrangement becomes complicated, specify on the manifold specification sheet.

VF3000/5000 Series

Manifold Options

■ For base mounted Blanking plate assembly

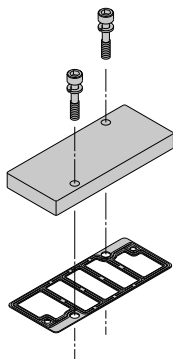

Series	Blanking plate assembly part no.
VF3000	DXT031-38-5A
VF5000	VF5000-70-2A

■ Mounting screw, gasket part no.

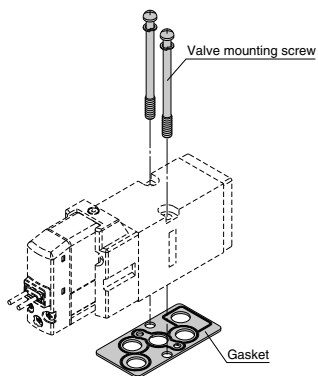

Series	Valve mounting screw (1 pc.)	Gasket
VF3000	Round head combination screw DXT031-44-1 (M4 x 39.5, With spring washer)	DXT031-30-11
VF5000	Hexagon socket head cap screw AXT620-32-1 (M4 x 48, With spring washer)	DXT156-9-8

■ Individual EXH spacer assembly

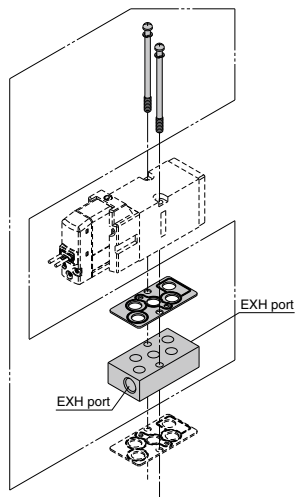

⚠ Caution

Tightening Torque for Mounting Screw

M4: 1.4 N·m

⚠ Warning

When mounting a valve or spacer on the manifold base or sub-plate, etc., the mounting orientation is already decided. If mounted in a wrong direction, the equipment to be connected may result in a malfunction. Refer to the dimensions for mounting.

VF **3** 000-75-2 **A**

Series

Symbol	Series	Port size
3	VF3000	1/8
5	VF5000	1/4

Thread type

NII	Rc
F	G
N	NPT
T	NPTF

Dimensions: VF3000 Series

Type 40/VV5F3-40-□□2-02□: Common exhaust Grommet (G) (H)

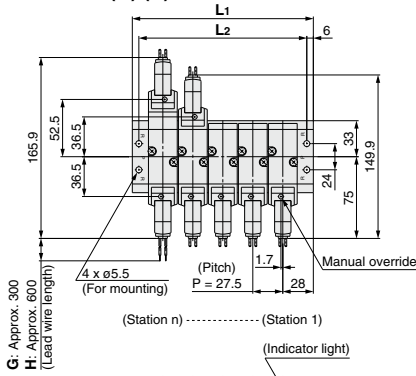

L: Dimensions

n	2	3	4	5	6	7	8	9	10	11	12	13	14
L1	83.5	111	138.5	166	193.5	221	248.5	276	303.5	331	358.5	386	413.5
L2	71.5	99	126.5	154	181.5	209	236.5	264	291.5	319	346.5	374	401.5

n	15	16	17	18	19	20
L1	441	468.5	496	523.5	551	578.5
L2	429	456.5	484	511.5	539	566.5

**Grommet (G) (H)
DC without light/
surge voltage suppressor**

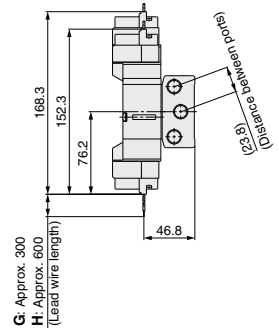

L-type plug connector (L)

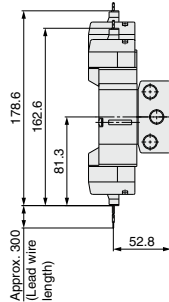

Unless otherwise indicated, dimensions are the same as Grommet (G).

M-type plug connector (M)

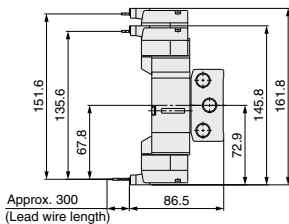

Unless otherwise indicated, dimensions are the same as Grommet (G).

DIN terminal (D) (Y)

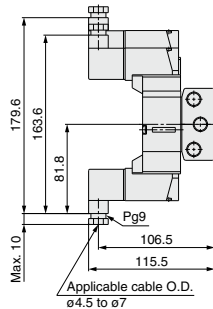

Unless otherwise indicated, dimensions are the same as Grommet (G).

Conduit terminal (T)

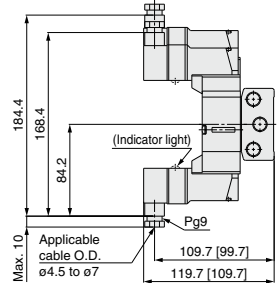

[]: Without indicator light
Unless otherwise indicated, dimensions are the same as Grommet (G).

SV
SYJ
SZ
VF
VP4
VQ 1/2
VQ 4/5
VQC 1/2
VQC 4/5
VQZ
SQ
VFS
VFR
VQ7

VF3000/5000 Series

Dimensions: VF3000 Series

Type 40/VV5F3-40-□□-2-02□: When the individual EXH spacer (VF3000-75-2A) is mounted.

Grommet (G) (H)

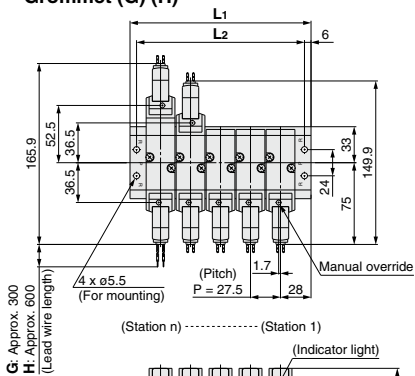

Grommet (G) (H) DC without light/ surge voltage suppressor

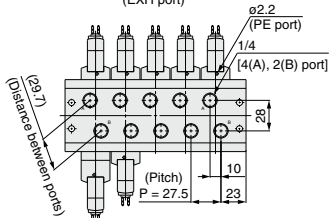
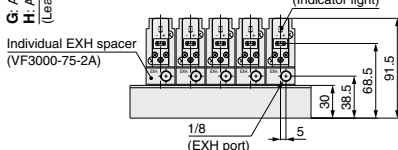
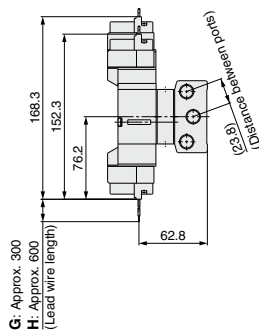

L: Dimensions

n	2	3	4	5	6	7	8	9	10	11	12	13	14
L1	83.5	111	138.5	166	193.5	221	248.5	276	303.5	331	358.5	386	413.5
L2	71.5	99	126.5	154	181.5	209	236.5	264	291.5	319	346.5	374	401.5

n	15	16	17	18	19	20
L1	441	468.5	496	523.5	551	578.5
L2	429	456.5	484	511.5	539	566.5

L-type plug connector (L)

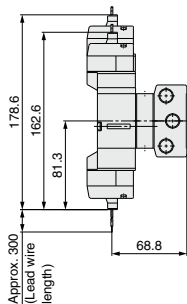

Unless otherwise indicated, dimensions are the same as Grommet (G).

M-type plug connector (M)

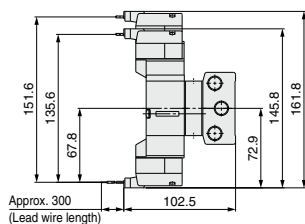

Unless otherwise indicated, dimensions are the same as Grommet (G).

DIN terminal (D) (Y)

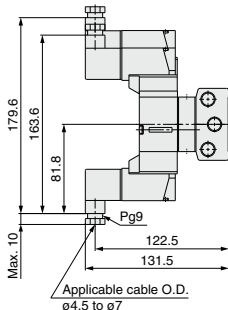

Unless otherwise indicated, dimensions are the same as Grommet (G).

Conduit terminal (T)

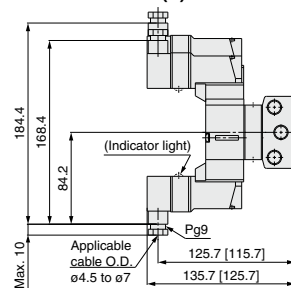

[]: Without indicator light
Unless otherwise indicated, dimensions are the same as Grommet (G).

Dimensions: VF5000 Series

Type 40/VV5F5-40-□□-2-02□: Common exhaust Grommet (G)

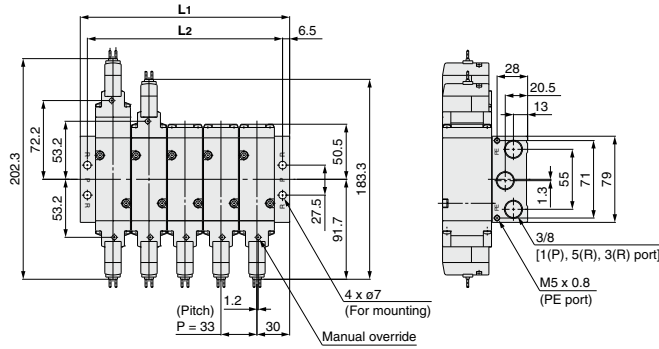

(Station n) (Station 1)

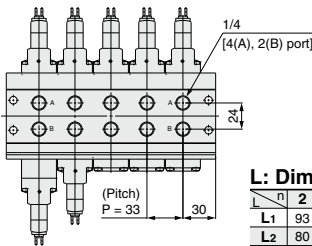
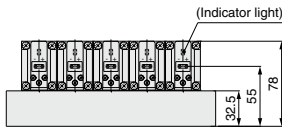

L: Dimensions

	n	2	3	4	5	6	7	8	9	10
L1	93	126	159	192	225	258	291	324	357	
L2	80	113	146	179	212	245	278	311	344	

Grommet (G) (H)

DC without light/
surge voltage suppressor

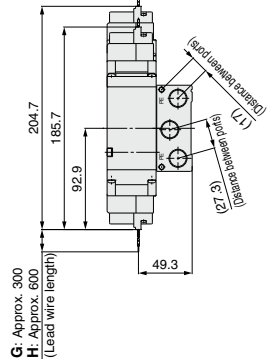

G: Approx. 300
H: Approx. 600
(Lead wire length)

L-type plug connector (L)

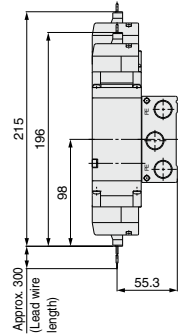

Unless otherwise indicated, dimensions are the same as Grommet (G).

M-type plug connector (M)

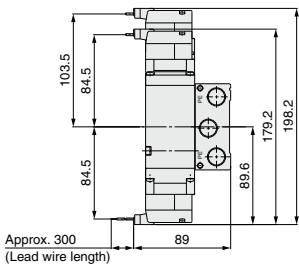

Approx. 300
(Lead wire length)

Unless otherwise indicated, dimensions are the same as Grommet (G).

DIN terminal (D) (Y)

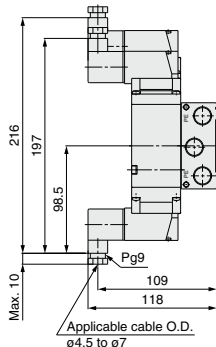

Unless otherwise indicated, dimensions are the same as Grommet (G).

Conduit terminal (T)

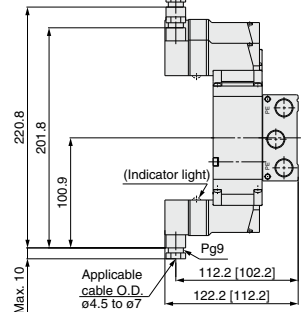

[]: Without indicator light
Unless otherwise indicated, dimensions are the same as Grommet (G).

SV
SYJ
SZ
VF
VP4
VQ 1/2
VQ 4/5
VQC 1/2
VQC 4/5
VQZ
SQ
VFS
VFR
VQ7

VF3000/5000 Series

Dimensions: VF5000 Series

Type 40/VV5F5-40-□□-2-02□: When the individual EXH spacer (VF5000-75-2A) is mounted.
 Grommet (G)

Grommet (G) (H)
 DC without light/
 surge voltage suppressor

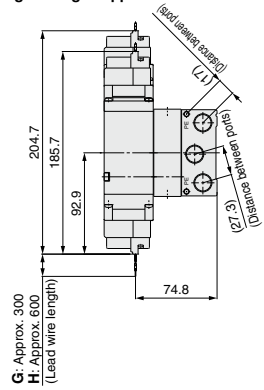
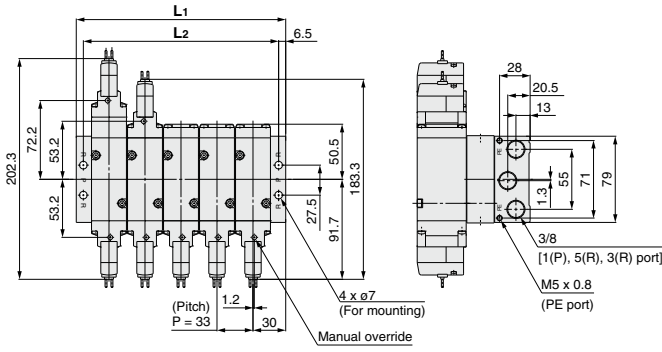

(Station n) (Station 1)

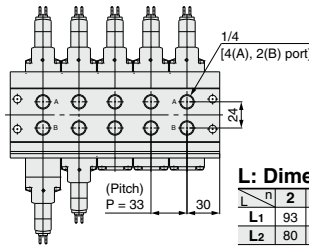
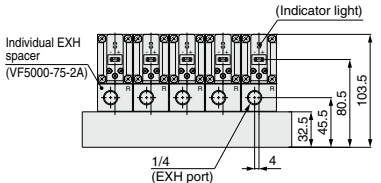

L-type plug connector (L)

L: Dimensions

n	2	3	4	5	6	7	8	9	10
L1	93	126	159	192	225	258	291	324	357
L2	80	113	146	179	212	245	278	311	344

Unless otherwise indicated, dimensions are the same as Grommet (G).

M-type plug connector (M)

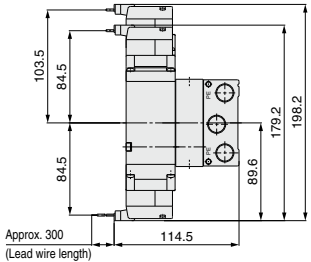

DIN terminal (D) (Y)

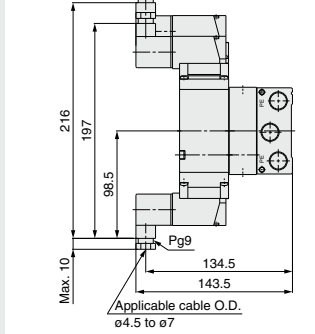

Conduit terminal (T)

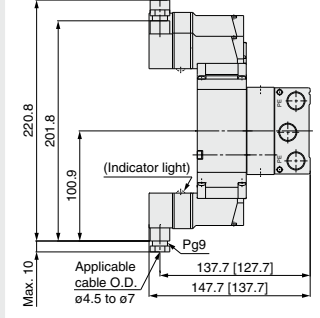

Unless otherwise indicated, dimensions are the same as Grommet (G).

Unless otherwise indicated, dimensions are the same as Grommet (G).

[]: Without indicator light
 Unless otherwise indicated, dimensions are the same as Grommet (G).



VF Series

Specific Product Precautions 1

Be sure to read this before handling the products.

Refer to back page 50 for Safety Instructions and pages 3 to 9 for 3/4/5 Port Solenoid Valve Precautions.

Manual Override

⚠ Warning

Regardless of an electric signal for the solenoid valve, the manual override is used for switching the main valve. Connected actuator is started by manual operation. Use the manual override after confirming that there is no danger.

■ Non-locking push type

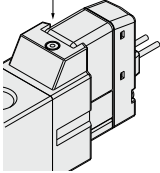

Push down on the manual override with a small screwdriver until it stops. Release the screwdriver and the manual override will return.

■ Push-turn locking slotted type

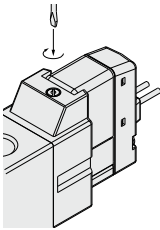

Locked position

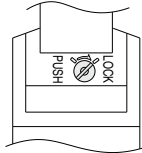

Push down on the manual override with a small flat head screwdriver until it stops. Turn it clockwise by 90° to lock it. Turn it counterclockwise to release it.

■ Push-turn locking lever type

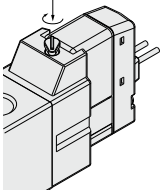

Locked position

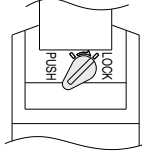

After pushing down, turn in the direction of the arrow. If it is not turned, it can be operated the same way as the non-locking push type.

⚠ Caution

When locking the manual override on the push-turn locking type (D or E type), be sure to push it down before turning. Turning without first pushing it down can cause damage to the manual override and other trouble such as air leakage, etc. Do not apply excessive torque when turning the locking type manual override. (0.1 N·m)

How to Use L/M-Type Plug Connector

⚠ Caution

1. Connector attachment/detachment

- To attach a connector, hold the lever and connector unit between your fingers and insert straight onto the pins of the solenoid valve so that the lever's pawl is pushed into the groove and locks.
- To detach a connector, remove the pawl from the groove by pushing the lever downward with your thumb, and pull the connector straight out.

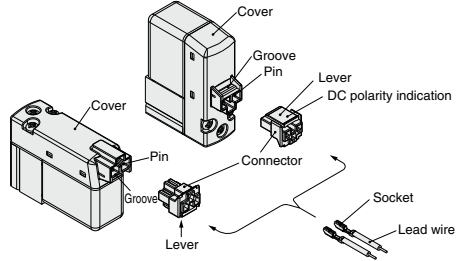

2. Crimping lead wire and socket connection

Not necessary if ordering the lead wire pre-connected model. Strip 3.2 to 3.7 mm at the end of the lead wires, insert the ends of the core wires evenly into the sockets, and then crimp with a crimping tool. When this is done, take care that the coverings of the lead wires do not enter the core wire crimping area. (Please contact SMC for details on the crimping tool.)

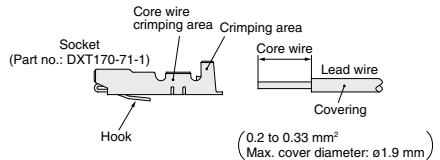

3. Socket with lead wire attachment/detachment

• Attachment

Insert the sockets into the square holes of the connector (with +, - indication), and continue to push the sockets all the way in until they lock by hooking into the seats in the connector. (When they are pushed in, their hooks open and they are locked automatically.) Then, confirm that they are locked by pulling lightly on the lead wires.

• Detachment

To detach a socket from a connector, pull out the lead wire while pressing the socket's hook with a stick having a thin tip (approx. 1 mm). If the socket will be used again, first spread the hook outward.

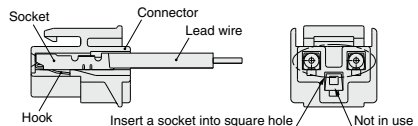

SV

SYJ

SZ

VF

VP4

VQ

1/2

VQ

4/5

VQC

1/2

VQC

4/5

VQZ

SQ

VFS

VFR

VQ7



VF Series

Specific Product Precautions 2

Be sure to read this before handling the products.

Refer to back page 50 for Safety Instructions and pages 3 to 9 for 3/4/5 Port Solenoid Valve Precautions.

Plug Connector Lead Wire Length

⚠ Caution

Plug connector lead wires have a standard length of 300 mm, however, the following lengths are also available.

How to Order Connector Assembly

DC	: V200-30-4A-	
100 VAC	: V200-30-1A-	
200 VAC	: V200-30-2A-	
Other AC voltages	: V200-30-3A-	

Without lead wire : V200-30-A
(With a connector and 2 sockets)

● Lead wire length

Nil	300 mm
6	600 mm
10	1000 mm
15	1500 mm
20	2000 mm
25	2500 mm
30	3000 mm
50	5000 mm

How to Order

Specify the connector assembly part number together with the part number for the plug connector type solenoid valve without connector.

(Example) Lead wire length: 2000 mm

DC	AC
VF3130-5LO1-02	VF3130-1LO1-02
V200-30-4A-20	V200-30-1A-20

How to Use DIN Terminal Connector

The DIN terminal with an IP65 (enclosure) is protected against dust and water, however, it must not be used in water.

⚠ Caution

Connection

- 1) Loosen the set screw and pull the connector out of the solenoid valve terminal block.
- 2) After removing the set screw, insert a flat head screwdriver, etc. into the notch on the bottom of the terminal block and pry it open, separating the terminal block and the housing.
- 3) Loosen the terminal screws on the terminal block, insert the core of the lead wire into the terminal, and attach securely with the terminal screws.

In addition, when using the DC mode type with a surge voltage suppressor (polar: S and Z types), connect wires corresponding to the polarity (+ or -) that is printed on the terminal block.

- 4) Secure the cord by fastening the ground nut.

In the case of connecting wires, select cable cords carefully because if those out of the specified range ($\phi 4.5$ to $\phi 7$) are used, it will not be able to satisfy IP65 (enclosure).

Tighten the ground nut and set screw within the specified range of torque.

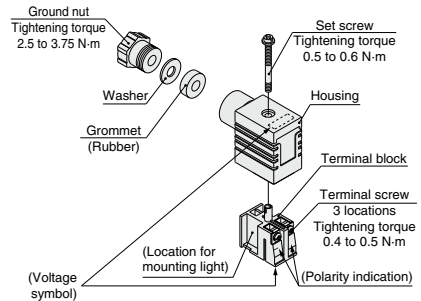

* Refer to page 347 for the DIN connector part no.

Changing the entry direction

After separating the terminal block and housing, the cord entry direction can be changed by attaching the housing in the opposite direction.

* Make sure not to damage elements, etc., with the lead wires of the cord.

Precautions

Plug in and pull out the connector vertically without tilting to one side.

Applicable cable

Cable O.D.: $\phi 4.5$ to $\phi 7$

(Reference) 0.5 mm^2 to 1.5 mm^2 , 2-core or 3-core, equivalent to JIS C 3306

Applicable crimped terminal

O terminal: R1.25-4M that is specified in JIS C 2805

Y terminal: 1.25-3L, which is released by JST Mfg. Co., Ltd.

Stick terminal: Size 1.5 or shorter



VF Series

Specific Product Precautions 3

Be sure to read this before handling the products.

Refer to back page 50 for Safety Instructions and pages 3 to 9 for 3/4/5 Port Solenoid Valve Precautions.

DIN (EN175301-803) Terminal

Y type DIN terminal corresponds to the DIN connector with terminal pitch 10 mm, which complies with EN175301-803B. Since the terminal pitch is different from the D type DIN connector, these two types are not interchangeable.

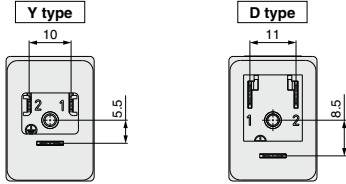

How to Order DIN Connector

⚠ Caution

● Without indicator light

DC, AC, Common to all voltages: V200--1

● With indicator light

DC

Polar type (□Z) : V200--3--1

Non-polar type (□U) : V200--5--1

AC (□Z) : V200--7--1

Connector specifications

	D type	Y type	Rated voltage
61	01	02	100/110 VAC [115 VAC]
63	02	07	200/220 VAC [230 VAC]
			240 VAC

Note) For 24 VAC, the part no. is V200-61-5-B.
63

Circuit diagram with light (Built-in connector)

DC (□Z) circuit diagram

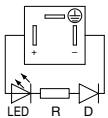

LED: Light emitting diode
D: Protective diode
R: Resistor

AC (□Z) circuit diagram

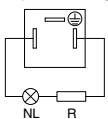

NL: Neon light, R: Resistor

DC (□U) circuit diagram

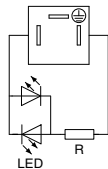

LED: Light emitting diode
R: Resistor

Note) The 24 VAC specification is the same as those in the DC (□U) circuit diagram.

How to Use Conduit Terminal

⚠ Caution

Connection

- Loosen the set screw and remove the terminal block cover from the terminal block.
- Loosen the terminal screws on the terminal block, insert the core of the lead wire or crimped terminal into the terminal, and attach securely with the terminal screws.

In addition, when using the DC mode type with a surge voltage suppressor (polar: S and Z types), connect wires to terminal 1 and 2 corresponding to the polarity (+ or -) as shown on the right figure.



In the case of connecting wires, select cable cords carefully because if those out of the specified range ($\phi 4.5$ to $\phi 7$) are used, it will not be able to satisfy IP65 (enclosure).

Tighten the ground nut and set screw within the specified range of torque.

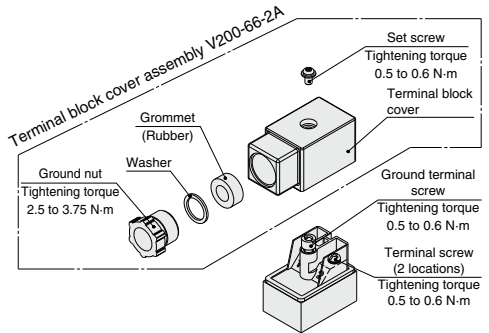

Applicable cable

Cable O.D.: $\phi 4.5$ to $\phi 7$

(Reference) 0.5 mm^2 to 1.5 mm^2 , 2-core or 3-core, equivalent to JIS C 3306

Applicable crimped terminal

O terminal: Equivalent to R1.25-3 that is specified in JIS C 2805
Y terminal: Equivalent to 1.25-3, which is released by JST Mfg. Co., Ltd.

* Use O terminal when a ground terminal is used.

SV

SQ

SZ

VF

VP4

VQ

1/2

VQ

4/5

VQC

1/2

VQC

4/5

VQZ

SQ

VFS

VFR

VQ7



VF Series

Specific Product Precautions 4

Be sure to read this before handling the products.

Refer to back page 50 for Safety Instructions and pages 3 to 9 for 3/4/5 Port Solenoid Valve Precautions.

Light/Surge Voltage Suppressor

⚠ Caution

<DC>

■ Polar type

With surge voltage suppressor (□S) Polarity protection diode

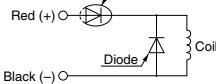

● Grommet or L/M-type plug connector

With light/surge voltage suppressor (□Z)

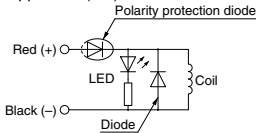

● DIN or Conduit terminal

With light/surge voltage suppressor (□Z)

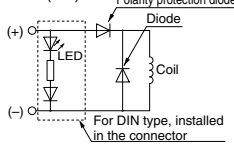

■ Non-polar type

With surge voltage suppressor (□R)

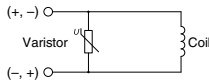

● Grommet or L/M-type plug connector

With light/surge voltage suppressor (□U)

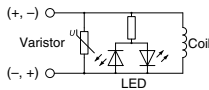

● DIN or Conduit terminal

With light/surge voltage suppressor (□U)

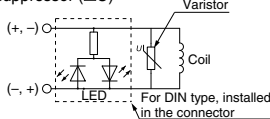

- Please connect correctly the lead wires to + (positive) and - (negative) indications on the connector. (For non-polar type, the lead wires can be connected to either one.)
- When the valve with polarity protection diode is used, the voltage will drop by approx. 1 V. Therefore, pay attention to the allowable voltage fluctuation (For details, refer to the solenoid specifications of each type of valve).
- Solenoids, whose lead wires have been pre-wired: + (positive) side red and - (negative) side black.

■ With power saving circuit

Power consumption is decreased by approx. 1/3 by reducing the wattage required to hold the valve in an energized state. (Effective energizing time is over 40 ms at 24 VDC.)

Refer to the electrical power waveform as shown below.

<Electrical power waveform of energy saving type>

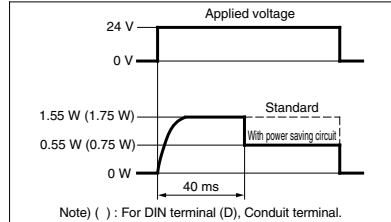

- Since the voltage will drop by approx. 0.5 V due to the transistor, pay attention to the allowable voltage fluctuation. (For details, refer to the solenoid specifications of each type of valve.)

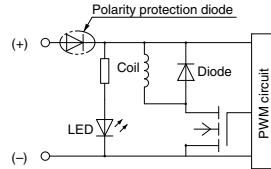

<AC>

S type is not available, since a rectifier prevents surge voltage generation.

● Grommet or L/M-type plug connector

With light/surge voltage suppressor (□Z)

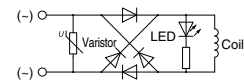

● DIN or Conduit terminal

With light/surge voltage suppressor (□Z)

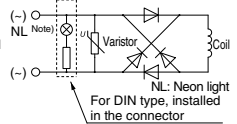

Note) LED for 24 VAC.

Residual voltage of the surge voltage suppressor

Note) If a varistor or diode surge voltage suppressor is used, there is some residual voltage to the protection element and rated voltage. Therefore, refer to the table below and pay attention to the surge voltage protection on the controller side. Also, since the response time does change, refer to the specifications on pages 299 and 313.

Residual Voltage

Surge voltage suppressor	DC		AC
	24 V	12 V	
S, Z	Approx. 1 V		Approx. 1 V
R, U	Approx. 47 V	Approx. 32 V	—

Continuous Duty

For applications such as mounting a valve on a control panel, incorporate measure to limit the heat radiation so that it is within the operating temperature range. Furthermore, do not touch it while it is being energized or right after it is energized.



VF Series

Specific Product Precautions 5

Be sure to read this before handling the products.

Refer to back page 50 for Safety Instructions and pages 3 to 9 for 3/4/5 Port Solenoid Valve Precautions.

One-touch Fittings Precautions

⚠ Caution

When fittings are used, they may interfere with one another depending on their types and sizes. Therefore, the dimensions of the fittings to be used should first be confirmed in their respective catalogs.

Fittings whose compliance with the VF series is already confirmed are stated below. If the fitting within the applicable range is selected, there will not be any interference.

Applicable Fittings: KQ2H, KQ2S Series

Series	Model	Piping port	Port size	Applicable tubing O.D.						
				ø3.2	ø4	ø6	ø8	ø10	ø12	ø16
VF1000	VF1□20-□□1-M5	4(A), 2(B)	M5	██████████						
		5(EA), 3(EB)	M5	██████████						
	VF1□20-□□1-01	4(A), 2(B)	1/8	██████████						
		5(EA), 3(EB)	M5	██████████						
	VF1□3□-□□1-M5	4(A), 2(B)	M5	██████████						
	VF1□3□-□□1-01	4(A), 2(B)	1/8	██████████						
	Type 30 manifold base	1(P), 5/3(R)	1/8	██████████						
Type 31 manifold base	1(P)	1/8	██████████							
	5(EA), 3(EB)	M5	██████████							

Series	Model	Piping port	Port size	Applicable tubing O.D.					
				ø3.2	ø4	ø6	ø8	ø10	ø12
VF3000	VF3□3□-□□1-01	4(A), 2(B)	1/8	██████████					
		1(P), 5(EA), 3(EB)	1/8	██████████					
	VF3□3□-□□1-02	4(A), 2(B)	1/4	██████████					
		1(P), 5(EA), 3(EB)	P: 1/4, EA, EB: 1/8	██████████					
	VF3□4□-□□1-02	4(A), 2(B)	1/4	██████████					
		1(P), 5(EA), 3(EB)	1/4	██████████					
	VF3□4□-□□1-03	4(A), 2(B)	3/8		██████████				
		1(P), 5(EA), 3(EB)	3/8		██████████				
	Type 30 manifold base	1(P), 5(R), 3(R)	1/4	██████████					
Type 40 manifold base	4(A), 2(B)	1/4	██████████						
	1(P), 5(R), 3(R)	1/4	██████████						

Series	Model	Piping port	Port size	Applicable tubing O.D.					
				ø3.2	ø4	ø6	ø8	ø10	ø12
VF5000	VF5□2□-□□1-02	4(A), 2(B)	1/4	██████████					
		1(P), 5(EA), 3(EB)	1/4	██████████					
	VF5□2□-□□1-03	4(A), 2(B)	3/8		██████████				
		1(P), 5(EA), 3(EB)	3/8		██████████				
	VF5□44-□□1-02	4(A), 2(B)	1/4	██████████					
		1(P), 5(EA), 3(EB)	1/4	██████████					
	VF5□44-□□1-03	4(A), 2(B)	3/8		██████████				
		1(P), 5(EA), 3(EB)	3/8		██████████				
	VF5□44-□□1-04	4(A), 2(B)	1/2			██████████			
		1(P), 5(EA), 3(EB)	1/2			██████████			
	Type 20 manifold base	1(P), 5(R), 3(R)	3/8		██████████				
	Type 21 manifold base	1(P), 5(R), 3(R)	1/2			██████████			
	Type 40 manifold base	4(A), 2(B)	1/4	██████████					
1(P), 5(R), 3(R)		3/8		██████████					

SV
 SYJ
 SZ
 VF
 VP4
 VQ 1/2
 VQ 4/5
 VQC 1/2
 VQC 4/5
 VQZ
 SQ
 VFS
 VFR
 VQ7



Low Wattage Specification (VF1000/3000) Specific Product Precautions 6

Be sure to read this before handling the products.

Refer to back page 50 for Safety Instructions and pages 3 to 9 for 3/4/5 Port Solenoid Valve Precautions.

Manual Override

⚠ Warning

1. Non-locking push type [Standard]

Press in the direction of the arrow.

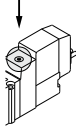

2. Push-turn locking slotted type [D type]

After pushing down, turn in the direction of the arrow. If it is not turned, it can be operated the same way as the non-locking push type.

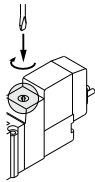

Locked position



⚠ Caution

When operating the D type, use a watchmakers' screwdriver and turn lightly.

[Torque: Less than 0.1 N·m]

3. Push-turn locking lever type [E type]

After pushing down, turn in the direction of the arrow. If it is not turned, it can be operated the same way as the non-locking push type.

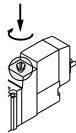

Locked position



⚠ Caution

When locking the manual override with the push-turn locking type (D or E type), be sure to push it down before turning.

Turning without first pushing it down can cause damage to the manual override and other trouble such as air leakage, etc.

Solenoid Valve for 200/220 VAC Specification

⚠ Warning

AC specification solenoid valves with grommet or L/M-type plug connector have a built-in rectifier circuit in the pilot section to operate the DC coil. With 200/220VAC specification pilot valves, this built-in rectifier generates heat when energized. The surface may become hot depending on the energized condition; therefore, do not touch the solenoid valves.

How to Use L/M-Type Plug Connector

⚠ Caution

1. Connector attachment/detachment

- To attach a connector, hold the lever and connector unit between your fingers and insert straight onto the pins of the solenoid valve so that the lever's pawl is pushed into the groove and locks.
- To detach a connector, remove the pawl from the groove by pushing the lever downward with your thumb, and pull the connector straight out.

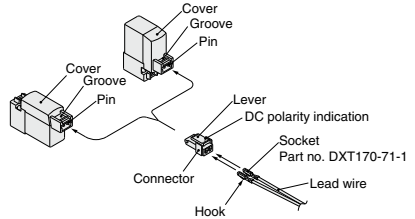

2. Crimping lead wire and socket connection

Strip 3.2 to 3.7 mm at the end of the lead wires, insert the ends of the core wires evenly into the sockets, and then crimp with a crimping tool. When this is done, take care that the coverings of the lead wires do not enter the core wire crimping area.

(Please contact SMC for the dedicated crimping tools.)

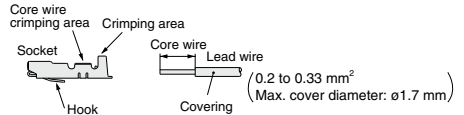

3. Socket with lead wire attachment/detachment

• Attachment

Insert the sockets into the square holes of the connector (with +, - indication), and continue to push the sockets all the way in until they lock by hooking into the seats in the connector. (When they are pushed in, their hooks open and they are locked automatically.) Then, confirm that they are locked by pulling lightly on the lead wires.

• Detachment

To detach a socket from a connector, pull out the lead wire while pressing the socket's hook with a stick having a thin tip (approx. 1 mm). If the socket will be used again, first spread the hook outward.

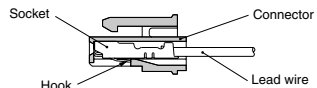



Low Wattage Specification (VF1000/3000) Specific Product Precautions 7

Be sure to read this before handling the products.

Refer to back page 50 for Safety Instructions and pages 3 to 9 for 3/4/5 Port Solenoid Valve Precautions.

Plug Connector Lead Wire Length

⚠ Caution

Plug connector lead wires have a standard length of 300 mm, however, the following lengths are also available.

How to Order Connector Assembly

DC: **SY100-30-4A** - []

100 VAC: **SY100-30-1A** - []

200 VAC: **SY100-30-2A** - []

Other AC voltages: **SY100-30-3A** - []

Without lead wire: **SY100-30-A**

(With a connector and 2 sockets)

How to Order

Specify the connector assembly part number together with the part number for the plug connector type solenoid valve without connector.

(Example) Lead wire length: 2000 mm

DC	AC
VF3130Y-5LO1-02	VF3130Y-1LO1-02
SY100-30-4A-20	SY100-30-1A-20

Lead wire length

Nil	300 mm
6	600 mm
10	1000 mm
15	1500 mm
20	2000 mm
25	2500 mm
30	3000 mm
50	5000 mm

Light/Surge Voltage Suppressor

⚠ Caution

1. L/M-type plug connector

<DC>

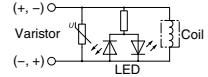

<AC>

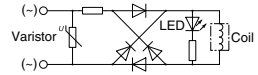

2. DIN terminal

<DC>

With surge voltage suppressor (DS, DOS, YS, YOS)

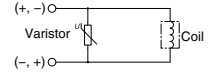

With light/surge voltage suppressor (DZ, YZ)

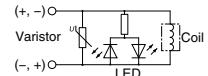

<AC>

With indicator light (DZ, YZ)

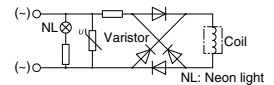

Note) If a varistor surge voltage suppressor is used, there is some residual voltage to the protection element and rated voltage. Therefore, pay attention to the surge voltage protection on the controller side.

SV

SYJ

SZ

VF

VP4

VQ
1/2

VQ
4/5

VQC
1/2

VQC
4/5

VQZ

SQ

VFS

VFR

VQ7



Low Wattage Specification (VF1000/3000) Specific Product Precautions 8

Be sure to read this before handling the products.

Refer to back page 50 for Safety Instructions and pages 3 to 9 for 3/4/5 Port Solenoid Valve Precautions.

How to Use DIN Terminal

1. ISO#: Conforming to EN-175301-803C (former DIN 43650C) (Distance between pins: 8 mm)

The DIN terminal type with an IP65 (enclosure) is protected against dust and water, however, it must not be used in water.

2. Connection

- Loosen the set screw and pull the connector out of the solenoid valve terminal block.
- After removing the set screw, insert a flat head screwdriver, etc. into the notch on the bottom of the terminal block and pry it open, separating the terminal block and the housing.
- Loosen the terminal screws (slotted head screw) on the terminal block, insert the core of the lead wire into the terminal according to wiring connection, and attach securely with the terminal screws.
- Tighten the ground nut to secure the wire.

3. Changing the entry direction

After separating the terminal block and housing, the cord entry direction can be changed by attaching the housing in a different direction (four directions at 90° intervals).

* Make sure not to damage a light, etc., with the lead wires of the cord.

4. Precautions

Plug in and pull out the connector vertically without tilting to one side.

5. Applicable cable

Cable O.D: $\phi 3.5$ to $\phi 7$

(Reference) 0.5 mm², 2-core or 3-core, equivalent to JIS C 3306

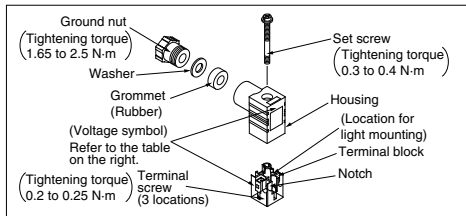

DIN Connector Part No.

⚠ Caution

DIN terminal (D)

Without indicator light	SY100-61-1
-------------------------	------------

With indicator light

Rated voltage	Voltage symbol	Part no.
24 VDC	24 V	SY100-61-3-05
12 VDC	12 V	SY100-61-3-06
100 VAC	100 V	SY100-61-2-01
200 VAC	200 V	SY100-61-2-02
110 VAC	110 V	SY100-61-2-03
220 VAC	220 V	SY100-61-2-04

DIN terminal (Y)

Without indicator light

Rated voltage	Voltage symbol	Part no.
Common to all voltages	None	SY100-82-1

With indicator light

Rated voltage	Voltage symbol	Part no.
24 VDC	24 V	SY100-82-3-05
12 VDC	12 V	SY100-82-3-06
100 VAC	100 V	SY100-82-2-01
200 VAC	200 V	SY100-82-2-02
110 VAC (115VAC)	110 V	SY100-82-2-03
220 VAC (230 VAC)	220 V	SY100-82-2-04

Circuit diagram with light

AC circuit diagram

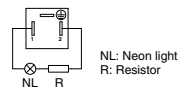

DC circuit diagram

