

180° Angular Type Air Gripper

MHY2/MHW2 Series

ø10, ø16, ø20, ø25

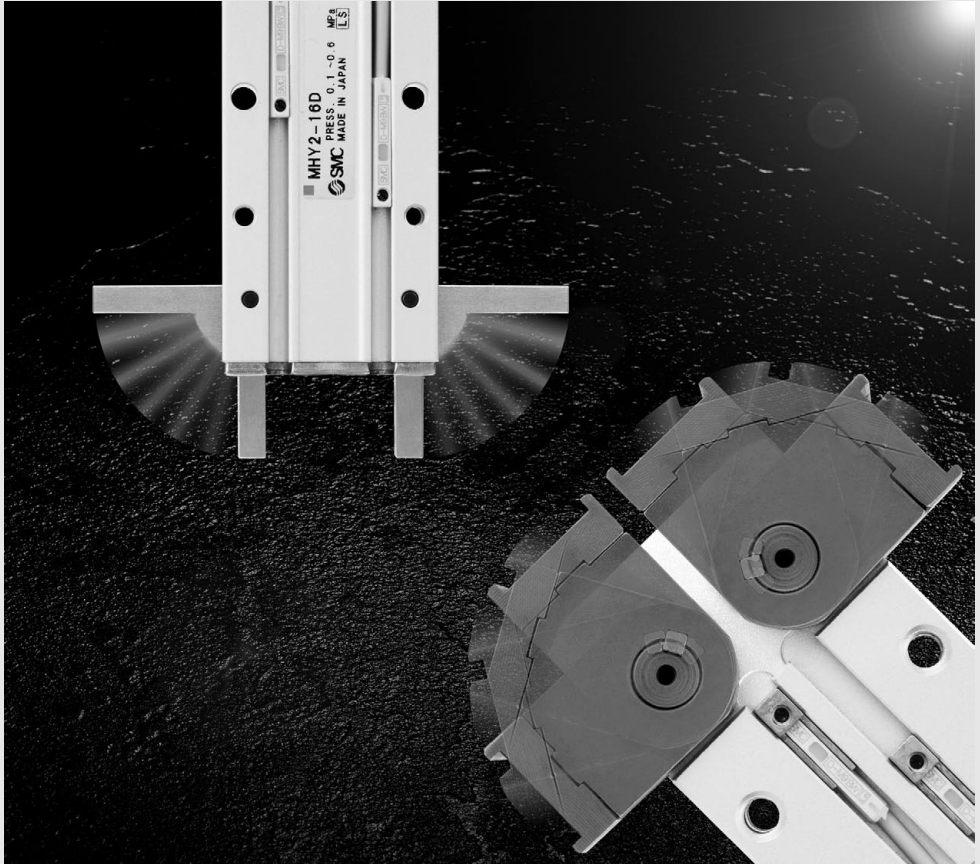

- MHZ
- MHF
- MHL
- MHR
- MHK
- MHS
- MHC
- MHT
- MHY**
- MHW**
- XC□
- MRHQ
- MA
- D-□

180° Angular Type Air Gripper

Cam Type

Rack & Pinion Type

MHY2/MHW2 Series

MHY2 Series/Cam Type

Light and compact size in small bore sizes

Model	Bore size (mm)	Gripping moment * (N-m)	Over length L (mm)	Weight (g)
MHY2-10D	10	0.16	71	70
MHY2-16D	16	0.54	84	150
MHY2-20D	20	1.10	106	320
MHY2-25D	25	2.28	131	560

* At the pressure of 0.5 MPa

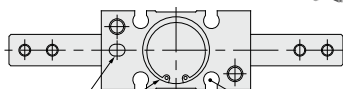

Improved mounting repeatability

Auto switch mounting at 4 locations

Resistance to dusty environments

Reduced opening sizes helps prevent foreign objects from entering.

Stainless steel fingers are standard.

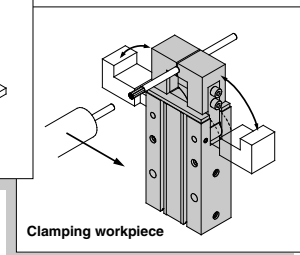
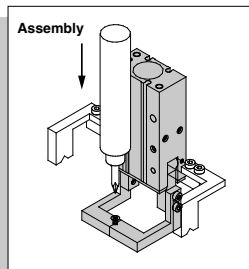
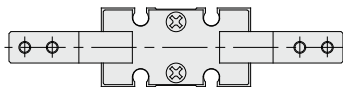
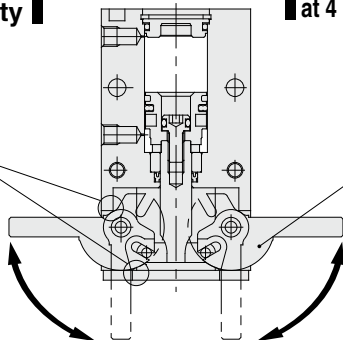

Series Variations

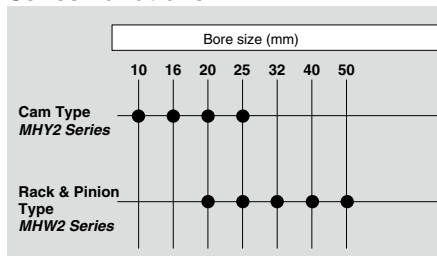

MHW2 Series/Rack & Pinion Type

Unique seal design allows shorter total length construction and constant gripping force when opening and closing fingers. (PAT.PEND)

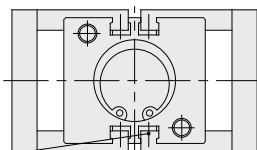

Model	Bore size (mm)	Gripping moment* (N-m)	Over length L(mm)	Weight (g)
MHW2-20D	20	0.30	68	300
MHW2-25D	25	0.73	78	510
MHW2-32D	32	1.61	93.5	905
MHW2-40D	40	3.70	117.5	2135
MHW2-50D	50	8.27	154	5100

* At the pressure of 0.5 MPa

Auto switch mounting at 4 locations

Key connection is ideal for impact resistance.

Key connection between finger and shaft prevents finger angle slippage during impact.

Two finger types available.

Flat finger type

Right angle finger type

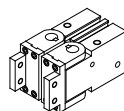
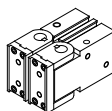

Dustproof construction

Seal arrangement protects gripper from harsh dusty environments.

Bearings are standard.

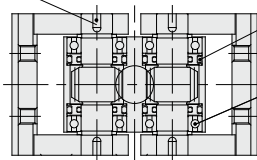
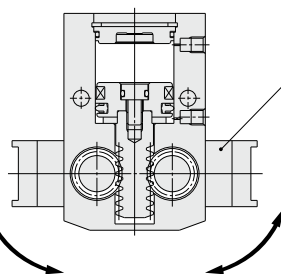

Clamping workpiece

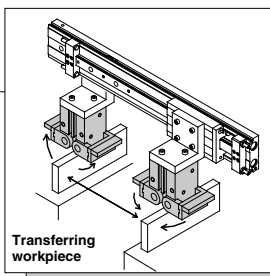
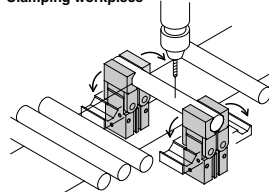

Transferring workpiece

INDEX

Applicable auto switch

Page

Solid state switch
D-M9/M9□W type

704 to 710

711 to 718

MHZ

MHF

MHL

MHR

MHK

MHS

MHC

MHT

MHY

MHW

-X□

MRHQ

MA

D-□

MHY2/MHW2 Series Model Selection

Model Selection

Selection Procedure



Step 1 Confirmation of Gripping Force

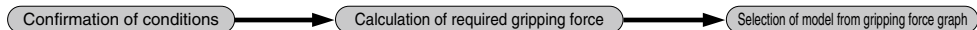

Example

Workpiece mass: 0.05 kg

Guidelines for the selection of the gripper with respect to workpiece mass

- Although conditions differ according to the workpiece shape and the coefficient of friction between the attachments and the workpiece, select a model that can provide a gripping force of 10 to 20 times the workpiece mass, or more.
- If high acceleration, deceleration or impact forces are encountered during motion, a further margin of safety should be considered.

Example) For setting the gripping force to be at least 20 times the work weight;

$$\text{Required gripping force} = 0.05 \text{ kg} \times 20 \times 9.8 \text{ m/s}^2 = 10 \text{ N min.}$$

Gripping point L = 35 mm

Operating pressure: 0.4 MPa

MHY2-16D

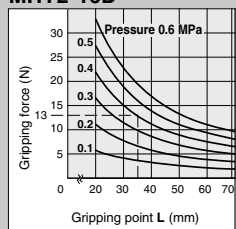

- When **MHY2-16D** is selected, the gripping force is determined to be 13 N according to the gripping point distance (L = 35 mm) and the pressure (0.4 MPa).

- The gripping force is 26 times the workpiece mass and therefore satisfies a gripping force setting value of 20 times or more.

Effective Gripping Force

MHY2/MHW2 Series Double Acting

- Indication of effective gripping force
The effective gripping force shown in the graphs to the right is expressed as F, which is the impellent force of one finger, when both fingers and attachments are in full contact with the workpiece as shown in the figure below.

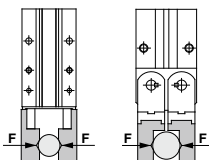

External grip

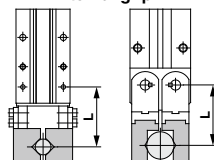

MHY2-10D

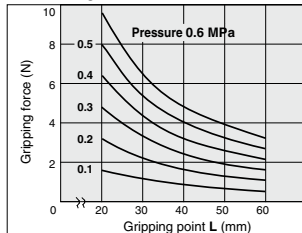

MHY2-20D

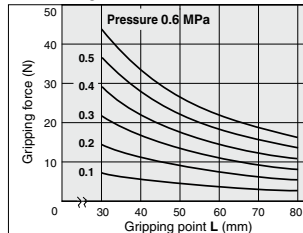

MHY2-16D

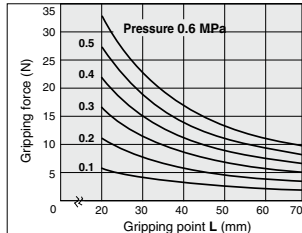

MHY2-25D

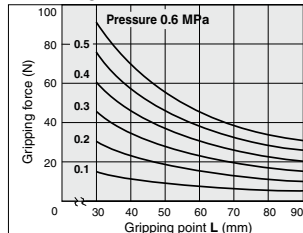

MHW2-20D

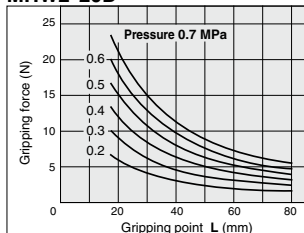

MHW2-32D

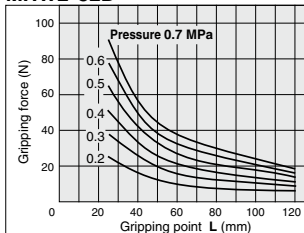

MHW2-50D

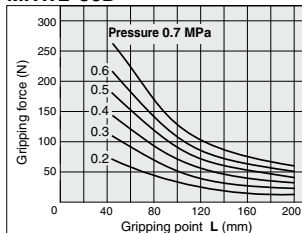

MHW2-25D

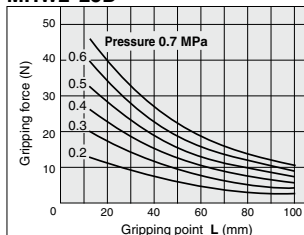

MHW2-40D

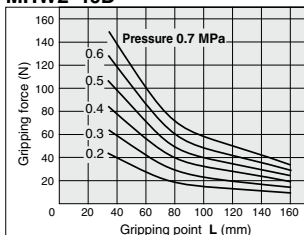

Step 2 Confirmation of Gripping Point

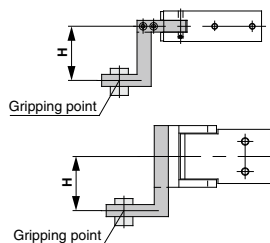

MHY

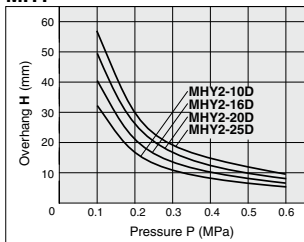

MHW

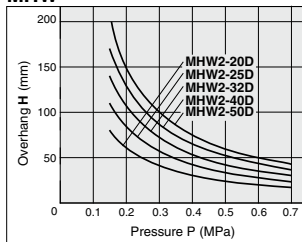

- Workpiece should be held at a point within the range of overhanging distance (H) for a given pressure indicated in the tables on the right.
- When the workpiece is held at a point outside of the recommended range for a given pressure, it may cause adverse effect on the product life.

MHZ
MHF
MHL
MHR
MHK
MHS
MHC
MHT
MHY
MHW
-X <input type="checkbox"/>
MRHQ
MA
D- <input type="checkbox"/>

MHY2/MHW2 Series Model Selection

Step 3 Confirmation of Moment of Inertia of Attachments

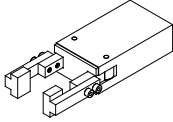

Confirm the moment of inertia for the attachment at one side.
Calculate the moment of inertia for A and B separately as shown in the figures on the right.

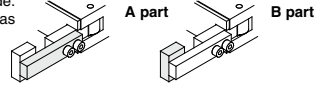

Procedure	Calculation	Calculation example
1. Check the operating conditions, dimensions of attachment, etc.	<p>A part</p> <p>B part</p>	<p>Operating model: MHY2-16D Opening time: 0.15 s a = 40 (mm) b = 7 (mm) c = 8 (mm) d = 5 (mm) e = 10 (mm) f = 12 (mm)</p>
2. Calculate the moment of inertia of attachment.	<p>A part</p> <p>Calculation of weight $m_1 = a \times b \times c \times \text{Specific gravity}$</p> <p>Moment of inertia around Z1 axis $I_{z1} = \{m_1(a^2 + b^2)/12\} \times 10^{-6}$</p> <p>Moment of inertia around Z axis $I_A = I_{z1} + m_1 r_1^2 \times 10^{-6}$</p> <p>B part</p> <p>Calculation of weight $m_2 = d \times e \times f \times \text{Specific gravity}$</p> <p>Moment of inertia around Z2 axis $I_{z2} = \{m_2(d^2 + e^2)/12\} \times 10^{-6}$</p> <p>Moment of inertia around Z axis $I_B = I_{z2} + m_2 r_2^2 \times 10^{-6}$</p> <p>Total moment of inertia $I = I_A + I_B$ (* Constant for unit conversion)</p>	<p>Material of attachment: Aluminum alloy (Specific gravity = 2.7) r₁ = 37 (mm)</p> <p>m₁ = $40 \times 7 \times 8 \times 2.7 \times 10^{-6}$ = 0.006 (kg)</p> <p>I_{z1} = $\{0.006 \times (40^2 + 7^2)/12\} \times 10^{-6}$ = 0.8×10^{-6} (kg·m²)</p> <p>I_A = $0.8 \times 10^{-6} + 0.006 \times 37^2 \times 10^{-6}$ = 9.0×10^{-6} (kg·m²)</p> <p>r₂ = 47(mm)</p> <p>m₂ = $5 \times 10 \times 12 \times 2.7 \times 10^{-6}$ = 0.002 (kg)</p> <p>I_{z2} = $\{0.002 \times (5^2 + 10^2)/12\} \times 10^{-6}$ = 0.02×10^{-6} (kg·m²)</p> <p>I_B = $0.02 \times 10^{-6} + 0.002 \times 47^2 \times 10^{-6}$ = 4.4×10^{-6} (kg·m²)</p> <p>I = $9.0 \times 10^{-6} + 4.4 \times 10^{-6}$ = $13.4 \times 10^{-6} = 0.13 \times 10^{-4}$ (kg·m²)</p>
3. Determine the allowable moment of inertia from the graph.	<p>MHY2-16D</p>	<p>The moment of inertia is determined to be 0.9×10^{-4} (kg·m²) according to the operating time (0.15 s) from the graph to the left.</p>
4. Confirm the moment of inertia of one attachment is within the allowable range.	<p>Moment of inertia of attachment < Allowable moment of inertia</p>	<p>0.13×10^{-4} (kg·m²) < 0.9×10^{-4} (kg·m²) Possible to use this model MHY2-16D completely.</p>

Symbol

Symbol	Definition	Unit
Z	Finger rotation axis	—
Z1	Axis on the center gravity of A part of attachment and parallel to Z	—
Z2	Axis on the center gravity of B part of attachment and parallel to Z	—
I	Total moment of inertia for attachment	kg·m ²
Iz1	Inertia moment around the Z1 axis of A part of attachment	kg·m ²
Iz2	Inertia moment around the Z2 axis of B part of attachment	kg·m ²

Symbol	Definition	Unit
IA	Moment of inertia around the Z axis of A part of attachment	kg·m ²
IB	Moment of inertia around the Z axis of B part of attachment	kg·m ²
m1	Weight of A part of attachment	kg
m2	Weight of B part of attachment	kg
r1	Distance between Z and Z1 axis	mm
r2	Distance between Z and Z2 axis	mm

Allowable Range of Moment of Inertia of Attachment

MHY2-10D

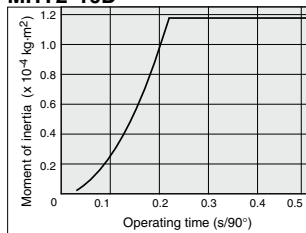

MHW2-20D

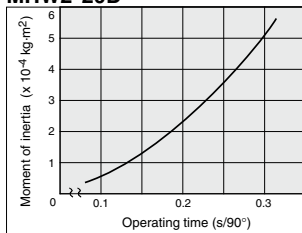

MHW2-50D

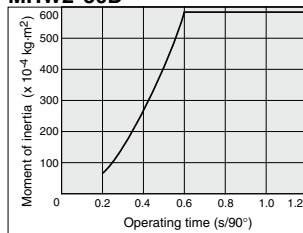

MHY2-16D

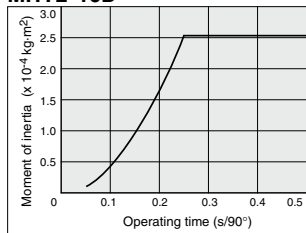

MHW2-25D

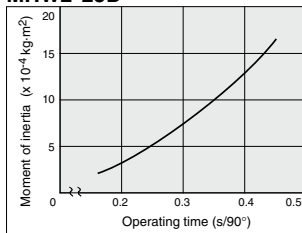

MHY2-20D

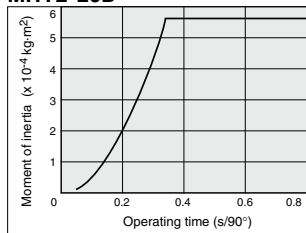

MHW2-32D

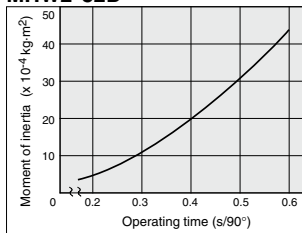

MHY2-25D

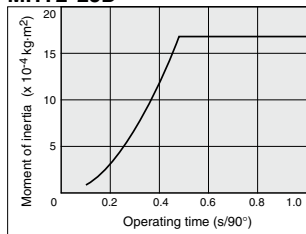

MHW2-40D

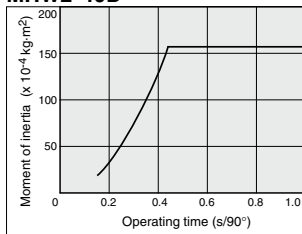

- MHZ
- MHF
- MHL
- MHR
- MHK
- MHS
- MHC
- MHT
- MHY**
- MHW
- X
- MRHQ
- MA
- D-

180° Angular Type Air Gripper Cam Type

MHY2 Series

∅10, ∅16, ∅20, ∅25

How to Order

MHY 2 - 16 D 2 - M9BW

Number of fingers

2	2 fingers
---	-----------

Bore size

10	10 mm
16	16 mm
20	20 mm
25	25 mm

Action

D	Double acting
---	---------------

Auto switch

Nil	Without auto switch (Built-in magnet)
-----	---------------------------------------

• **Made to Order**
Refer to page 705 for details.

• **Number of auto switches**

Nil	2 pcs.
S	1 pc.
n	n pc.

• **Finger option**

Nil: Standard tapped 2: Through-holes in opening/closing direction

Applicable Auto Switches / Refer to pages 797 to 850 for further information on auto switches.

Type	Special function	Electrical entry	Indicator light	Wiring (Output)	Load voltage		Auto switch model		Lead wire length (m)*				Pre-wired connector	Applicable load
					DC	AC	Electrical entry direction		0.5 (Nil)	1 (M)	3 (L)	5 (Z)		
							Perpendicular	In-line						
Solid state auto switch	—	Grommet	Yes	3-wire(NPN)	5 V, 12 V	—	M9NV	M9N	●	●	●	○	○	Relay, PLC
				3-wire(PNP)			M9PV	M9P	●	●	●	○	○	
				2-wire	M9BV	M9B	●	●	●	○	○	—		
				3-wire(NPN)	24 V	M9NWV	M9NW	●	●	●	○	○	IC circuit	
				3-wire(PNP)		M9PWV	M9PW	●	●	●	○	○	—	
				2-wire	M9B WV	M9B W	●	●	●	○	○	—		
	Water resistant (2-color indicator)	Grommet	Yes	3-wire(NPN)	5 V, 12 V	—	M9NAV**	M9NA**	○	○	●	○	○	IC circuit
				3-wire(PNP)			M9PAV**	M9PA**	○	○	●	○	○	—
				2-wire	M9BAV**	M9BA**	○	○	●	○	○	—		

** Water resistant type auto switches can be mounted on the above models, but in such case SMC cannot guarantee water resistance.

* Lead wire length symbols: 0.5 m Nil (Example) M9NW
 1 m M (Example) M9NWM
 3 m L (Example) M9NWL
 5 m Z (Example) M9NWZ

* Auto switches marked with a "○" symbol are produced upon receipt of order.

Note 1) When using the 2-color indicator type, please make the setting so that the indicator is lit in red to ensure the detection at the proper position of the air gripper.

Specifications

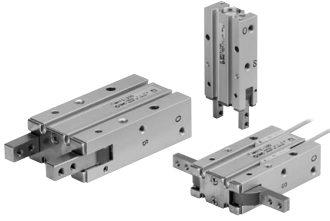

Fluid	Air
Operating pressure	0.1 to 0.6 MPa
Ambient and fluid temperature	-10 to 60°C
Repeatability	±0.2 mm
Max. operating frequency	60 c.p.m.
Lubrication	Not required
Action	Double acting
Auto switch (Option) ^{Note)}	Solid state auto switch (3-wire, 2-wire)

Note) Refer to pages 797 to 850 for further information on auto switches.

Symbol

Double acting: External grip

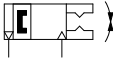

Model

Model	Bore size (mm)	Effective gripping force (1) (N·m)	Opening/Closing angle (Both sides)		Weight (2) (g)
			Opening side	Closing side	
MHY2-10D	10	0.16	180°	-3°	70
MHY2-16D	16	0.54			150
MHY2-20D	20	1.10			320
MHY2-25D	25	2.28			560

Note 1) At the pressure of 0.5 MPa

Note 2) Except auto switch

- Refer to "How to Select the Applicable Model" on page 700.
- Refer to pages 700 and 701 for the details on effective holding force and allowable overhanging distance.



Made to Order

(Refer to pages 725 to 748 for details.)

Symbol	Specifications/Description
-X4	Heat resistance (100°C)
-X5	Fluororubber seal
-X50	Without magnet
-X53	EPDM for seals, Fluorine grease
-X63	Fluorine grease
-X79	Grease for food processing machines, Fluorine grease
-X79A	Grease for food processing machines
-X81A	Anti-corrosive treatment of finger

Moisture Control Tube IDK Series



When operating an actuator with a small diameter and a short stroke at a high frequency, the dew condensation (water droplet) may occur inside the piping depending on the conditions.

Simply connecting the moisture control tube to the actuator will prevent dew condensation from occurring. For details, refer to [the IDK series in the Best Pneumatics No.6.](#)

MHZ

MHF

MHL

MHR

MHK

MHS

MHC

MHT

MHY

MHW

-X□

MRHQ

MA

D-□

MHY2 Series

Construction

Closed condition

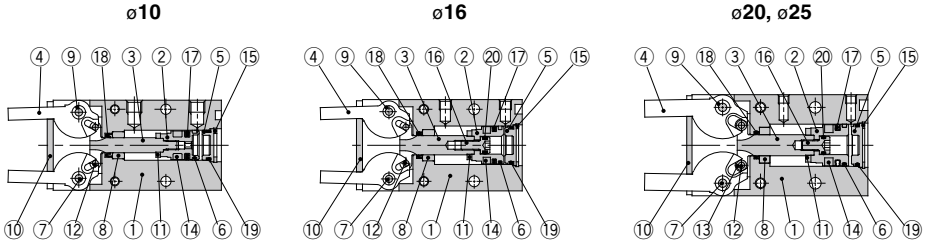

Open condition

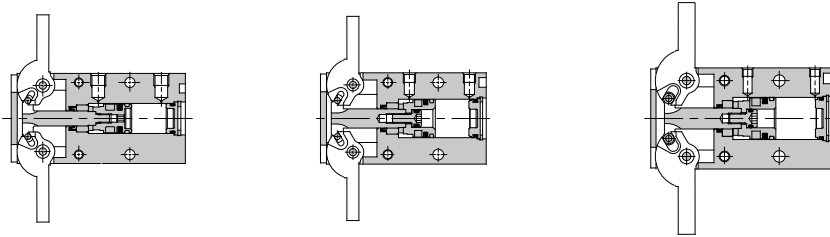

Component Parts

No.	Description	Material	Note
1	Body	Aluminum alloy	Hard anodized
2	Piston	ø10: Stainless steel ø16 to 25: Aluminum alloy	ø16 to 25: Chromated
3	Joint	Stainless steel	Heat treated
4	Finger	Stainless steel	Heat treated
5	Cap	Resin	
6	Wear ring	Resin	
7	Shaft	Stainless steel	Nitriding
8	Bushing A	Sintered alloy steel	
9	Bushing B	Sintered alloy steel	
10	End plate	Stainless steel	

No.	Description	Material	Note
11	Bumper	Urethane rubber	
12	Needle roller	High carbon chrome bearing steel	
13	Joint roller	Carbon steel	Nitriding
14	Rubber magnet	Synthetic rubber	
15	Type C retaining ring	Carbon steel	Phosphate coated
16	Piston bolt	Stainless steel	
17	Piston seal	NBR	
18	Rod seal	NBR	
19	Gasket	NBR	
20	Gasket	NBR	

Replacement Parts

Description		MHY2-10	MHY2-16	MHY2-20	MHY2-25	Main parts
Seal kit		MHY10-PS	MHY16-PS	MHY20-PS	MHY25-PS	<ø10> ①⑧⑨ <ø16, ø20, ø25> ①⑧⑨⑩
Finger assembly	MHY2-□D	MHY-A1001	MHY-A1601	MHY-A2001	MHY-A2501	④⑨
	MHY2-□D2	MHY-A1001-2	MHY-A1601-2	MHY-A2001-2	MHY-A2501-2	
Joint assembly		MHY-A1002	MHY-A1602	MHY-A2002	MHY-A2502	<ø10, ø16> ③⑫ <ø20, ø25> ③⑫⑬
Piston assembly		MHY-A1003	MHY-A1603	MHY-A2003	MHY-A2503	<ø10> ②⑥⑪⑭ <ø16, ø20, ø25> ②⑥⑪⑫⑬⑯

* Order 1 piece of finger assembly per one unit.

Replacement part/grease pack part no. : MH-G04 (30 g)

Dimensions

MHY2-10D

Pin hole positioning

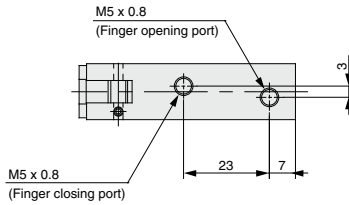
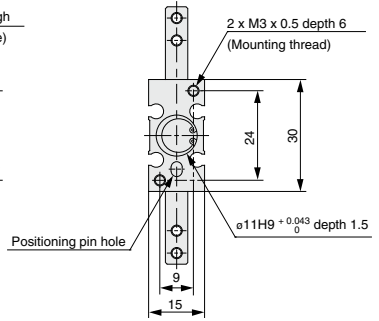
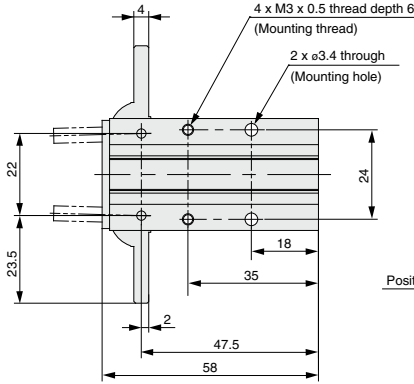
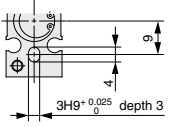
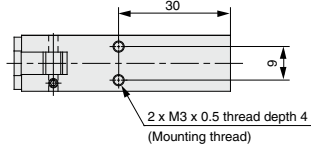
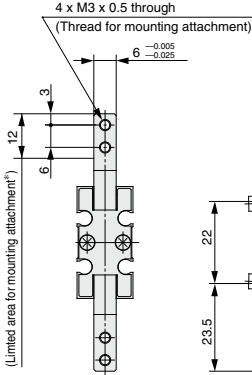

Auto Switch Mounting Groove Dimensions

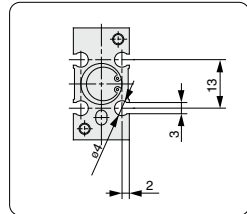

MHY2-10D2

Opening/Closing direction through-hole type

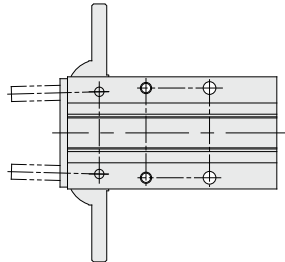
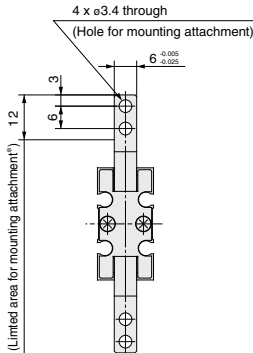

* Do not extend the attachment from limited area for mounting to avoid interference with the attachment or main body.

- MHZ
- MHF
- MHL
- MHR
- MHK
- MHS
- MHC
- MHT
- MHY**
- MHW
- X□
- MRHQ
- MA
- D-□

MHY2 Series

Dimensions

MHY2-16D

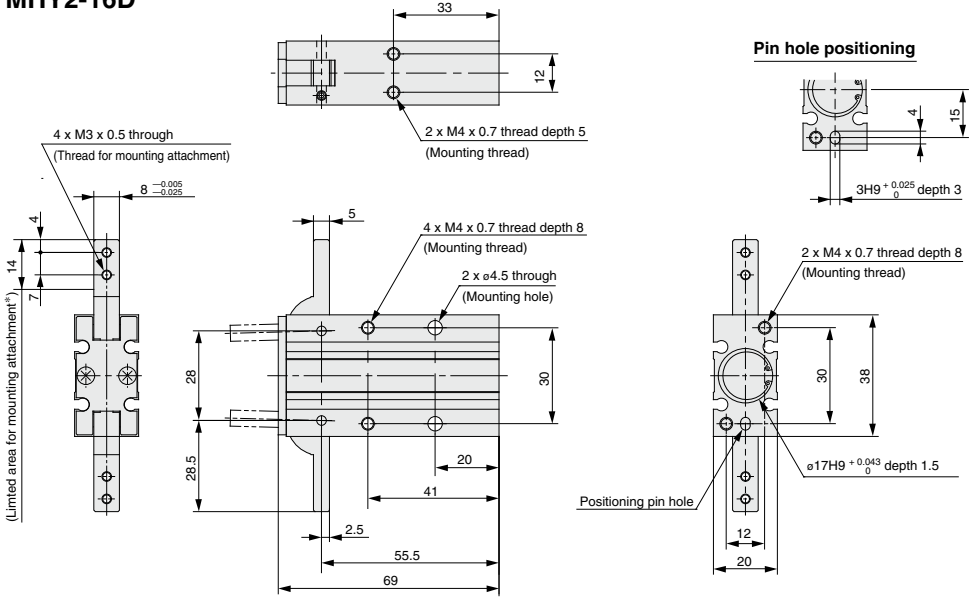

Auto Switch Mounting Groove Dimensions

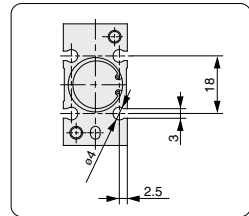

MHY2-16D2 Opening/Closing direction through-hole type

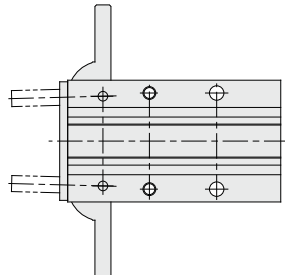
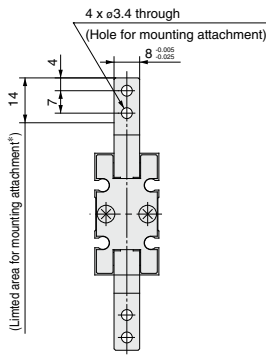

* Do not extend the attachment from limited area for mounting to avoid interference with the attachment or main body.

MHY2-20D

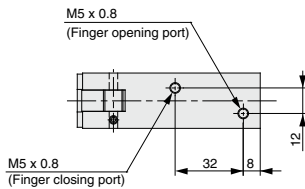
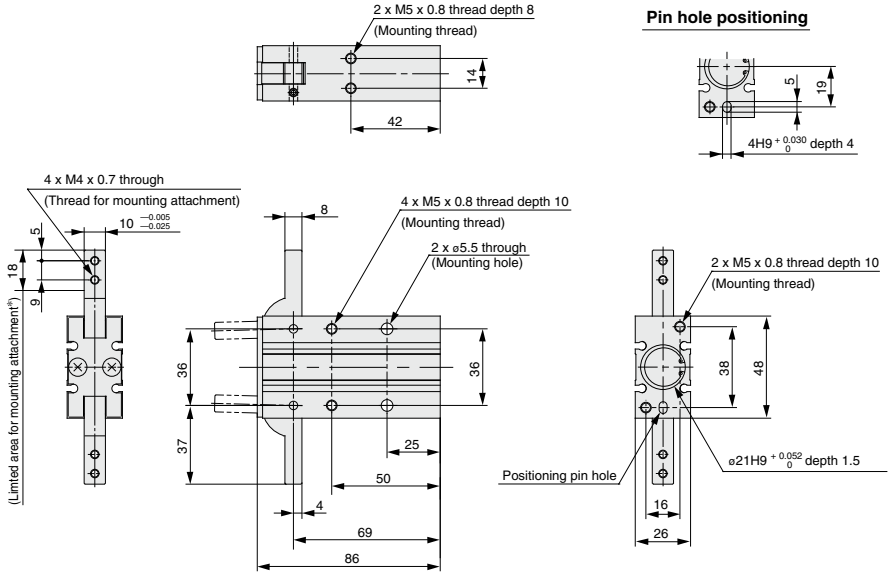

Auto Switch Mounting Groove Dimensions

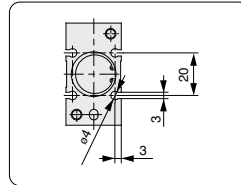

MHY2-20D2

Opening/Closing direction through-hole type

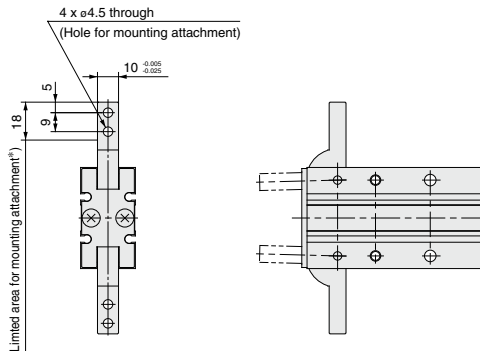

* Do not extend the attachment from limited area for mounting to avoid interference with the attachment or main body.

MHZ
MHF
MHL
MHR
MHK
MHS
MHC
MHT
MHY
MHW
-X□
MRHQ
MA
D-□

MHY2 Series

Dimensions

MHY2-25D

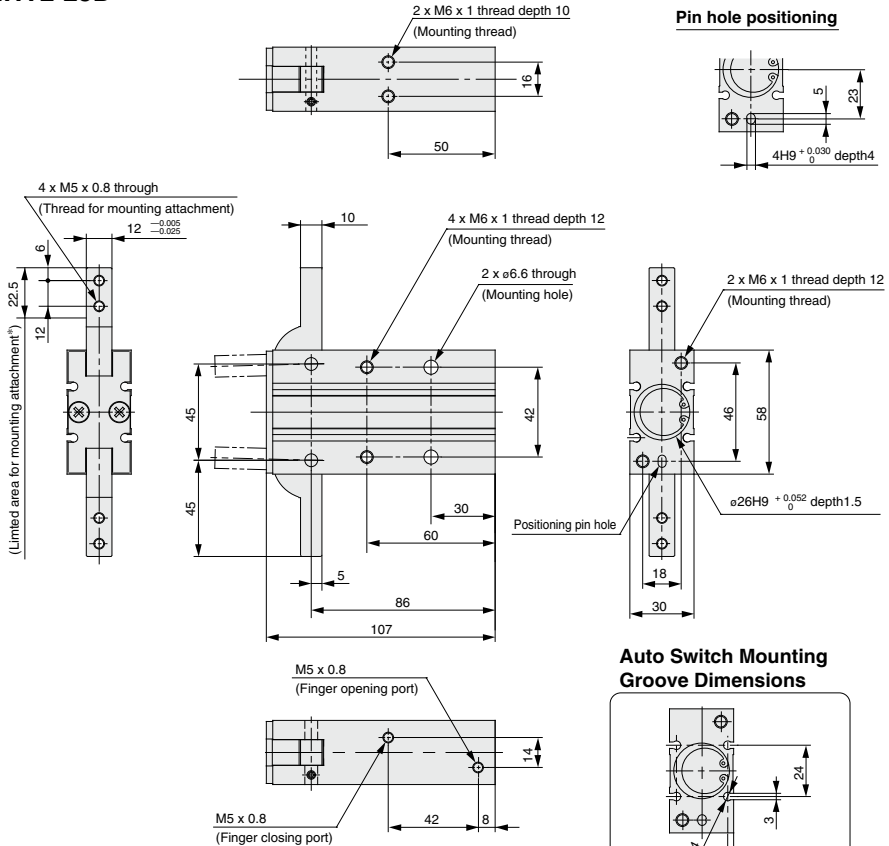

MHY2-25D2 Opening/Closing direction through-hole type

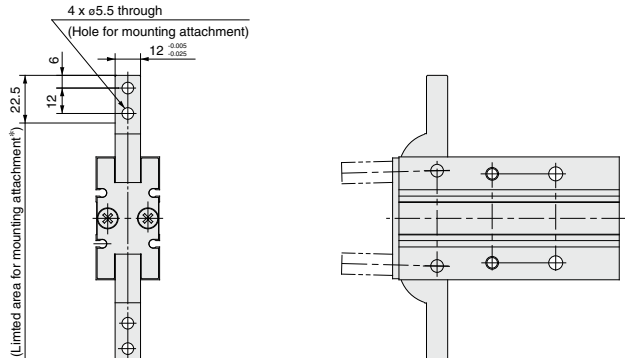

* Do not extend the attachment from limited area for mounting to avoid interference with the attachment or main body.