

# Metal One-touch Fittings

## KQB2 Series

### Compact and Light

Dimensions **Approx. 30%** **Shorter**  
\* Comparison with KQBL06-01S

Weight **Approx. 62%** **Lighter**  
\* Comparison with KQBL06-01S

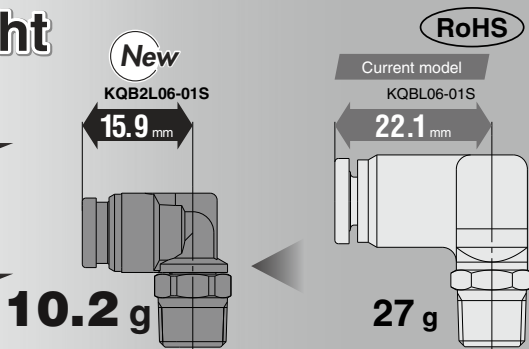

Fluid temperature **-5 to 150°C**

Connection thread **M, R, Rc, UNF, NPT, G**

Applicable tubing material **FEP • PFA • Nylon • Soft nylon  
Polyurethane • Polyolefin**

Electroless nickel plated  
(Brass parts)

Grease-free

KQ2

**KQB2**

KS  
KX

KM

KF

M

H/DL  
L/LL

KC

KK

KK130

DM

KDM

KB

KR

KA

KQG2

KG

KFG2

MS

KKA

KP

LQ

MQR

T

IDK

### Variations

	Applicable tubing O.D. (mm)						
	ø3.2	ø4	ø6	ø8	ø10	ø12	ø16
M5	●	●	●				
R1/8	●	●	●	●	●		
G1/8	●	●	●	●	●		
R1/4	●	●	●	●	●	●	
G1/4		●	●	●	●	●	
R3/8			●	●	●	●	●
G3/8			●	●	●	●	●
R1/2				●	●	●	●
G1/2				●	●	●	●
No thread	●	●	●	●	●	●	●

	Applicable tubing O.D. (inch)					
	ø1/8"	ø5/32"	ø1/4"	ø5/16"	ø3/8"	ø1/2"
10-32 UNF	●	●	●			
NPT1/8	●	●	●	●	●	
NPT1/4	●	●	●	●	●	●
NPT3/8		●	●	●	●	●
NPT1/2			●	●	●	●
No thread	●	●	●	●	●	●

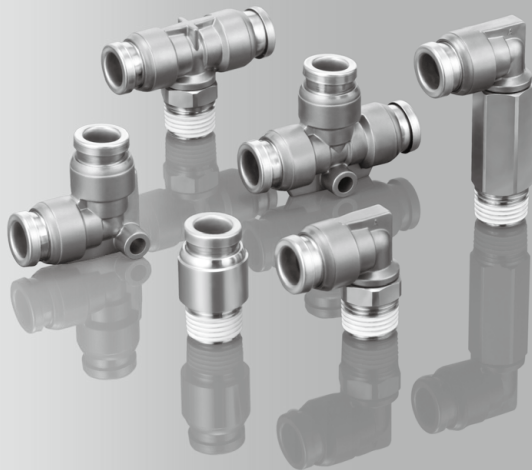

## Compact and light

Dimensions: Approx. **30%** shorter

\* Comparison with KQBL06-01S

Weight: Approx. **62%** lighter

\* Comparison with KQBL06-01S

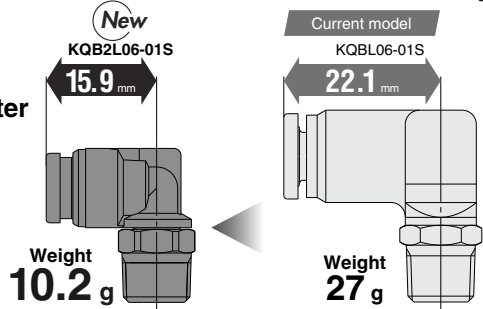

○ Inch size x UNF/NPT thread,  
Metric size x G thread

○ Applicable tubing size

∅3.2 to ∅16, ∅1/8" to ∅1/2"

○ Connection thread: M, R, Rc, UNF, NPT, G

○ Fluid temperature: **-5 to 150°C**

○ Grease-free

○ Applicable tubing material

FEP • PFA • Nylon • Soft nylon  
Polyurethane • Polyolefin

○ Electroless nickel plated  
(Brass parts)

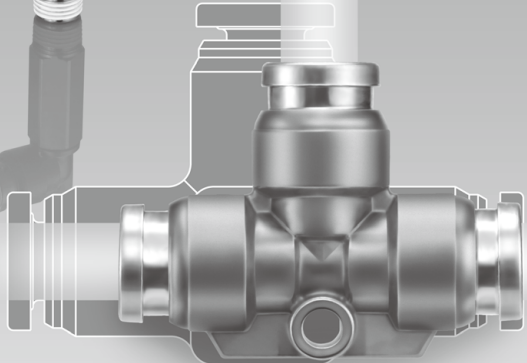
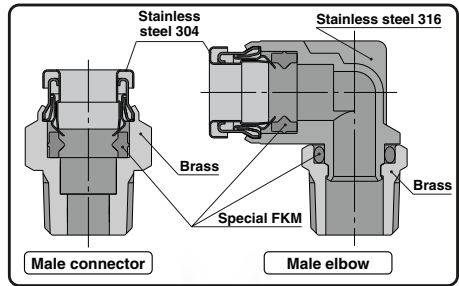

## Variations

### Male Connector **KQB2H**



Metric  
R thread ...P. 143  
G thread ... P. 156  
Inch ..... P. 150

### Hexagon Socket Head Male Connector **KQB2S**



Metric  
R thread ...P. 143  
G thread ...P. 156  
Inch ..... P. 150

### Straight Union **KQB2H**



Metric ...P. 143  
Inch ..... P. 150

### Male Elbow **KQB2L**



Metric  
R thread ...P. 144  
G thread ...P. 157  
Inch ..... P. 151

### Male Branch Tee **KQB2T**



Metric  
R thread ...P. 144  
G thread ...P. 157  
Inch ..... P. 151

### Union Elbow **KQB2L**



Metric ...P. 145  
Inch ..... P. 151

### Bulkhead Union **KQB2E**



Metric ...P. 145  
Inch ..... P. 152

### Union Tee **KQB2T**



Metric ...P. 145  
Inch ..... P. 152

### Union "Y" **KQB2U**



Metric ...P. 145  
Inch ..... P. 152

### Different Diameter Tee **KQB2T**



Metric ...P. 146  
Inch ..... P. 152

### Plug-in Reducer **KQB2R**



Metric ...P. 146  
Inch ..... P. 152

### Different Diameter Straight **KQB2H**



Metric ...P. 146  
Inch ..... P. 153

### Different Diameter Union "Y" **KQB2U**



Metric ...P. 146  
Inch ..... P. 153

### Bulkhead Connector **KQB2E**



Metric  
Rc thread ... P. 147  
G thread ... P. 158  
Inch ..... P. 153

### Extended Male Elbow **KQB2W**



Metric  
R thread ... P. 147  
G thread ... P. 158  
Inch ..... P. 153

### Female Connector **KQB2F**



Metric  
Rc thread ... P. 148  
G thread ... P. 158  
Inch ..... P. 154

### Plug **KQB2P**



Metric ...P. 148  
Inch ..... P. 154

**KQ2**

**KQB2**

**KS  
KX**

**KM**

**KF**

**M**

**H/DL  
L/LL**

**KC**

**KK**

**KK130**

**DM**

**KDM**

**KB**

**KR**

**KA**

**KQG2**

**KG**

**KFG2**

**MS**

**KKA**

**KP**

**LQ**

**MQR**

**T**

**IDK**

# Metal One-touch Fittings

Applicable Tubing: Metric Size, Connection Thread: M, R, Rc

# KQB2 Series

RoHS



## Applicable Tubing

Tubing material	FEP, PFA, Nylon, Soft nylon, Polyurethane, Polyolefin
Tubing O.D.	ø3.2, ø4, ø6, ø8, ø10, ø12, ø16

## Specifications

<b>Fluid</b>	Air, Water <sup>Note 2)</sup>
<b>Operating pressure range</b> <sup>Note 1)</sup>	-100 kPa to 1 MPa <sup>Note 3)</sup>
<b>Proof pressure</b>	3.0 MPa
<b>Ambient and fluid temperature</b> <sup>Note 4)</sup>	-5 to 150°C (No freezing) <sup>Note 3)</sup>
<b>Lubricant</b>	Grease-free specification
<b>Seal on the threads</b>	With sealant

- Note 1) Avoid using in a vacuum holding application such as a leak tester, since there is leakage.  
 Note 2) Deionized water is not recommended for use as it may affect the material used in the fittings. In addition, it is known to degrade the water quality.  
 Note 3) Check the operating pressure range and operating temperature range of the tubing.  
 Note 4) It is recommended that you use the inner sleeve in the following conditions (Except ø3.2):
- When using in an environment where the fluid temperature changes drastically.
  - When using at a high temperature.

### \* Temperature Condition of Mounting the Inner Sleeve

Tubing	Temperature
FEP tubing/TH Series	80°C or more
Super PFA tubing/TL Series	120°C or more

## Spare Parts

Description	Tubing O.D.	Part no.	Material
Gasket	—	<b>M-5G3</b>	Stainless steel 316, Special FKM
Bulkhead nut	ø3.2	<b>KQB223-P01</b>	C3604 (Electroless nickel plated)
	ø4		
	ø6		
	ø8		
	ø10		
	ø12	<b>KQB212-P01</b>	
	ø16	<b>KQB216-P01</b>	

## Cross Reference Table of the Inner Sleeve

Tubing O.D.	Tubing material			Applicable inner sleeve	
	TUS (Soft polyurethane)	TH/THI (FEP)	TL/TIL (Super PFA)	Part no.	Length
ø4	—	TH0402	—	<b>TJ-0402</b>	18
	TUS0425	TH0425	—	<b>TJ-0425</b>	18
	—	—	TL0403	<b>TJ-0403</b>	18
ø6	TUS0604	TH0604	TL0604	<b>TJ-0604</b>	19
	TUS0805	—	—	<b>TJ-0805</b>	20.5
ø8	—	TH0806	TL0806	<b>TJ-0806</b>	20.5
	TUS1065	—	—	<b>TJ-1065</b>	23
ø10	—	TH1075	—	<b>TJ-1075</b>	23
	—	TH1008	TL1008	<b>TJ-1008</b>	24
	TUS1208	—	—	<b>TJ-1208</b>	24
ø12	—	TH1209	—	<b>TJ-1209</b>	24
	—	TH1210	TL1210	<b>TJ-1210</b>	24
	—	—	—	—	—

\* C2700 + Electroless nickel plated is used for the TJ series.

## Construction

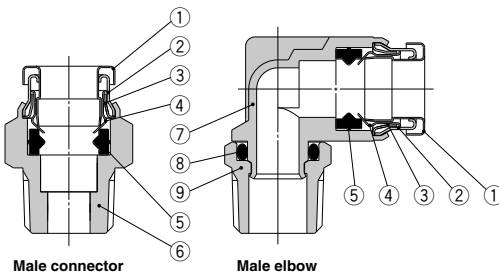

## Component Parts

No.	Description	Material
1	Release button	Stainless steel 304
2	Guide 1	Stainless steel 304
3	Guide 2	Stainless steel 304
4	Chuck	Stainless steel 304
5	Seal	Special FKM (Fluoro coated)
6	Male connector body	C3604 (Electroless nickel plated)
7	Male elbow body	Stainless steel 316
8	O-ring	Special FKM (Fluoro coated)
9	Stud	C3604 (Electroless nickel plated)

## Dimensions

### Male Connector: KQB2H



Applicable tubing O.D. (mm)	Connection thread R, M	Model	H (Width across flat)	Note 1) $\phi D$	L	A*	M	Note 2) Effective area (mm <sup>2</sup> )	Weight (g)
$\phi 3.2$	M5 x 0.8	KQB2H23-M5	8	8	16.5	13.5	12	3	3.4
	1/8	KQB2H23-01S	10		15.4	12.3		3.4	6
	1/4	KQB2H23-02S	14		21	16.3		17.8	
$\phi 4$	M5 x 0.8	KQB2H04-M5	10	8.7	17.1	14.1	12.6	4	5.3
	1/8	KQB2H04-01S	14		15.3	12.2		5.6	5.6
	1/4	KQB2H04-02S	14		20.9	16.2		17.2	
$\phi 6$	M5 x 0.8	KQB2H06-M5	12	11.1	19.1	16.1	13.6	4	8
	1/8	KQB2H06-01S	14		18.1	15		7.3	7.3
	1/4	KQB2H06-02S	14		20.8	16.1		13.1	15.2
	3/8	KQB2H06-03S	17		23	17.9		28.8	
$\phi 8$	1/8	KQB2H08-01S	14	13.4	24.5	21.4	16.1	26.1	13.5
	1/4	KQB2H08-02S	17		22.3	17.6		26	26
	3/8	KQB2H08-03S	17		23.7	18.6		19.8	
$\phi 10$	1/8	KQB2H10-01S	14	16.4	25.5	22.4	17	26.1	19.8
	1/4	KQB2H10-02S	17		27.9	23.2		41.5	22.7
	3/8	KQB2H10-03S	17		23	17.9		21.6	21.6
	1/2	KQB2H10-04S	22		28.6	22.2		53.9	53.9
$\phi 12$	1/4	KQB2H12-02S	19	18.5	30.5	25.8	18.6	58.3	28.8
	3/8	KQB2H12-03S	22		24.7	19.6		21.5	21.5
	1/2	KQB2H12-04S	22		28.7	22.3		47	47
$\phi 16$	3/8	KQB2H16-03S	24	24.6	33.6	28.5	20.8	81	48.3
	1/2	KQB2H16-04S	24		29.5	23.1		113	39.2

\* Reference dimensions after installation of R thread  
 Note 1)  $\phi D$  is maximum diameter.  
 Note 2) Value of FEP tubing.  
 Value of nylon tubing for  $\phi 16$  only.

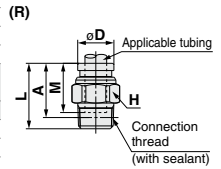
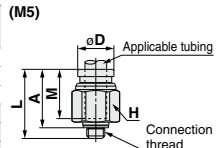

### Hexagon Socket Head Male Connector: KQB2S



Applicable tubing O.D. (mm)	Connection thread R, M	Model	H (Width across flat)	Note 1) $\phi D$	L	A*	M	Note 2) Effective area (mm <sup>2</sup> )	Weight (g)
$\phi 3.2$	M5 x 0.8	KQB2S23-M5	2	9	16.5	13.5	12	3	4
$\phi 4$	M5 x 0.8	KQB2S04-M5	2	9	17.1	14.1	12.6	4	3.9
	1/8	KQB2S04-01S	3	10	20.4	17.3		4.1	7.9
$\phi 6$	M5 x 0.8	KQB2S06-M5	2	12	19.6	16.6	13.6	4	7.8
	1/8	KQB2S06-01S	4		20.6	17.5		10	9.1
	1/4	KQB2S06-02S	4		14	20.6		15.9	10.7
$\phi 8$	1/8	KQB2S08-01S	5	14	24.7	21.6	16.1	17.2	13
	1/4	KQB2S08-02S	6		22.9	18.2		23.3	13.5
	3/8	KQB2S08-03S	6		17	23.1		18	24
$\phi 10$	1/8	KQB2S10-01S	5	17	25.6	22.5	17	17.2	18.6
	1/4	KQB2S10-02S	8		27.5	22.8		20	20
	3/8	KQB2S10-03S	8		24	18.9		39	22
	1/2	KQB2S10-04S	8		22	17.6		39.2	39.2
$\phi 12$	1/4	KQB2S12-02S	8	19	30.6	25.9	18.6	46	26
	3/8	KQB2S12-03S	10		24.9	19.8		60	20.2
	1/2	KQB2S12-04S	10		22	18.5		35.3	35.3
$\phi 16$	3/8	KQB2S16-03S	10	24.6	33.2	28.1	20.8	81	43.6
	1/2	KQB2S16-04S	12		29.4	23		113	40.3

\* Reference dimensions after installation of R thread  
 Note 1)  $\phi D$  is maximum diameter.  
 Note 2) Value of FEP tubing.  
 Value of nylon tubing for  $\phi 16$  only.

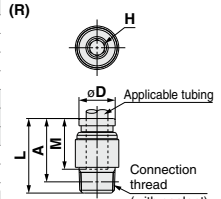
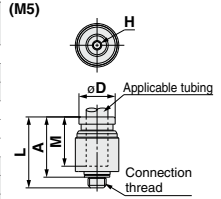

### Straight Union: KQB2H



Applicable tubing O.D. (mm)	Model	$\phi D$ Note 1)	L	M	Note 2) Effective area (mm <sup>2</sup> )	Weight (g)
$\phi 3.2$	KQB2H23-00	9	25	12	3.4	6.8
$\phi 4$	KQB2H04-00	9	26.2	12.6	5.6	6.8
$\phi 6$	KQB2H06-00	12	28.2	13.6	13.1	12
$\phi 8$	KQB2H08-00	14	33.2	16.1	26.1	17.4
$\phi 10$	KQB2H10-00	17	35	17	41.5	27.2
$\phi 12$	KQB2H12-00	19	38.2	18.6	58.3	33.7
$\phi 16$	KQB2H16-00	24.6	42.6	20.8	113	56.1

Note 1)  $\phi D$  is maximum diameter.  
 Note 2) Value of FEP tubing.  
 Value of nylon tubing for  $\phi 16$  only.

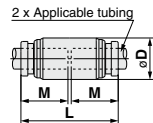

- KQ2
- KQB2
- KS
- KX
- KM
- KF
- M
- H/DL
- L/LL
- KC
- KK
- KK130
- DM
- KDM
- KB
- KR
- KA
- KQG2
- KG
- KFG2
- MS
- KKA
- KP
- LQ
- MQR
- T
- IDK

# KQB2 Series

Applicable Tubing: Metric Size, Connection Thread: M, R, Rc

## Dimensions

### Male Elbow: KQB2L



Applicable tubing O.D. (mm)	Connection Thread R, M	Model	H (Width across flat)	Note 1) $\phi D$	L1	L2	A*	M	Note 2) Effective area (mm <sup>2</sup> )	Weight (g)
$\phi 3.2$	M5 x 0.8	KQB2L23-M5	8	8.3	13.1	14.8	16	12	2.6	6.5
	1/8	KQB2L23-01S	10		13.6	14.9	15.9			8
	1/4	KQB2L23-02S	14		13.7	15.2	16.8			16.6
$\phi 4$	M5 x 0.8	KQB2L04-M5	8	9.1	13.7	15.2	16.8	12.6	3.5	7
	1/8	KQB2L04-01S	10		14.4	15.3	16.7			8.6
	1/4	KQB2L04-02S	14		14.7	16.3	19			17.5
$\phi 6$	M5 x 0.8	KQB2L06-M5	8	11.4	14.7	16.3	19	13.6	11.4	9
	1/8	KQB2L06-01S	10		15.9	16.4	21.2			10.2
	1/4	KQB2L06-02S	14		15.9	20.2	24.6			19.1
$\phi 8$	3/8	KQB2L06-03S	17	13.7	15.9	21.6	22.2	16.1	21.6	31.2
	1/8	KQB2L08-01S	12		18.6	18.3	22			14.8
	1/4	KQB2L08-02S	14		19.1	21.5	23.6			20.8
$\phi 10$	3/8	KQB2L08-03S	17	16.6	19.1	22.9	24.6	17	21.6	32.8
	1/8	KQB2L10-01S	12		20	19.7	24.9			20.4
	1/4	KQB2L10-02S	14		21	22.9	26.5			23.7
$\phi 12$	3/8	KQB2L10-03S	17	18.7	21	24.3	27.5	18.6	35.2	34.5
	1/2	KQB2L10-04S	22		21	28.5	30.4			62.6
	1/4	KQB2L12-02S	14		22.6	24	28.6			27.4
$\phi 16$	3/8	KQB2L12-03S	17	24.6	23.6	25.3	29.5	20.8	50.2	34.3
	1/2	KQB2L12-04S	22		23.6	29.5	32.4			60.8
	3/8	KQB2L16-03S	19		26.3	28	34.5			71
	1/2	KQB2L16-04S	22		27.3	31.8	37		100	62.6

\* Reference dimensions after installation of R thread

Note 1)  $\phi D$  is maximum diameter.

Note 2) Value of FEP tubing.

Value of nylon tubing for  $\phi 16$  only.

(M5)

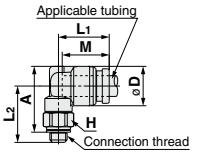

(R)

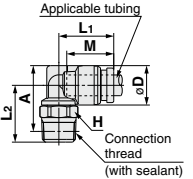

### Male Branch Tee: KQB2T



Applicable tubing O.D. (mm)	Connection Thread R, M	Model	H (Width across flat)	Note 1) $\phi D$	L1	L2	A*	M	Note 2) Effective area (mm <sup>2</sup> )	Weight (g)
$\phi 3.2$	M5 x 0.8	KQB2T23-M5	8	8.3	13.1	14.8	16	12	3.2	8.2
	1/8	KQB2T23-01S	10		13.6	14.9	15.9			9.6
	1/4	KQB2T23-02S	14		13.7	15.2	16.8			18.4
$\phi 4$	M5 x 0.8	KQB2T04-M5	8	9.1	13.7	15.2	16.8	12.6	4.5	9.1
	1/8	KQB2T04-01S	10		14.4	15.3	16.7			10.6
	1/4	KQB2T04-02S	14		14.7	16.3	19			19.4
$\phi 6$	M5 x 0.8	KQB2T06-M5	8	11.4	14.7	16.3	19	13.6	4.5	12.1
	1/8	KQB2T06-01S	10		15.9	16.4	21.2			13.6
	1/4	KQB2T06-02S	14		15.9	20.2	24.6			22.5
$\phi 8$	3/8	KQB2T06-03S	17	13.7	15.9	21.6	22.2	16.1	26.3	35
	1/8	KQB2T08-01S	12		18.6	18.3	22			20
	1/4	KQB2T08-02S	14		19.1	21.5	23.6			26.1
$\phi 10$	3/8	KQB2T08-03S	17	16.6	19.1	22.9	24.6	17	40.8	38
	1/8	KQB2T10-01S	12		20	19.7	24.9			28.6
	1/4	KQB2T10-02S	14		21	22.9	26.5			31.5
$\phi 12$	3/8	KQB2T10-03S	17	18.7	21	24.3	27.5	18.6	57.2	42.4
	1/2	KQB2T10-04S	22		21	28.5	30.4			70.4
	1/4	KQB2T12-02S	14		22.6	24	28.6			38.1
$\phi 16$	3/8	KQB2T12-03S	17	24.6	23.6	25.3	29.5	20.8	100	39.7
	1/2	KQB2T12-04S	22		23.6	29.5	32.4			70.8
	3/8	KQB2T16-03S	19		26.3	28	34.5			71
	1/2	KQB2T16-04S	22		27.3	31.8	37		100	79

\* Reference dimensions after installation of R thread

Note 1)  $\phi D$  is maximum diameter.

Note 2) Value of FEP tubing.

Value of nylon tubing for  $\phi 16$  only.

(M5)

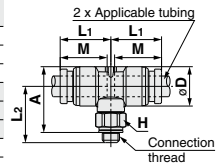

(R)

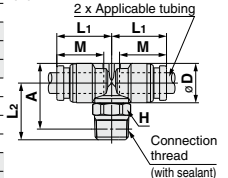

# Metal One-touch Fittings **KQB2 Series**

Applicable Tubing: Metric Size, Connection Thread: M, R, Rc

## Dimensions

### Union Elbow: KQB2L



Applicable tubing O.D. (mm)	Model	Note 1) $\phi D$	L	A	Q	M	$\phi N$	$\phi O$	Note 2) Effective area (mm <sup>2</sup> )	Weight (g)
$\phi 3.2$	KQB2L23-00	8.3	13.6	19.3	2.9	12	3.2	5.6	3	6.3
$\phi 4$	KQB2L04-00	9.1	14.6	20.5	3.1	12.6	3.2	5.6	4.2	7.4
$\phi 6$	KQB2L06-00	11.4	16.6	23	3.6	13.6	3.2	5.6	11.4	11
$\phi 8$	KQB2L08-00	13.7	20.1	29.1	5	16.1	4.2	8	21.6	20.2
$\phi 10$	KQB2L10-00	16.6	22	31.7	5.7	17	4.2	8	35.2	29.6
$\phi 12$	KQB2L12-00	18.7	24.6	35	6.4	18.6	4.2	8	50.2	37.1
$\phi 16$	KQB2L16-00	24.6	28.8	40.5	7.7	20.8	4.2	8	100	59.7

Note 1)  $\phi D$  is maximum diameter.

Note 2) Value of FEP tubing.

Value of nylon tubing for  $\phi 16$  only.

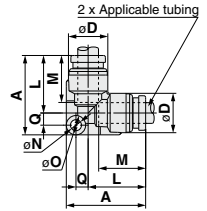

### Bulkhead Union: KQB2E



Applicable tubing O.D. (mm)	Model	T (M)	H (Width across flat)	L	Mounting hole	M	Note) Effective area (mm <sup>2</sup> )	Weight (g)
$\phi 3.2$	KQB2E23-00	M10 x 1	12	32.2	11	12	3.4	14.8
$\phi 4$	KQB2E04-00	M10 x 1	12	32.4	11	12.6	5.6	14.7
$\phi 6$	KQB2E06-00	M14 x 1	17	35.4	15	13.6	13.1	29.2
$\phi 8$	KQB2E08-00	M15 x 1	19	38.8	16	16.1	26.1	34.9
$\phi 10$	KQB2E10-00	M18 x 1	21	40	19	17	41.5	47.1
$\phi 12$	KQB2E12-00	M20 x 1	24	42.4	21	18.6	58.3	58.7
$\phi 16$	KQB2E16-00	M27 x 1	30	46.8	28	20.8	113	107.2

Note) Value of FEP tubing.

Value of nylon tubing for  $\phi 16$  only.

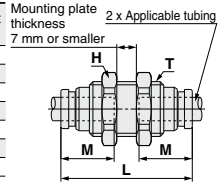

### Union Tee: KQB2T



Applicable tubing O.D. (mm)	Model	Note 1) $\phi D$	L	A	Q	M	$\phi N$	$\phi O$	Note 2) Effective area (mm <sup>2</sup> )	Weight (g)
$\phi 3.2$	KQB2T23-00	8.3	13.6	20.5	4.1	12	3.2	5.6	3.4	7.9
$\phi 4$	KQB2T04-00	9.1	14.6	21.8	4.4	12.6	3.2	5.6	6.4	9.5
$\phi 6$	KQB2T06-00	11.4	16.6	24.6	5.2	13.6	3.2	5.6	13.4	14.2
$\phi 8$	KQB2T08-00	13.7	20.1	31.1	7	16.1	4.2	8	25.6	24.4
$\phi 10$	KQB2T10-00	16.6	22	34	8	17	4.2	8	40	36.8
$\phi 12$	KQB2T12-00	18.7	24.6	37.7	9.1	18.6	4.2	8	57.4	47
$\phi 16$	KQB2T16-00	24.6	28.8	43.4	10.6	20.8	4.2	8	100	75.5

Note 1)  $\phi D$  is maximum diameter.

Note 2) Value of FEP tubing.

Value of nylon tubing for  $\phi 16$  only.

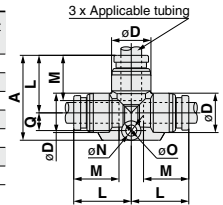

### Union "Y": KQB2U



Applicable tubing O.D. (mm)	Model	Note 1) $\phi D$	W	L1	L2	P	M	$\phi N$	$\phi O$	Note 2) Effective area (mm <sup>2</sup> )	Weight (g)
$\phi 3.2$	KQB2U23-00	8.3	16.4	29	11	8.1	12	3.2	5.6	3.4	9.2
$\phi 4$	KQB2U04-00	9.1	18.2	30.4	11.3	9.1	12.6	3.2	5.6	4.2	11.1
$\phi 6$	KQB2U06-00	11.4	22.9	34.9	12.2	11.5	13.6	3.2	5.6	13.4	18.8
$\phi 8$	KQB2U08-00	13.7	28.3	40.1	14.1	14.6	16.1	4.2	8	25.6	29.7
$\phi 10$	KQB2U10-00	16.6	34.2	44	14.4	17.6	17	4.2	8	40	47.4
$\phi 12$	KQB2U12-00	18.7	38.5	48.4	15.8	19.8	18.6	4.2	8	57.4	62.1
$\phi 16$	KQB2U16-00	24.6	49.3	56.6	17.3	26	20.8	4.2	8	113	110.2

Note 1)  $\phi D$  is maximum diameter.

Note 2) Value of FEP tubing.

Value of nylon tubing for  $\phi 16$  only.

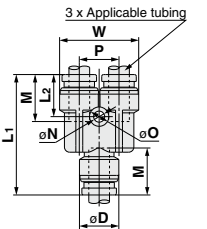

KQ2

KQB2

KS

KX

KM

KF

M

H/DL

L/LL

KC

KK

KK130

DM

KDM

KB

KR

KA

KQG2

KG

KFG2

MS

KKA

KP

LQ

MQR

T

IDK

# KQB2 Series

Applicable Tubing: Metric Size, Connection Thread: M, R, Rc

## Dimensions

### Different Diameter Tee: KQB2T



Applicable tubing O.D. (mm)		Model	Note 1)		L1	L2	L3	Q	M1	M2	øN	øO	Note 2) Effective area (mm <sup>2</sup> )	Weight (g)
a	b		øD1	øD2										
ø3.2	ø4	KQB2T23-04	9.1	8.3	14.2	14.1	21.1	4.1	12.6	12	3.2	5.6	3.8	8.5
ø4	ø6	KQB2T04-06	11.4	9.1	15.6	15.7	22.8	4.4	13.6	12.6	3.2	5.6	7.1	11
ø6	ø8	KQB2T06-08	13.7	11.4	19.1	17.7	29.5	6.4	16.1	13.6	4.2	8	16.4	20
ø8	ø10	KQB2T08-10	16.6	13.7	21	21.2	32.1	7.1	17	16.1	4.2	8	36	29.8
ø10	ø12	KQB2T10-12	18.7	16.6	23.6	23.1	35.7	8.1	18.6	17	4.2	8	56	41.3
ø12	ø16	KQB2T12-16	24.6	18.7	26.8	26.7	39.9	9.1	20.8	18.6	4.2	8	108.5	58

Note 1) øD1, øD2 are maximum diameters.  
Note 2) Value of FEP tubing.

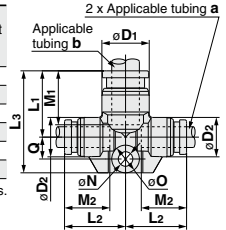

### Plug-in Reducer: KQB2R



Applicable tubing O.D. (mm)	Applicable fitting size ød	Model	Note 1)	L	A	M	Note 2)	Weight (g)
ø3.2	ø4		øD				Effective area (mm <sup>2</sup> )	
ø3.2	ø4	KQB2R23-04	9	32.9	20.3	12	3.4	4.9
ø4	ø6	KQB2R04-06	9	34.4	20.8	12.6	5.6	7
ø6	ø8	KQB2R06-08	12	38.4	22.3	13.6	13.1	12.7
ø8	ø10	KQB2R08-10	14	41.9	24.9	16.1	26.1	19.2
ø10	ø12	KQB2R10-12	17	44.8	26.2	17	41.5	27.8
ø12	ø16	KQB2R12-16	19	42.9	22.1	18.6	58.3	37.2

Note 1) øD is maximum diameter.  
Note 2) Value of FEP tubing.

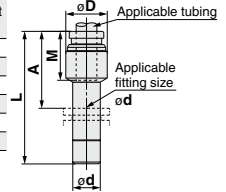

### Different Diameter Straight: KQB2H



Applicable tubing O.D. (mm)		Model	øD Note 1)	L	M1	M2	Note 2)	Weight (g)
a	b						Effective area (mm <sup>2</sup> )	
ø3.2	ø4	KQB2H23-04	9	25.6	12	12.6	3.4	6.8
ø4	ø6	KQB2H04-06	12	27.2	12.6	13.6	5.6	12.1
ø6	ø8	KQB2H06-08	14	30.7	13.6	16.1	13.1	17.1
ø8	ø10	KQB2H08-10	17	34.1	16.1	17	26.1	27.2
ø10	ø12	KQB2H10-12	19	36.6	17	18.6	41.5	34.8
ø12	ø16	KQB2H12-16	24.6	40.4	18.6	20.8	58.3	57.3

Note 1) øD is maximum diameter.  
Note 2) Value of FEP tubing.

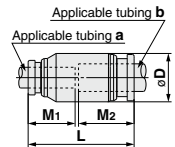

### Different Diameter Union "Y": KQB2U



Applicable tubing O.D. (mm)		Model	Note 1)	L1	L2	P	W	M1	M2	øN	øO	Note 2)	Weight (g)
a	b		øD									Effective area (mm <sup>2</sup> )	
ø3.2	ø4	KQB2U23-04	9.1	27	10.8	8.1	16.4	12	12.6	3.2	5.6	3.2	8.5
ø4	ø6	KQB2U04-06	11.4	29.3	11.2	9.1	18.2	12.6	13.6	3.2	5.6	4.2	11.9
ø6	ø8	KQB2U06-08	13.7	33.7	12.2	11.5	22.9	13.6	16.1	4.2	8	13.4	19.3
ø8	ø10	KQB2U08-10	16.6	38.3	13.8	14.6	28.3	16.1	17	4.2	8	25.6	32
ø10	ø12	KQB2U10-12	18.7	43	14	17.6	34.2	17	18.6	4.2	8	40	47.6
ø12	ø16	KQB2U12-16	24.6	47.4	15.6	19.8	38.5	18.6	20.8	4.2	8	57.4	67.6

Note 1) øD is maximum diameter.  
Note 2) Value of FEP tubing.

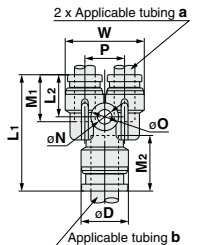



# Metal One-touch Fittings **KQB2 Series**

Applicable Tubing: Metric Size, Connection Thread: M, R, Rc

## Dimensions

### Bulkhead Connector: KQB2E



Applicable tubing O.D. (mm)	Connection Thread Rc	Model	T (M)	Width across flat		L1	L2	Mounting hole	M	Note 1 Effective area (mm <sup>2</sup> )	Weight (g)
				H1	H2						
ø3.2	1/4	KQB2E23-02	M10 x 1	17	12	31	14.8	11	12	3.4	27.5
	1/8	KQB2E04-01		14	12	25.8	9.7				16.9
ø4	1/4	KQB2E04-02	M10 x 1	17	12	30.9	14.8	11	12.6	5.6	27.1
	1/8	KQB2E06-01		17	17	24.2	6.1				25
ø6	1/4	KQB2E06-02	M14 x 1	19	19	31.6	13.5	15	13.6	13.1	33.2
	3/8	KQB2E06-03		19	19	33	14.9				34.8
ø8	1/8	KQB2E08-01		17	19	26.3	6.9				28.7
	1/4	KQB2E08-02	M15 x 1	19	19	32.4	13	16	16.1	26.1	34.2
	3/8	KQB2E08-03		19	19	34	14.6				35.9
ø10	1/4	KQB2E10-02	M18 x 1	19	21	31.6	11.6	19	17	41.5	44
	3/8	KQB2E10-03		19	21	33.6	13.6				40.2
ø12	3/8	KQB2E12-03	M20 x 1	21	24	34	12.8	21	18.6	58.3	52
	1/2	KQB2E12-04		24	24	39.6	18.4				62.5
ø16	3/8	KQB2E16-03	M27 x 1	29	30	35.3	11.2	28	20.8	96	111
	1/2	KQB2E16-04		30	30	40.6	16.5			113	118.2

Note) Value of FEP tubing.  
Value of nylon tubing for ø16 only.

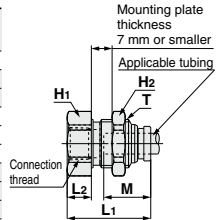

### Extended Male Elbow: KQB2W



Applicable tubing O.D. (mm)	Connection thread R, M	Model	H (Width across flat)	Note 1) øD	L1	L2	A*	M	Note 2) Effective area (mm <sup>2</sup> )	Weight (g)
ø4	1/8	KQB2W23-01S	10		13.6	31.3	32.3			15.3
	1/4	KQB2W23-02S	14			35.1	34.5			34.7
ø6	M5 x 0.8	KQB2W04-M5	8	9.1	13.7	31.6	33.2	12.6	3	14.1
	1/8	KQB2W04-01S	10		14.4	31.7	33.1		4	16.2
ø8	1/4	KQB2W04-02S	14			35.5	35.3			35.6
	M5 x 0.8	KQB2W06-M5	8	11.4	14.7	32.7	35.4	13.6	3	16
	1/8	KQB2W06-01S	10			32.8				17.8
ø10	1/4	KQB2W06-02S	14		15.9	36.6	37.6		10.9	37.2
	3/8	KQB2W06-03S	17			38	38.6			60.3
	1/8	KQB2W08-01S	12	13.7	18.6	37	40.7	16.1	20.5	28.9
ø12	1/4	KQB2W08-02S	14		19.1	40.2	42.3			39.2
	3/8	KQB2W08-03S	17			41.6	43.3			63.7
	1/4	KQB2W10-02S	14	16.6	21	46.6	50.2	17	33.5	42.1
ø16	3/8	KQB2W10-03S	17		22.6	47.7	52.3	18.6	47.7	64.5
	1/2	KQB2W10-04S	22			50.1	52			123
ø12	1/4	KQB2W12-02S	14	18.7	23.6	49	53.2			46
	3/8	KQB2W12-03S	17			53.2	56.1			58.2
ø16	3/8	KQB2W16-03S	19	24.6	26.3	57.6	64.1	20.8	71	89.6
	1/2	KQB2W16-04S	22		27.3	61.4	66.6		100	116

\* Reference dimensions after installation of R thread  
Note 1) øD is maximum diameter.  
Note 2) Value of FEP tubing.  
Value of nylon tubing for ø16 only.

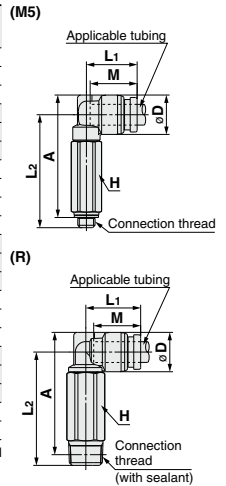

- KQ2
- KQB2**
- KS
- KX
- KM
- KF
- M
- H/DL
- L/LL
- KC
- KK
- KK130
- DM
- KDM
- KB
- KR
- KA
- KQG2
- KG
- KFG2
- MS
- KKA
- KP
- LQ
- MQR
- T
- IDK

# KQB2 Series

Applicable Tubing: Metric Size, Connection Thread: M, R, Rc

## Dimensions

### Female Connector: KQB2F

Applicable tubing O.D. (mm)	Connection Thread Rc	Model	H (Width across flat)	Note 1) $\phi D$	L1	L2	M	Note 2) Effective area (mm <sup>2</sup> )	Weight (g)
$\phi 3.2$	1/8	KQB2F23-01	12	8	23.3	9.8	12	3.4	9.3
	1/8	KQB2F04-01	12	8.7	23.7	9.8	12.6	5.6	9.7
$\phi 4$	1/4	KQB2F04-02	17		28.7	13.2			22.7
	1/8	KQB2F06-01	12	11.1	24.2	10	13.6	13.1	11.1
$\phi 6$	1/4	KQB2F06-02	17		29.2	13.4			24.3
	3/8	KQB2F06-03	19	30.6	14.2	25.8			
$\phi 8$	1/8	KQB2F08-01	14	13.4	26.3	9.6	16.1	26.1	17.1
	1/4	KQB2F08-02	17		31.3	13.7			26.8
	3/8	KQB2F08-03	19		32.7	14.4			28.4
$\phi 10$	1/4	KQB2F10-02	17	16.4	31.6	13.9	17	41.5	30.3
	3/8	KQB2F10-03	19		33	14.7			32
$\phi 12$	1/4	KQB2F12-02	19	18.5	32.6	13.3	18.6	58.3	39.4
	3/8	KQB2F12-03			34	14.7			33.9
	1/2	KQB2F12-04	24		39.3	18.4			52.9
$\phi 16$	3/8	KQB2F16-03	24	24.6	35.3	13.5	20.8	81	62.8
	1/2	KQB2F16-04			40.6	18.8		113	59.9

Note 1)  $\phi D$  is maximum diameter.

Note 2) Value of FEP tubing.

Value of nylon tubing for  $\phi 16$  only.

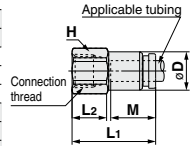

### Plug: KQB2P

Applicable fitting size $\phi d$	Model	$\phi D$	L	A	Weight (g)
$\phi 3.2$	KQB2P-23	5	28.9	16.9	2.8
$\phi 4$	KQB2P-04	6	29.6	17	4.3
$\phi 6$	KQB2P-06	8	30.8	17.2	9
$\phi 8$	KQB2P-08	10	33.7	17.6	16.3
$\phi 10$	KQB2P-10	12	34.6	17.6	25.4
$\phi 12$	KQB2P-12	14	36.5	17.9	37.8
$\phi 16$	KQB2P-16	18	38.6	17.8	69.2

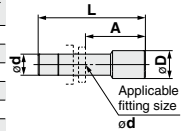

## Related Equipment

### Spatter cover

(Applicable tubing: FR soft nylon, FR double layer, FR three-layer)

Applicable tubing O.D. (mm)	Model
$\phi 6$	KQB2-06C-X1124
$\phi 8$	KQB2-08C-X1124
$\phi 10$	KQB2-10C-X1124



\* Since the spatter cover is designed for multi-layer (double layer, three-layer) tubing, sufficient effects cannot be obtained in foreign matter flow-in or followability for single-layer tubing.

\* The cover can be attached regardless of the single-layer/multi-layer tubing.

\* Cannot be used for union "Y" (KQB2U) 2-port side.

# Metal One-touch Fittings

Applicable Tubing: Inch Size, Connection Thread: UNF, NPT

# KQB2 Series

RoHS



## Applicable Tubing

Tubing material	FEP, PFA, Nylon, Soft nylon, Polyurethane, Polyolefin
Tubing O.D.	ø1/8", ø5/32", ø1/4", ø5/16", ø3/8", ø1/2"

## Specifications

Fluid	Air, Water <sup>Note 2)</sup>
Operating pressure range <sup>Note 1)</sup>	-100 kPa to 1 MPa <sup>Note 3)</sup>
Proof pressure	3.0 MPa
Ambient and fluid temperature <sup>Note 4)</sup>	-5 to 150°C (No freezing) <sup>Note 3)</sup>
Lubricant	Grease-free specification
Seal on the threads	With sealant

Note 1) Avoid using in a vacuum holding application such as a leak tester, since there is leakage.  
 Note 2) Deionized water is not recommended for use as it may affect the material used in the fittings. In addition, it is known to degrade the water quality.  
 Note 3) Check the operating pressure range and operating temperature range of the tubing.  
 Note 4) It is recommended that you use the inner sleeve in the following conditions (Except ø1/8"):

- When using in an environment where the fluid temperature changes drastically.
- When using at a high temperature.

### \* Temperature Condition of Mounting the Inner Sleeve

Tubing	Temperature
FEP tubing/TH Series	80°C or more
Super PFA tubing/TL Series	120°C or more

## Spare Parts

Description	Tubing O.D.	Part no.	Material
Gasket	—	M-5G3	Stainless steel 316, Special FKM
Bulkhead nut	ø1/8" ø5/32"	KQB201-P01	C3604 (Electroless nickel plated)
	ø1/4"	KQB207-P01	
	ø5/16"	KQB209-P01	
	ø3/8"	KQB211-P01	
	ø1/2"	KQB213-P01	

## Cross Reference Table of the Inner Sleeve

Tubing O.D.	Tubing material		Applicable inner sleeve	
	TH/THI (FEP)	TL/TIL (Super PFA)	Part no.	Length
ø5/32"	TH0402	—	TJ-0402	18
	TH0425	—	TJ-0425	18
ø1/4"	—	TL0403	TJ-0403	18
	TIHB07	TIL07	TJ-0604	19
ø5/16"	TIHA07	—	TJ-0746	19
	TH0806	TL0806	TJ-0806	20.5
ø3/8"	TIHB11	TIL11	TJ-1065	23
	TIHA11	—	TJ-1107	23
ø1/2"	TIH13	TIL13	TJ-1395	24

\* C2700 + Electroless nickel plated is used for the TJ series.

## Construction

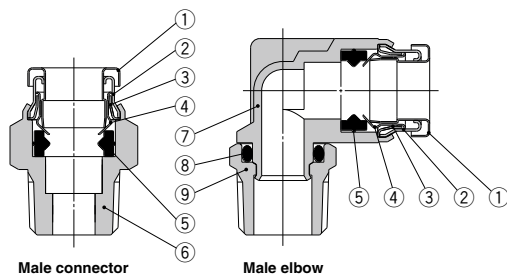

## Component Parts

No.	Description	Material
1	Release button	Stainless steel 304
2	Guide 1	Stainless steel 304
3	Guide 2	Stainless steel 304
4	Chuck	Stainless steel 304
5	Seal	Special FKM (Fluoro coated)
6	Male connector body	C3604 (Electroless nickel plated)
7	Male elbow body	Stainless steel 316
8	O-ring	Special FKM (Fluoro coated)
9	Stud	C3604 (Electroless nickel plated)

# KQB2 Series

Applicable Tubing: Inch Size, Connection Thread: UNF, NPT

## Dimensions

### Male Connector: KQB2H



Applicable tubing O.D. (inch)	Connection thread UNF, NPT	Model	H (Width across flat)	Note 1) $\phi D$	L	A*	M	Note 2) Effective area (mm <sup>2</sup> )	Weight (g)
$\phi 1/8"$	10-32UNF	KQB2H01-32	8	8	16.5	13.5	12	3	3.5
	1/8	KQB2H01-N01S	11.11		17.1	13.9		3.4	7.9
	1/4	KQB2H01-N02S	14.29		20.9	16.5		18	
$\phi 5/32"$	10-32UNF	KQB2H03-32	11.11	8.7	17.1	14.1	12.6	4	6.5
	1/8	KQB2H03-N01S			17	13.8		5.6	7.4
	1/4	KQB2H03-N02S			20.9	16.5		17.5	
$\phi 1/4"$	10-32UNF	KQB2H07-32	12.7	11.2	19	16	13.5	4	9
	1/8	KQB2H07-N01S	14.29		20	16.8		13.1	9.8
	1/4	KQB2H07-N02S	17.46		20.6	16.2		15.1	31
	3/8	KQB2H07-N03S	17.46		23.8	19.1		13.8	14.9
	1/2	KQB2H09-N02S	17.46		24.6	19.9		26.1	28.3
$\phi 5/16"$	1/8	KQB2H09-N01S	14.29	13.4	25	21.8	16.1	26.1	21.5
	1/4	KQB2H11-N02S			26.3	21.9		22.3	
	3/8	KQB2H11-N03S			23.6	18.9		41.5	24.4
	1/2	KQB2H11-N04S			22.23	28.3		21.9	55
	3/8	KQB2H13-N02S			22.23	30.5		26.1	39.4
$\phi 3/8"$	1/8	KQB2H11-N01S	17.46	16	25	21.8	16.6	26.1	21.5
	1/4	KQB2H11-N02S			26.3	21.9		22.3	
	3/8	KQB2H11-N03S			23.6	18.9		41.5	24.4
$\phi 1/2"$	1/2	KQB2H11-N04S	22.23	19.3	28.3	21.9	18.5	58.3	55
	3/8	KQB2H13-N03S	22.23		28.4	23.7		36.8	
	1/2	KQB2H13-N04S	22.23		28.4	22		46.1	

\* Reference dimensions after installation of NPT thread  
 Note 1)  $\phi D$  is maximum diameter.  
 Note 2) Value of FEP tubing.

(10-32UNF)

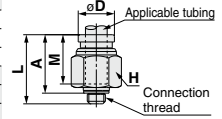

(NPT)

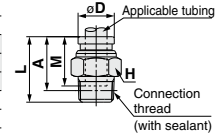

### Hexagon Socket Head Male Connector: KQB2S



Applicable tubing O.D. (inch)	Connection thread UNF, NPT	Model	H (Width across flat)	Note 1) $\phi D$	L	A*	M	Note 2) Effective area (mm <sup>2</sup> )	Weight (g)
$\phi 1/8"$	10-32UNF	KQB2S01-32	2	9	16.5	13.5	12	3	3.9
	10-32UNF	KQB2S03-32	2	9	17.1	14.1	12.6	4	3.9
$\phi 5/32"$	1/8	KQB2S03-N01S	2.78	11	21.4	18.2	12.6	4.1	8.9
	10-32UNF	KQB2S07-32	2	12	19.5	16.5		4	7.5
$\phi 1/4"$	1/8	KQB2S07-N01S	4.76	12	20.5	17.3	13.5	10	8.5
	1/4	KQB2S07-N02S			14	16.1		10.7	14.1
	3/8	KQB2S07-N03S			18	21.5		16.8	23.8
	1/2	KQB2S09-N01S			14	24.7		21.5	17.2
$\phi 5/16"$	1/4	KQB2S09-N02S	5.56	14	23.1	18.7	16.1	23.3	13.4
	3/8	KQB2S09-N03S	6.35		18	18.4		17.2	18.7
	1/2	KQB2S11-N01S	5.56		17	25.2		22	17.2
$\phi 3/8"$	1/4	KQB2S11-N02S	6.35	17	27.1	22.7	16.6	39	22.2
	3/8	KQB2S11-N03S			18	18.9		25	
	1/2	KQB2S11-N04S			22	23.6		17.2	40.6
	3/8	KQB2S13-N02S			8	20		30.5	26.1
$\phi 1/2"$	3/8	KQB2S13-N03S	9.53	20	29.4	24.7	18.5	60	30.4
	1/2	KQB2S13-N04S			22	25.5		19.1	36.5

\* Reference dimensions after installation of NPT thread  
 Note 1)  $\phi D$  is maximum diameter.  
 Note 2) Value of FEP tubing.

(10-32UNF)

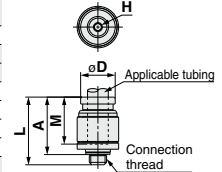

(NPT)

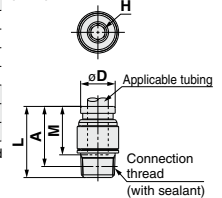

### Straight Union: KQB2H



Applicable tubing O.D. (inch)	Model	$\phi D$ Note 1)	L	M	Note 2) Effective area (mm <sup>2</sup> )	Weight (g)
$\phi 1/8"$	KQB2H01-00	9	25	12	3.4	6.8
$\phi 5/32"$	KQB2H03-00	9	26.2	12.6	5.6	6.8
$\phi 1/4"$	KQB2H07-00	12	28	13.5	13.1	11.5
$\phi 5/16"$	KQB2H09-00	14	33.2	16.1	26.1	17.4
$\phi 3/8"$	KQB2H11-00	16	34.2	16.6	41.5	23.7
$\phi 1/2"$	KQB2H13-00	20	38	18.5	58.3	37

Note 1)  $\phi D$  is maximum diameter.  
 Note 2) Value of FEP tubing.

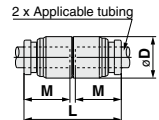

# Metal One-touch Fittings **KQB2 Series**

Applicable Tubing: Inch Size, Connection Thread: UNF, NPT

## Dimensions

### Male Elbow: KQB2L



Applicable tubing O.D. (inch)	Connection thread UNF, NPT	Model	H (With across flat)	Note 1) øD	L1	L2	A*	M	Note 2) Effective area (mm <sup>2</sup> )	Weight (g)
ø1/8"	10-32UNF	KQB2L01-32	8	8.3	13.1	14.8	16	12	2.6	6.5
	1/8	KQB2L01-N01S	11.11		13.6	14.9	15.8		3	8.8
	1/4	KQB2L01-N02S	14.29		13.7	15.2	16.8		3.5	7
ø5/32"	10-32UNF	KQB2L03-32	8	9.1	14.4	15.3	16.6	12.6	4.2	9.7
	1/8	KQB2L03-N01S	11.11		14.7	16.5	19.3		3.5	9.1
	1/4	KQB2L03-N02S	14.29		15.9	20.4	21.8		11.4	20.3
ø1/4"	10-32UNF	KQB2L07-32	8	11.7	14.7	16.5	19.3	13.5	3.5	9.1
	1/8	KQB2L07-N01S	11.11		16.6	19.2	11.4		20.3	
	1/4	KQB2L07-N02S	14.29		22.2	23.3	33.7		35.8	
ø5/16"	10-32UNF	KQB2L09-N01S	12.7	13.7	18.6	18.3	21.9	16.1	21.6	15.8
	1/4	KQB2L09-N02S	14.29		19.1	21.5	23.9		21.6	21.9
	3/8	KQB2L09-N03S	17.46		23.3	25.4	35		20.5	
ø3/8"	10-32UNF	KQB2L11-N01S	12.7	16	20	19.4	24.2	16.6	21.6	20.5
	1/4	KQB2L11-N02S	14.29		22.6	26.2	23.9		35.2	35.8
	3/8	KQB2L11-N03S	17.46		24.4	27.7	63.1		30.1	
ø1/2"	10-32UNF	KQB2L13-N02S	22.23	19.6	22.7	24.4	29.8	18.5	50.2	37.9
	1/4	KQB2L13-N02S	14.29		26.1	31.2	63.8		30.1	
	3/8	KQB2L13-N03S	17.46		29.9	33.3	63.8		30.1	

\* Reference dimensions after installation of NPT thread  
 Note 1) øD is maximum diameter.  
 Note 2) Value of FEP tubing.

(10-32UNF)

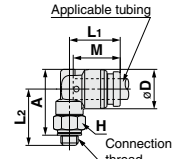

(NPT)

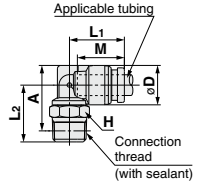

### Male Branch Tee: KQB2T



Applicable tubing O.D. (inch)	Connection thread UNF, NPT	Model	H (With across flat)	Note 1) øD	L1	L2	A*	M	Note 2) Effective area (mm <sup>2</sup> )	Weight (g)
ø1/8"	10-32UNF	KQB2T01-32	8	8.3	13.1	14.8	16	12	3.2	8.2
	1/8	KQB2T01-N01S	11.11		13.6	14.9	15.8		3.4	10.6
	1/4	KQB2T01-N02S	14.29		13.7	15.2	16.8		4.5	9.1
ø5/32"	10-32UNF	KQB2T03-32	8	9.1	14.4	15.3	16.6	12.6	6	11.6
	1/8	KQB2T03-N01S	11.11		14.7	16.5	19.3		4.5	12.3
	1/4	KQB2T03-N02S	14.29		15.9	20.4	21.8		13.9	23.8
ø1/4"	10-32UNF	KQB2T07-32	8	11.7	14.7	16.5	19.3	13.5	3.5	9.1
	1/8	KQB2T07-N01S	11.11		16.6	19.2	11.4		20.3	
	1/4	KQB2T07-N02S	14.29		22.2	23.3	37.1		21.2	
ø5/16"	10-32UNF	KQB2T09-N01S	12.7	13.7	18.6	18.3	21.9	16.1	26.3	27.1
	1/4	KQB2T09-N02S	14.29		19.1	21.5	23.9		26.3	40.3
	3/8	KQB2T09-N03S	17.46		23.3	25.4	28.1		31.1	
ø3/8"	10-32UNF	KQB2T11-N01S	12.7	16	20	19.4	24.2	16.6	40.8	31.1
	1/4	KQB2T11-N02S	14.29		22.6	26.2	43.1		43.1	
	3/8	KQB2T11-N03S	17.46		24.4	27.7	70.4		41.8	
ø1/2"	10-32UNF	KQB2T13-N02S	22.23	19.6	22.7	24.4	29.8	18.5	57.2	49
	1/4	KQB2T13-N02S	14.29		26.1	31.2	74.9		41.8	
	3/8	KQB2T13-N03S	17.46		29.9	33.3	74.9		41.8	

\* Reference dimensions after installation of NPT thread  
 Note 1) øD is maximum diameter.  
 Note 2) Value of FEP tubing.

(10-32UNF)

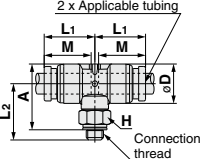

(NPT)

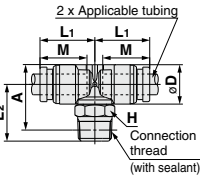

### Union Elbow: KQB2L



Applicable tubing O.D. (inch)	Model	Note 1) øD	L	A	Q	M	øN	øO	Note 2) Effective area (mm <sup>2</sup> )	Weight (g)
ø1/8"	KQB2L01-00	8.3	13.6	19.3	2.9	12	3.2	5.6	3	6.3
ø5/32"	KQB2L03-00	9.1	14.6	20.5	3.1	12.6	3.2	5.6	4.2	7.4
ø1/4"	KQB2L07-00	11.7	16.7	23.2	3.7	13.5	3.2	5.6	11.4	11.5
ø5/16"	KQB2L09-00	13.7	20.1	29.1	5	16.1	4.2	8	21.6	20.2
ø3/8"	KQB2L11-00	16	21.4	31.1	5.7	16.6	4.2	8	35.2	28.2
ø1/2"	KQB2L13-00	19.6	24.9	35.3	6.4	18.5	4.2	8	50.2	41.7

Note 1) øD is maximum diameter.  
 Note 2) Value of FEP tubing.

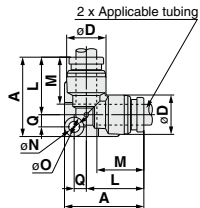

KQ2

KQB2

KS  
KX

KM

KF

M

H/DL  
L/L

KC

KK

KK130

DM

KDM

KB

KR

KA

KQG2

KG

KFG2

MS

KKA

KP

LQ

MQR

T

IDK

# KQB2 Series

Applicable Tubing: Inch Size, Connection Thread: UNF, NPT

## Dimensions

### Bulkhead Union: KQB2E



Applicable tubing O.D. (inch)	Model	T (UNF)	H (Width across flat)	L	Mounting hole	M	Note 1) Effective area (mm <sup>2</sup> )	Weight (g)
ø1/8"	KQB2E01-00	7/16-20UNF	14.29	34.2	12.5	12	3.4	21.8
ø5/32"	KQB2E03-00	7/16-20UNF	14.29	34.4	12.5	12.6	5.6	21.6
ø1/4"	KQB2E07-00	1/2-20UNF	17.46	36.2	14	13.5	13.1	30.2
ø5/16"	KQB2E09-00	5/8-18UNF	22.23	41.2	17	16.1	26.1	43.9
ø3/8"	KQB2E11-00	3/4-16UNF	22.23	42.4	20.5	16.6	41.5	64.2
ø1/2"	KQB2E13-00	7/8-14UNF	25.4	47	23.5	18.5	58.3	94.2

Note 1) Value of FEP tubing.

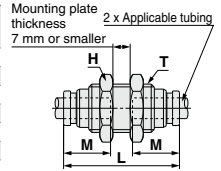

### Union Tee: KQB2T



Applicable tubing O.D. (inch)	Model	Note 1) øD	L	A	Q	M	øN	øO	Note 2) Effective area (mm <sup>2</sup> )	Weight (g)
ø1/8"	KQB2T01-00	8.3	13.6	20.5	4.1	12	3.2	5.6	3.4	7.9
ø5/32"	KQB2T03-00	9.1	14.6	21.8	4.4	12.6	3.2	5.6	6.4	9.5
ø1/4"	KQB2T07-00	11.7	16.7	24.7	5.2	13.5	3.2	5.6	13.4	14.7
ø5/16"	KQB2T09-00	13.7	20.1	31.1	7	16.1	4.2	8	25.6	24.4
ø3/8"	KQB2T11-00	16	21.4	33.4	8	16.6	4.2	8	40	34.7
ø1/2"	KQB2T13-00	19.6	24.9	37.9	9	18.5	4.2	8	57.4	52.3

Note 1) øD is maximum diameter.  
Note 2) Value of FEP tubing.

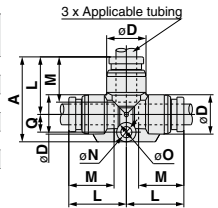

### Union "Y": KQB2U



Applicable tubing O.D. (inch)	Model	Note 1) øD	W	L1	L2	P	M	øN	øO	Note 2) Effective area (mm <sup>2</sup> )	Weight (g)
ø1/8"	KQB2U01-00	8.3	16.4	29	11	8.1	12	3.2	5.6	3.4	9.2
ø5/32"	KQB2U03-00	9.1	18.2	30.4	11.3	9.1	12.6	3.2	5.6	4.2	11.1
ø1/4"	KQB2U07-00	11.7	23.9	34.5	12.1	12.2	13.5	3.2	5.6	13.4	19.6
ø5/16"	KQB2U09-00	13.7	28.3	40.1	14.1	14.6	16.1	4.2	8	25.6	29.7
ø3/8"	KQB2U11-00	16	33.2	42.2	14	17.2	16.6	4.2	8	40	43.1
ø1/2"	KQB2U13-00	19.6	40.2	47.3	15.8	20.6	18.5	4.2	8	57.4	66.4

Note 1) øD is maximum diameter.  
Note 2) Value of FEP tubing.

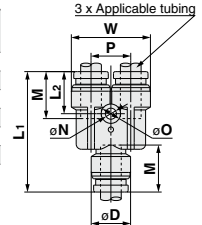

### Different Diameter Tee: KQB2T



Applicable tubing O.D. (inch)	Model	Note 1) øD1	Note 1) øD2	L1	L2	L3	Q	M1	M2	øN	øO	Note 2) Effective area (mm <sup>2</sup> )	Weight (g)
ø1/8" ø5/32"	KQB2T01-03	9.1	8.3	14.2	14.1	21.1	4.1	12.6	12	3.2	5.6	3.8	8.5
ø5/32" ø1/4"	KQB2T03-07	11.7	9.1	15.5	15.9	22.7	4.4	13.5	12.6	3.2	5.6	7.1	11.7
ø1/4" ø5/16"	KQB2T07-09	13.7	11.7	19.3	17.6	29.6	6.3	16.1	13.5	4.2	8	16.4	20.2
ø5/16" ø3/8"	KQB2T09-11	16	13.7	20.6	21	31.7	7.1	16.6	16.1	4.2	8	36	28.9
ø3/8" ø1/2"	KQB2T11-13	19.6	16	23.3	23	35.4	8.1	18.5	16.6	4.2	8	56	41.8

Note 1) øD1, øD2 are maximum diameters.  
Note 2) Value of FEP tubing.

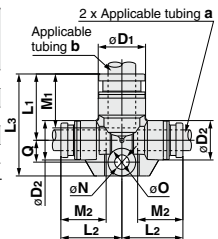

### Plug-in Reducer: KQB2R



Applicable tubing O.D. (inch)	Applicable fitting size ød	Model	Note 1) øD	L	A	M	Note 2) Effective area (mm <sup>2</sup> )	Weight (g)
ø1/8"	ø5/32"	KQB2R01-03	9	32.9	20.3	12	3.4	4.9
ø5/32"	ø1/4"	KQB2R03-07	9	33.7	20.2	12.6	5.6	7.4
ø1/4"	ø5/16"	KQB2R07-09	12	38.4	22.3	13.5	13.1	12.5
ø5/16"	ø3/8"	KQB2R09-11	14	41.6	25	16.1	26.1	17.7
ø3/8"	ø1/2"	KQB2R11-13	17	39.8	21.3	16.6	41.5	24.7

Note 1) øD is maximum diameter.  
Note 2) Value of FEP tubing.

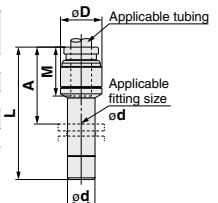

# Metal One-touch Fittings **KQB2 Series**

Applicable Tubing: Inch Size, Connection Thread: UNF, NPT

## Dimensions

### Different Diameter Straight: KQB2H



Applicable tubing O.D. (inch)		Model	øD Note 1)	L	M <sub>1</sub>	M <sub>2</sub>	Note 2) Effective area (mm <sup>2</sup> )	Weight (g)
a	b							
ø1/8"	ø5/32"	KQB2H01-03	9	25.6	12	12.6	3.4	6.8
ø5/32"	ø1/4"	KQB2H03-07	12	27.1	12.6	13.5	5.6	11.9
ø1/4"	ø5/16"	KQB2H07-09	14	30.6	13.5	16.1	13.1	16.8
ø5/16"	ø3/8"	KQB2H09-11	16	33.7	16.1	16.6	26.1	23.9
ø3/8"	ø1/2"	KQB2H11-13	20	36.1	16.6	18.5	41.5	38.8

Note 1) øD is maximum diameter.  
Note 2) Value of FEP tubing.

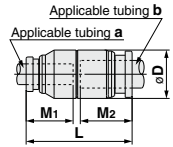

### Different Diameter Union "Y": KQB2U



Applicable tubing O.D. (inch)		Model	Note 1) øD	L <sub>1</sub>	L <sub>2</sub>	P	W	M <sub>1</sub>	M <sub>2</sub>	øN	øO	Note 2) Effective area (mm <sup>2</sup> )	Weight (g)
a	b												
ø1/8"	ø5/32"	KQB2U01-03	9.1	27	10.8	8.1	16.4	12	12.6	3.2	5.6	3.2	8.5
ø5/32"	ø1/4"	KQB2U03-07	11.7	28.8	11.4	9.1	18.2	12.6	13.5	3.2	5.6	4.2	11.8
ø1/4"	ø5/16"	KQB2U07-09	13.7	33.8	12	12.2	23.9	13.5	16.1	4.2	8	13.4	20
ø5/16"	ø3/8"	KQB2U09-11	16	38.3	13.8	14.6	28.3	16.1	16.6	4.2	8	25.6	31
ø3/8"	ø1/2"	KQB2U11-13	19.6	40.5	13.7	17.2	33.2	16.6	18.5	4.2	8	40	45

Note 1) øD is maximum diameter.  
Note 2) Value of FEP tubing.

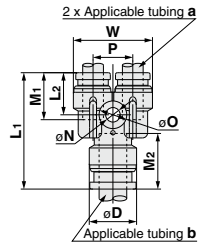

### Bulkhead Connector: KQB2E



Applicable tubing O.D. (inch)	Connection thread NPT	Model	T (UNF)	Width across flat		L <sub>1</sub>	L <sub>2</sub>	Mounting hole	M	Note 1) Effective area (mm <sup>2</sup> )	Weight (g)
				H <sub>1</sub>	H <sub>2</sub>						
ø1/8"	1/4	KQB2E01-N02	7/16-20UNF	17.46	14.29	32.8	15.3	12.5	12	3.4	34.1
ø5/32"	1/4	KQB2E03-N02	7/16-20UNF	17.46	14.29	32.6	15.3	12.5	12.6	5.6	33.5
ø1/4"	1/4	KQB2E07-N02	1/2-20UNF	17.46	17.46	33.1	14.8	14	13.5	5.1	36.5
ø5/16"	3/8	KQB2E09-N03	5/8-18UNF	22.23	22.23	35.8	15.1	17	16.1	26.1	56.1
ø3/8"	3/8	KQB2E11-N03	3/4-18UNF	22.23	22.23	35.2	13.7	20.5	16.6	41.5	62.9
ø1/2"	3/8	KQB2E13-N03	7/8-14UNF	23.81	25.4	34.6	11	23.5	18.5	58.3	76.6
	1/2	KQB2E13-N04									

Note 1) Value of FEP tubing.

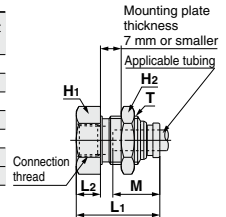

### Extended Male Elbow: KQB2W



Applicable tubing O.D. (inch)	Connection thread NPT	Model	H (Width across flat)	Note 1) øD	L <sub>1</sub>	L <sub>2</sub>	A*	M	Note 2) Effective area (mm <sup>2</sup> )	Weight (g)				
											ø1/8"	1/8	KQB2W01-N01S	11.11
1/4	KQB2W01-N02S	14.29	35.4	35.1	37.3									
ø5/32"	1/8	KQB2W03-N01S	11.11	9.1	14.4	32	33.3	12.6	4	20.3				
	1/4	KQB2W03-N02S	14.29								35.8	35.9	38.2	
ø1/4"	1/8	KQB2W07-N01S	11.11	11.7	15.9	33.3	35.9	13.5	10.9	22.1				
	1/4	KQB2W07-N02S	14.29								37.1	38.5	39.9	
	3/8	KQB2W07-N03S	17.46								38.9	40	65.6	
	1/8	KQB2W09-N01S	12.7								18.6	34.7	38.3	30.4
ø5/16"	1/4	KQB2W09-N02S	14.29	13.7	19.1	40.2	42.6	16.1	20.5	41.6				
	3/8	KQB2W09-N03S	17.46								42	44.1	68.5	
	1/4	KQB2W11-N02S	14.29								47.2	50.8	44.9	
	3/8	KQB2W11-N03S	17.46								45.4	48.7	67.8	
ø3/8"	1/2	KQB2W11-N04S	22.23	16	21	49.2	50.8	16.6	33.5	124.2				
	1/4	KQB2W13-N02S	14.29								22.7	49	54.4	51.1
	3/8	KQB2W13-N03S	17.46								19.6	23.7	50.7	55.8
ø1/2"	1/2	KQB2W13-N04S	22.23	19.6	23.7	54.5	57.9	18.5	47.7	125.9				

\* Reference dimensions after installation of NPT thread  
Note 1) øD is maximum diameter.  
Note 2) Value of FEP tubing.

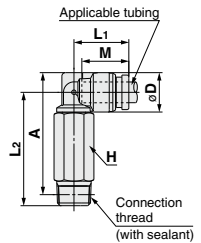

KQ2

KQB2

KS  
KX

KM

KF

M

H/DL  
L/L

KC

KK

KK130

DM

KDM

KB

KR

KA

KQ62

KG

KFG2

MS

KKA

KP

LQ

MQR

T

IDK

# KQB2 Series

Applicable Tubing: Inch Size, Connection Thread: UNF, NPT

## Dimensions

### Female Connector: KQB2F

Applicable tubing O.D. (inch)	Connection thread NPT	Model	H (Width across flat)	Note 1) $\phi D$	L1	L2	M	Note 2) Effective area (mm <sup>2</sup> )	Weight (g)
$\phi 1/8"$	1/8	KQB2F01-N01	12.7	8	24.1	10.4	12	3.4	11.3
	1/4	KQB2F01-N02	17.46		29.1	13.7			25.4
$\phi 5/32"$	1/8	KQB2F03-N01	12.7	8.7	24.6	10.5	12.6	5.6	11.8
	1/4	KQB2F03-N02	17.46		29.6	13.8			25.9
$\phi 1/4"$	1/8	KQB2F07-N01	12.7	11.2	25	10.7	13.5	13.1	13
	1/4	KQB2F07-N02	17.46		30	14.1			27.5
	3/8	KQB2F07-N03	22.23		31.2	14.6			41.1
$\phi 5/16"$	1/8	KQB2F09-N01	14.29	13.4	27.2	10.3	16.1	26.1	18.8
	1/4	KQB2F09-N02	17.46		32.2	14.3			30.1
	3/8	KQB2F09-N03	22.23		33.4	14.8			44
$\phi 3/8"$	1/4	KQB2F11-N02	17.46	16	32.1	14.4	16.6	41.5	32.9
	3/8	KQB2F11-N03	22.23		33.3	14.9			47
	1/2	KQB2F11-N04	23.81		38.6	18.6			50.4
$\phi 1/2"$	3/8	KQB2F13-N03	22.23	19.3	34.6	14.7	18.5	58.3	51.3
	1/2	KQB2F13-N04	23.81		39.9	18.8			55.1

Note 1)  $\phi D$  is maximum diameter.  
Note 2) Value of FEP tubing.

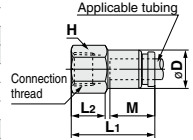

### Plug: KQB2P

Applicable fitting size $\phi d$	Model	$\phi D$	L	A	Weight (g)
$\phi 1/8"$	KQB2P-01	5	28.9	16.9	2.8
$\phi 5/32"$	KQB2P-03	6	29.6	17	4.3
$\phi 1/4"$	KQB2P-07	8	30.3	16.8	9.4
$\phi 5/16"$	KQB2P-09	10	33.7	17.6	16.3
$\phi 3/8"$	KQB2P-11	11	34.1	17.5	22.2
$\phi 1/2"$	KQB2P-13	14	36.4	17.9	40.7

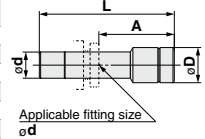



# Metal One-touch Fittings

Applicable Tubing: Metric Size, Connection Thread: G\*

\* Conforming to ISO16030

# KQB2 Series



## Applicable Tubing

Tubing material	FEP, PFA, Nylon, Soft nylon, Polyurethane, Polyolefin
Tubing O.D.	ø4, ø6, ø8, ø10, ø12, ø16

## Specifications

<b>Fluid</b>	Air, Water <sup>Note 2)</sup>
<b>Operating pressure range</b> <sup>Note 1)</sup>	-100 kPa to 1 MPa <sup>Note 3)</sup>
<b>Proof pressure</b>	3.0 MPa
<b>Ambient and fluid temperature</b> <sup>Note 4)</sup>	-5 to 150°C (No freezing) <sup>Note 3)</sup>
<b>Lubricant</b>	Grease-free specification
<b>Seal on the threads</b>	O-ring seal

- Note 1) Avoid using in a vacuum holding application such as a leak tester, since there is leakage.  
 Note 2) Deionized water is not recommended for use as it may affect the material used in the fittings. In addition, it is known to degrade the water quality.  
 Note 3) Check the operating pressure range and operating temperature range of the tubing.  
 Note 4) It is recommended that you use the inner sleeve in the following conditions:
- When using in an environment where the fluid temperature changes drastically.
  - When using at a high temperature.

### \* Temperature Condition of Mounting the Inner Sleeve

Tubing	Temperature
FEP tubing/TH Series	80°C or more
Super PFA tubing/TL Series	120°C or more

## Spare Parts

Description	Tubing O.D.	Part no.	Material
Bulkhead nut	ø4	<b>KQB223-P01</b>	C3604 (Electroless nickel plated)
	ø6	<b>KQB206-P01</b>	
	ø8	<b>KQB208-P01</b>	
	ø10	<b>KQB210-P01</b>	
	ø12	<b>KQB212-P01</b>	
	ø16	<b>KQB216-P01</b>	

Description	Thread size	Part no.	Material
G thread O-ring	G1/8	<b>KQB2-G01</b>	Special FKM (Fluoro coated)
	G1/4	<b>KQB2-G02</b>	
	G3/8	<b>KQB2-G03</b>	
	G1/2	<b>KQB2-G04</b>	

## Cross Reference Table of the Inner Sleeve

Tubing O.D.	Tubing material			Applicable inner sleeve	
	TUS (Soft polyurethane)	TH/THI (FEP)	TL/TIL (Super PFA)	Part no.	Length
ø4	—	TH0402	—	<b>TJ-0402</b>	18
	TUS0425	TH0425	—	<b>TJ-0425</b>	18
	—	—	TL0403	<b>TJ-0403</b>	18
ø6	TUS0604	TH0604	TL0604	<b>TJ-0604</b>	19
	TUS0805	—	—	<b>TJ-0805</b>	20.5
ø8	—	TH0806	TL0806	<b>TJ-0806</b>	20.5
	TUS1065	—	—	<b>TJ-1065</b>	23
ø10	—	TH1075	—	<b>TJ-1075</b>	23
	—	TH1008	TL1008	<b>TJ-1008</b>	23
	TUS1208	—	—	<b>TJ-1008</b>	24
ø12	—	TH1209	—	<b>TJ-1209</b>	24
	—	TH1210	TL1210	<b>TJ-1210</b>	24
	—	—	—	<b>TJ-1210</b>	24

\* C2700 + Electroless nickel plated is used for the TJ series.

## Construction

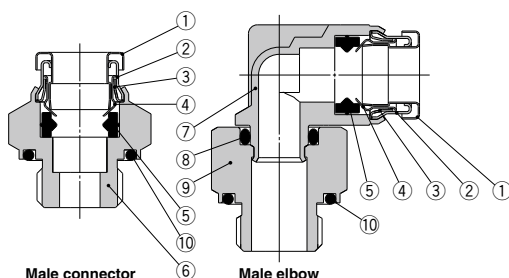

## Component Parts

No.	Description	Material
1	Release button	Stainless steel 304
2	Guide 1	Stainless steel 304
3	Guide 2	Stainless steel 304
4	Chuck	Stainless steel 304
5	Seal	Special FKM (Fluoro coated)
6	Male connector body	C3604 (Electroless nickel plated)
7	Male elbow body	Stainless steel 316
8	O-ring	Special FKM (Fluoro coated)
9	Stud	C3604 (Electroless nickel plated)
10	G thread O-ring	Special FKM (Fluoro coated)

# KQB2 Series

Applicable Tubing: Metric Size, Connection Thread: G

## Dimensions

### Male Connector: KQB2H



Applicable tubing O.D. (mm)	Connection thread G	Model	H (Width across flat)	Note 1) $\phi D$	$\phi d$	L	A	M	Note 2) Effective area (mm <sup>2</sup> )	Weight (g)
$\phi 4$	1/8	KQB2H04-G01	14	8.7	13.8	16.6	11.1	12.6	5.6	9.2
	1/4	KQB2H04-G02	19		17.8	20.6	14.1			23.6
$\phi 6$	1/8	KQB2H06-G01	14	11.1	13.8	17.6	12.1	13.6	13.1	8.9
	1/4	KQB2H06-G02	19		17.8	20.5	14			21.6
	3/8	KQB2H06-G03	22		21.8	23.4	15.9			38.3
$\phi 8$	1/8	KQB2H08-G01	14	13.4	13.8	23.9	18.4	16.1	26.1	13.2
	1/4	KQB2H08-G02	19		17.8	21.2	14.7			19.1
	3/8	KQB2H08-G03	22		21.8	24	16.5			35.2
$\phi 10$	1/8	KQB2H10-G01	17	16.4	13.8	25.1	19.6	17	41.5	26.1
	1/4	KQB2H10-G02	19		17.8	24.9	18.4			24.8
	3/8	KQB2H10-G03	22		21.8	23.3	15.8			30.9
	1/2	KQB2H10-G04	27		26.5	27.7	18.7			64.4
$\phi 12$	1/4	KQB2H12-G02	19	18.5	17.8	27.7	21.2	18.6	58.3	26.3
	3/8	KQB2H12-G03	22		21.8	23.5	16			25.5
	1/2	KQB2H12-G04	27		26.5	27.9	18.9			58
$\phi 16$	3/8	KQB2H16-G03	24	24.6	21.8	31.3	23.8	20.8	81	44.5
	1/2	KQB2H16-G04	27		26.5	27.3	18.3			113

Note 1)  $\phi D$  is maximum diameter.

Note 2) Value of FEP tubing.

Value of nylon tubing for  $\phi 16$  only.

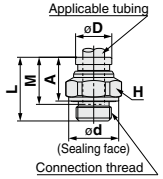

### Hexagon Socket Head Male Connector: KQB2S



Applicable tubing O.D. (mm)	Connection thread G	Model	H (Width across flat)	Note 1) $\phi D$	$\phi d$	L	A	M	Note 2) Effective area (mm <sup>2</sup> )	Weight (g)
$\phi 4$	1/8	KQB2S04-G01	3	14	14	20.4	14.9	12.6	4.1	13.5
$\phi 6$	1/8	KQB2S06-G01	4	14	14	20.6	15.1	13.6	10	12.1
	1/4	KQB2S06-G02		18	18					10.7
$\phi 8$	1/8	KQB2S08-G01	5	14	14	23.9	18.4	16.1	23.3	17.2
	1/4	KQB2S08-G02	6	18	18	22.9	16.4			20.1
	3/8	KQB2S08-G03		22	22	23.1	15.6			31.1
$\phi 10$	1/8	KQB2S10-G01	5	17	14	25.1	19.6	17	39	17.2
	1/4	KQB2S10-G02	8	18	18	24.9	18.4			20.4
	3/8	KQB2S10-G03		22	22	16.5	31.2			
	1/2	KQB2S10-G04		27	26.5	15	45.3			
$\phi 12$	1/4	KQB2S12-G02	8	19	18	27.7	21.2	18.6	60	46
	3/8	KQB2S12-G03	10	22	22	24.9	17.4			27.4
	1/2	KQB2S12-G04		27	26.5	15.9	42.6			
$\phi 16$	3/8	KQB2S16-G03	10	24.6	22	31.3	23.8	20.8	81	41
	1/2	KQB2S16-G04	12	27	26.5	27.8	18.8			113

Note 1)  $\phi D$  is maximum diameter.

Note 2) Value of FEP tubing.

Value of nylon tubing for  $\phi 16$  only.

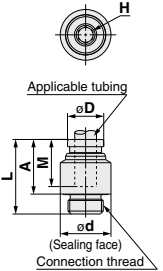

## Dimensions

### Male Elbow: KQB2L



Applicable tubing O.D. (mm)	Connection thread G	Model	H (Width across flat)	Note 1) øD	ød	L1	L2	A	M	Note 2) Effective area (mm <sup>2</sup> )	Weight (g)
ø4	1/8	KQB2L04-G01	14	9.1	13.8	14.4	18.9	17.9	12.6	4.2	15.6
	1/4	KQB2L04-G02	19		17.8	22.3	20.3	33			
ø6	1/8	KQB2L06-G01	14	11.4	13.8	20	20.2	13.6	11.4	17.2	
	1/4	KQB2L06-G02	19		17.8	23.4	22.6			34.6	
	3/8	KQB2L06-G03	22		21.8	25.9	24.1			50.2	
ø8	1/8	KQB2L08-G01	14	13.7	13.8	18.6	21.3	22.6	16.1	21.6	20.2
	1/4	KQB2L08-G02	19		17.8	19.1	24.7	25			36
	3/8	KQB2L08-G03	22		21.8	27.2	26.5	55.6			
ø10	1/8	KQB2L10-G01	14	16.6	13.8	20	22.7	25.5	17	35.2	25.7
	1/4	KQB2L10-G02	19		17.8	26.1	27.9	38.2			
	3/8	KQB2L10-G03	22		21.8	21	28.6	29.4			56.2
	1/2	KQB2L10-G04	27		26.5	32.6	31.9	97.9			
ø12	1/4	KQB2L12-G02	19	18.7	17.8	22.6	27.2	30	18.6	50.2	41.9
	3/8	KQB2L12-G03	22		21.8	23.6	29.6	31.4			54.3
	1/2	KQB2L12-G04	27		26.5	33.6	33.9	94.6			
ø16	3/8	KQB2L16-G03	22	24.6	21.8	26.3	32.4	36.5	20.8	71	64.7
	1/2	KQB2L16-G04	27		26.5	27.3	36.4	39			100

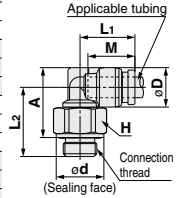

Note 1) øD is maximum diameter.  
 Note 2) Value of FEP tubing.  
 Value of nylon tubing for ø16 only.

### Male Branch Tee: KQB2T



Applicable tubing O.D. (mm)	Connection thread G	Model	H (Width across flat)	Note 1) øD	ød	L1	L2	A	M	Note 2) Effective area (mm <sup>2</sup> )	Weight (g)
ø4	1/8	KQB2T04-G01	14	9.1	13.8	14.4	18.9	17.9	12.6	6	17.5
	1/4	KQB2T04-G02	19		17.8	22.3	20.3	34.9			
ø6	1/8	KQB2T06-G01	14	11.4	13.8	20	20.2	13.6	13.9	21	
	1/4	KQB2T06-G02	19		17.8	15.9	23.4			22.6	38
	3/8	KQB2T06-G03	22		21.8	25.9	24.1			57.9	
ø8	1/8	KQB2T08-G01	14	13.7	13.8	18.6	21.3	22.6	16.1	26.3	25.6
	1/4	KQB2T08-G02	19		17.8	19.1	24.7	25			41.2
	3/8	KQB2T08-G03	22		21.8	27.2	26.5	60.8			
ø10	1/8	KQB2T10-G01	14	16.6	13.8	20	22.7	25.5	17	40.8	34
	1/4	KQB2T10-G02	19		17.8	26.1	27.9	46			
	3/8	KQB2T10-G03	22		21.8	21	28.6	29.4			64
	1/2	KQB2T10-G04	27		26.5	32.6	31.9	105.8			
ø12	1/4	KQB2T12-G02	19	18.7	17.8	22.6	27.2	30	18.6	57.2	53
	3/8	KQB2T12-G03	22		21.8	23.6	29.6	31.4			54.3
	1/2	KQB2T12-G04	27		26.5	33.6	33.9	105			
ø16	3/8	KQB2T16-G03	22	24.6	21.8	26.3	32.4	36.5	20.8	71	82.2
	1/2	KQB2T16-G04	27		26.5	27.3	36.4	39			100

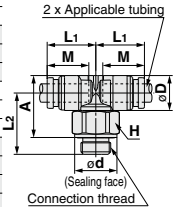

Note 1) øD is maximum diameter.  
 Note 2) Value of FEP tubing.  
 Value of nylon tubing for ø16 only.

- KQ2**
- KQB2**
- KS**
- KX**
- KM**
- KF**
- M**
- H/DL**
- L/LL**
- KC**
- KK**
- KK130**
- DM**
- KDM**
- KB**
- KR**
- KA**
- KQG2**
- KG**
- KFG2**
- MS**
- KKA**
- KP**
- LQ**
- MQR**
- T**
- IDK**

# KQB2 Series

Applicable Tubing: Metric Size, Connection Thread: G

Tubing One-touch fittings  
Plug-in reducer/Plug

Tubing Tubing  
Union elbow/Union tee/Straight union etc.

Refer to page 141 and after for details.

## Dimensions

### Bulkhead Connector: KQB2E



Applicable tubing O.D. (mm)	Connection thread G	Model	T (M)	Width across flat		L1	L2	Mounting hole	M	Note 1) Effective area (mm <sup>2</sup> )	Weight (g)
				H1	H2						
ø4	1/8	KQB2E04-G01	M10 x 1	17	12	27.1	11	11	12.6	5.6	25.1
	1/4	KQB2E04-G02		19		32.7	16.6				36.9
	3/8	KQB2E06-G01		17		25.5	7.4				26.8
ø6	1/4	KQB2E06-G02	M14 x 1	19	17	33.5	15.4	15	13.6	13.1	42.7
	3/8	KQB2E06-G03		24		35	16.9				62
	1/8	KQB2E08-G01		17		27.6	8.2				30.4
ø8	1/4	KQB2E08-G02	M15 x 1	19	19	34.5	15.1	16	16.1	26.1	43.9
	3/8	KQB2E08-G03		24		36	16.6				66.2
	1/8	KQB2E10-G02		19		33.5	13.5				46.8
ø10	3/8	KQB2E10-G03	M18 x 1	24	21	35.6	15.6	19	17	41.5	65.4
	1/4	KQB2E12-G03		24		35.9	14.7				119.2
	1/2	KQB2E12-G04		27		42.2	21				91.9
ø12	3/8	KQB2E16-G03	M20 x 1	24	24	37.2	13.1	21	18.6	58.3	118.2
	1/2	KQB2E16-G04		29		43.1	19				91.9
	3/8	KQB2E16-G03		29		43.1	19				128.7

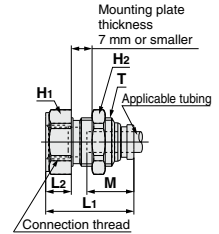

Note 1) Value of FEP tubing.  
Value of nylon tubing for ø16 only.

### Extended Male Union: KQB2W



Applicable tubing O.D. (mm)	Connection thread G	Model	H (Width across flat)	Note 1) øD	ød	L1	L2	A	M	Note 2) Effective area (mm <sup>2</sup> )	Weight (g)	
												ø4
1/4	KQB2W04-G02	19		17.8		38.7	36.7	70.6				
ø6	1/8	KQB2W06-G01	14	11.4	13.8		36.4	36.6	13.6	10.9	36.1	
	1/4	KQB2W06-G02	19		17.8	15.9	39.8	39			72.2	
	3/8	KQB2W06-G03	22			21.8		42.3			40.5	106.7
ø8	1/4	KQB2W08-G01	14	13.7	13.8	18.6	40	41.3	16.1	20.5	41.3	
	1/8	KQB2W08-G02	19		17.8		43.4	43.7			76.7	
	3/8	KQB2W08-G03	22			21.8	19.1	45.9			45.2	112.9
ø10	1/4	KQB2W10-G02	19	16.6	17.8		49.8	51.6	17	33.5	84.8	
	3/8	KQB2W10-G03	22		21.8	21	50.2	51			116.6	
	1/2	KQB2W10-G04	27			26.5		54.2			53.5	196.6
ø12	1/4	KQB2W12-G02	19	18.7	17.8	22.6	50.9	53.7	18.6	47.7	88.7	
	3/8	KQB2W12-G03	22		21.8		53.3	55.1			111.6	
	1/2	KQB2W12-G04	27			26.5	23.6	57.3			57.6	193.8
ø16	3/8	KQB2W16-G03	22	24.6	21.8	26.3	62	66.1	20.8	71	133.6	
	1/2	KQB2W16-G04	27			26.5	27.3	66			68.6	201.6

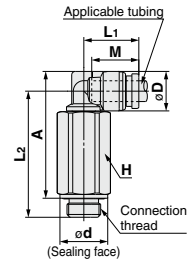

Note 1) øD is maximum diameter.  
Note 2) Value of FEP tubing.  
Value of nylon tubing for ø16 only.

### Female Connector: KQB2F



Applicable tubing O.D. (mm)	Connection thread G	Model	H (Width across flat)	Note 1) øD	L1	L2	M	Note 2) Effective area (mm <sup>2</sup> )	Weight (g)	
										ø4
1/4	KQB2F04-G02	19		30.6	14.5	32				
ø6	1/8	KQB2F06-G01	17	11.1	25.5	9.7	13.6	13.1	22.6	
	1/4	KQB2F06-G02	19		31.1	14.7			33	
	3/8	KQB2F06-G03	24			32.6			14.6	51.1
ø8	1/8	KQB2F08-G01	17	13.4	27.6	10	16.1	26.1	25.1	
	1/4	KQB2F08-G02	19		33.2	14.9			36.3	
	3/8	KQB2F08-G03	24			34.6			14.7	53.8
ø10	1/4	KQB2F10-G02	19	16.4	33.5	15.2	17	41.5	39.9	
	3/8	KQB2F10-G03	24			34.9			15	57.7
	1/4	KQB2F12-G02	19		34.5	15.2			41.8	
ø12	3/8	KQB2F12-G03	24	18.5	35.9	15	18.6	58.3	59.7	
	1/2	KQB2F12-G04	27			41.8			19.9	81.6
	3/8	KQB2F16-G03	24			37.2			15.4	66.6
ø16	1/2	KQB2F16-G04	27	24.6	43.1	20.4	20.8	113	89.1	

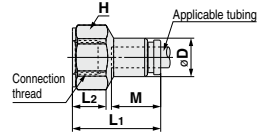

Note 1) øD is maximum diameter.  
Note 2) Value of FEP tubing.  
Value of nylon tubing for ø16 only.

## Related Equipment

### Spatter cover

(Applicable tubing: FR soft nylon, FR double layer, FR three-layer)



Applicable tubing O.D. (mm)	Model
ø6	KQB2-06C-X1124
ø8	KQB2-08C-X1124
ø10	KQB2-10C-X1124

\* Since the spatter cover is designed for multi-layer (double layer, three-layer) tubing, sufficient effects cannot be obtained in foreign matter flow-in or followability for singlelayer tubing.

\* The cover can be attached regardless of the single-layer/multi-layer tubing.

\* Cannot be used for union "Y" (KQB2U) 2-port side.



# KQB2 Series

## Specific Product Precautions

Be sure to read this before handling the products.

Refer to back page 50 for Safety Instructions and pages 13 to 17 for Fittings and Tubing Precautions.

### Selection

#### ⚠ Caution

1. The surge pressure must be under the maximum operating pressure. If the surge pressure exceeds the maximum operating pressure, it will result in damage to fittings and tubing or the tubing may result in being fallen out.
2. If using a fluororesin tubing in an environment where the fluid temperature changes drastically, it is recommended to use an inner sleeve. Otherwise, air leakage may occur or the tube may release from fitting due to deformation of the tubing.
3. The particle generation of the KQB2 series depends on the operating conditions and operating environment. If you are concerned about the effects on machinery and equipment, check the particle generation with your machine before use.

The components of the KQB2 series may slide due to changes in the internal pressure, which may generate particles. When using male elbow, male branch tee, and extended male elbow fittings, particles may be generated by rotation for positioning after connecting.

### Mounting

#### ⚠ Caution

1. When performing the piping work, turn the tightening tool in the horizontal direction to the hex across flats of the stud so that any moment is not applied to the body.

If the tool is in contact with the body, this may cause the stud to come off.

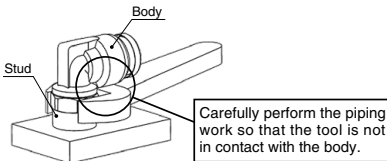

2. The union elbow, union tee, union "Y", different diameter tee and different diameter union "Y" should be fixed through the mounting hole.

Otherwise, air leakage or breaking can occur due to a pulling force or moment load created by the product's weight.

3. The elbow union, branch tee, and long elbow union can be turned for positioning after connecting, but they cannot be used while turning them.

Doing so may cause worn out metallic particles to enter the fluid or the fitting to break.

4. If the connection tube oscillates or turns, do not use this product.

Doing so may cause the fitting to break. In particular, for the product with the stud, this may cause the stud to come off.

### Installation and Removal of Tubing

#### ⚠ Caution

1. Installation of tubing

1) Grease is not used for the KQB2 series, therefore a greater insertion force is required when the tube is installed. In particular, polyurethane tubing may fold when inserted due to its softness. Hold the end of the tubing, and insert it all the way in slowly and securely. Refer to dimension "M" in the dimension drawings for guidance on the insertion depth of tubing.

2. Removal of tubing

1) For tubing used at a high temperature or for an extended period of time, there is a possibility that it will not fit into a One-touch fitting again due to an enlarged O.D. Dispose of the tubing and replace it with a new one.

### Proper Tightening Torque of Fittings

#### ⚠ Caution

1. Tighten fittings with sealant using the proper tightening torques in the table below. As a rule, they should be tightened 2 to 3 turns with a tool after first tightening by hand.

If tightened using a torque exceeding the proper torque level, this may cause the fitting to break.

In particular, for the product with the stud, the stud may come off.

#### R thread/NPT thread Proper tightening torque

Connection thread size	Proper tightening torque N·m
NPT, R1/8	3 to 5
NPT, R1/4	8 to 12
NPT, R3/8	15 to 20
NPT, R1/2	20 to 25

#### G thread Proper tightening torque

Connection thread size	Proper tightening torque N·m
G1/8	2.9 to 3.2
G1/4	5.7 to 6.3
G3/8	9.5 to 10.5
G1/2	14.3 to 15.8

KQ2

KQB2

KS  
KX

KM

KF

M

H/DL  
L/LL

KC

KK

KK130

DM

KDM

KB

KR

KA

KQG2

KG

KFG2

MS

KKA

KP

LQ

MQR

T

IDK